

TRS
INSTRUMENTS



CATALOG

NASAL SPECULUM



Anatomy
Other products



Page **1 - 38**



Scissors



Page **39 - 74**



TC-Scissors



Page **75 - 90**

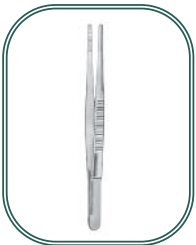

Forceps



Page **91 - 116**



TC-Forceps



Page **117 - 122**



Forceps, Clamps, Clips



Page **123 - 192**



Retractors

06

Page 193 - 252



Needle Holders

07

Page 253 - 270



TC Needle Holders

08

Page 271 - 288



NEURO

09

Page 289 - 304



ENT-Instruments

10

Page 305 - 340



ENT-Instruments

11

Page 341 - 364



Thorax and Lung Instruments

12

Page 365 - 386

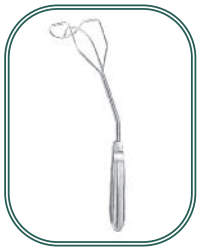

Cardiovascular

13

Page 387 - 406



Stomach Intestinal Rectum

14

Page 407 - 426



Liver, Gall Bladder, Kidney

15

Page 427 - 432



Gynecology

16

Page 433 - 466



Genito-Urinary

17

Page 467 - 474

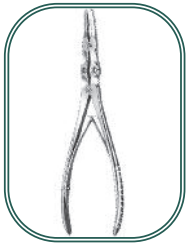

Bone Surgery

18

Page 475 - 556

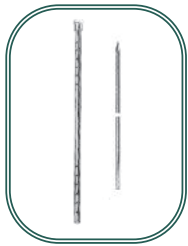

Kirschner Wire

19

Page 557 - 560



Drills/Screw Driver

20

Page 561 - 564



Hand/Foot Instruments

21

Page 565 - 568



Bandage and Plaster Instruments

22

Page 569 - 578



Nail and Care Instruments

23

Page 579 - 584



Bowls, Dishes, Boxes

24

Page 585 - 590



Sterilization

25

Page 591 - 594



00

Diagnostics

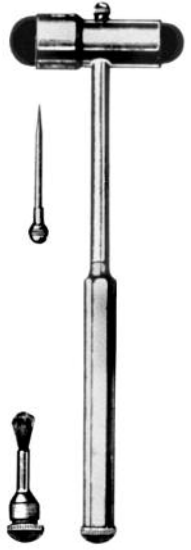

Buck
18,0 cm TR-00-000-18



Dejerine
20,0 cm TR-00-001-20



Dejerine
20,0 cm TR-00-002-21



Taylor
17,0 cm TR-00-003-17
20,0 cm TR-00-003-20



Berliner
17,0 cm TR-00-004-17



Troemner
23,0 cm TR-00-005-24



Babinsky
22,0 cm TR-00-006-22



Rabiner
23,0 cm TR-00-006-23

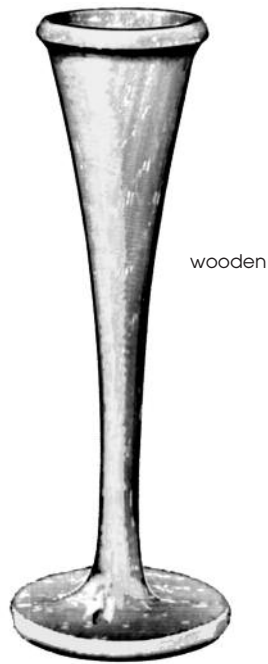

wooden

Pinard

18,0 cm TR-00-010-01



Aluminium

Pinard

15,0 cm TR-00-010-02



Ø 47 mm adults
Ø 37 mm children
Ø 22 mm baby

Duplex



TR-00-012-01

TR-00-012-02

TR-00-012-03



TR-00-013-00 Ø 47 mm



Pinwheel

Wartenberg
18,0 cm TR-00-015-18



Berillon Cephalometer
32,0 cm TR-00-020-01

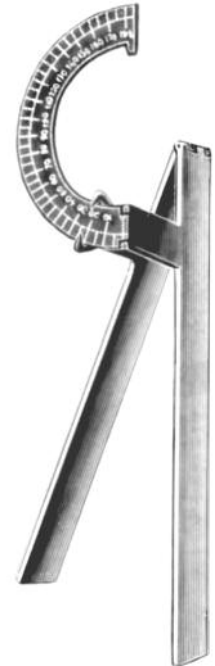

Moeltgen Goniometer
TR-00-021-01

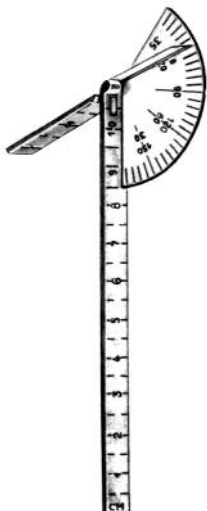

Caroll Finger-Goniometer
14,0 cm TR-00-022-14



Collin Dynamometer
12,0 cm TR-00-024-01
adults
12,0 cm TR-00-024-02
children

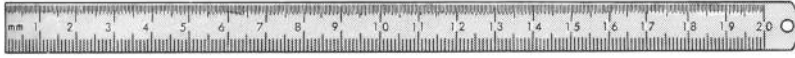

Rulers, metal

- 10,0 cm **TR-00-032-10**
- 15,0 cm **TR-00-032-15**
- 20,0 cm **TR-00-032-20**
- 30,0 cm **TR-00-032-30**
- 50,0 cm **TR-00-032-50**
- 100,0 cm **TR-00-032-99**

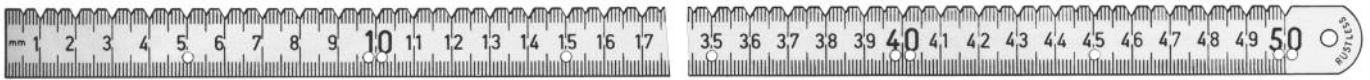

Rulers, metal (x-ray)

- 50,0 cm **TR-00-033-50**



Caliper of steel
TR-00-036-15



Vaccination lanzet
12,0 cm, **TR-00-042-12**

Head Mirrors, Head Lights



Head mirror, complete
TR-00-044-01



Head band, black
TR-00-044-10

Head band, white
TR-00-044-11



Head mirror
Ø 90 mm **TR-00-044-98**



Head mirror with cover
Ø 90 mm **TR-00-044-99**



Head lights, 6 Volt
TR-00-048-06



Spare bulb, 6 Volt
TR-00-048-26



Mirror of glass
TR-00-048-99



Transformer, 220 Volt
TR-00-049-00

Warm light

Fiberoptic

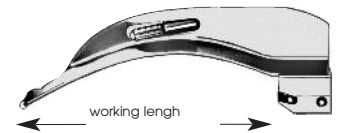

Miller

working length

55 mm Fig. 0	TR-00-051-00	TR-00-055-00
80 mm Fig. 1	TR-00-051-01	TR-00-055-01
130 mm Fig. 2	TR-00-051-02	TR-00-055-02
170 mm Fig. 3	TR-00-051-03	TR-00-055-03
180 mm Fig. 4	TR-00-051-04	TR-00-055-04



Mc Intosh

working length

55 mm Fig. 0	TR-00-052-00	TR-00-054-00
70 mm Fig. 1	TR-00-052-01	TR-00-054-01
90 mm Fig. 2	TR-00-052-02	TR-00-054-02
110 mm Fig. 3	TR-00-052-03	TR-00-054-03
130 mm Fig. 4	TR-00-052-04	TR-00-054-04



Wisconsin-Foregger

75 mm Fig. 00	TR-00-053-00
90 mm Fig. 0	TR-00-053-01
110 mm Fig. 1	TR-00-053-02
140 mm Fig. 2	TR-00-053-03
170 mm Fig. 3	TR-00-053-04



Warm light



Fiberoptic



Battery Handle
Ø 18 mm **TR-00-060-00** Ø 30 mm **TR-00-062-00**

Battery Handle
Ø 18 mm **TR-00-064-00** Ø 30 mm **TR-00-065-00**

Set warm light

Set Fiberoptic



Miller

TR-00-073-00

consisting of:
1 (handle) 00-062-00
je 1 (spatula) Fig. 1-2

TR-00-083-00

consisting of:
1(handle) 00-065-00
je 1 (spatula) Fig. 1-2

TR-00-074-00

consisting of:
1 (handle) 00-062-00
je 1 Spatel (spatula) Fig. 1-4
1 /case

TR-00-084-00

consisting of:
1(handle) 00-065-00
je 1 Spatel (spatula) Fig. 1-4
1/case



Mc Intosh

TR-00-076-00

consisting of:
1 (handle) 00-062-00
je 1 (spatula) Fig. 1-3

TR-00-081-00

consisting of:
1 (handle) 00-064-00
je 1 (spatula) Fig. 1-3

TR-00-077-0 0

consisting of:
1 (handle) 00-062-00
je 1 Spatel (spatula) Fig. 1-4
1/case

TR-0-082-00

consisting of:
1 (handle) 00-064-00
je 1 Spatel (spatula) Fig. 1-4
1/case



Wisconsin-Foregger

TR-00-079-00

consisting of:
1 (handle) 00-062-00
je 1 Spatel (spatula) Fig. 0-3
1 /case



Standard, Nr. 3
TR-00-103-01



Nr. 3
S-00-103-03



Nr. 3 L
TR-00-103-04



Nr. 7
TR-00-103-06



Nr. 7 K
TR-00-103-07

Skalpel Handles, No.4



Standard, Nr. 3 und 4
TR-00-104-00



Standard, Nr. 4
TR-00-104-01



Nr. 4 L
TR-00-104-04



Collin, Nr. 8
TR-00-104-06

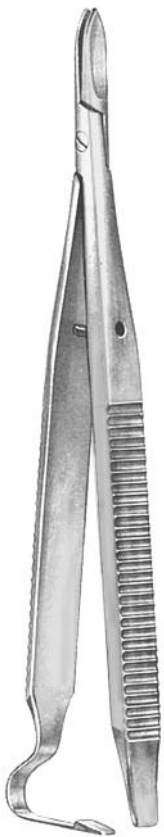

Blade Holder with ratchet
11,0 cm **TR-00-112**
-11

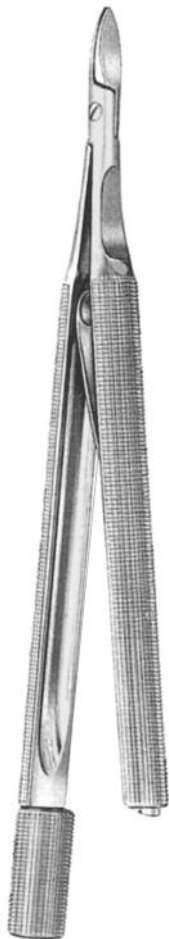

Blade Breaker and Holder
TR-00-114-13



Troutman-Christ
10,0 cm **TR-00-110-10**

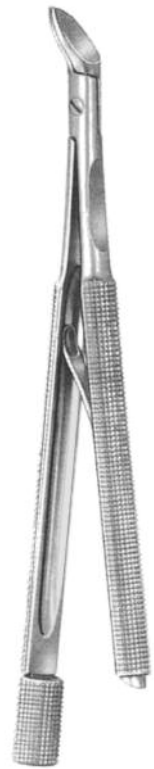

Troutman-Christ
10,0 cm **TR-00-111-10**

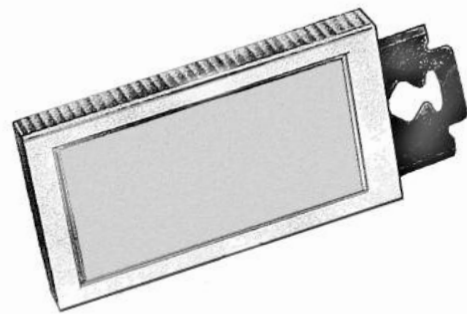

Blades pack. = 10 Blades
TR-00-116-00



Fig. 10
TR-00-153-10



Fig. 11
TR-00-153-11



Fig. 12
TR-00-153-12



Fig. 15
TR-00-153-15

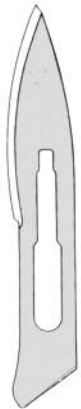

Fig. 18
TR-00-153-18



Fig. 19
TR-00-153-19



Fig. 20
TR-00-153-20



Fig. 21
TR-00-153-21



Fig. 22
TR-00-153-22

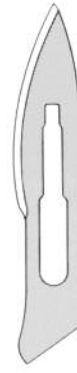

Fig. 23
TR-00-153-23



Fig. 24
TR-00-153-24



Fig. 25
TR-00-153-25



Fig. 36
TR-00-153-36

1 Pack. = 100 /pieces



Dissecting Knives



Fig.1
TR-00-302-01



Fig. 2
TR-00-302-02



Fig. 3
TR-00-302-03



Fig. 4
TR-00-302-04



Fig. 5
TR-00-302-05



Fig. 6
TR-00-302-06



Fig. 7
TR-00-302-07



Fig. 8
TR-00-302-08



Fig. 9
TR-00-302-09



Fig. 1
TR-00-304-01



Fig. 2
TR-00-304-02



Bergmann

Scalpels



Dieffenbach



Fig. 1
TR-00-308-01



Fig. 2
TR-00-308-02



Fig. 3
TR-00-308-03



Fig. 4
TR-00-308-04



Fig. 5
TR-00-308-05



Fig. 6
TR-00-308-06



Fig. 7
TR-00-308-07



Fig. 8
TR-00-308-08



Fig. 9
TR-00-308-09



Fig. 15
TR-00-308-15



Fig. 16
TR-00-308-16



Dissecting Scalpels



Fig. 1
TR-00-310-01



Fig. 2
TR-00-310-02



Fig. 3
TR-00-310-03



Fig. 4
TR-00-310-04



Fig. 5
TR-00-310-05



Fig. 6
TR-00-310-06



Fig. 7
TR-00-310-07



Fig. 8
TR-00-310-08



Fig. 9
TR-00-310-09



Fig. 10
TR-00-310-10

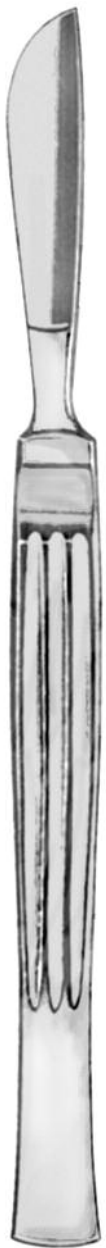

Fig. 1

TR-00-314-01



Fig. 2

TR-00-314-02



Fig. 3

TR-00-314-03



Fig. 4

TR-00-314-04



Fig. 5

TR-00-314-05



Fig. 6

TR-00-314-06



Fig. 7

TR-00-314-07



Fig. 8

TR-00-314-08



Fig. 9

TR-00-314-09



Fig. 1

TR-00-316-01



Fig. 2

TR-00-316-02



Fig. 3

TR-00-316-03



Fig. 4

TR-00-316-04



Fig. 5

TR-00-316-05



Fig. 6

TR-00-316-06



Fig. 7

TR-00-316-07



Fig. 8

TR-00-316-08



Fig. 9

TR-00-316-09

double cutting



Liston



Catlin



Langenbeck



Phalangeal knife

double cutting



Interosseous knife



Periosteum knife

S=13 cm **TR-00-320-13**
S=16 cm **TR-00-320-16**
S=19 cm **TR-00-320-19**
S=22 cm **TR-00-320-22**

TR-00-322-16
S=16 cm

TR-00-324-12
S=12 cm

TR-00-326-10
S=10,5 cm

TR-00-328-11
S=10,5 cm

TR-00-330-06
S=6,5 cm

S=length of blades



Langenbeck Fig. 1
S=5,5 cm **TR-00-332-01**



Langenbeck Fig. 2
S=5,5 cm **TR-00-332-02**



Wooden handle

Cartilage knife
S=5,5 cm **TR-00-334-01**



Cartilage knife
S=7,0 cm **TR-00-334-02**



Virchow
S=8,5 cm **TR-00-338-08**

S=length of blades



Wooden handle

Virchow

TR-00-340-09
S=9,5 cm



Virchow

TR-00-340-11
S=11,5 cm



Autopsy knife

S=10,0 cm TR-00-344-10
S=13,0 cm TR-00-344-13



Autopsy knife

TR-00-344-19
S=19,5 cm



Post mortem knife

S=11,0 cm TR-00-350-11
S=14,0 cm TR-00-350-14
S=17,0 cm TR-00-350-17



Brain knife

S=16,0 cm TR-00-360-16
S=20,0 cm TR-00-360-20
S=24,0 cm TR-00-360-24

S=length of blades



20,0 cm



Fig. 1
TR-00-362-01



Fig. 2
TR-00-362-02



Fig. 3
TR-00-362-03

Simon



Ulrich
22,5 cm TR-00-364-22



Ayre
22,5 cm TR-00-365-23



Schröder
22,5 cm TR-00-366-20



Segond
26,5 cm TR-00-368-26



Segond
27,0 cm TR-00-368-27



Olivecrona
Trigeminal knife
20,0 cm **TR-00-369-20**



Trigeminal knife
23,0 cm **TR-00-370-23**



Fowler
Tonsil knife
20,0 cm **TR-00-371-20**



Abraham
Tonsil knife
21,5 cm **TR-00-371-21**



Brünings
Tonsil knife
21,5 cm **TR-00-371-22**

Scalpels



Abscess Knife
13,0 cm **TR-00-374-13**



Ziegler
Dura knife



Fig. 1

12,0 cm **TR-00-378-01**



Fig. 2

TR-00-378-02



Fig. 3

TR-00-378-03



Tönnis
Dura Knife
13,0 cm **TR-00-380-13**



Halle
Dura Knife
21,0 cm **TR-00-382-21**



Schink
Dermatome, complete
30,0 cm **TR-00-400-00**



Spare blade
TR-00-400-01

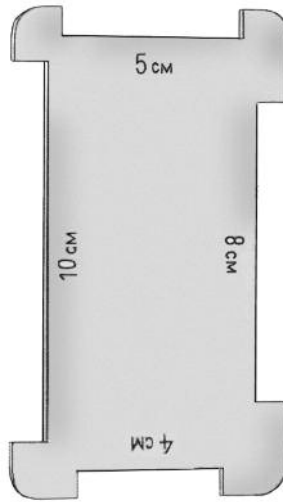

Skin straightening plate
TR-00-400-02



Silver
Dermatome
19,0 cm **TR-00-402-19**



Razor
S=8,0 cm **TR-00-409-00**

S=length of blades



Spare blade
TR-00-410-99

Monocorps
Milium knife

14,0 cm TR-00-410-14



Vidal
Lupus scraper

14,0 cm TR-00-411-14



Fox
Lupus scraper

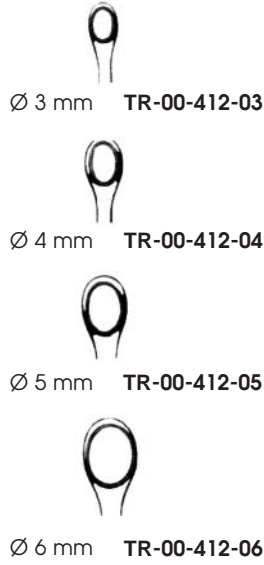

Wolff
Lupus scraper

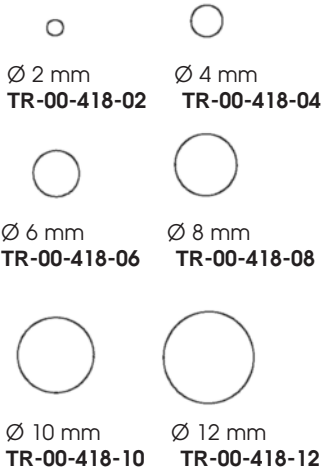
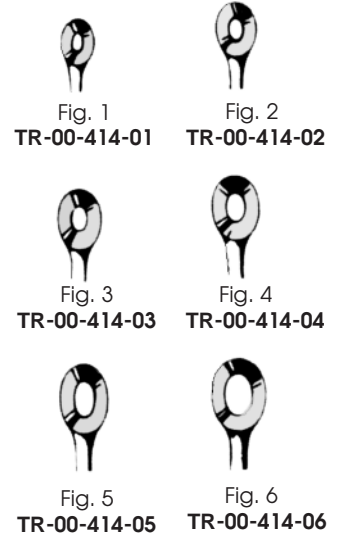

Skin trephine



Handle
8,0 cm TR-00-418-99

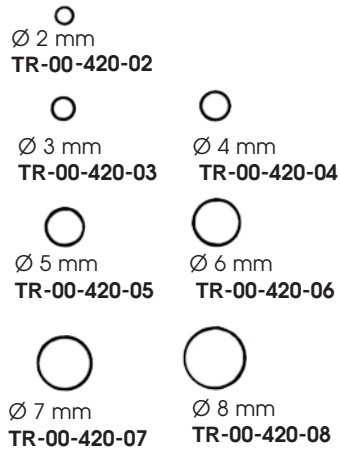

Keyes
Dermal punch

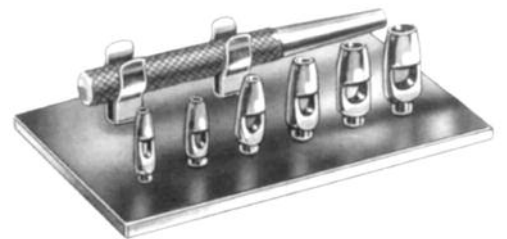

Keyes
Set complete
TR-00-422-00



Unna
14,5 cm TR-00-431-14



Unna
14,0 cm TR-00-433-14

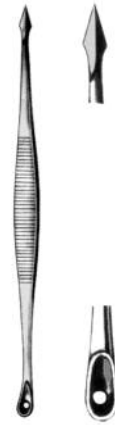

Saalfeld
11,0 cm TR-00-435-11

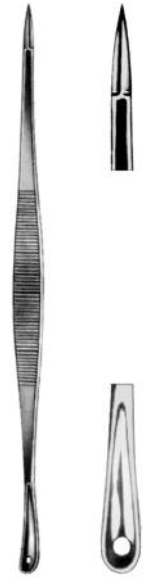

Saalfeld
14,5 cm TR-00-437-14



Schamberg
9,5 cm TR-00-439-09

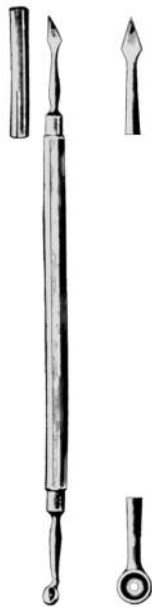

Katsch
14,0 cm TR-00-441-14



Unna-Vidal
11,5 cm TR-00-446-11



German silver

Probes

	Ø 1,0 mm	Ø 1,5 mm	Ø 2,0 mm
11,5 cm	TR-00-600-11	TR-00-601-11	TR-00-602-11
13,0 cm	TR-00-600-13	TR-00-601-13	TR-00-602-13
14,0 cm	TR-00-600-14	TR-00-601-14	TR-00-602-14
16,0 cm	TR-00-600-16	TR-00-601-16	TR-00-602-16
18,0 cm	TR-00-600-18	TR-00-601-18	TR-00-602-18
20,0 cm	TR-00-600-20	TR-00-601-20	TR-00-602-20
25,0 cm	TR-00-600-25	TR-00-601-25	TR-00-602-25

Probes with eye
Ø 2,0 mm

11,5 cm	TR-00-604-11
13,0 cm	TR-00-604-13
14,0 cm	TR-00-604-14
16,0 cm	TR-00-604-16
18,0 cm	TR-00-604-18
20,0 cm	TR-00-604-20

Myrtle leaf probes
Ø 2,0 mm

13,0 cm	TR-00-606-13
14,5 cm	TR-00-606-14
16,0 cm	TR-00-606-16
20,0 cm	TR-00-606-20

Stacke

10,5 cm	TR-00-608-1010
---------	----------------

Bowman

Fig.	
00/0	TR-00-609-01
1/2	TR-00-609-02
3/4	TR-00-609-03
5/6	TR-00-609-04



Directors

11,5 cm	TR-00-610-11
13,0 cm	TR-00-610-13
14,5 cm	TR-00-610-14
16,0 cm	TR-00-610-16
18,0 cm	TR-00-610-18



Directors with tip

	Ø 3,5 mm
13,0 cm	TR-00-612-13
14,5 cm	TR-00-612-14
16,0 cm	TR-00-612-16



Doyen

14,0 cm	TR-00-613-14
---------	--------------



Nélaton

16,0 cm	TR-00-615-16
---------	--------------



Brodie

Ø 3,5 mm

20 cm	TR-00-616-20
-------	--------------



Lockhart-Mummery
16,0 cm TR-00-618-16



Lockhart-Mummery
16,0 cm TR-00-619-16



Lockhart-Mummery
16,0 cm TR-00-621-16



Lockhart-Mummery
16,0 cm TR-00-623-16



Frontal Sinus Bougies

- Ø 2,5 mm TR-00-625-25
- Ø 3,0 mm TR-00-625-30
- Ø 4,0 mm TR-00-625-40
- Ø 5,0 mm TR-00-625-50



Farrell

- Ø 0,9 mm 12 cm TR-00-630-12
- Ø 0,9 mm 14 cm TR-00-630-
- Ø 1,1 mm 16 cm TR-00-630-
- Ø 1,2 mm 18 cm TR-00-630-18



Universal

- Ø 1,0 mm 12 cm TR-00-632-12
- Ø 1,0 mm 14 cm TR-00-632-
- Ø 1,2 mm 16 cm TR-00-632-
- Ø 1,2 mm 18 cm TR-00-632-18



Jobson-Horne

- 18,0 cm TR-00-636-18



Universal
Ø 2,5 mm

- 27,0 cm TR-00-638-27



Grasping Forceps
Schaff 38,0 cm **TR-00-640-45**

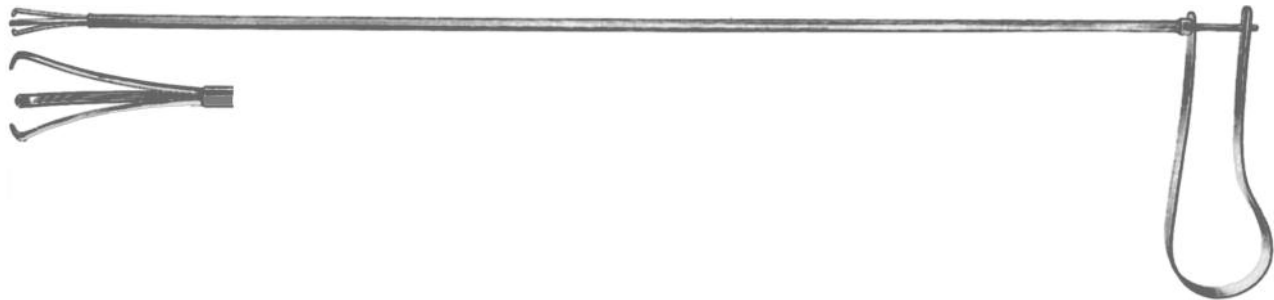

Grasping Forceps
Schaff 28,0 cm **TR-00-642-35**
Schaff 38,0 cm **TR-00-642-45**



Knife tip slightly curved



Charr.	
8	TR-00-701-08
10	TR-00-701-10
12	TR-00-701-12
14	TR-00-701-14
16	TR-00-701-16
18	TR-00-701-18



Knife tip strongly curved



Charr.	
8	TR-00-705-08
10	TR-00-705-10
12	TR-00-705-12
14	TR-00-705-14
16	TR-00-705-16
18	TR-00-705-18



Lanzet tip slightly curved



Charr.	
8	TR-00-709-08
10	TR-00-709-10
12	TR-00-709-12
14	TR-00-709-14
16	TR-00-709-16
18	TR-00-709-18

Trocars



Universal

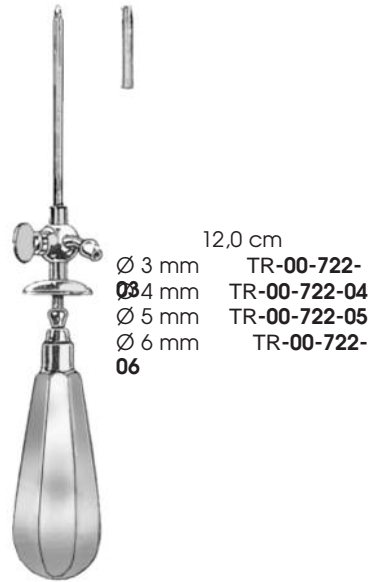

Standard

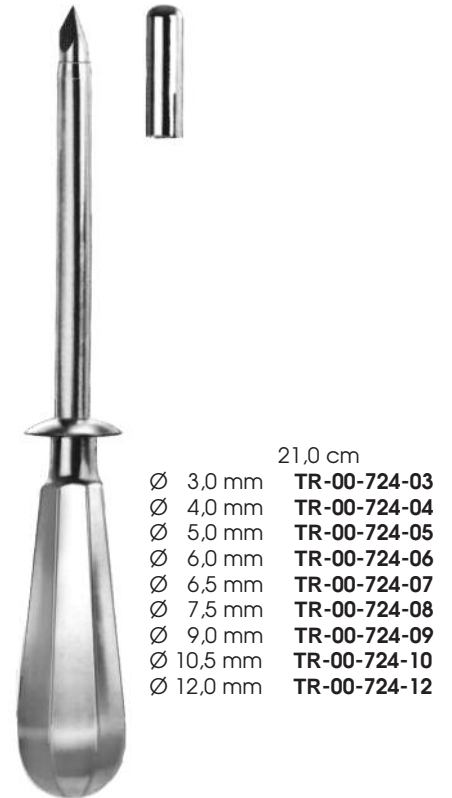

Nelson



Sinoskopie

Ø 3,5 mm **TR-00-726-35**



Buelau

Ø 8,0 mm **TR-00-728-08**
Ø 10,0 mm **TR-00-728-10**



Lichtwitz

Ø 1,75 mm **TR-00-730-18**



Pierce
Ø 4,0 mm
16,0 cm **TR-00-731-04**



Krause
Ø 4,0 m
16,0 cm **TR-00-733-04**



Duke
Ø 5,5 mm
11,0 cm **TR-00-734-05**



Ochsner
14,0 cm
Ø 4,0 mm **TR-00-736-40**
Ø 4,6 mm **TR-00-736-46**
Ø 5,3 mm **TR-00-736-53**
Ø 6,0 mm **TR-00-736-60**

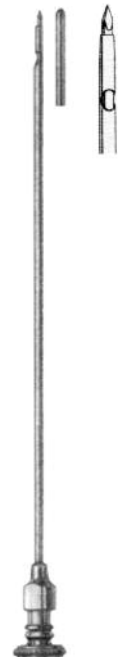

Landau
Ø 2,0 mm
17,0 cm **TR-00-738-02**



Douglas
Ø 3,0 mm
11,0 cm **TR-00-739-03**



Coakley
Ø 2,0 mm
14,0 cm **TR-00-741-03**

Special Needles

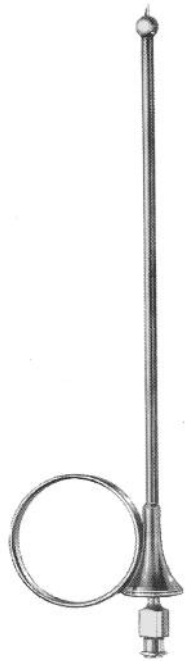

Pudendus Needle

14,0 cm **TR-00-802-00**



Vein Needle

1,20 mm **TR-00-804-12**
1,50 mm **TR-00-804-15**



straight



curved



angled



bayonet

Tonsil Needles

Ø 0,8 mm **TR-00-810-01** **TR-00-810-0** **TR-00-810-0** **TR-00-810-05**



Verres

Ø 2,0 mm
80 mm **TR-00-812-08**
100 mm **TR-00-812-10**
120 mm **TR-00-812-12**
130 mm **TR-00-812-13**
140 mm **TR-00-812-14**
150 mm **TR-00-812-15**



Menghini

Ø 1,0 x 35 mm **TR-00-814-01**
Ø 1,0 x 70 mm **TR-00-814-02**
Ø 1,2 x 70 mm **TR-00-814-03**
Ø 1,2 x 100 mm **TR-00-814-04**
Ø 1,4 x 70 mm **TR-00-814-05**
Ø 1,4 x 100 mm **TR-00-814-06**
Ø 1,6 x 70 mm **TR-00-814-07**
Ø 1,8 x 100 mm **TR-00-814-08**



Menghini

Ø 1,4 x 168 mm **TR-00-816-14**
Ø 1,8 x 168 mm **TR-00-816-18**



Vollmar

Ø 1,5 mm **TR-00-817-15**
Ø 2,0 mm **TR-00-817-20**
Ø 2,5 mm **TR-00-817-25**
Ø 3,0 mm **TR-00-817-30**
Ø 4,0 mm **TR-00-817-40**



Schmid

15,0 cm
Ø 3,0 mm **TR-00-818-03**
Ø 4,0 mm **TR-00-818-04**
Ø 5,0 mm **TR-00-818-05**
Ø 6,0 mm **TR-00-818-06**



Mock

1,5 mm x 8,0 cm **TR-00-820-08**

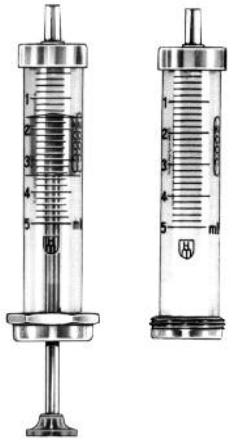

Luer

		Barrels
1 ml	TR-00-840-01	TR-00-842-01
2 ml	TR-00-840-02	TR-00-842-02
5 ml	TR-00-840-05	TR-00-842-05
10 ml	TR-00-840-10	TR-00-842-10
20 ml	TR-00-840-20	TR-00-842-20
50 ml	TR-00-840-50	TR-00-842-50

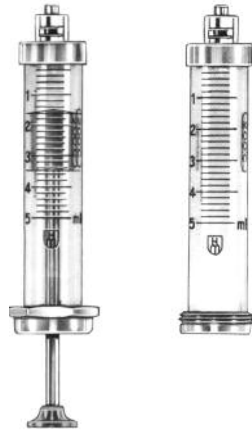

Luer-Lock

		Barrels
1 ml	TR-00-844-01	TR-00-846-01
2 ml	TR-00-844-02	TR-00-846-02
5 ml	TR-00-844-05	TR-00-846-05
10 ml	TR-00-844-10	TR-00-846-10
20 ml	TR-00-844-20	TR-00-846-20
50 ml	TR-00-844-50	TR-00-846-50



Luer-Lock

		Barrels
2 ml	TR-00-848-02	TR-00-850-02
5 ml	TR-00-848-05	TR-00-850-05
10 ml	TR-00-848-10	TR-00-850-10
20 ml	TR-00-848-20	TR-00-850-20



Janet

		Barrels
50 ml	TR-00-860-05	TR-00-862-05
100 ml	TR-00-860-10	TR-00-862-10
200 ml	TR-00-860-20	TR-00-862-20

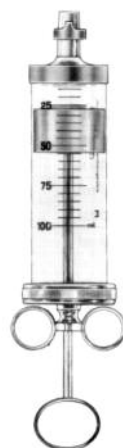

Janet G-S Record

		Barrels
50 ml	TR-00-864-05	TR-00-866-05
70 ml	TR-00-864-07	TR-00-866-07
100 ml	TR-00-864-10	TR-00-866-10
150 ml	TR-00-864-15	TR-00-866-15
200 ml	TR-00-864-20	TR-00-866-20
250 ml	TR-00-864-25	TR-00-866-25

TR-00-900-00

complete, consisting of:

- TR-00-900-01** suction tube, 14,0 cm
- TR-00-900-04** cannula \varnothing 0,4 mm
- TR-00-900-06** cannula \varnothing 0,6 mm
- TR-00-900-08** cannula \varnothing 0,8 mm



Wullstein

\varnothing 0,4 \varnothing 0,6 \varnothing 0,8

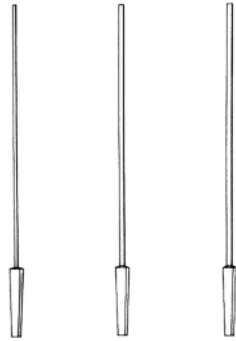

Frazier

19,0 cm

- 2,0 mm **TR-00-902-06**
- 2,3 mm **TR-00-902-07**
- 2,7 mm **TR-00-902-08**
- 3,0 mm **TR-00-902-09**
- 3,3 mm **TR-00-902-10**
- 3,6 mm **TR-00-902-11**
- 4,0 mm **TR-00-902-12**
- 5,0 mm **TR-00-902-15**



Plester

- 19,5 cm
- 1,5 mm **TR-00-903-04**
- 2,0 mm **TR-00-903-06**
- 2,5 mm **TR-00-903-07**
- 2,7 mm **TR-00-903-08**
- 3,0 mm **TR-00-903-09**
- 3,3 mm **TR-00-903-10**
- 3,6 mm **TR-00-903-11**
- 4,0 mm **TR-00-903-12**
- 5,0 mm **TR-00-903-15**



Frazier (Fergusson)

- 11,0 cm
- 2,0 mm **TR-00-904-06**
- 2,3 mm **TR-00-904-07**
- 2,7 mm **TR-00-904-08**
- 3,0 mm **TR-00-904-09**
- 3,3 mm **TR-00-904-10**
- 3,6 mm **TR-00-904-11**
- 4,0 mm **TR-00-904-12**
- 5,0 mm **TR-00-904-15**



Adson

- 21,0 cm
- \varnothing 4,0 mm **TR-00-905-04**

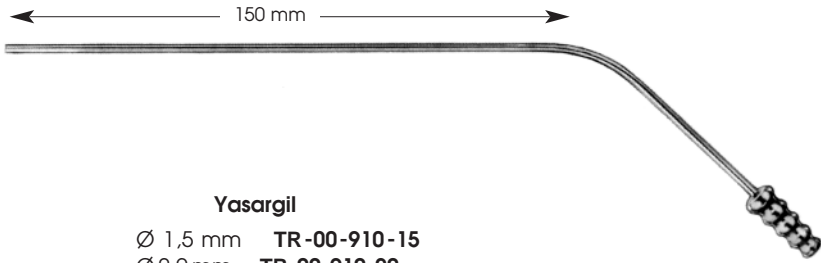

Yasargil
 Ø 1,5 mm **TR-00-910-15**
 Ø 2,0 mm **TR-00-910-20**
 Ø 2,5 mm **TR-00-910-25**
 Ø 3,5 mm **TR-00-910-35**



Yankauer
 Ø 10 mm
 27,0 cm **TR-00-911-02**



Suction Tube with outer tube
 Ø 10 mm
 22,0 cm **TR-00-914-10**



Suction Tube with outer tube
 Ø 8 mm
 22,0 cm **TR-00-915-08**

Ø 8 mm



Cooley

35.0 cm TR-00-917-08

Ø 10 mm



Cooley

31.0 cm TR-00-919-10

Ø 7 mm



Cooley

30.0 cm TR-00-921-07

Ø 8 mm

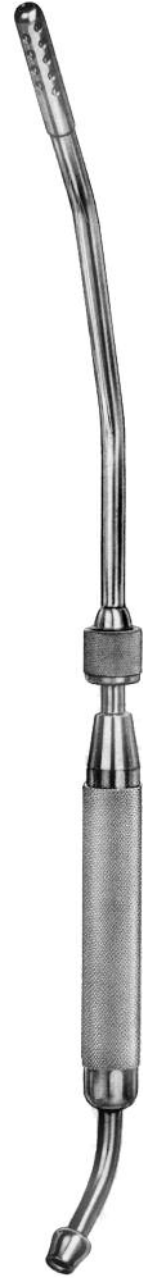

Cooley

33.0 cm TR-00-923-08

TRS INSTRUMENTS

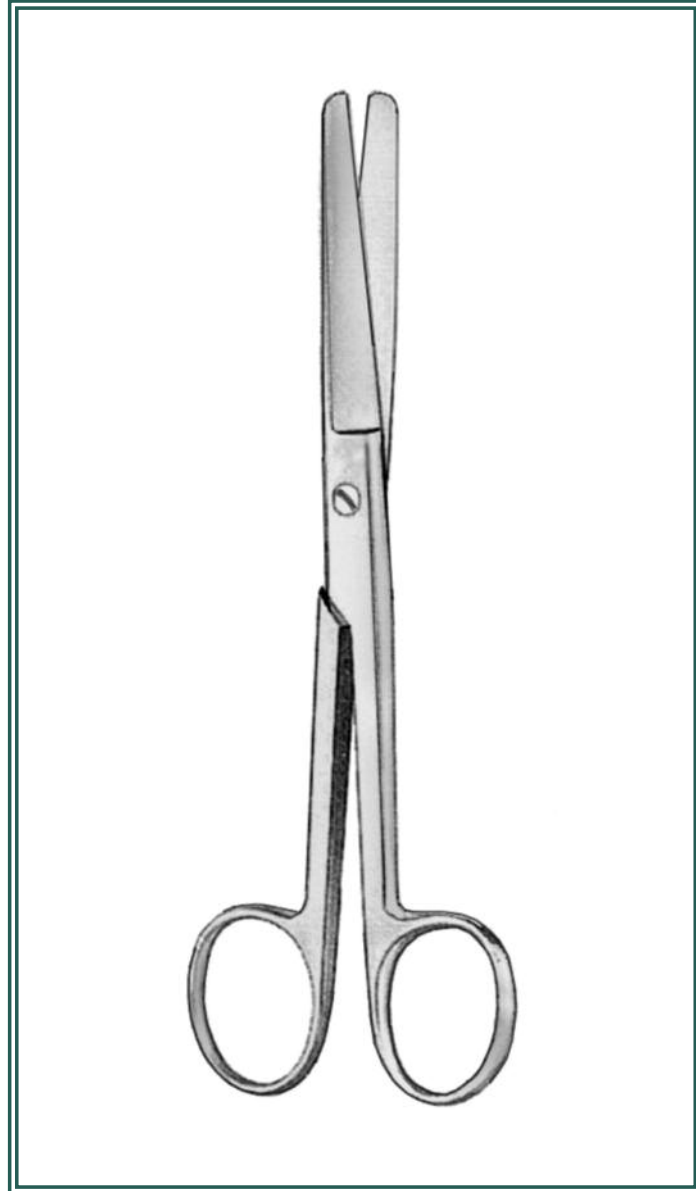

01

Sissors

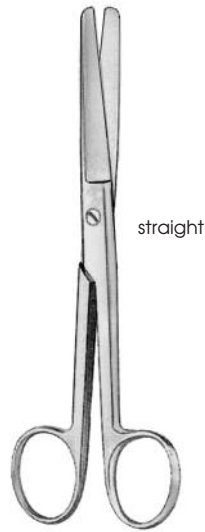

Standard,
Fig. 1

10,0 cm	TR-01-000-10
11,0 cm	TR-01-000-11
13,0 cm	TR-01-000-13
14,0 cm	TR-01-000-14
15,0 cm	TR-01-000-15
16,0 cm	TR-01-000-16
17,0 cm	TR-01-000-17
18,0 cm	TR-01-000-18
20,0 cm	TR-01-000-20

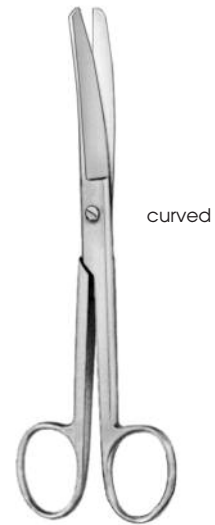

Standard,
Fig. 1

10,0 cm	TR-01-001-10
11,0 cm	TR-01-001-11
13,0 cm	TR-01-001-13
14,0 cm	TR-01-001-14
15,0 cm	TR-01-001-15
16,0 cm	TR-01-001-16
17,0 cm	TR-01-001-17
18,0 cm	TR-01-001-18
20,0 cm	TR-01-001-20

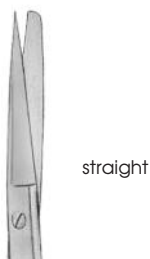

Standard
Fig. 2

10,0 cm	TR-01-002-10
11,0 cm	TR-01-002-11
13,0 cm	TR-01-002-13
14,0 cm	TR-01-002-14
15,0 cm	TR-01-002-15
16,0 cm	TR-01-002-16
17,0 cm	TR-01-002-17
18,0 cm	TR-01-002-18
20,0 cm	TR-01-002-20

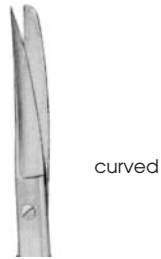

Standard
Fig. 2

10,0 cm	TR-01-003-10
11,0 cm	TR-01-003-11
13,0 cm	TR-01-003-13
14,0 cm	TR-01-003-14
15,0 cm	TR-01-003-15
16,0 cm	TR-01-003-16
17,0 cm	TR-01-003-17
18,0 cm	TR-01-003-18
20,0 cm	TR-01-003-20

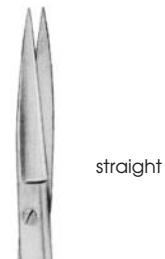

Standard
Fig. 3

10,0 cm	TR-01-004-10
11,0 cm	TR-01-004-11
13,0 cm	TR-01-004-13
14,0 cm	TR-01-004-14
15,0 cm	TR-01-004-15
16,0 cm	TR-01-004-16
17,0 cm	TR-01-004-17
18,0 cm	TR-01-004-18
20,0 cm	TR-01-004-20

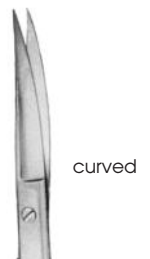

Standard
Fig. 3

10,0 cm	TR-01-005-10
11,0 cm	TR-01-005-11
13,0 cm	TR-01-005-13
14,0 cm	TR-01-005-14
15,0 cm	TR-01-005-15
16,0 cm	TR-01-005-16
17,0 cm	TR-01-005-17
18,0 cm	TR-01-005-18
20,0 cm	TR-01-005-20

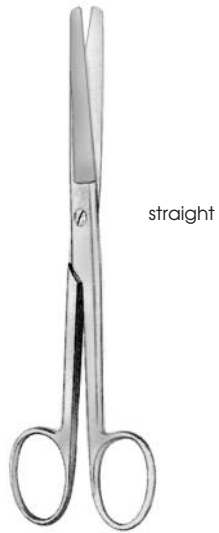

Fig. 1

13,0 cm **TR-01-010-13**
14,0 cm **TR-01-010-14**

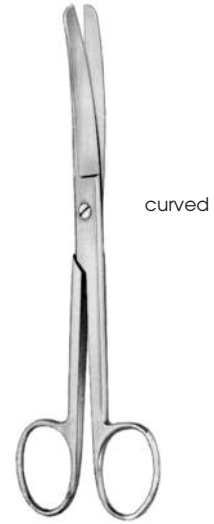

Fig. 1

13,0 cm **TR-01-011-13**
14,0 cm **TR-01-011-14**



grazil
Fig. 2

13,0 cm **TR-01-012-13**
14,0 cm **TR-01-012-14**

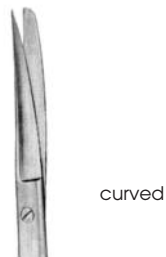

grazil
Fig. 2

13,0 cm **TR-01-013-13**
14,0 cm **TR-01-013-14**

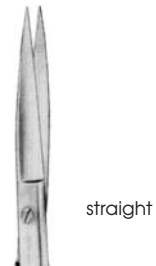

grazil
Fig. 3

13,0 cm **TR-01-014-13**
14,0 cm **TR-01-014-14**



grazil
Fig. 3

13,0 cm **TR-01-015-13**
14,0 cm **TR-01-015-14**

Operating Scissors



straight, 1 blade serrated

Scissors for wound edges
13,0 cm **TR-01-020-13**



curved, 1 blade serrated

Scissors for wound edges
13,0 cm **TR-01-021-13**

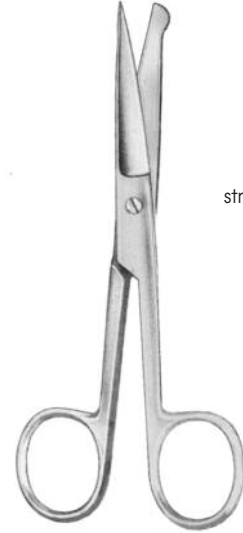

straight

13,0 cm **TR-01-100-13**
14,0 cm **TR-01-100-14**

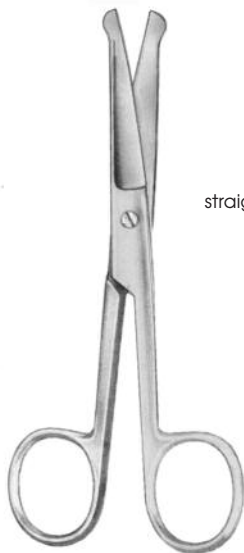

straight

15,0 cm **TR-01-102-15**

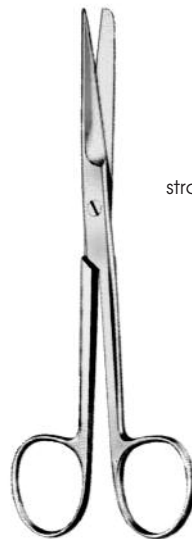

straight

Deaver
14,0 cm **TR-01-104-14**



curved

Deaver
14,0 cm **TR-01-105-14**



straight

Mixter

15,0 cm **TR-01-106-15**



curved

Mixter

15,0 cm **TR-01-107-15**



angled

Richter

14,0 cm **TR-01-109-14**



angled

Fergusson

18,0 cm **TR-01-111-18**

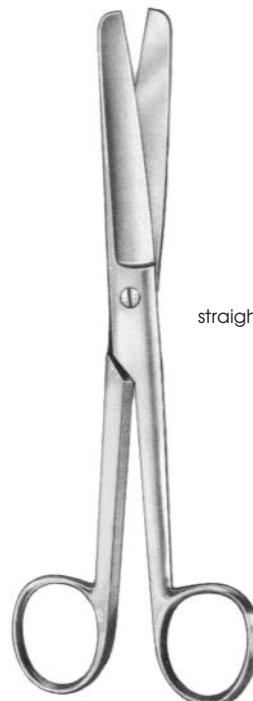

straight

Doyen

16,0 cm **TR-01-114-16**

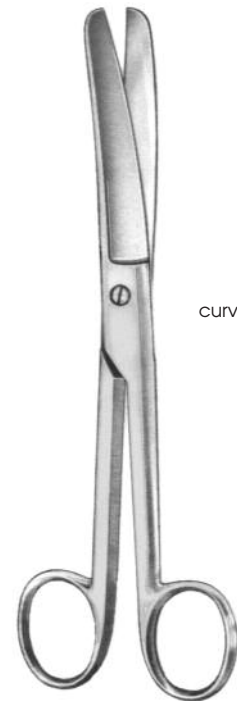

curved

Doyen

16,0 cm **TR-01-115-16**

Gynecological Scissors

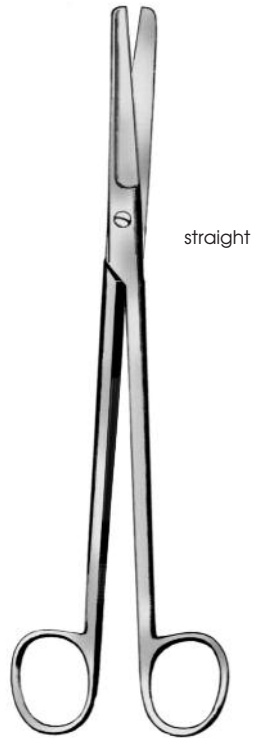

Sims
Fig. 1
20,0 cm **TR-01-120-20**
23,0 cm **TR-01-120-23**
25,0 cm **TR-01-120-25**

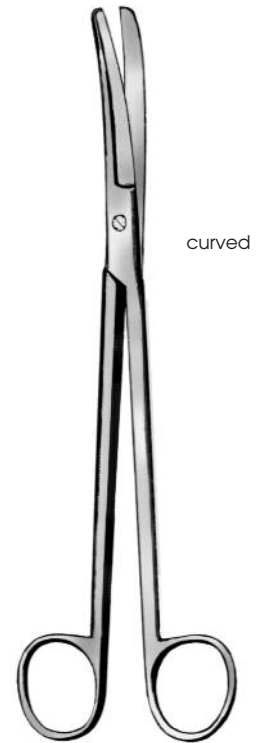

Sims
Fig. 1
20,0 cm **TR-01-121-20**
23,0 cm **TR-01-121-23**
25,0 cm **TR-01-121-25**



Sims
Fig. 2
20,0 cm **TR-01-122-20**
23,0 cm **TR-01-122-23**
25,0 cm **TR-01-122-25**



Sims
Fig. 2
20,0 cm **TR-01-123-20**
23,0 cm **TR-01-123-23**
25,0 cm **TR-01-123-25**



Sims
Fig. 3
20,0 cm **TR-01-124-20**
23,0 cm **TR-01-124-23**
25,0 cm **TR-01-124-25**

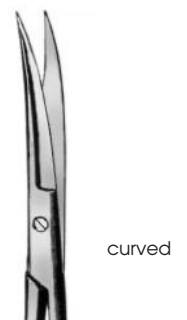

Sims
Fig. 3
20,0 cm **TR-01-125-20**
23,0 cm **TR-01-125-23**
25,0 cm **TR-01-125-25**



straight

Sims-Siebold
25,0 cm TR-01-126-25



s-shaped

Sims-Siebold
24,0 cm TR-01-127-24

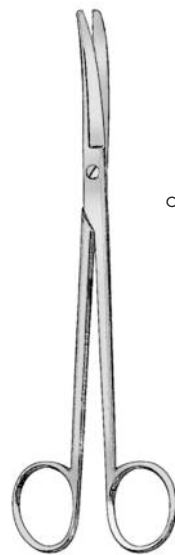

curved

Wertheim
14,0 cm TR-01-131-14
20,0 cm TR-01-131-20
22,0 cm TR-01-131-22

Scissors



straight

Dubois

27,0 cm **TR-01-132-27**



curved

Dubois

27,0 cm **TR-01-133-27**

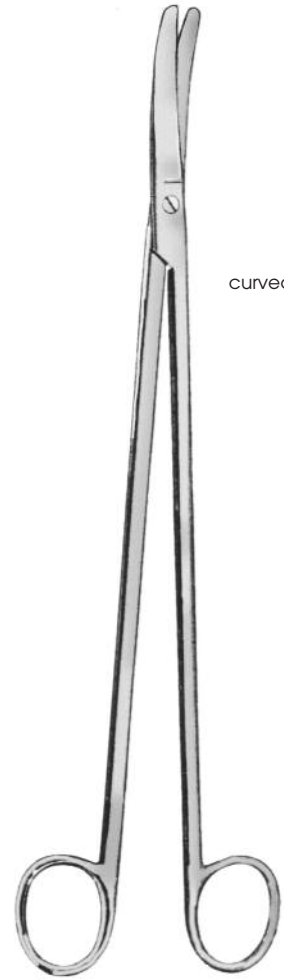

curved

Crafoord

30,0 cm **TR-01-137-30**



Braun-Stadler

14,0 cm **TR-01-139-14**
22,0 cm **TR-01-139-22**



Waldmann

18,0 cm **TR-01-141-18**

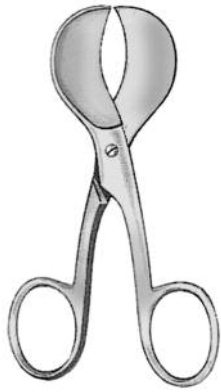

Modell USA
10,0 cm **TR-01-144-10**

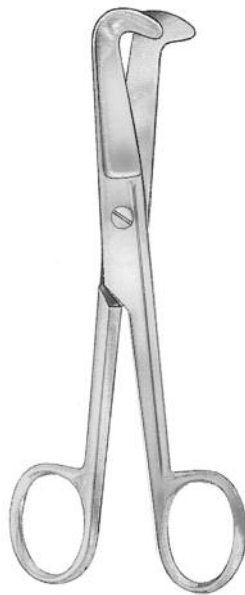

Schuhmacher
16,0 cm **TR-01-145-16**

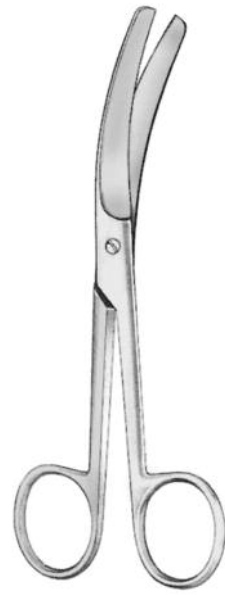

Busch
13,0 cm **TR-01-147-13**
16,0 cm **TR-01-147-16**

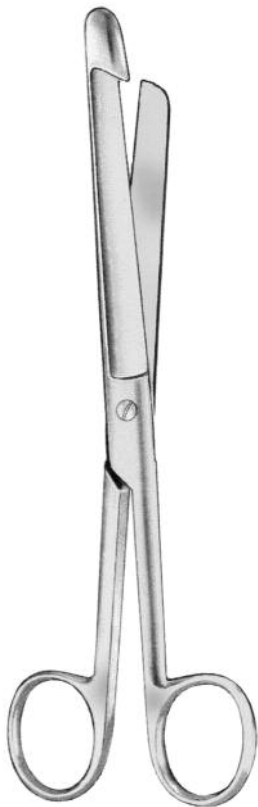

Bowel Scissors
21,0 cm **TR-01-150-21**

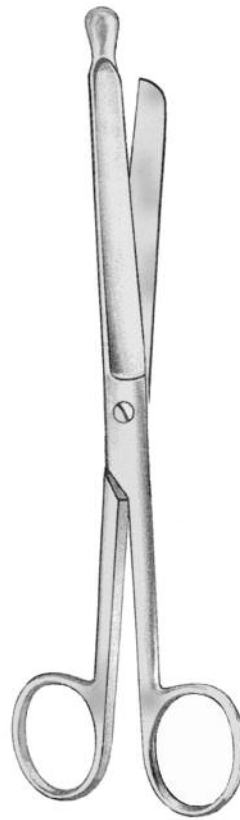

Bowel Scissors
21,0 cm **TR-01-151-21**



straight

Mayo

- 14,0 cm **TR-01-160-14**
- 15,0 cm **TR-01-160-15**
- 17,0 cm **TR-01-160-17**
- 19,0 cm **TR-01-160-19**
- 23,0 cm **TR-01-160-23**



curved

Mayo

- 14,0 cm **TR-01-161-14**
- 15,0 cm **TR-01-161-15**
- 17,0 cm **TR-01-161-17**
- 19,0 cm **TR-01-161-19**
- 23,0 cm **TR-01-161-23**



straight

Mayo-Harrington

- 22,0 cm **TR-01-166-22**



curved

Mayo-Harrington

- 22,0 cm **TR-01-167-22**

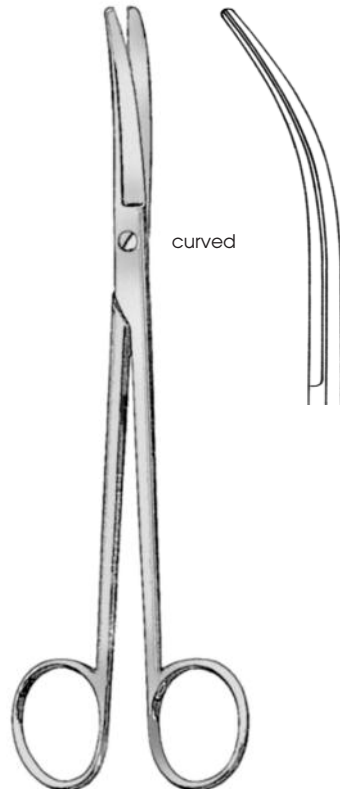

curved

Wertheim-Parametrium

- 22,0 cm **TR-01-169-22**

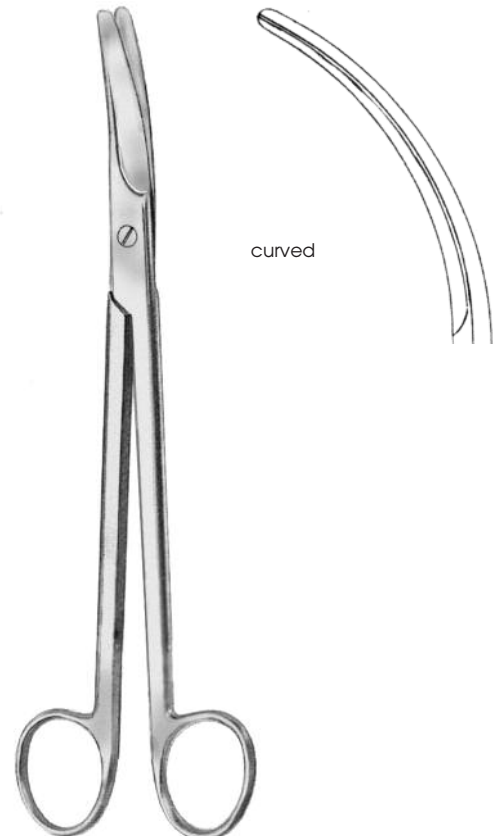

curved

Parametrium

- 23,0 cm **TR-01-169-23**

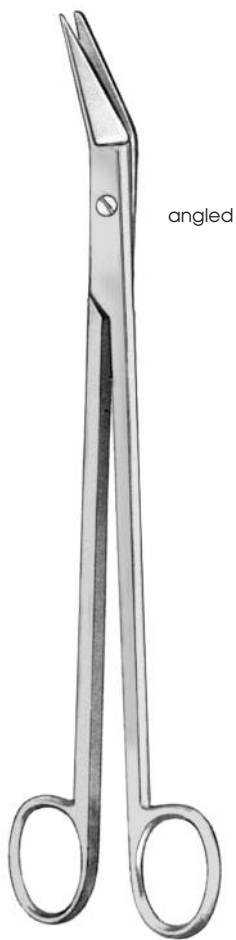

angled

Cortilage Scissors

24,5 cm **TR-01-175-24**

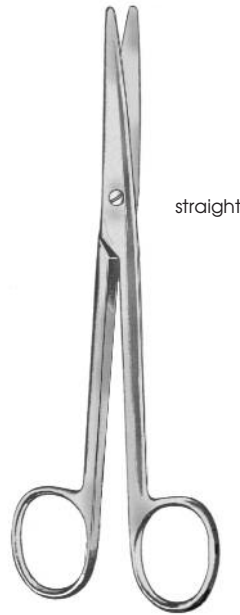

straight

Mayo-Style

15,0 cm **TR-01-170-15**
 17,0 cm **TR-01-170-17**
 19,0 cm **TR-01-170-19**
 21,0 cm **TR-01-170-21**
 23,0 cm **TR-01-170-23**



curved

Mayo-Style

15,0 cm **TR-01-171-15**
 17,0 cm **TR-01-171-17**
 19,0 cm **TR-01-171-19**
 21,0 cm **TR-01-171-21**
 23,0 cm **TR-01-171-23**

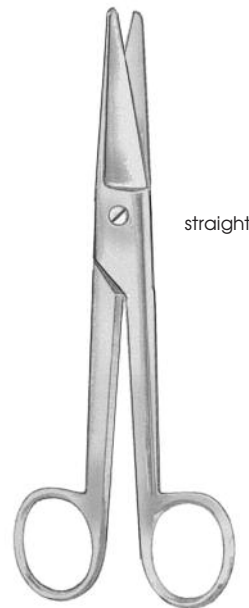

straight

Mayo-Noble

17,0 cm **TR-01-176-17**

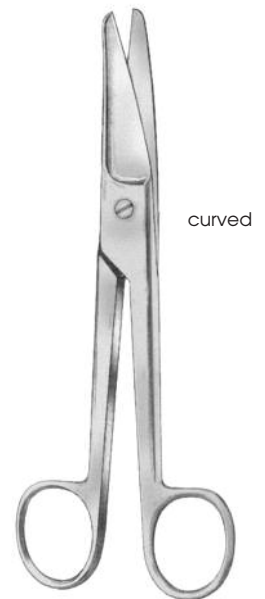

curved

Mayo-Noble

17,0 cm **TR-01-177-17**



straight

Metzenbaum
Fig.1

14,0 cm	TR-01-200-14
18,0 cm	TR-01-200-18
20,0 cm	TR-01-200-20
23,0 cm	TR-01-200-23
25,0 cm	TR-01-200-25
28,0 cm	TR-01-200-28
30,0 cm	TR-01-200-30



curved

Metzenbaum
Fig.1

14,0 cm	TR-01-201-14
18,0 cm	TR-01-201-18
20,0 cm	TR-01-201-20
23,0 cm	TR-01-201-23
25,0 cm	TR-01-201-25
28,0 cm	TR-01-201-28
30,0 cm	TR-01-201-30



straight

Metzenbaum
Fig.2

14,0 cm	TR-01-202-14
18,0 cm	TR-01-202-18
20,0 cm	TR-01-202-20
23,0 cm	TR-01-202-23
25,0 cm	TR-01-202-25
28,0 cm	TR-01-202-28
30,0 cm	TR-01-202-30



curved

Metzenbaum
Fig.2

14,0 cm	TR-01-203-14
18,0 cm	TR-01-203-18
20,0 cm	TR-01-203-20
23,0 cm	TR-01-203-23
25,0 cm	TR-01-203-25
28,0 cm	TR-01-203-28
30,0 cm	TR-01-203-30



straight

Metzenbaum
Fig.3

14,0 cm	TR-01-204-14
18,0 cm	TR-01-204-18
20,0 cm	TR-01-204-20
23,0 cm	TR-01-204-23
25,0 cm	TR-01-204-25
28,0 cm	TR-01-204-28
30,0 cm	TR-01-204-30



curved

Metzenbaum
Fig.3

14,0 cm	TR-01-205-14
18,0 cm	TR-01-205-18
20,0 cm	TR-01-205-20
23,0 cm	TR-01-205-23
25,0 cm	TR-01-205-25
28,0 cm	TR-01-205-28
30,0 cm	TR-01-205-30



straight

Metzenbaum-Fino
Fig.1

14,0 cm **TR-01-210-14**
18,0 cm **TR-01-210-18**
20,0 cm **TR-01-210-20**
23,0 cm **TR-01-210-23**



curved

Metzenbaum-Fino
Fig.1

14,0 cm **TR-01-211-14**
18,0 cm **TR-01-211-18**
20,0 cm **TR-01-211-20**
23,0 cm **TR-01-211-23**



straight

Metzenbaum-Fino
Fig.3

14,0 cm **TR-01-214-14**
18,0 cm **TR-01-214-18**
20,0 cm **TR-01-214-20**
23,0 cm **TR-01-214-23**



curved

Metzenbaum-Fino
Fig.3

14,0 cm **TR-01-215-14**
18,0 cm **TR-01-215-18**
20,0 cm **TR-01-215-20**
23,0 cm **TR-01-215-23**



S-shaped

Metzenbaum-Fino
Fig.1

14,0 cm **TR-01-221-14**
18,0 cm **TR-01-221-18**
20,0 cm **TR-01-221-20**
23,0 cm **TR-01-221-23**



straight

Metzenbaum
Fig.1

15,0 cm **TR-01-226-15**



curved

Metzenbaum
Fig.1

15,0 cm **TR-01-227-15**

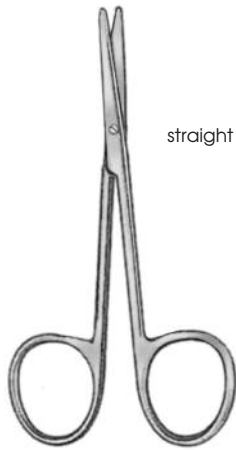

straight

Metzenbaum-Baby
11,0 cm TR-01-228-11

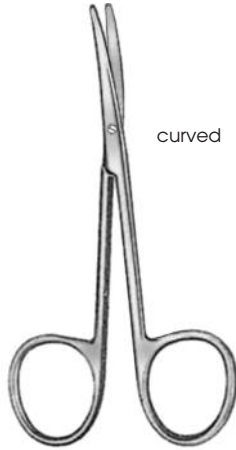

curved

Metzenbaum-Baby
11,0 cm TR-01-229-11

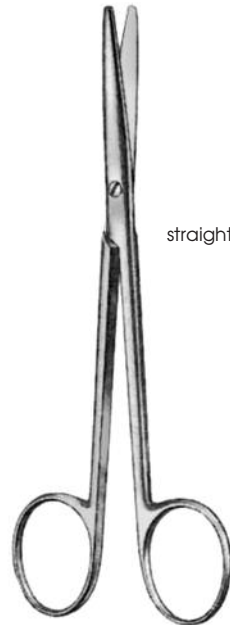

straight

Lexer
16,0 cm TR-01-230-16

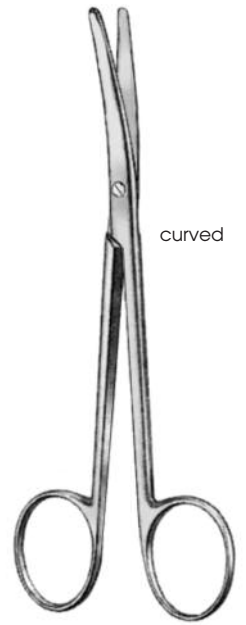

curved

Lexer
16,0 cm TR-01-231-16

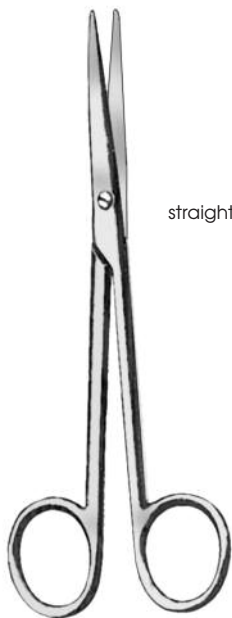

straight

Lexer-Fino
16,0 cm TR-01-232-16

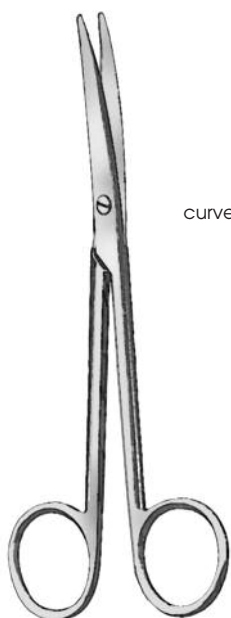

curved

Lexer-Fino
16,0 cm TR-01-233-16



straight

Lexer-Baby
10,0 cm TR-01-234-10



curved

Lexer-Baby
10,0 cm TR-01-235-10

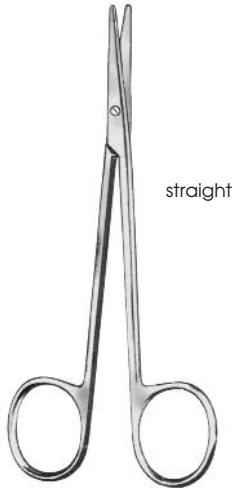

straight

Strabismus

11,0 cm TR-01-236-11

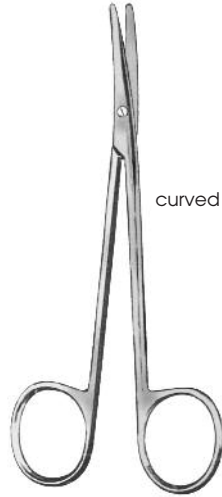

curved

Strabismus

11,0 cm TR-01-237-11

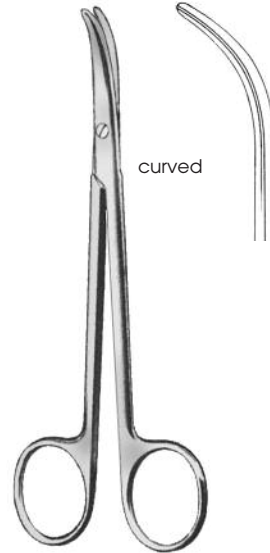

curved

Fomon

14,0 cm TR-01-239-14

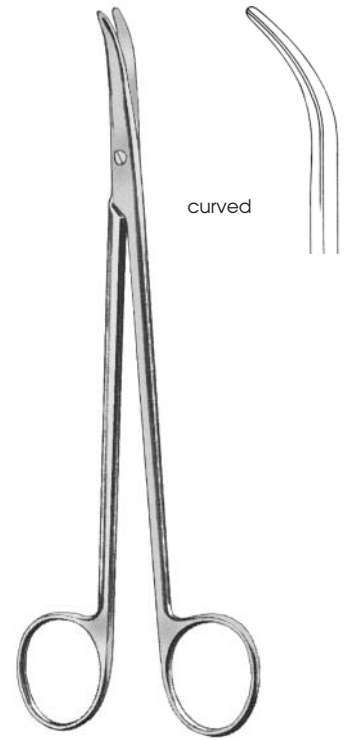

curved

Thorek

19,0 cm TR-01-241-19



straight, serrated

Gorney

12,5 cm TR-01-242-12
19,5 cm TR-01-242-19

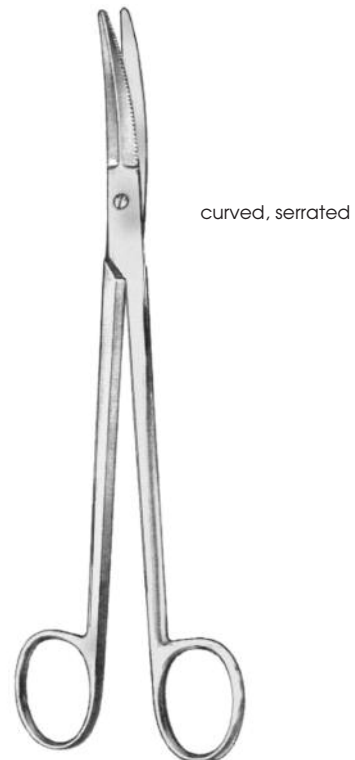

curved, serrated

Gorney

19,5 cm TR-01-243-19

Dissecting Scissors

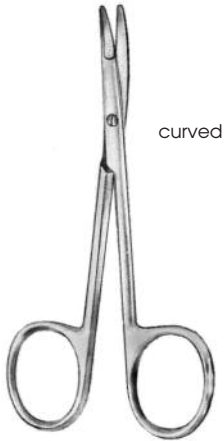

curved

Kilner (Ragnell)
12,0 cm **TR-01-245-12**
15,0 cm **TR-01-245-15**

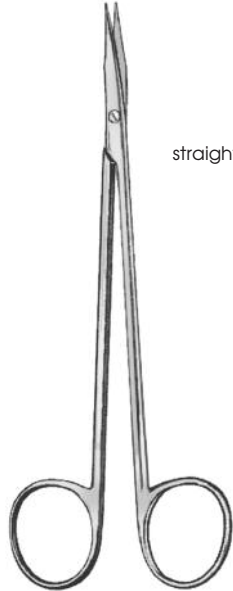

straight

Reynolds
15,0 cm **TR-01-248-15**
18,0 cm **TR-01-248-18**

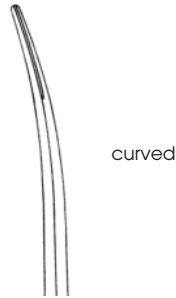

curved

Reynolds
15,0 cm **TR-01-249-15**
18,0 cm **TR-01-249-18**

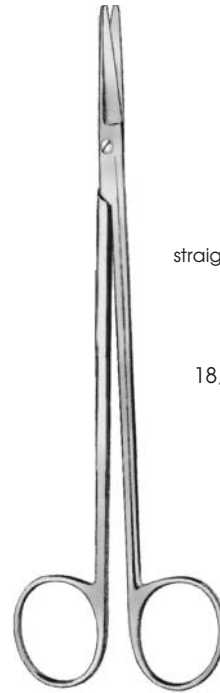

straight

Tönnis
18,0 cm **TR-01-250-18**



curved

Tönnis
18,0 cm **TR-01-251-18**



curved

Tönnis-Adson
17,5 cm **TR-01-253-17**



straight, serrated

Beuse
14,0 cm **TR-01-258-14**



curved, serrated

Beuse
14,0 cm **TR-01-259-14**

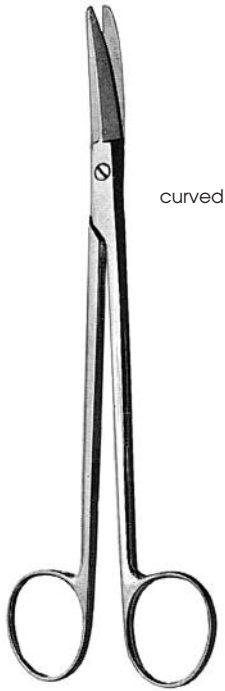

curved

Böttcher

18,0 cm TR-01-301-18



17,0 cm

Dean

17,0 cm TR-01-305-17



serrated

Dean

TR-01-307-17



curved

Good

19,0 cm TR-01-309-19



curved, serrated

Good-Schwekendieck

19,0 cm TR-01-311-19

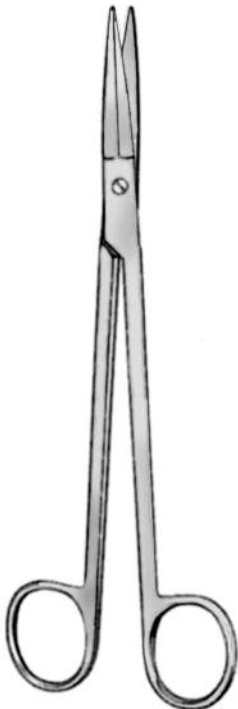

Mc Indoe

19,0 cm TR-01-312-19



angled

Fomon

13,0 cm TR-01-327-13

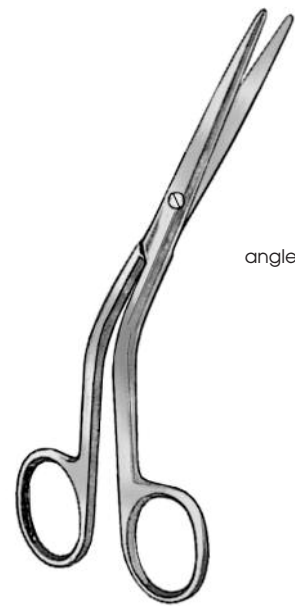

angled

Cottle

16,0 cm TR-01-331-16

Tonsil and Nasal Scissors



Heymann

18,0 cm **TR-01-333-18**
20,0 cm **TR-01-333-20**

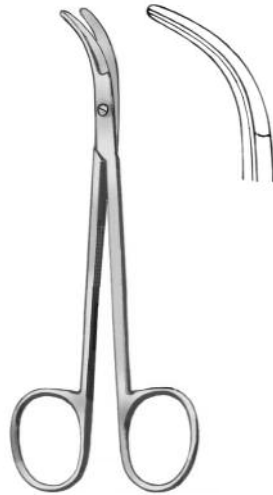

Fomon

11,5 cm **TR-01-343-11**

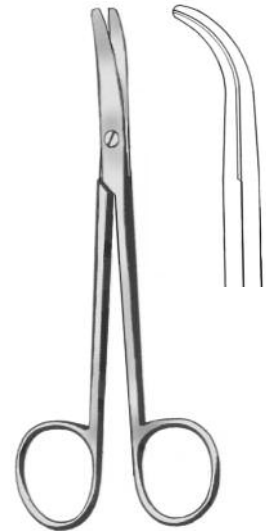

Fomon

13,5 cm **TR-01-343-13**



Landolt

11,5 cm **TR-01-345-11**



Landolt

11,5 cm **TR-01-345-12**



straight



curved

Kelly

16,0 cm **TR-01-401-16**
18,0 cm **TR-01-401-18**



straight



curved

Joseph

14,0 cm **TR-01-405-14**

Kelly

16,0 cm **TR-01-400-16**
18,0 cm **TR-01-400-18**

Joseph

14,0 cm **TR-01-404-14**



straight



curved

Sanvenero

14,0 cm **TR-01-409-14**

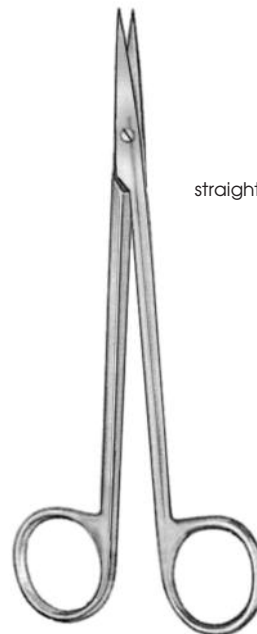

straight



curved

Nerve dissection scissors

15,0 cm **TR-01-411-15**

Sanvenero

14,0 cm **TR-01-408-14**

Nerve dissection scissors

15,0 cm **TR-01-410-15**

Delicate Surgical Scissors

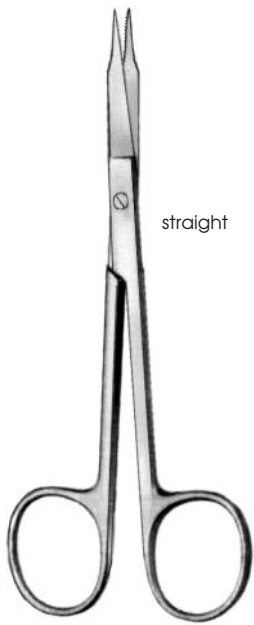

straight

Goldmann-Fox
13,0 cm **TR-01-416-13**

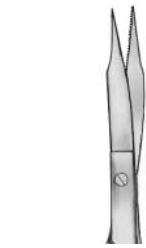

curved

Goldmann-Fox
13,0 cm **TR-01-417-13**

1 blade serrated



straight

Feine Schere
11,0 cm **TR-01-418-11**



curved

Feine Schere
11,0 cm **TR-01-419-11**



straight

Wagner
Fig 1
12,0 cm **TR-01-420-12**



curved

Fig. 1
12,0 cm **TR-01-421-12**



straight

Fig. 2
12,0 cm **TR-01-422-12**



curved

Fig. 2
12,0 cm **TR-01-423-12**



straight

Fig. 3
12,0 cm **TR-01-424-12**



curved

Fig. 3
12,0 cm **TR-01-425-12**



straight

Wagner, flach
Fig 3

12,0 cm **TR-01-426-12**

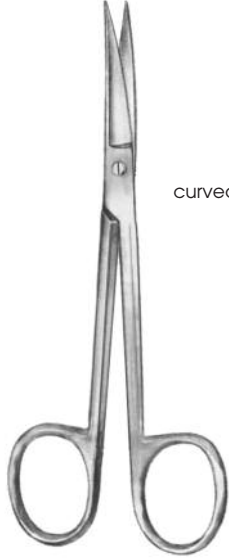

curved

Wagner, flach
Fig 3

12,0 cm **TR-01-427-12**



straight

Delicate Scissors

11,0 cm **TR-01-428-11**



curved

Delicate Scissors

11,0 cm **TR-01-429-11**



curved

Littler

11,0 cm **TR-01-431-11**
14,0 cm **TR-01-431-14**



straight

Stevens
Fig. 1

10,0 cm **TR-01-432-10**
11,5 cm **TR-01-432-11**



curved

Stevens
Fig. 1

10,0 cm **TR-01-433-10**
11,5 cm **TR-01-433-11**



straight

Stevens
Fig. 3

10,0 cm **TR-01-434-10**
11,5 cm **TR-01-434-11**

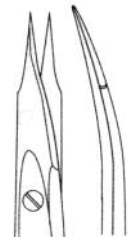

curved

Stevens
Fig. 3

10,0 cm **TR-01-435-10**
11,5 cm **TR-01-435-11**

Delicate Surgical Scissors



straight

Iris

- 9,0 cm **TR-01-440-09**
- 10,0 cm **TR-01-440-10**
- 11,0 cm **TR-01-440-11**
- 12,0 cm **TR-01-440-12**

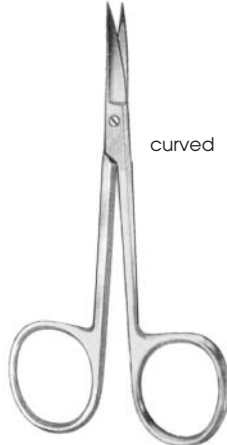

curved

Iris

- 9,0 cm **TR-01-441-09**
- 10,0 cm **TR-01-441-10**
- 11,0 cm **TR-01-441-11**
- 12,0 cm **TR-01-441-12**



straight

Iris Fino

- 10,0 cm **TR-01-442-10**
- 11,5 cm **TR-01-442-11**



curved

Iris Fino

- 10,0 cm **TR-01-443-10**
- 11,5 cm **TR-01-443-11**

- 9,5 cm **TR-01-400-09**
- 10,5 cm **TR-01-400-10**
- 11,5 cm **TR-01-400-11**

- 9,5 cm **TR-01-401-09**
- 10,5 cm **TR-01-401-10**
- 11,5 cm **TR-01-401-11**



straight

Bonn

- 8,0 cm **TR-01-446-08**
- 9,0 cm **TR-01-446-09**

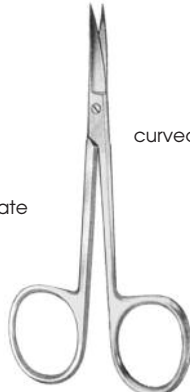

curved

Bonn

- 8,0 cm **TR-01-447-08**
- 9,0 cm **TR-01-447-09**

extra delicate



angled

Graefe

- 10,0 cm **TR-01-449-10**

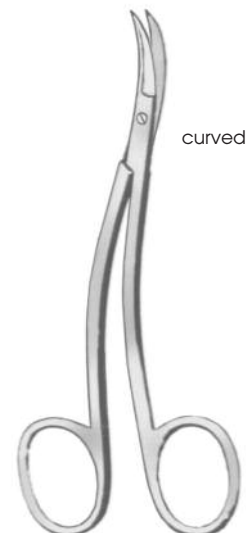

curved

La Grange

- 11,0 cm **TR-01-453-11**



Satinsky
24,0 cm TR-01-501-24



Klinkenbergh-Loth
23,0 cm TR-01-503-23



Strully
22,0 cm TR-01-505-22



Church
17,0 cm TR-01-506-17

straight



curved

Church

17,0 cm TR-01-507-17



Dandy
17,0 cm TR-01-511-17



Classon
17,0 cm TR-01-513-17

Scissors for Vascular and Neuro Surgery



Potts-Smith
19,0 cm TR-01-515-19

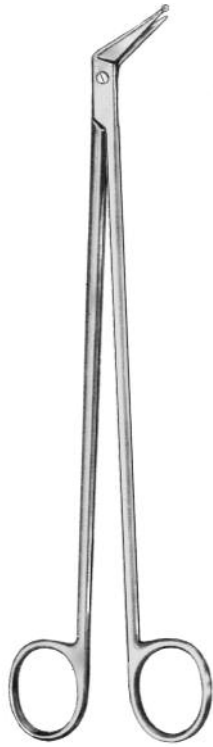

Mills
19,0 cm TR-01-517-19



angled, serrated

Locklin
16,0 cm TR-01-519-16

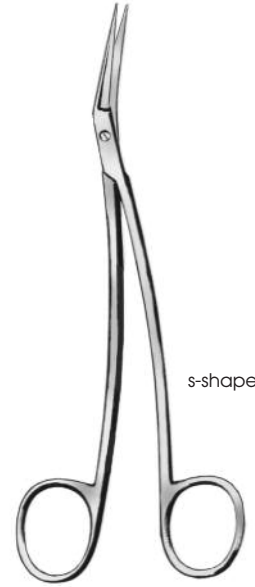

s-shaped

Locklin
16,0 cm TR-01-521-16



Schmieden-Taylor
17,0 cm TR-01-523-17



Favaloro
15,0 cm TR-01-529-15



Coronar
with probe point
11,0 cm TR-01-530-11



Coronar
with probe point
11,0 cm TR-01-532-14

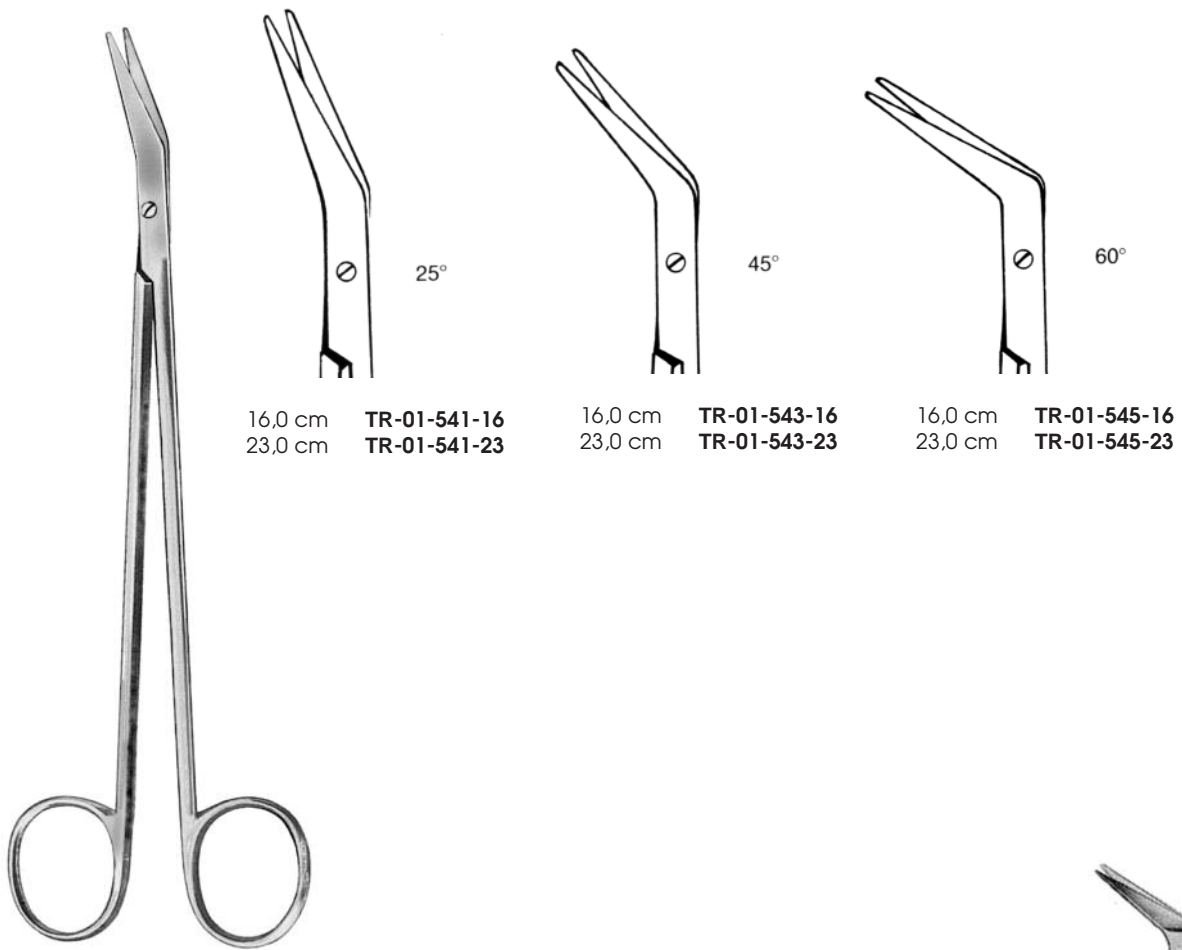

De Bakey

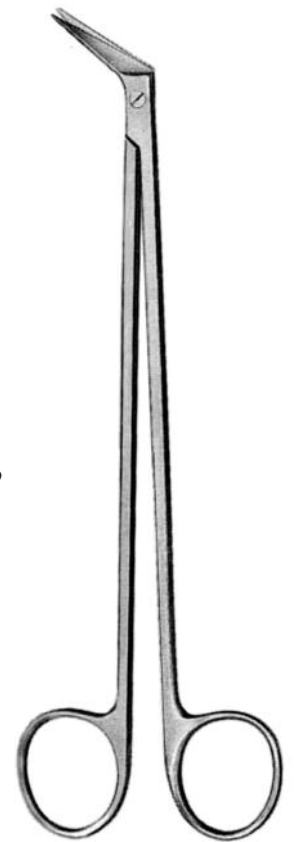
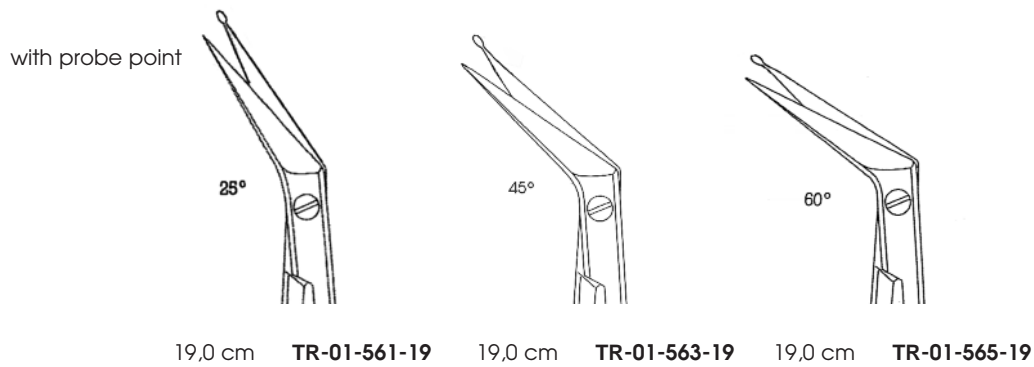
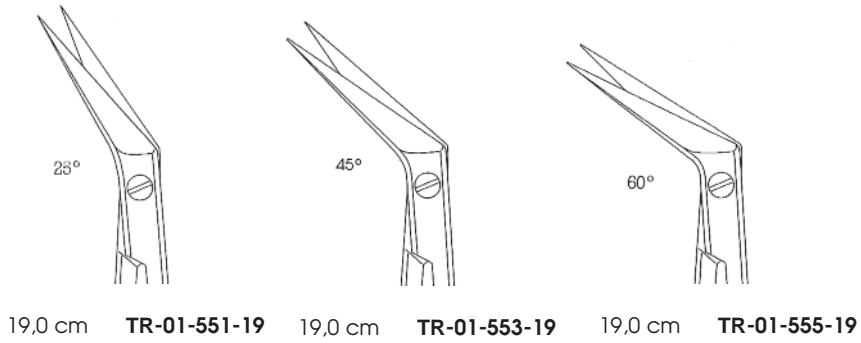

Potts-Smith

Scissors for Vascular and Neuro Surgery

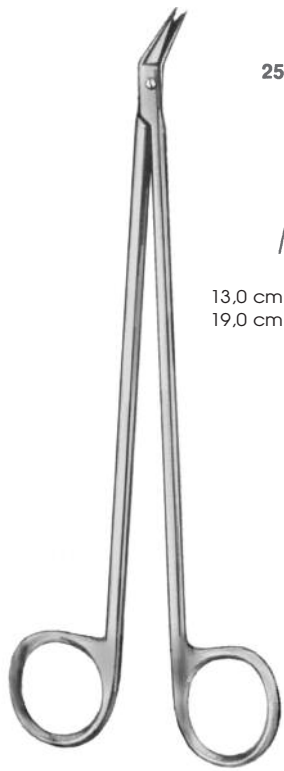

Hegemann-Diethrich

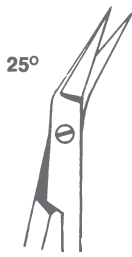

13,0 cm **TR-01-571-13**
19,0 cm **TR-01-571-19**



13,0 cm **TR-01-573-13**
19,0 cm **TR-01-573-19**



13,0 cm **TR-01-575-13**
19,0 cm **TR-01-575-19**



13,0 cm **TR-01-577-13**
19,0 cm **TR-01-577-19**



19,0 cm **TR-01-579-19**

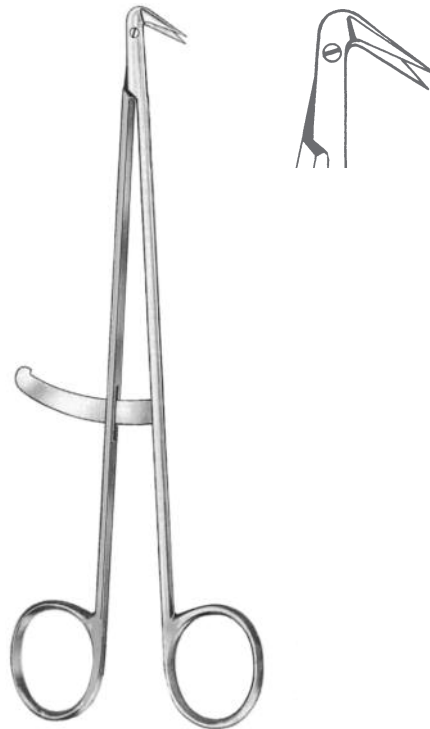

Hegemann-Diethrich
19,0 cm **TR-01-589-19**



Vannas



straight

8,5 cm **TR-01-591-07**



curved

8,5 cm **TR-01-591-08**



angled

8,5 cm **TR-01-591-09**



angled

Castroviejo
9,5 cm **TR-01-593-09**



curved

Castroviejo
11,0 cm **TR-01-593-10**



straight

10,5 cm **TR-01-594-10**



curved

10,5 cm **TR-01-594-11**



Wecker

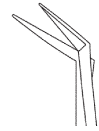

11,0 cm **TR-01-595-10**

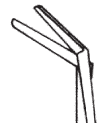

11,0 cm **TR-01-595-11**

Micro Scissors ,bayonet-shaped

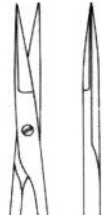

straight



curved

15,5 cm **TR-01-600-15**

15,5 cm **TR-01-601-15**

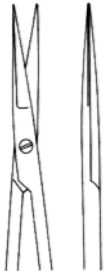

straight



curved



curved downward



angled

19,0 cm **TR-01-602-19**

19,0 cm **TR-01-603-19**





19,0 cm **TR-01-604-19**

19,0 cm **TR-01-605-19**



Micro Scissors, bayonet-shaped



	straight		curved		straight		curved
23,0 cm	TR-01-606-23	23,0 cm	TR-01-607-23	15,0 cm	TR-01-608-15	15,0 cm	TR-01-609-15

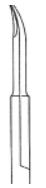

	straight		curved
19,0 cm	TR-01-610-19	19,0 cm	TR-01-611-19
23,0 cm	TR-01-612-23	23,0 cm	TR-01-613-23

Micro Scissors

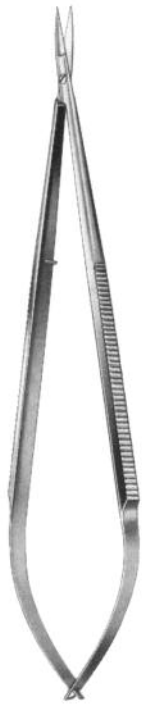

straight

18,5 cm **TR-01-614-18**



curved

18,5 cm **TR-01-615-18**



angled

18,5 cm **TR-01-616-18**



25°

18,0 cm **TR-01-617-18**



45°

18,0 cm **TR-01-618-18**



60°

18,0 cm **TR-01-619-18**

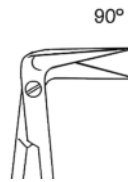

90°

18,0 cm **TR-01-620-18**

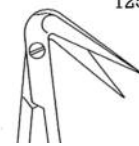

125°

18,0 cm **TR-01-621-18**



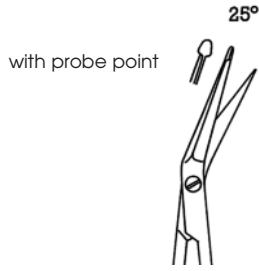

18,0 cm **TR-01-622-18**



18,0 cm **TR-01-623-18**



18,0 cm **TR-01-624-18**



18,0 cm **TR-01-625-18**



18,0 cm **TR-01-626-18**



15,0 cm **TR-01-627-15**



14,0 cm **TR-01-628-14**



Reill



15,5 cm **TR-01-629-15**

1 blade serrated

Micro Scissors



Westcott



straight

11,0 cm **TR-01-630-11**



curved

11,0 cm **TR-01-631-11**

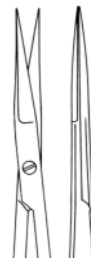

straight

12,0 cm **TR-01-632-12**



curved

11,0 cm **TR-01-633-11**



straight

9,0 cm **TR-01-634-09**



angled

9,0 cm **TR-01-635-09**

Micro Scissors, bayonet-shaped



Yasargil



24,5 cm
TR-01-651-24



22,5 cm
TR-01-652-22



22,5 cm
TR-01-653-22



serrated
22,5 cm
TR-01-654-22



22,5 cm
TR-01-655-22



Vannas



22,5 cm **TR-01-656-22**



22,5 cm **TR-01-657-22**



23,0 cm **TR-01-684-23**



14,5 cm **TR-01-810-14**



14,5 cm **TR-01-811-14**



Dissecting Scissors
14,5 cm **TR-01-843-14**

Ligature Scissors



Spencer

9,0 cm TR-01-700-09
10,0 cm TR-01-700-10
12,0 cm TR-01-700-12



Spencer

11,0 cm TR-01-701-11

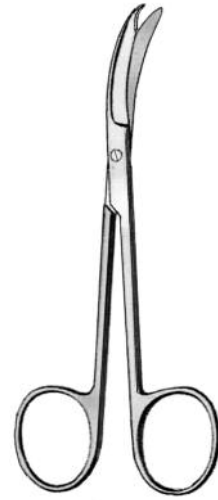

Northbent

13,0 cm TR-01-705-13

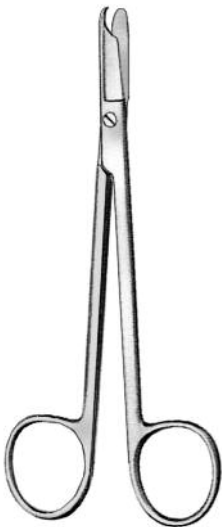

Littauer

13,0 cm TR-01-706-13
14,0 cm TR-01-706-14
16,0 cm TR-01-706-16



Buck

14,0 cm TR-01-708-14
18,0 cm TR-01-708-18



Eiselberg

12,0 cm TR-01-710-12

Wire Cutting and Ligature Scissors



Schoemaker-Loth
12,0 cm TR-01-712-12

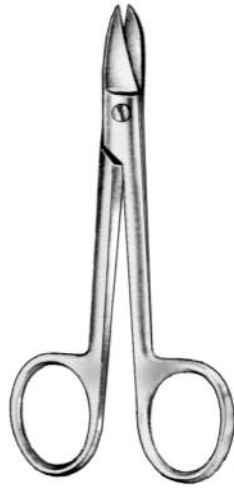

Beebe

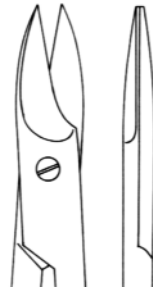

10,0 cm TR-01-714-10
12,0 cm TR-01-714-12



10,0 cm TR-01-715-10
12,0 cm TR-01-715-12

serrated

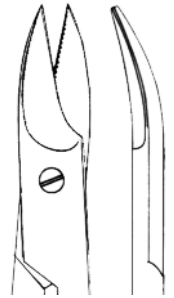

12,0 cm TR-01-719-12

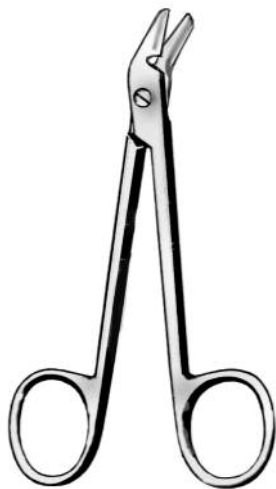

Universal
12,0 cm TR-01-721-12

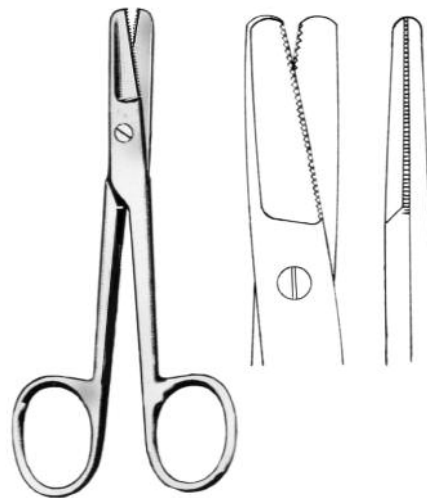

Harvey
12,0 cm TR-01-722-12



02

TC-Scissors

Scissors with TC Cutting Edges

also known as WOLFRAM or TUNGSTEN CARBIDE cutting edges, is a term that is recognized world-wide. This is one of the hardest metal alloy compositions and it approaches "diamond hardness".

TC-Scissors are the surgeon's tools and must therefore be durable and remain consistent in quality

Surgical TC-Scissors are particularly distinguished due to their:

- excellent cutting action
- long working life
- 5 years guarantee
- welded Tungsten Carbide Inserts
- goldplated rings
- solid and harmonious function

Wave Cutting Edges

All scissors are available with wavy cutting edges ("BS-Wellenschliff"). The scissors have a special grind on the lower cutting edges. This prevents tissue slipping out.



blunt/blunt



Standard, Fig. 1
14,5 cm **TR-02-000-14**

sharp/blunt



Standard, Fig. 2
14,5 cm **TR-02-002-14**

sharp/sharp



Standard, Fig. 3
14,5 cm **TR-02-004-14**

blunt/blunt

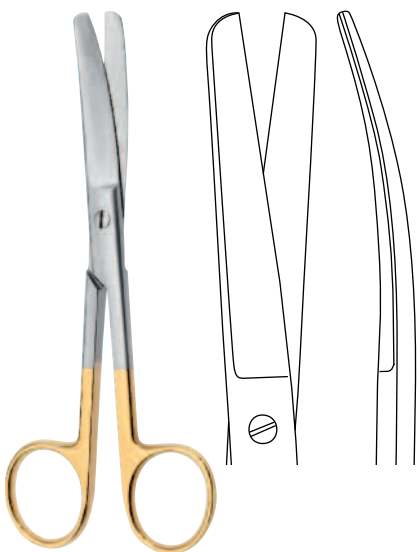

Standard, Fig. 1
14,5 cm **TR-02-001-14**

sharp/blunt

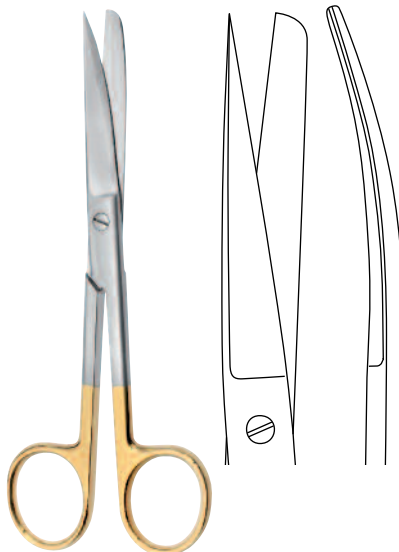

Standard, Fig. 2
14,5 cm **TR-02-003-14**

sharp/sharp



Standard, Fig. 3
14,5 cm **TR-02-005-14**

Operating and Gynecological Scissors

blunt/blunt

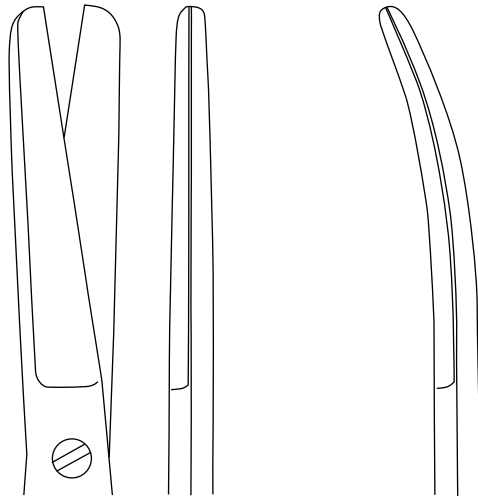

Fig. 1

20,0 cm
23,0 cm

TR-02-120-20
TR-02-120-23

TR-02-121-20
TR-02-121-23



Sims

sharp/blunt

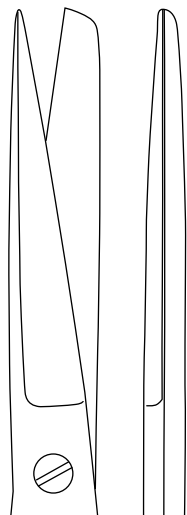

Fig. 2

20,0 cm
23,0 cm

TR-02-122-20
TR-02-122-23



TR-02-123-20
TR-02-123-23

sharp/sharp



Fig. 3

20,0 cm
23,0 cm

TR-02-124-20
TR-02-124-23



TR-02-125-20
TR-02-125-23

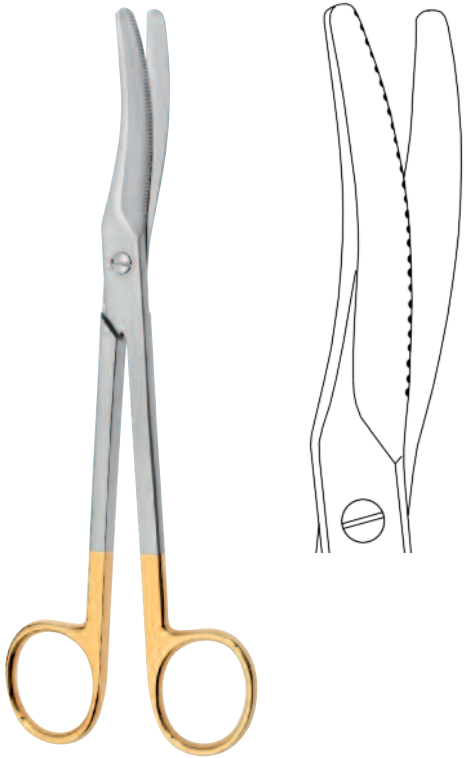

Waldmann
20,0 cm **TR-02-141-20**



Mayo

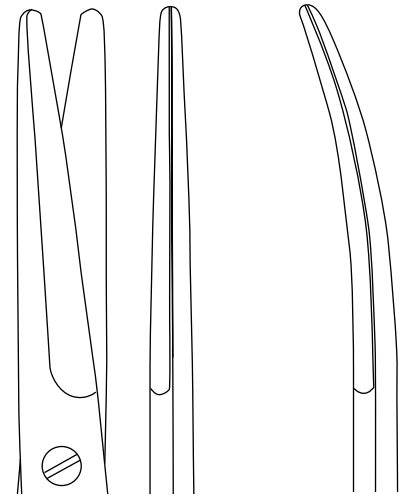

14,0 cm	TR-02-160-14	TR-02-161-14
17,0 cm	TR-02-160-17	TR-02-161-17
23,0 cm	TR-02-160-23	TR-02-161-23

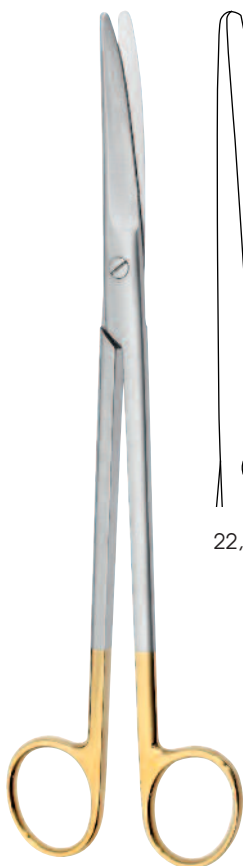

Mayo-Harrington

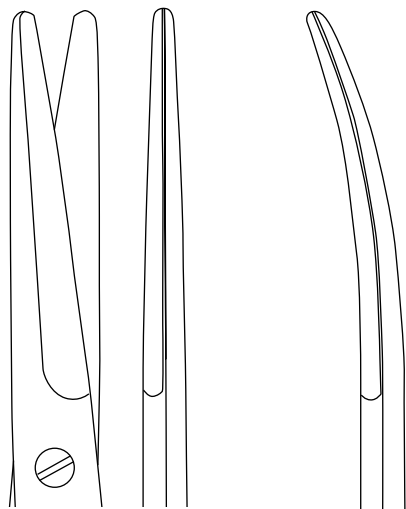

22,0 cm	TR-02-166-22	TR-02-167-22
---------	---------------------	---------------------



Parametrium



23,0 cm **TR-02-169-23**

Gynecological and Dissecting Scissors



Mayo-Style

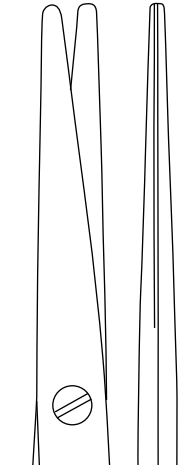

15,0 cm **TR-02-170-15**
17,0 cm **TR-02-170-17**
21,0 cm **TR-02-170-21**



TR-02-171-15
TR-02-171-17
TR-02-171-21

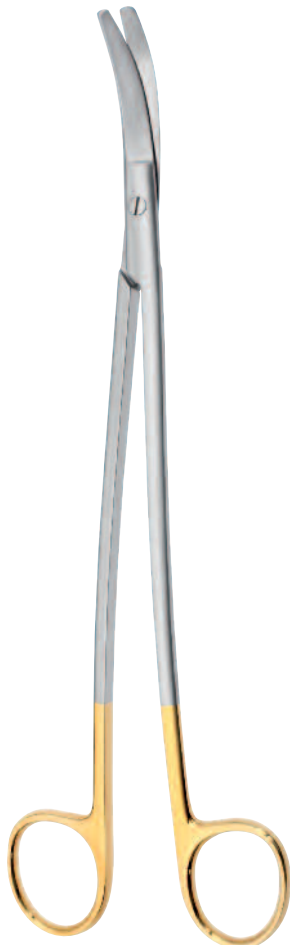

Hysterektomie



25,5 cm **TR-02-173-25**



25,0 cm **TR-02-175-25**



Metzenbaum, Fig. 1



11,0 cm **TR-02-200-11**
 14,0 cm **TR-02-200-14**
 18,0 cm **TR-02-200-18**
 20,0 cm **TR-02-200-20**
 23,0 cm **TR-02-200-23**
 25,0 cm **TR-02-200-25**
 28,0 cm **TR-02-200-28**
 30,0 cm **TR-02-200-30**



TR-02-201-11
TR-02-201-14
TR-02-201-18
TR-02-201-20
TR-02-201-23
TR-02-201-25
TR-02-201-28
TR-02-201-30



Metzenbaum-Fino, Fig. 1



14,0 cm **TR-02-210-14**
 18,0 cm **TR-02-210-18**
 20,0 cm **TR-02-210-20**
 23,0 cm **TR-02-210-23**
 25,0 cm **TR-02-210-25**
 28,0 cm **TR-02-210-28**



TR-02-211-14
TR-02-211-18
TR-02-211-20
TR-02-211-23
TR-02-211-25
TR-02-211-28

Dissecting Scissors

sharp/sharp

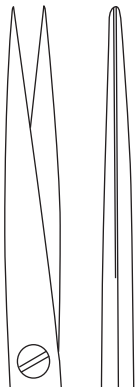

14,0 cm	TR-02-214-14
18,0 cm	TR-02-214-18
20,0 cm	TR-02-214-20
23,0 cm	TR-02-214-23

TR-02-215-14
TR-02-215-18
TR-02-215-20
TR-02-215-23

Metzenbaum-Fino, Fig. 3



S-shaped

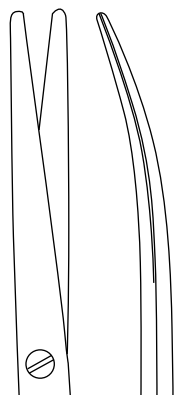

18,0 cm	TR-02-221-18
20,0 cm	TR-02-221-20
23,0 cm	TR-02-221-23

Metzenbaum, Fig. 1

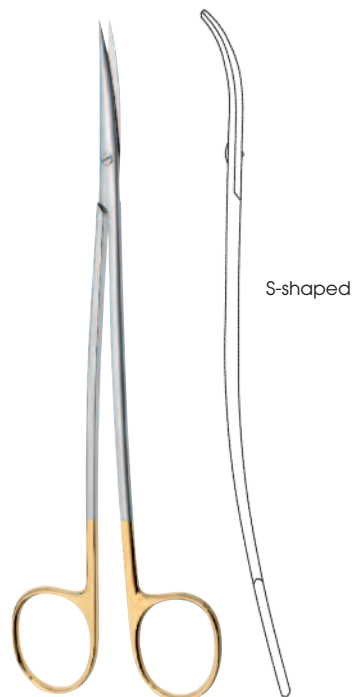

S-shaped

sharp/sharp



18,0 cm	TR-02-225-18
20,0 cm	TR-02-225-20
23,0 cm	TR-02-225-23

Metzenbaum, Fig. 3

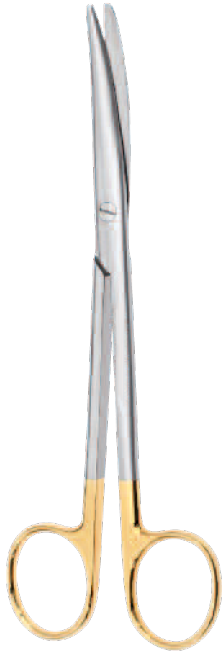

Mayo-Lexer



16,0 cm
21,0 cm



TR-02-230-16
TR-02-230-21



TR-02-231-16
TR-02-231-21



Lexer-Fino



16,0 cm



TR-02-232-16



TR-02-233-16

Dissecting Scissors



Metzenbaum-Thorek

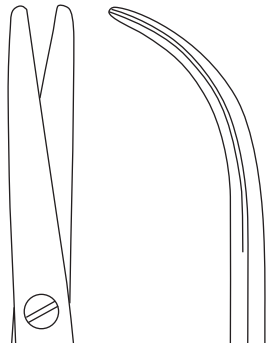

18,0 cm **TR-02-241-18**
 20,0 cm **TR-02-241-20**
 23,0 cm **TR-02-241-23**
 28,0 cm **TR-02-241-28**



Kilner-Fino



12,0 cm **TR-02-245-12**
 15,0 cm **TR-02-245-15**

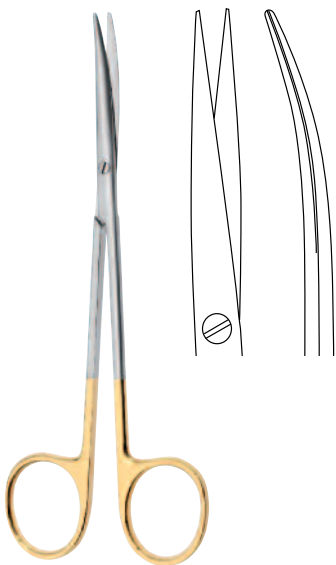

Metzenbaum-Lahey

14,0 cm **TR-02-253-14**

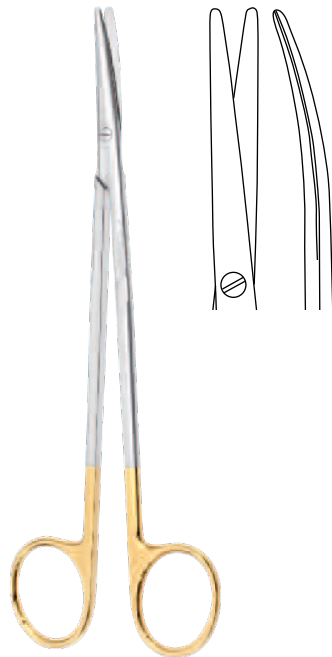

Toennis-Adson

17,0 cm **TR-02-253-17**

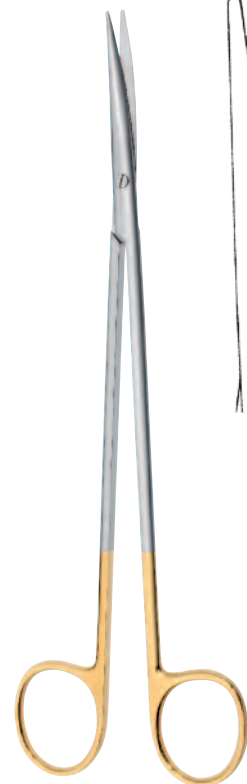
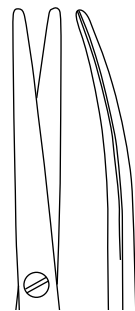

Metzenbaum-Extrem-Fino

20,0 cm **TR-02-253-20**
 23,0 cm **TR-02-253-23**

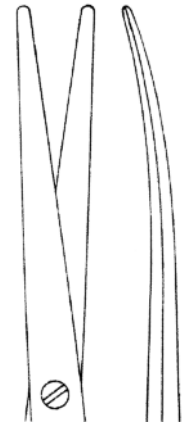

Tonsil Nasal Scissors

sharp/sharp

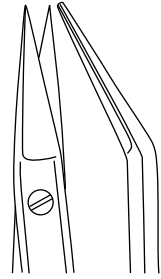

One blade serrated

Dean
17,0 cm TR-02-305-17

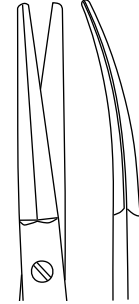

Fomon
13,0 cm TR-02-319-13

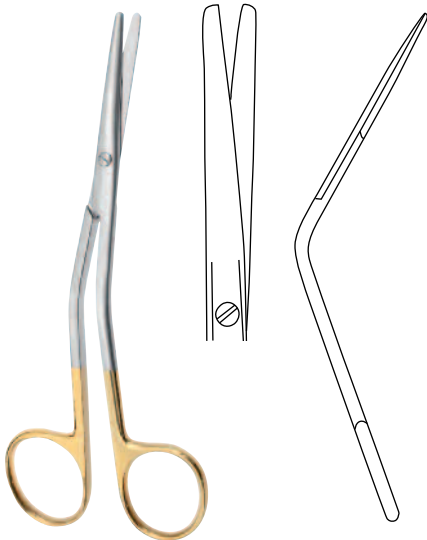

Fomon
13,0 cm TR-02-329-13

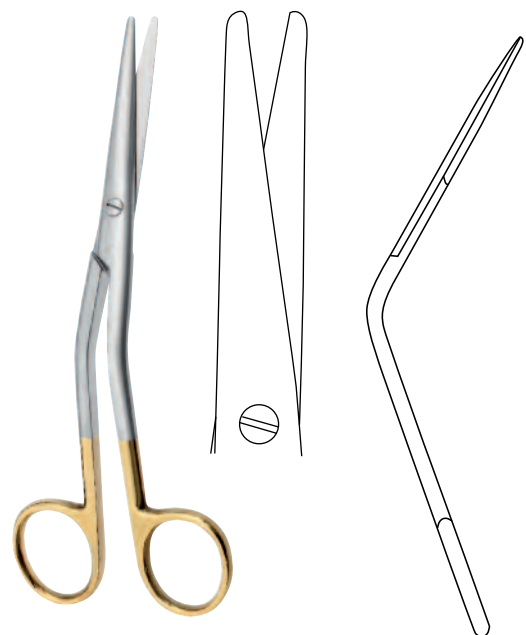

Cottle
16,0 cm TR-02-331-16

Fine Operating Scissors

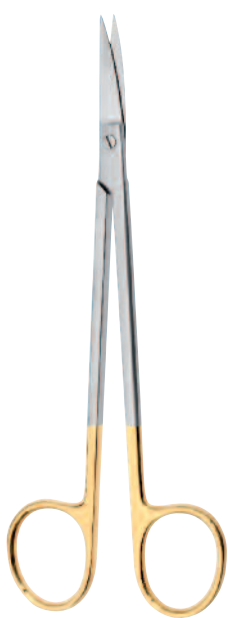

Kelly

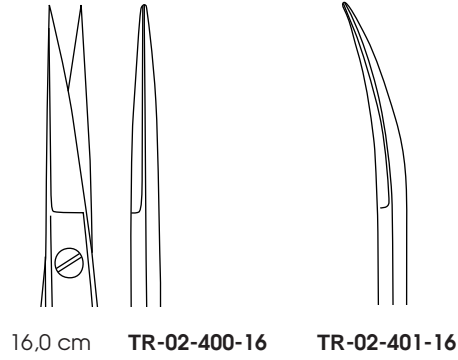

Joseph

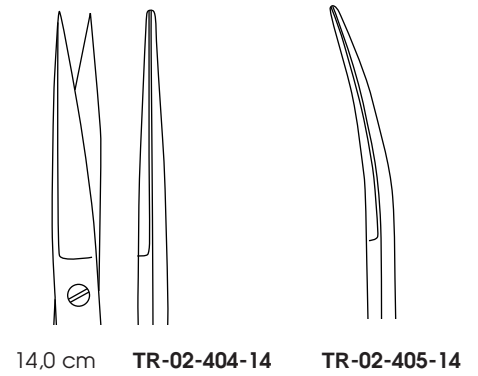

Goldman-Fox

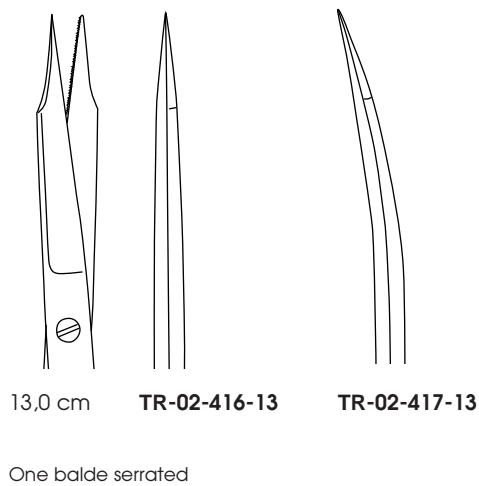

Wagner

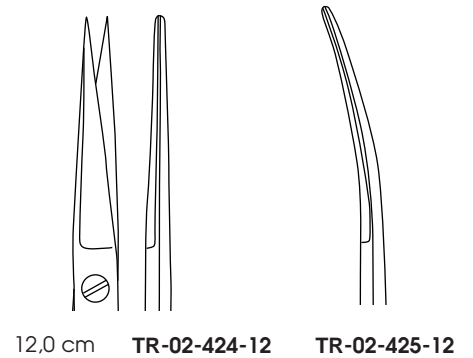



Feine Schere



11,0 cm



TR-02-428-11



TR-02-429-11



Iris



11,5 cm



TR-02-436-11



TR-02-437-11



Iris

11,5 cm **TR-02-438-11**

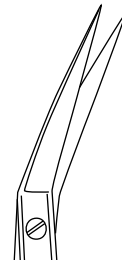

Scissors for Cardiovascular Surgery

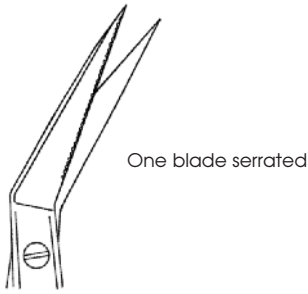
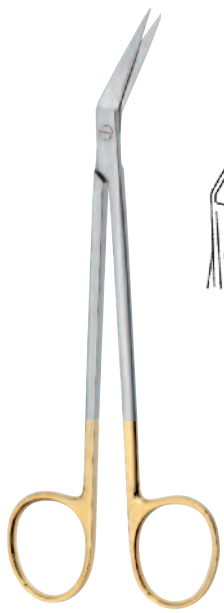

Locklin

16,0 cm **TR-02-519-16**



S-shaped

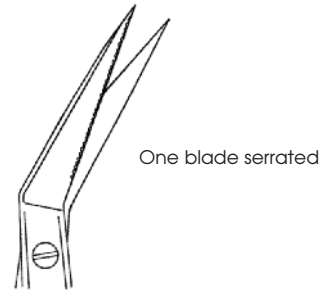

Locklin

16,0 cm **TR-02-521-16**



16,5 cm	TR-02-541-16	TR-02-543-16	TR-02-545-16
23,0 cm	TR-02-541-23	TR-02-543-23	TR-02-545-23
28,0 cm	TR-02-541-28	TR-02-543-28	TR-02-545-28

De Bakey

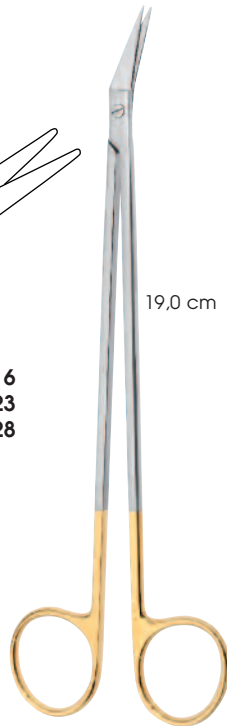

19,0 cm	TR-02-551-19	TR-02-553-19	TR-02-555-19
---------	---------------------	---------------------	---------------------

Potts-Smith



One blade serrated

Universal

12,0 cm **TR-02-721-12**

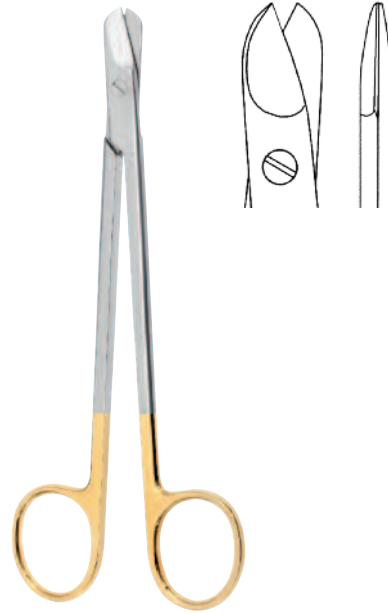

Smith

16,0 cm **TR-02-724-16**

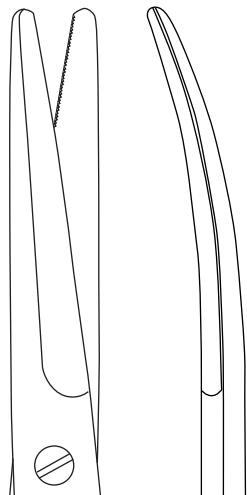
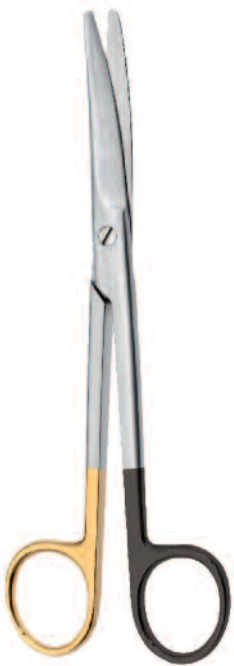

14,0 cm **TR-02-731-14**
17,0 cm **TR-02-731-17**
23,0 cm **TR-02-731-23**

Mayo

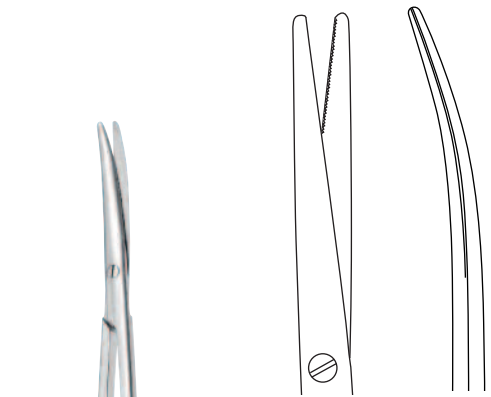

18,0 cm **TR-02-733-18 W**
23,0 cm **TR-02-733-23 W**
26,0 cm **TR-02-733-26 W**

with wave cutting edges

Metzenbaum

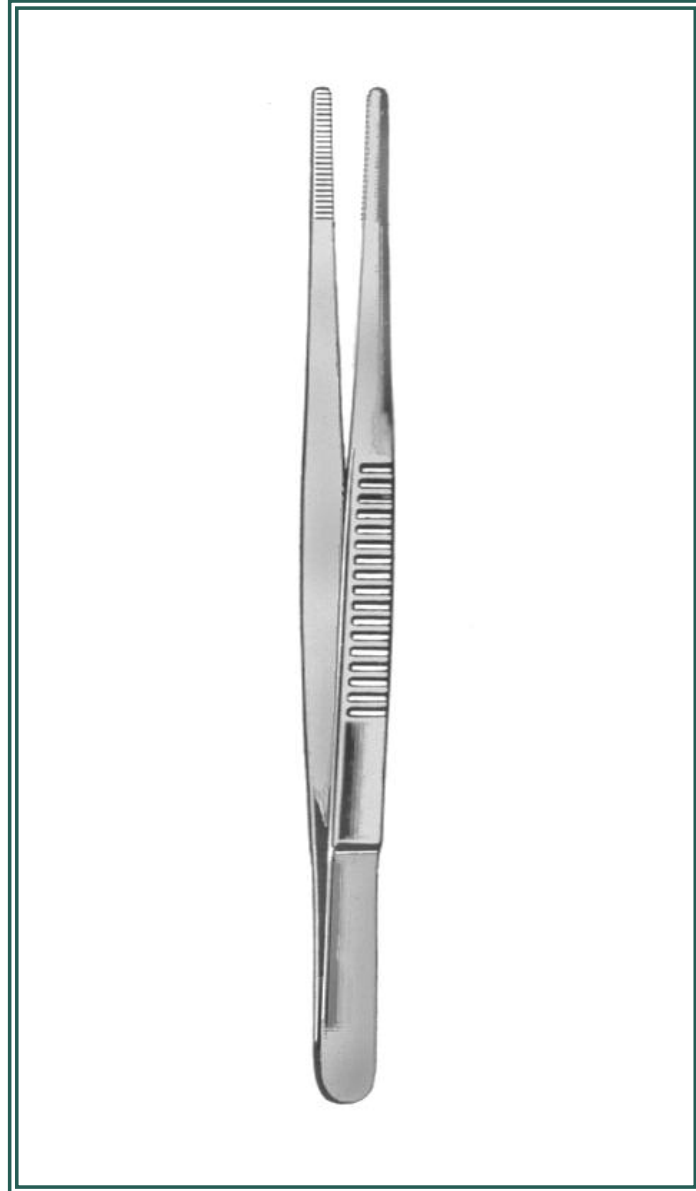

03

Forceps

Dressing Forceps



Standard

- 10,0 cm **TR-03-000-10**
- 11,0 cm **TR-03-000-11**
- 13,0 cm **TR-03-000-13**
- 14,0 cm **TR-03-000-14**
- 16,0 cm **TR-03-000-16**
- 18,0 cm **TR-03-000-18**
- 20,0 cm **TR-03-000-20**
- 25,0 cm **TR-03-000-25**
- 30,0 cm **TR-03-000-30**



Standard

- 10,0 cm **TR-03-001-10**
- 11,0 cm **TR-03-001-11**
- 13,0 cm **TR-03-001-13**
- 14,0 cm **TR-03-001-14**
- 16,0 cm **TR-03-001-16**
- 18,0 cm **TR-03-001-18**
- 20,0 cm **TR-03-001-20**
- 25,0 cm **TR-03-001-25**
- 30,0 cm **TR-03-001-30**



narrow

Standard

- 11,0 cm **TR-03-002-11**
- 13,0 cm **TR-03-002-13**
- 14,0 cm **TR-03-002-14**
- 16,0 cm **TR-03-002-16**
- 18,0 cm **TR-03-002-18**
- 20,0 cm **TR-03-002-20**
- 25,0 cm **TR-03-002-25**
- 30,0 cm **TR-03-002-30**



narrow

Standard

- 11,0 cm **TR-03-003-11**
- 13,0 cm **TR-03-003-13**
- 14,0 cm **TR-03-003-14**
- 16,0 cm **TR-03-003-16**
- 18,0 cm **TR-03-003-18**
- 20,0 cm **TR-03-003-20**
- 25,0 cm **TR-03-003-25**
- 30,0 cm **TR-03-003-30**



delicate

Standard

- 10,0 cm **TR-03-004-10**
- 11,5 cm **TR-03-004-11**
- 13,0 cm **TR-03-004-13**
- 14,0 cm **TR-03-004-14**
- 16,0 cm **TR-03-004-16**
- 18,0 cm **TR-03-004-18**
- 20,0 cm **TR-03-004-20**



Sweden pattern

- 13,0 cm **TR-03-006-13**
- 15,0 cm **TR-03-006-15**
- 17,0 cm **TR-03-006-17**
- 20,0 cm **TR-03-006-20**



Microscopic forceps

- 9,0 cm **TR-03-008-09**
- 10,5 cm **TR-03-008-10**
- 11,5 cm **TR-03-008-11**
- 13,0 cm **TR-03-008-13**
- 14,5 cm **TR-03-008-14**



Microscopic forceps

- 9,0 cm **TR-03-009-09**
- 10,5 cm **TR-03-009-10**
- 11,5 cm **TR-03-009-11**
- 13,0 cm **TR-03-009-13**
- 14,5 cm **TR-03-009-14**



10,0 cm



TR-03-010-10



10,0 cm

TR-03-011-10



narrow

Microscopic Forceps

Modell USA

- 12,0 cm **TR-03-020-12**
- 13,0 cm **TR-03-020-13**
- 14,0 cm **TR-03-020-14**
- 15,0 cm **TR-03-020-15**
- 18,0 cm **TR-03-020-18**
- 21,0 cm **TR-03-020-21**
- 25,0 cm **TR-03-020-25**
- 31,0 cm **TR-03-020-31**

Modell USA

- 12,0 cm **TR-03-022-12**
- 13,0 cm **TR-03-022-13**
- 14,0 cm **TR-03-022-14**
- 15,0 cm **TR-03-022-15**



10,0 cm

TR-03-034-10



10,0 cm

TR-03-035-10



10,0 cm

TR-03-035-11

Stille

- 11,0 cm **TR-03-030-11**
- 13,0 cm **TR-03-030-13**
- 15,0 cm **TR-03-030-15**
- 17,0 cm **TR-03-030-17**
- 20,0 cm **TR-03-030-20**

Delicate Dissecting Forceps

Dressing Forceps



Adson

12,0 cm **TR-03-040-12**



Adson

12,0 cm **TR-03-042-12**
15,0 cm **TR-03-042-15**



narrow



Adson

12,0 cm **TR-03-044-12**



delicate



Adson

12,0 cm **TR-03-046-12**



micro



Adson

12,0 cm **TR-03-047-12**



delicate



Mc Indoe

15,0 cm **TR-03-050-15**



Gillies

15,0 cm **TR-03-052-15**



Semken

12,0 cm **TR-03-054-12**
15,0 cm **TR-03-054-15**



Semken

12,0 cm **TR-03-055-12**
15,0 cm **TR-03-055-15**



Taylor

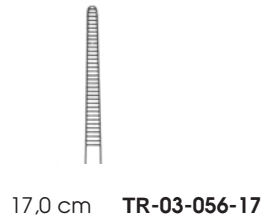

Taylor

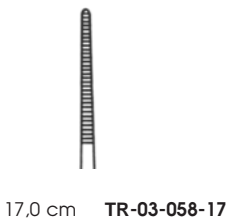

Taylor

17,0 cm **TR-03-061-17** Micro Forceps



Dressing Forceps



Potts-Smith
18,0 cm **TR-03-064-18**
21,0 cm **TR-03-064-21**
25,0 cm **TR-03-064-25**
30,0 cm **TR-03-064-30**



Potts-Smith
18,0 cm **TR-03-065-18**
21,0 cm **TR-03-065-21**
25,0 cm **TR-03-065-25**
30,0 cm **TR-03-065-30**



Cushing
17,0 cm **TR-03-066-17**



Cushing
17,0 cm **TR-03-067-17**



Brophy
20,0 cm **TR-03-068-20**



Brophy
20,0 cm **TR-03-069-20**



Gerald
18,0 cm **TR-03-070-18**
23,0 cm **TR-03-070-23**



Gerald
18,0 cm **TR-03-071-18**

Grasping Forceps



Duval

14,5 cm **TR-03-082-14**



Russ. Modell

15,0 cm **TR-03-084-15**
20,0 cm **TR-03-084-20**
25,0 cm **TR-03-084-25**
30,0 cm **TR-03-084-30**



Mayo Russ. Modell

23,0 cm **TR-03-084-23**



Wangenstein

23,0 cm **TR-03-086-23**



Tuttle

23,0 cm **TR-03-088-23**

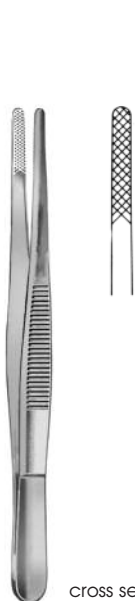

Standard

13,0 cm **TR-03-092-13**
16,0 cm **TR-03-092-16**



Selmann

16,0 cm **TR-03-094-15**
20,0 cm **TR-03-094-20**
25,0 cm **TR-03-094-25**

cross serrated

Tissue Forceps



Standard

- 10,0 cm TR-03-100-10
- 11,0 cm TR-03-100-11
- 13,0 cm TR-03-100-13
- 14,0 cm TR-03-100-14
- 15,0 cm TR-03-100-15
- 16,0 cm TR-03-100-16
- 18,0 cm TR-03-100-18
- 20,0 cm TR-03-100-20
- 23,0 cm TR-03-100-23
- 25,0 cm TR-03-100-25
- 30,0 cm TR-03-100-30



Standard

- 11,0 cm TR-03-102-11
- 13,0 cm TR-03-102-13
- 14,0 cm TR-03-102-14
- 16,0 cm TR-03-102-16
- 18,0 cm TR-03-102-18
- 20,0 cm TR-03-102-20
- 25,0 cm TR-03-102-25
- 30,0 cm TR-03-102-30

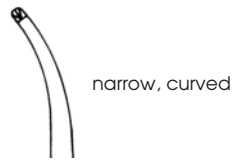

Standard

- 11,0 cm TR-03-103-11
- 13,0 cm TR-03-103-13
- 14,0 cm TR-03-103-14
- 16,0 cm TR-03-103-16
- 18,0 cm TR-03-103-18
- 20,0 cm TR-03-103-20
- 25,0 cm TR-03-103-25
- 30,0 cm TR-03-103-30

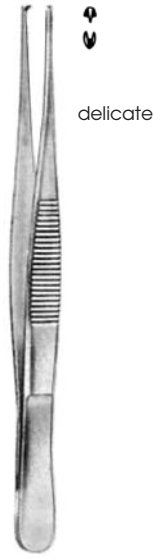

delicate

Standard

- 13,0 cm TR-03-104-13
- 14,0 cm TR-03-104-14
- 16,0 cm TR-03-104-16
- 20,0 cm TR-03-104-20



Waugh

- 18,0 cm TR-03-106-18
- 20,0 cm TR-03-106-20
- 25,0 cm TR-03-106-25
- 30,0 cm TR-03-106-30

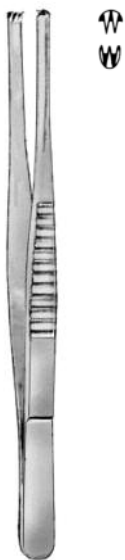

Standard USA

- 11,0 cm TR-03-120-11
- 13,0 cm TR-03-120-13
- 14,0 cm TR-03-120-14
- 15,0 cm TR-03-120-15
- 18,0 cm TR-03-120-18
- 20,0 cm TR-03-120-20
- 25,0 cm TR-03-120-25
- 30,0 cm TR-03-120-30



Standard USA

- 13,0 cm TR-03-122-13
- 14,0 cm TR-03-122-14
- 15,0 cm TR-03-122-15
- 18,0 cm TR-03-122-18
- 21,0 cm TR-03-122-21
- 25,0 cm TR-03-122-25
- 31,0 cm TR-03-122-31



Standard

- 11,0 cm TR-03-124-11
- 13,0 cm TR-03-124-13
- 14,0 cm TR-03-124-14
- 15,0 cm TR-03-124-15
- 16,0 cm TR-03-124-16
- 18,0 cm TR-03-124-18
- 20,0 cm TR-03-124-20
- 25,0 cm TR-03-124-25
- 30,0 cm TR-03-124-30



Standard

- 13,0 cm TR-03-126-13
- 14,0 cm TR-03-126-14
- 15,0 cm TR-03-126-15
- 16,0 cm TR-03-126-16



Standard

- 13,0 cm TR-03-128-13
- 14,0 cm TR-03-128-14
- 16,0 cm TR-03-128-16

Tissue Forceps



1:2



2:3



delicate, 1,0 mm



10,0 cm TR-03-134-10



10,0 cm TR-03-135-10



10,0 cm TR-03-135-11

Stille

15,0 cm TR-03-129-15

Stille

15 cm TR-03-130-15



Adson

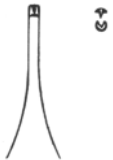

1:2



1:2



1:2



1:2



1:2

12,0 cm TR-03-140-12
15,0 cm TR-03-140-15

12,0 cm TR-03-142-12
15,0 cm TR-03-142-15

12,0 cm TR-03-144-12
15,0 cm TR-03-144-15
18,0 cm TR-03-144-18

12,0 cm TR-03-146-12

12,0 cm TR-03-147-12

Tissue Forceps

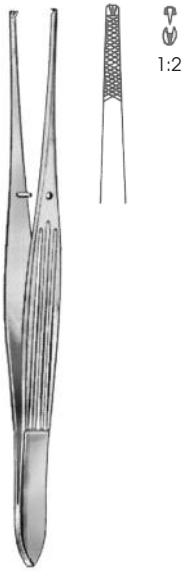

Mc Indoe
15,0 cm **TR-03-150-15**

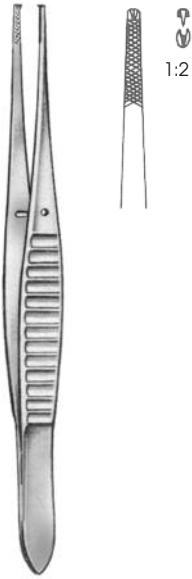

Gillies
15,0 cm **TR-03-152-15**



Semken

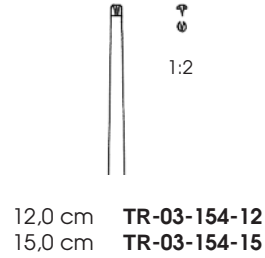

12,0 cm **TR-03-154-12**
15,0 cm **TR-03-154-15**

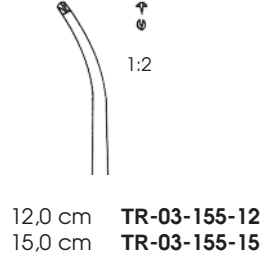

12,0 cm **TR-03-155-12**
15,0 cm **TR-03-155-15**

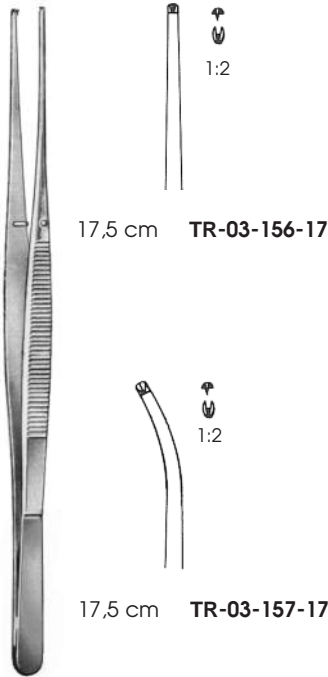

17,5 cm **TR-03-156-17**

17,5 cm **TR-03-157-17**

Taylor

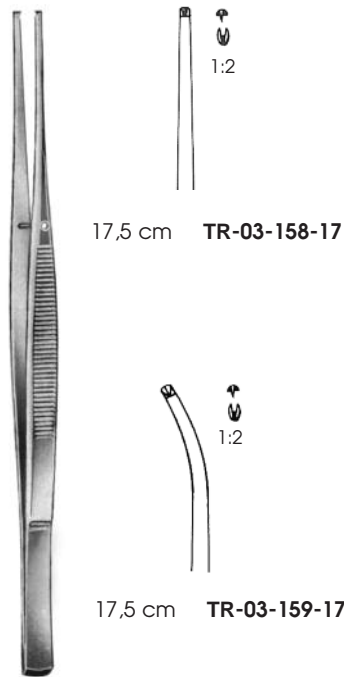

17,5 cm **TR-03-158-17**

17,5 cm **TR-03-159-17**

Taylor

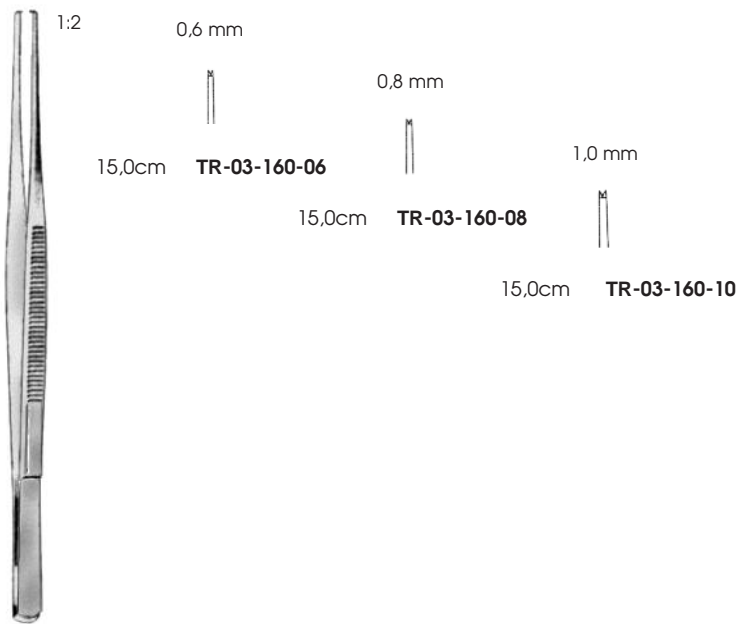

15,0cm **TR-03-160-06**

15,0cm **TR-03-160-08**

15,0cm **TR-03-160-10**

Micro-Tweezer



Taylor, Bajonett
17,0 cm **TR-03-161-17**



Potts-Smith
18,0 cm **TR-03-164-18**
21,0 cm **TR-03-164-21**
25,0 cm **TR-03-164-25**
30,0 cm **TR-03-164-30**



Potts-Smith
18,0 cm **TR-03-165-18**
21,0 cm **TR-03-165-21**
25,0 cm **TR-03-165-25**
30,0 cm **TR-03-165-30**



Cushing

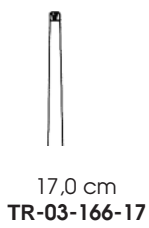

Brophy

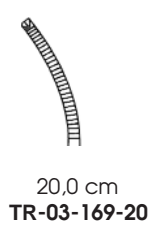
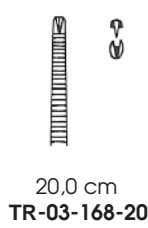

Gerald

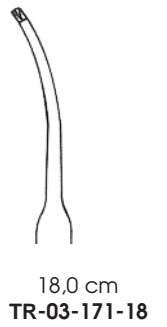
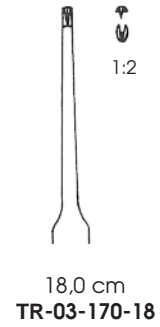

Tissue Forceps



Adlerkreuz

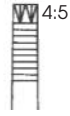

15,0 cm
TR-03-172-15



20,0 cm
TR-03-172-20

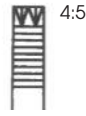

25,0 cm
TR-03-172-25

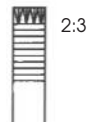

15,0 cm
TR-03-173-15

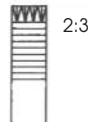

20,0 cm
TR-03-173-20

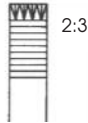

25,0 cm
TR-03-173-25



Bonney



2:3

18,0 cm **TR-03-174-18**



1:2

18,0 cm **TR-03-175-18**



Ferris-Smith

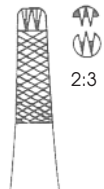

2:3

18,0 cm **TR-03-176-18**



1:2

18,0 cm **TR-03-177-18**



Lane



2:3

14,5 cm **TR-03-178-14**
20,0 cm **TR-03-178-20**



1:2

12,5 cm **TR-03-179-12**
14,5 cm **TR-03-179-14**
20,0 cm **TR-03-179-20**

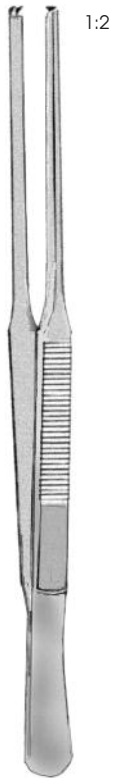

Duehrssen,
20,0 cm **TR-03-180-01**

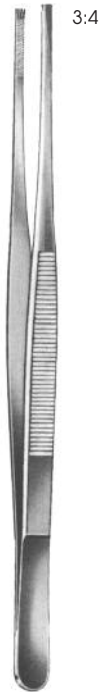

Stille-Barraya
18,0 cm **TR-03-182-18**
20,0 cm **TR-03-182-20**
23,0 cm **TR-03-182-23**
25,0 cm **TR-03-182-25**



Nelson
23,0 cm **TR-03-183-23**

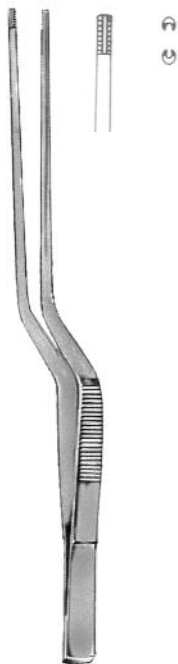

Taylor-Brown
17,0 cm **03-185-17**

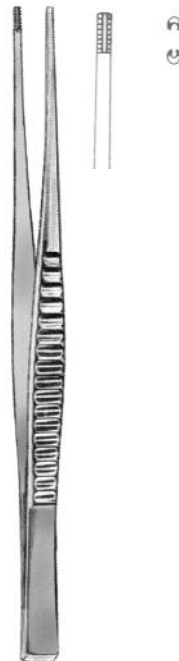

Cushing-Brown
17,0 cm **TR-03-186-17**

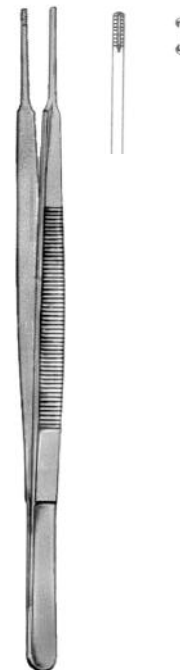

Gerald-Brown
17,0 cm **TR-03-187-17**



Brown
15,0 cm **TR-03-188-15**
20,0 cm **TR-03-188-20**
25,0 cm **TR-03-188-25**

Tissue Forceps



Adson-Brown
12,0 cm **TR-03-190-12**



Adson-Brown
12,0 cm **TR-03-191-12**
15,0 cm **TR-03-191-15**

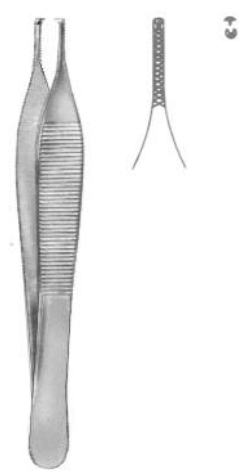

Adson
12,0 cm **TR-03-192-12**

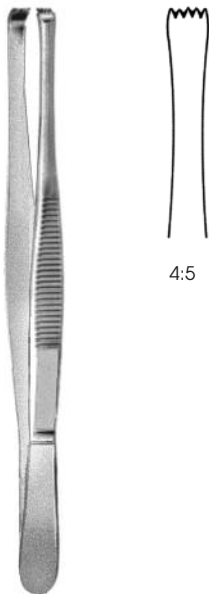

Stone
13,0 cm **TR-03-194-13**
15,0 cm **TR-03-194-15**

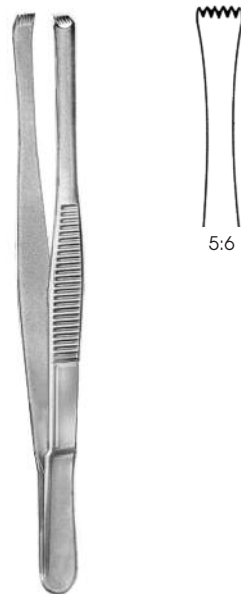

Lerche
15,0 cm **TR-03-196-15**

Atraumatic Tissue Forceps



De Bakay

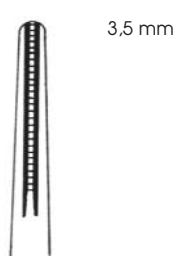

16,0 cm
TR-03-200-16

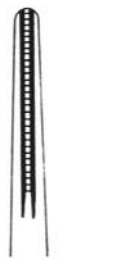

20,0 cm
TR-03-200-20



24,0 cm
TR-03-200-24



30,0 cm
TR-03-200-30

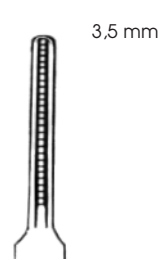

16,0 cm
TR-03-202-16

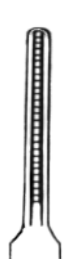

20,0 cm
TR-03-202-20

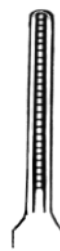

24,0 c
TR-03-202-24

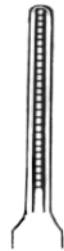

30,0 cm
TR-03-202-30



De Bakay



De Bakay

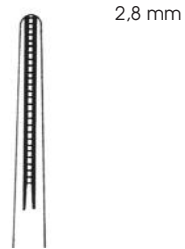

16,0 cm
TR-03-204-16

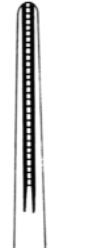

20,0 cm
TR-03-204-20



24,0 cm
TR-03-204-24



30,0 cm
TR-03-204-30



De Bakay

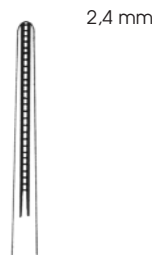

16,0 cm
TR-03-206-16

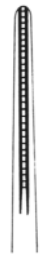

20,0 cm
TR-03-206-20



24,0 cm
TR-03-206-24



30,0 cm
TR-03-206-30

Atraumatic Tissue Forceps

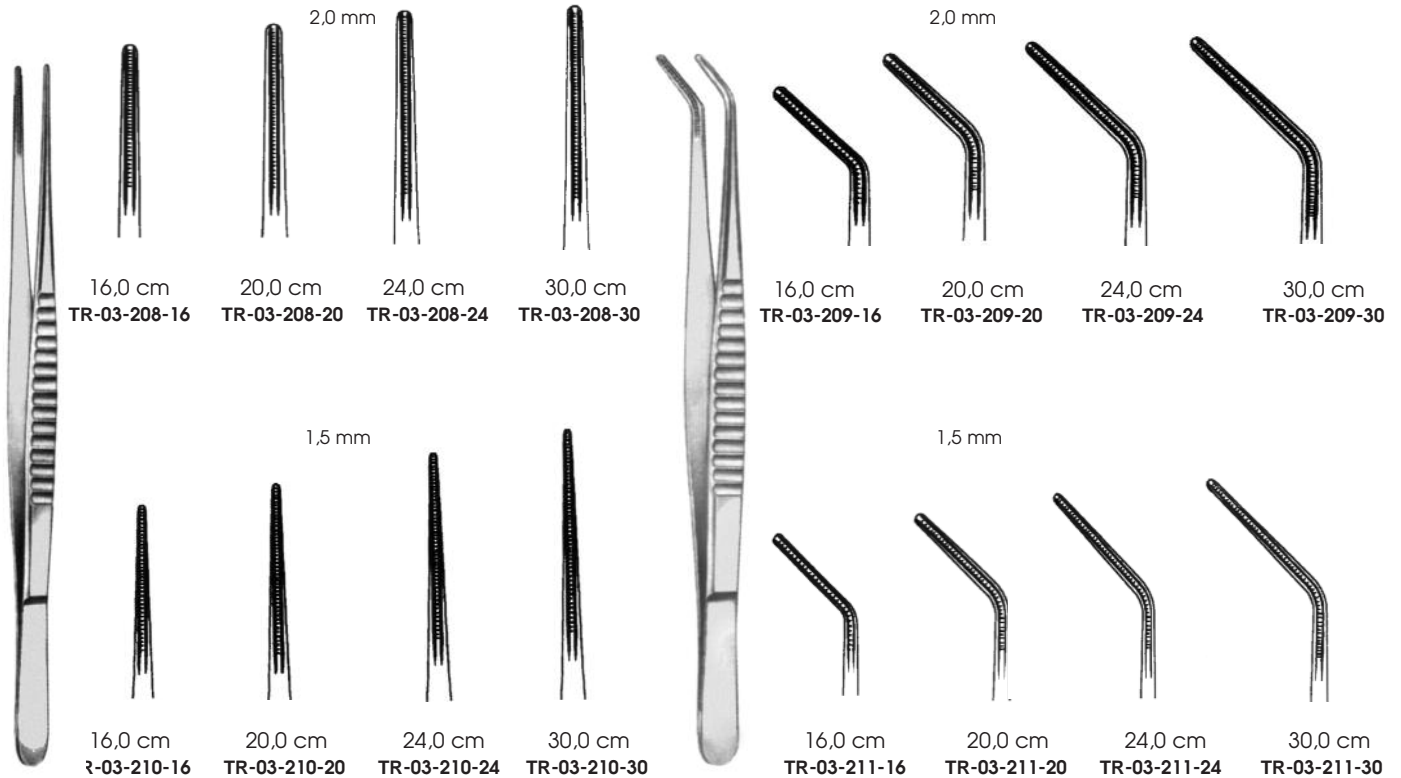

De Bakley

De Bakley



De Bakley

Cooley



Trölsch



11,0 cm **TR-03-401-11**
12,0 cm **TR-03-401-12**
15,0 cm **TR-03-401-15**
18,0 cm **TR-03-401-18**



15,0 cm **TR-03-403-15**



Trölsch



13,0 cm **TR-03-405-13**



Lucae



13,5 cm **TR-03-407-14**



13,5 cm **TR-03-409-14**



Jansen

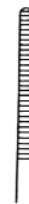

16,0 cm **TR-03-411-16**
18,0 cm **TR-03-411-18**
20,0 cm **TR-03-411-20**

Ear and Nose Dressing Forceps



Gerald
18,0 cm TR-03-413-18



Gerald
18,0 cm TR-03-415-18



Grünwald-Jansen



20,0 cm TR-03-417-20



20,0 cm TR-03-419-20

Cilia and Splinter Forceps



Douglas

9,0 cm **TR-03-500-09**



Shaaf

9,0 cm **TR-03-502-09**



Beer

9,0 cm **TR-03-504-09**



Cilien

9,0 cm **TR-03-508-09**



Liffauer

9,0 cm **TR-03-510-08**



Barraquer

10,5 cm **TR-03-511-10**



Splinter Forceps

8,0 cm **TR-03-512-08**
 9,0 cm **TR-03-512-09**
 10,0 cm **TR-03-512-10**
 11,0 cm **TR-03-512-11**
 12,0 cm **TR-03-512-12**
 14,0 cm **TR-03-512-14**

8,0 cm **TR-03-513-08**
 9,0 cm **TR-03-513-09**
 10,0 cm **TR-03-513-10**
 11,0 cm **TR-03-513-11**
 12,0 cm **TR-03-513-12**
 14,0 cm **TR-03-513-14**

Cilia and Splinter Forceps



8,0 cm **TR-03-514-08**
9,0 cm **TR-03-514-09**
10,0 cm **TR-03-514-10**
11,0 cm **TR-03-514-11**
12,0 cm **TR-03-514-12**
14,0 cm **TR-03-514-14**



8,0 cm **TR-03-515-08**
9,0 cm **TR-03-515-09**
10,0 cm **TR-03-515-10**
11,0 cm **TR-03-515-11**
12,0 cm **TR-03-515-12**
14,0 cm **TR-03-515-14**



Carmalt



10,0 cm **TR-03-516-10**



10,0 cm **TR-03-517-10**



Hunter

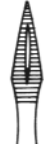

10,0 cm **TR-03-518-10**



10,0 cm **TR-03-519-10**

Splinter Forceps

JEWELER TYPE FORCEPS



Feilchenfeld

7,5 cm **TR-03-522-07**
9,0 cm **TR-03-522-09**
11,5 cm **TR-03-522-11**



Watchmaker Tweezers

11,0 cm **TR-03-524-11**
12



Watchmaker Tweezers

12,0 cm **TR-03-524-12**



Watchmaker Tweezers

12,0 cm **TR-03-525-12**



Splinter Forceps with magnifying glass

12,0 cm **TR-03-528-**



Austin

14,0 cm **TR-03-600-14**
18,0 cm **TR-03-600-18**

0,8 mm



Lazar

0,8 mm



15,0 cm
TR-03-602-1

0,5 mm



15,0 cm
TR-03-603-1

0,5 mm



18,0 cm
TR-03-604-18

0,3 mm



Vise

12,0 cm **TR-03-606-12**

0,3 mm



13,0 cm **TR-03-608-13**

0,3 mm



13,0 cm **TR-03-609-13**

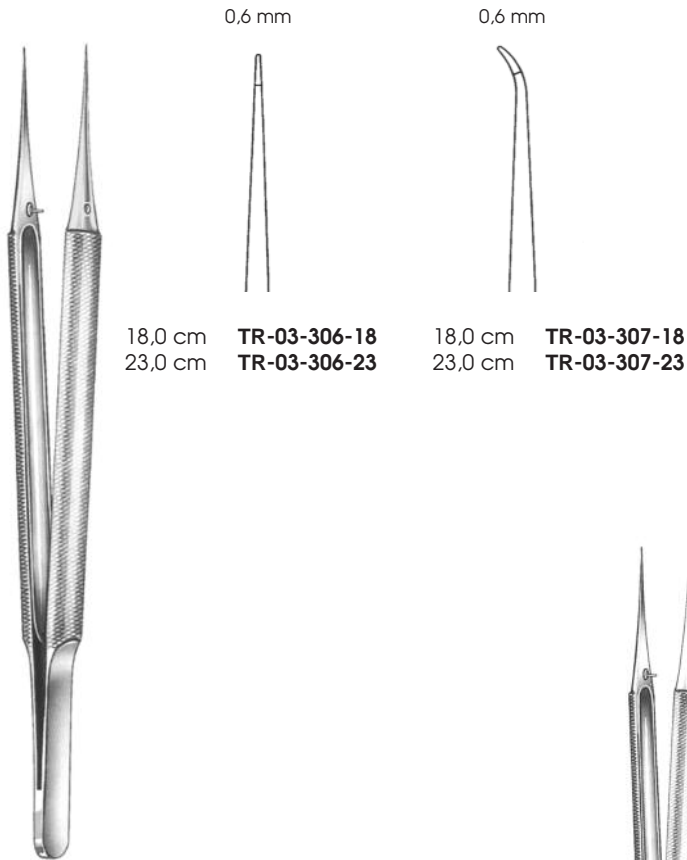

Suture Tying Forceps

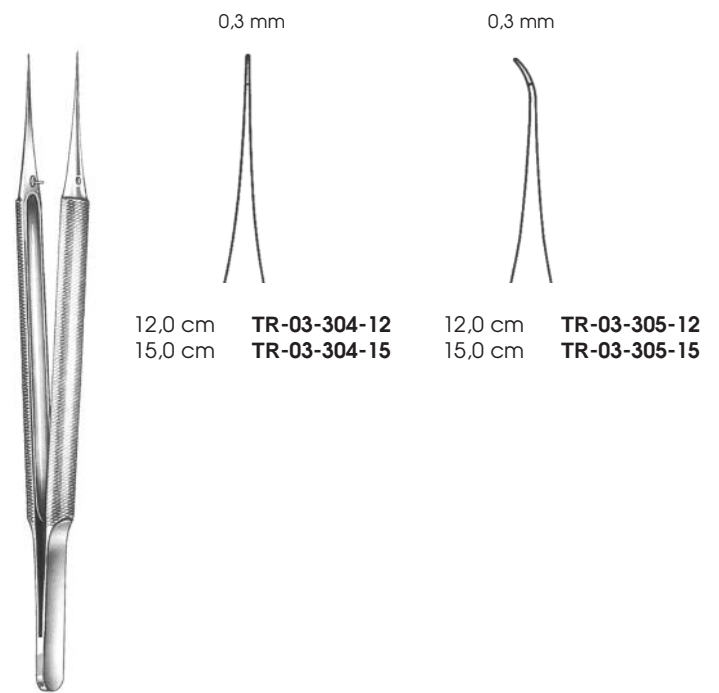

Suture Tying Forceps

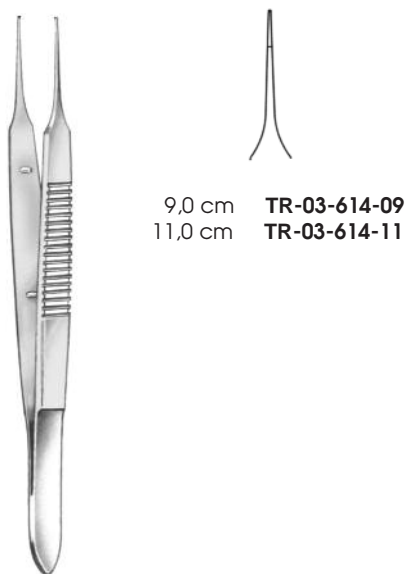

Micro Suture Tying Forceps

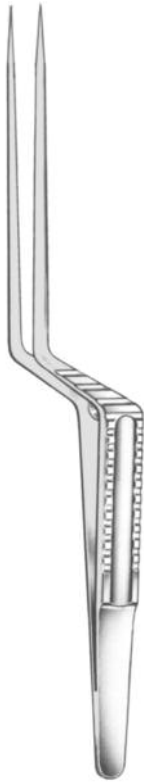

Hunt, bayonet



18,0 cm **TR-03-620-01**



18,0 cm **TR-03-620-02**



18,0 cm **TR-03-620-03**



Yasargil, bayonet



16,0 cm **TR-03-621-16**
18,0 cm **TR-03-621-18**
20,0 cm **TR-03-621-20**
22,0 cm **TR-03-621-22**
24,0 cm **TR-03-621-24**



16,0 cm **TR-03-623-16**
18,0 cm **TR-03-623-18**
20,0 cm **TR-03-623-20**
22,0 cm **TR-03-623-22**
24,0 cm **TR-03-623-24**



16,0 cm **TR-03-624-16**

Micro Forceps



Ø 3 mm

 24,0 cm **TR-03-625-24**

Ø 5 mm

 24,0 cm **TR-03-627-24**

Ø 7 mm

 24,0 cm **TR-03-629-24**

Yasargil-Samii



Ø 3 mm

 22,0 cm **TR-03-631-22**

Ø 5 mm

 22,0 cm **TR-03-633-22**

Ø 3 mm

 22,0 cm **TR-03-635-22**

Ø 5 mm

 22,0 cm **TR-03-637-22**

Yasargil



Ø 3 mm

 22,0 cm **TR-03-639-22**

Ø 5 mm

 22,0 cm **TR-03-641-22**

Heifetz

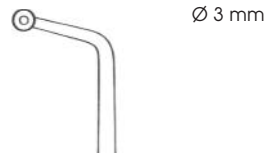

Samii



23,0 cm **TR-03-643-23**



23,0 cm **TR-03-649-23**

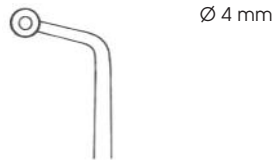

23,0 cm **03-645-23**



23,0 cm **03-651-23**

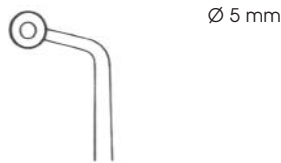

23,0 cm **TR-03-647-23**



23,0 cm **TR-03-653-23**

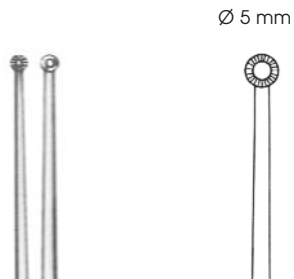

20,0 cm **Hunt**
TR-03-655-20



20,0 cm **Yasargil**
TR-03-657-20

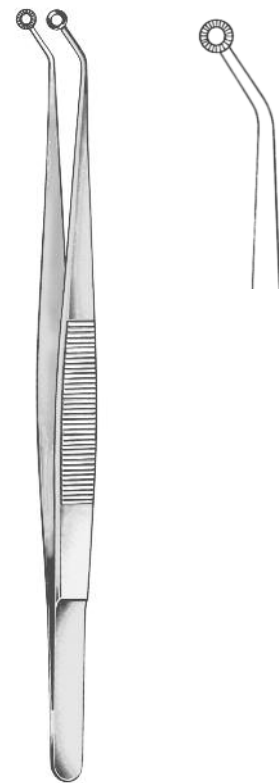

20,0 cm **Hunt**
TR-03-659-20



04

TC-Forceps

TC-Dissecting Forceps



Standard

- 14,0 cm **TR-04-002-14**
- 20,0 cm **TR-04-002-20**
- 25,0 cm **TR-04-002-25**



fine

Standard

- 14,0 cm **TR-04-004-14**
- 18,0 cm **TR-04-004-18**
- 20,0 cm **TR-04-004-20**
- 25,0 cm **TR-04-004-25**



Adson

- 12,0 cm **TR-04-044-12**
- 15,0 cm **TR-04-044-15**



Mc Indoe

- 15,0 cm **TR-04-050-15**



Semken

- 12,0 cm **TR-04-054-12**
- 15,0 cm **TR-04-054-15**



Taylor

- 18,0 cm **TR-04-061-18**



Potts-Smith

- 15,0 cm **TR-04-064-15**
- 18,0 cm **TR-04-064-18**
- 20,0 cm **TR-04-064-20**
- 23,0 cm **TR-04-064-23**
- 25,0 cm **TR-04-064-25**



Cushing

- 18,0 cm **TR-04-066-18**
- 23,0 cm **TR-04-066-23**



18,0 cm **TR-04-067-18**



Gerald
18,0 cm **TR-04-070-18**



Bonney
18,0 cm **TR-04-075-18**



Wangenstein
15,0 cm **TR-04-086-15**
23,0 cm **TR-04-086-23**
25,0 cm **TR-04-086-25**



Standard
14,0 cm **TR-04-102-14**
16,0 cm **TR-04-102-16**
18,0 cm **TR-04-102-18**
20,0 cm **TR-04-102-20**
25,0 cm **TR-04-102-25**



Adson
12,0 cm **TR-04-142-12**
15,0 cm **TR-04-142-15**



Adson
12,0 cm **TR-04-144-12**
15,0 cm **TR-04-144-15**



Gillies
15,0 cm **TR-04-152-15**



Semken



15,0 cm **TR-04-154-15**



18,0 cm **TR-04-154-18**

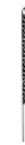

16,0 cm **TR-04-156-16**



18,0 cm **TR-04-156-18**

TC-Dissecting Forceps

1:2



Gerald

18,0 cm **TR-04-170-18**

1:2



Bonney

18,0 cm **TR-04-175-18**

7:7



Adson-Brown

12,0 cm **TR-04-191-12**

2,0 mm



De Bakey



16,0 cm
TR-04-208-16



20,0 cm
TR-04-208-20



24,0 cm
TR-04-208-24

1,5 mm



De Bakey



16,0 cm
TR-04-210-16



20,0 cm
TR-04-210-20



24,0 cm
TR-04-210-24

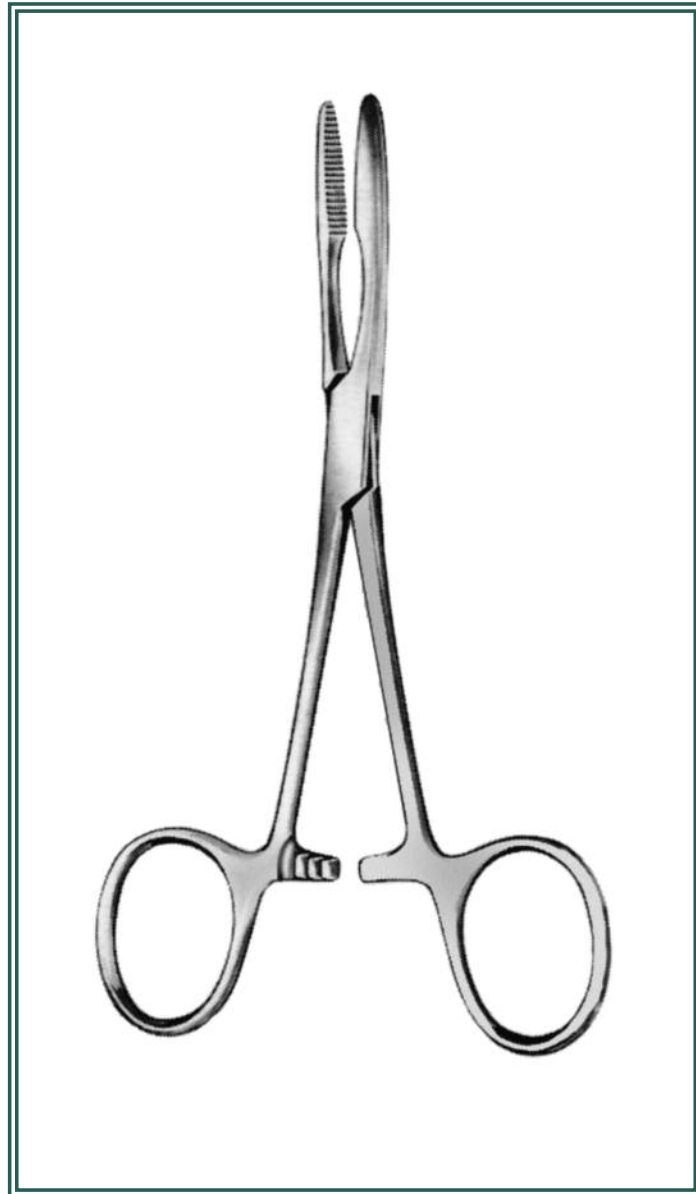

05

Forceps, Clamps, Clips

Haemostatic Forceps

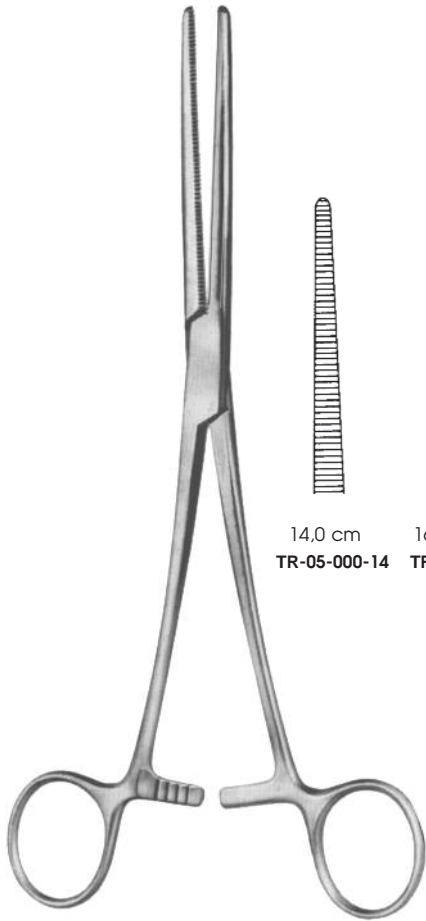

Rochester-Péan

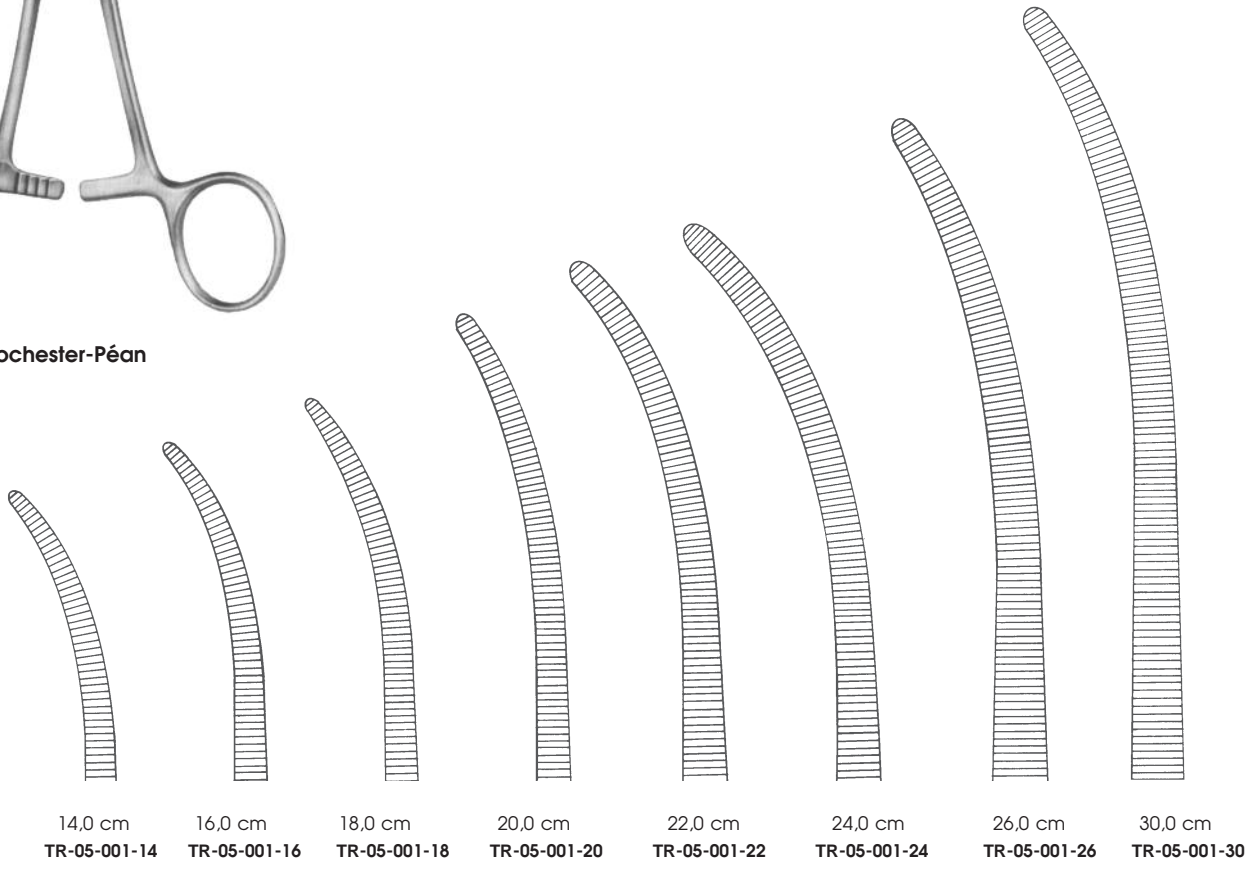
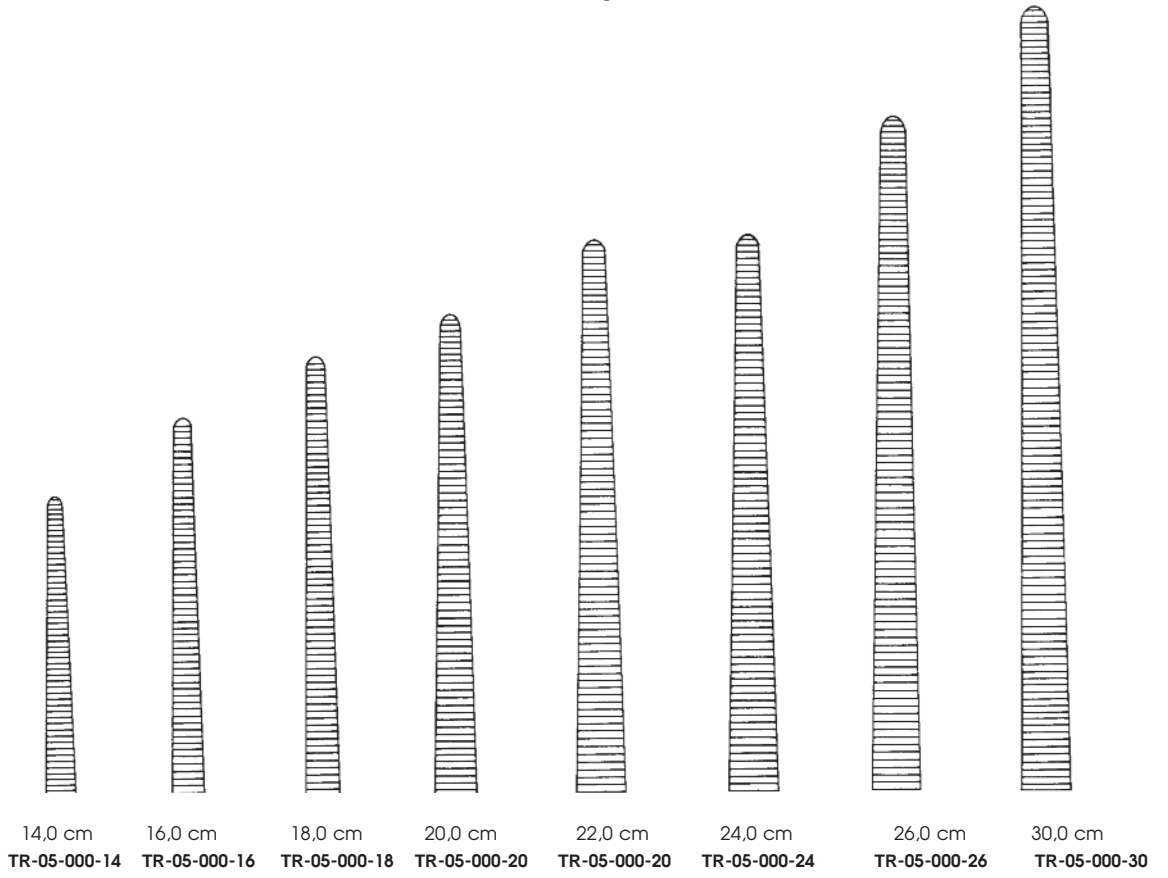



14,0 cm **TR-05-004-14**
16,0 cm **TR-05-004-16**
18,0 cm **TR-05-004-18**



14,0 cm **TR-05-005-14**
16,0 cm **TR-05-005-16**
18,0 cm **TR-05-005-18**

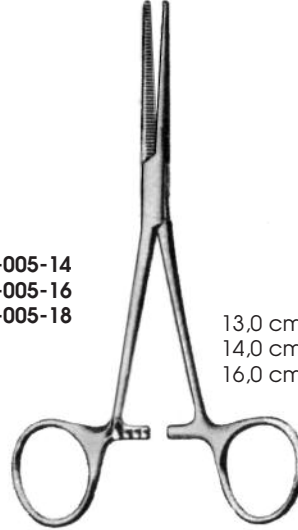

13,0 cm **TR-05-010-13**
14,0 cm **TR-05-010-14**
16,0 cm **TR-05-010-16**



13,0 cm **TR-05-011-13**
14,0 cm **TR-05-011-14**
16,0 cm **TR-05-011-16**

Péan-Nippon

Péan, grazil



Péan
12,0 cm **TR-05-012-12**
14,0 cm **TR-05-012-14**
16,0 cm **TR-05-012-16**



13,0 cm **TR-05-014-13**
14,0 cm **TR-05-014-14**
15,0 cm **TR-05-014-15**
18,0 cm **TR-05-014-18**
20,0 cm **TR-05-014-20**



13,0 cm **TR-05-015-13**
14,0 cm **TR-05-015-14**
15,0 cm **TR-05-015-15**
18,0 cm **TR-05-015-18**
20,0 cm **TR-05-015-20**

Spencer-Wells

Haemostatic Forceps

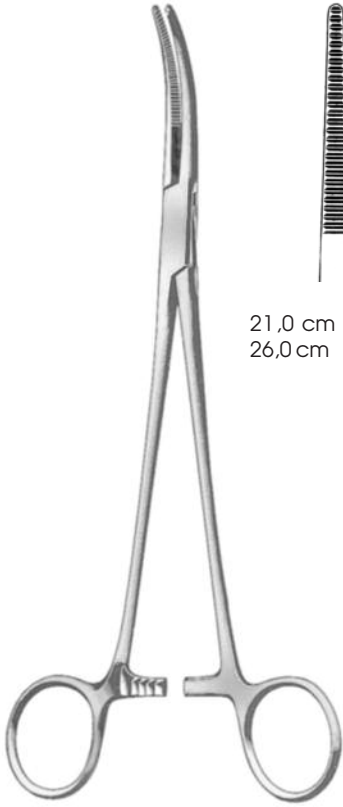

21,0 cm **TR-05-018-21**
26,0 cm **TR-05-018-26**



21,0 cm **TR-05-019-21**
26,0 cm **TR-05-019-26**

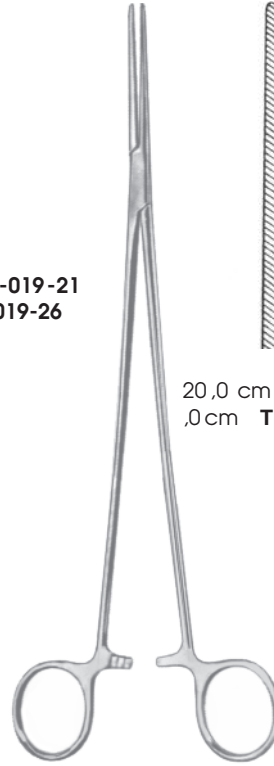

20,0 cm **TR-05-020-20** 20,0 cm **TR-05-021-20**
26,0 cm **TR-05-020-26** 26,0 cm **TR-05-021-26**

Toennis

Bengolea



20,0 cm **TR-05-022-20**



20,0 cm **TR-05-023-20**



20,0 cm **TR-05-025-20**

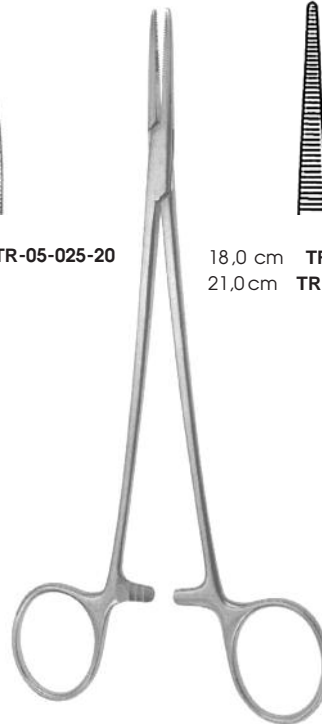

18,0 cm **TR-05-026-18**
21,0 cm **TR-05-026-21**

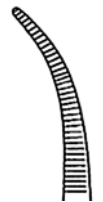

18,0 cm **TR-05-027-18**
21,0 cm **TR-05-027-21**

Heiss

Halsted-Mosquito

Haemostatic Forceps



18,0 cm **TR-05-029-18**

Schnidt



19,0 cm **TR-05-029-19**

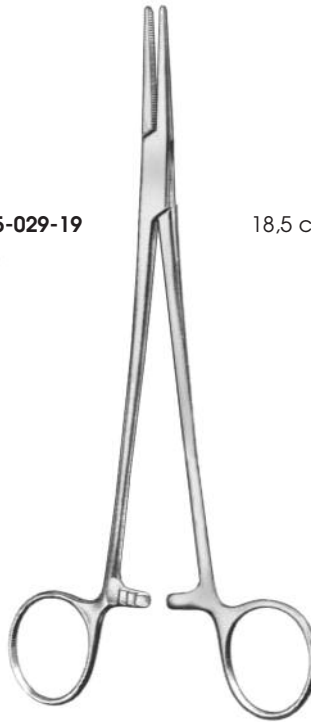

Adson



18,5 cm **TR-05-030-18**



19,0 cm **TR-05-031-19**



Mikro-Adson
14,0 cm **TR-05-033-14**



Rochester-Carmalt



16,0 cm
TR-05-034-1



20,0 cm
TR-05-034-2



16,0 cm
TR-05-035-1

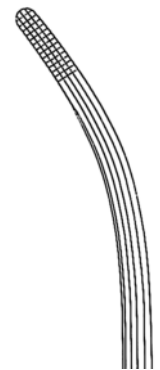

20,0 cm
TR-05-035-20

Haemostatic Forceps



15,0 cm **TR-05-036-15**
18,0 cm **TR-05-036-18**

Brainbridge



15,0 cm **TR-05-037-15**
18,0 cm **TR-05-037-18**



16,0 cm **TR-05-038-16** 16,0 cm **TR-05-039-16**

Crile-Rankin



16,0 cm **TR-05-043-16**

Kelly-Rankin

16,0 cm **TR-05-042-16**

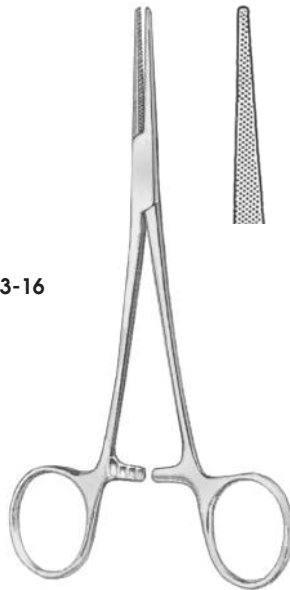

15,0 cm **TR-05-044-15**

Dixon-Lovelace



20,0 cm **TR-05-045-20**

Fuchsig

Haemostatic Forceps



15,0 cm **TR-05-046-15**

Leriche

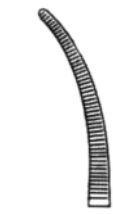

15,0 cm **TR-05-047-15**

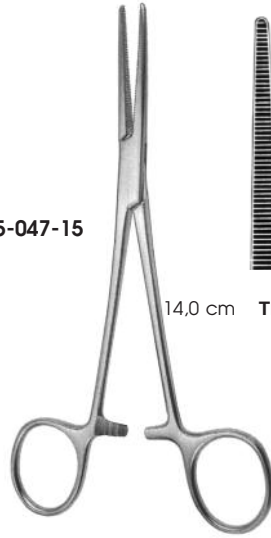

14,0 cm **TR-05-048-14**

Crile



14,0 cm **TR-05-049-14**

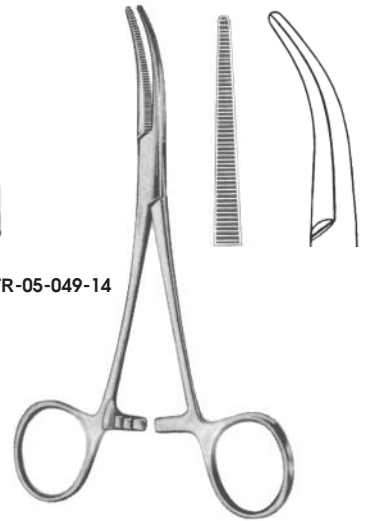

Dandy

12,0 cm **TR-05-051-12**

14,0 cm **TR-05-051-14**



14,0 cm **TR-05-052-14**

Kelly



14,0 cm **TR-05-053-14**



14,0 cm **TR-05-054-14**

Providence-Hospital



14,0 cm **TR-05-055-14**

Haemostatic Forceps



Halsted-Mosquito



12,0 cm
TR-05-060-12



14,0 cm
TR-05-060-14



12,0 cm
TR-05-061-12



14,0 cm
TR-05-061-14



10,0 cm
TR-05-062-10

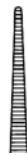

12,0 cm
TR-05-062-12



10,0 cm
TR-05-063-10



12,0 cm
TR-05-063-12



Mikro-Mosquito



Baby-Mosquito



10,0 cm
TR-05-064-10



10,0 cm
TR-05-065-10

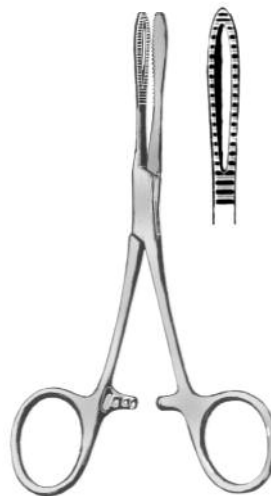

Krönlein
13,0 cm TR-05-072-13

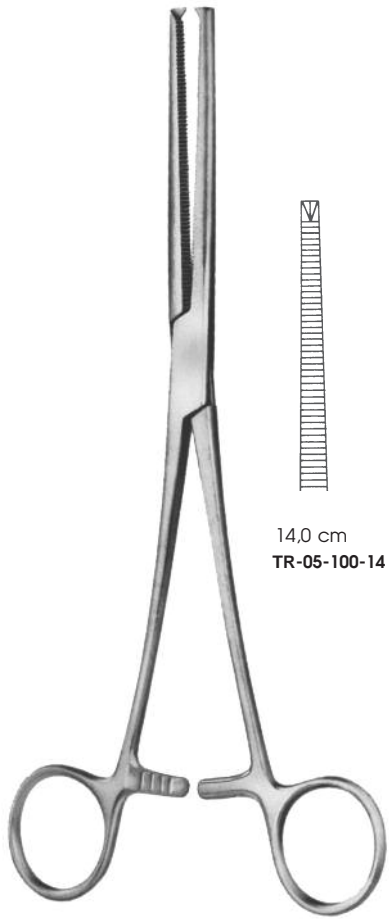

Ochsner-Kocher

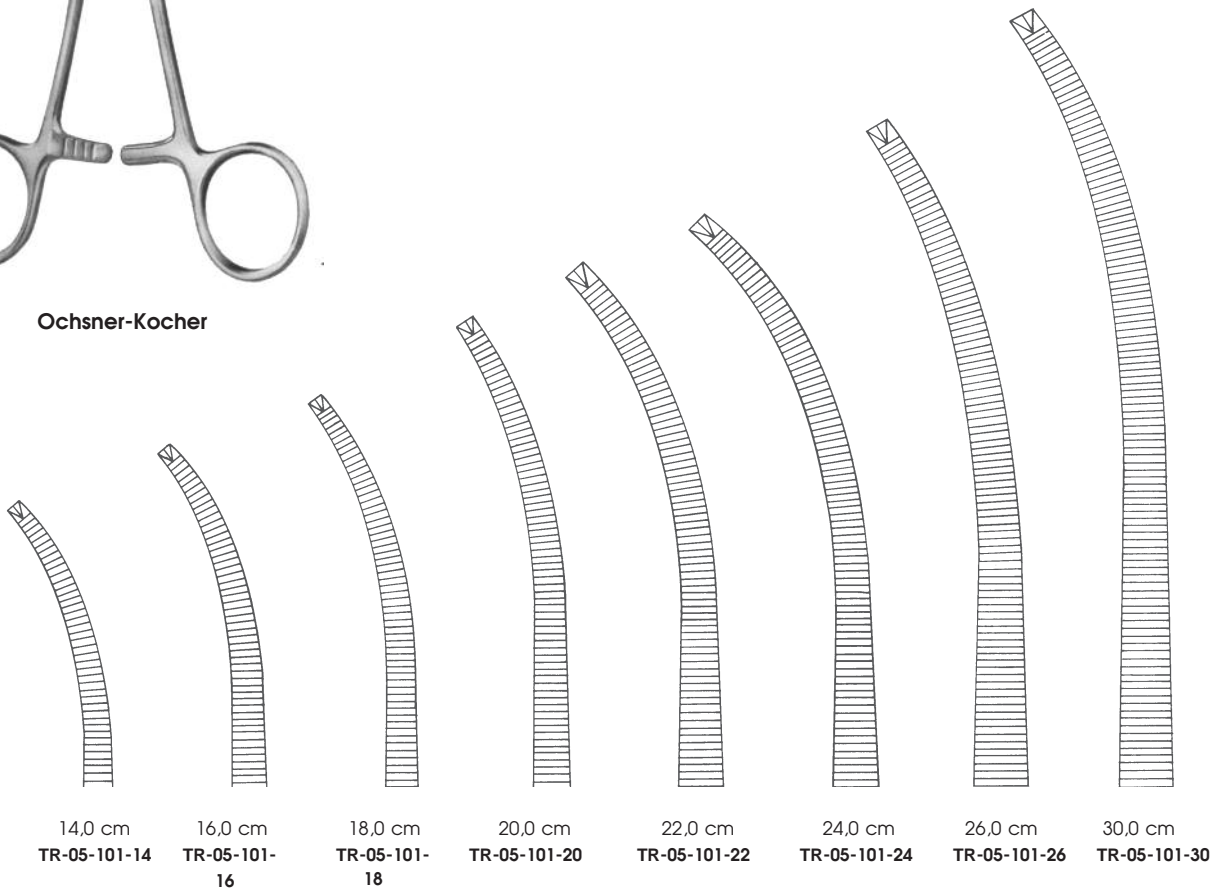
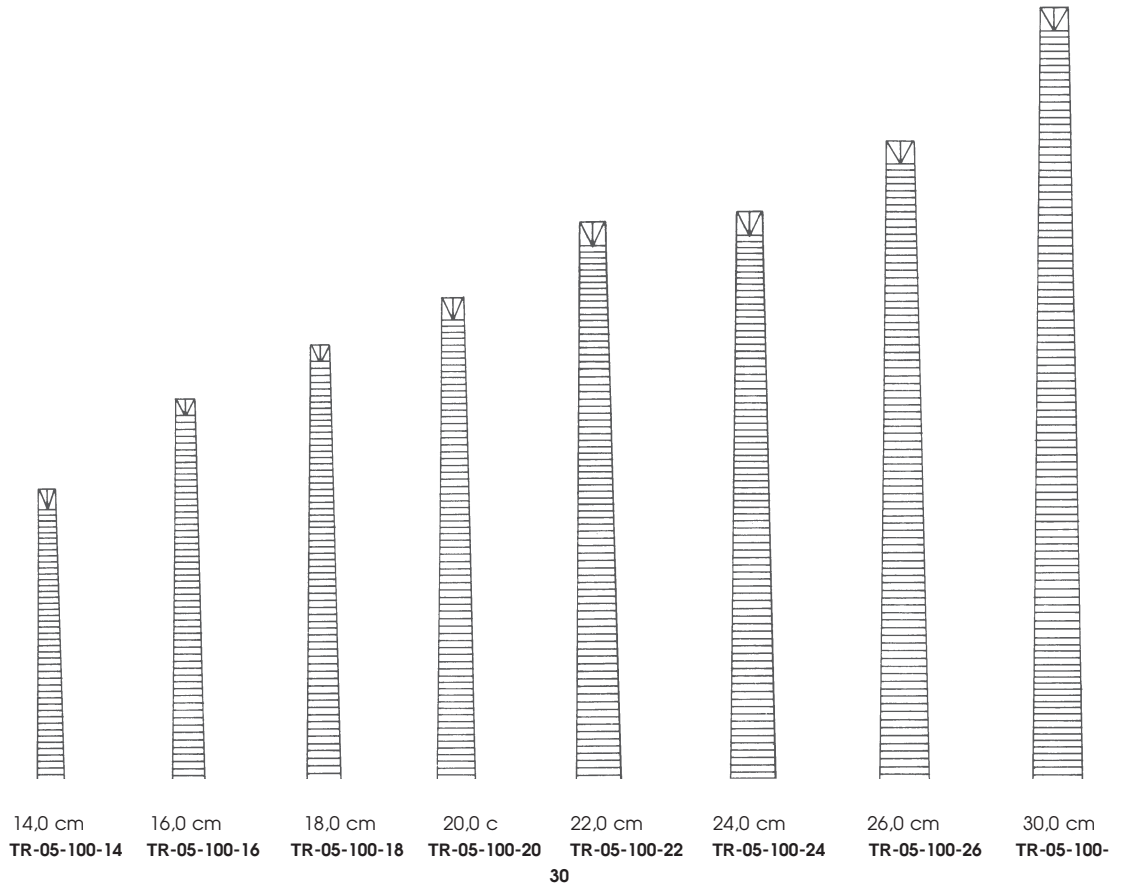

Haemostatic Forceps



Kocher-Nippon

14,5 cm **TR-05-104-14**
16,0 cm **TR-05-104-16**
18,0 cm **TR-05-104-18**



14,5 cm **TR-05-105-14**
16,0 cm **TR-05-105-16**
18,0 cm **TR-05-105-18**



Kocher

13,0 cm **TR-05-110-13**
14,0 cm **TR-05-110-14**
16,0 cm **TR-05-110-16**

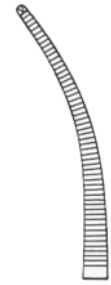

13,0 cm **TR-05-111-13**
14,0 cm **TR-05-111-14**
16,0 cm **TR-05-111-16**

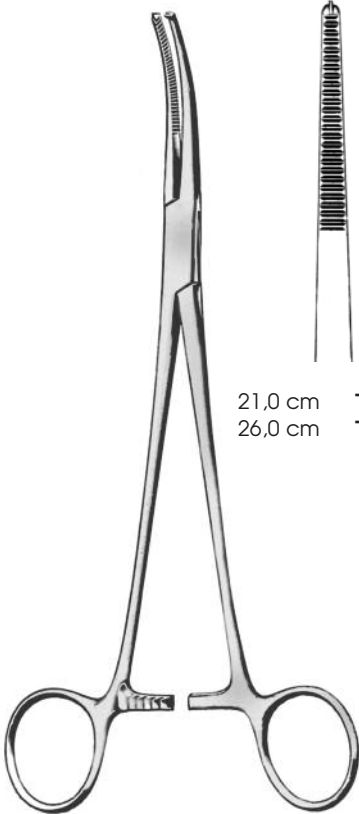

Toennis

21,0 cm **TR-05-112-21**
26,0 cm **TR-05-112-26**



21,0 cm **TR-05-113-21**
26,0 cm **TR-05-113-26**

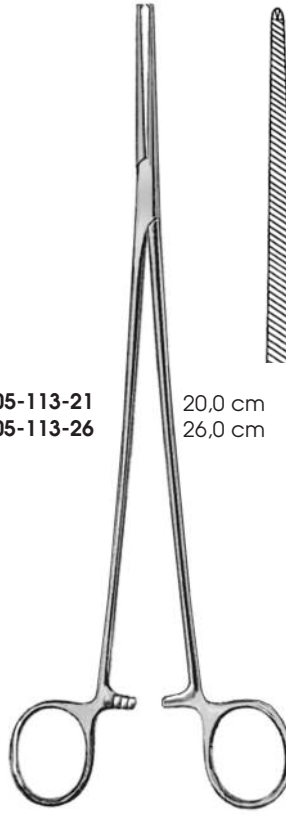

Bengolea

20,0 cm **TR-05-120-20**
26,0 cm **TR-05-120-26**



20,0 cm **TR-05-121-20**
26,0 cm **TR-05-121-26**

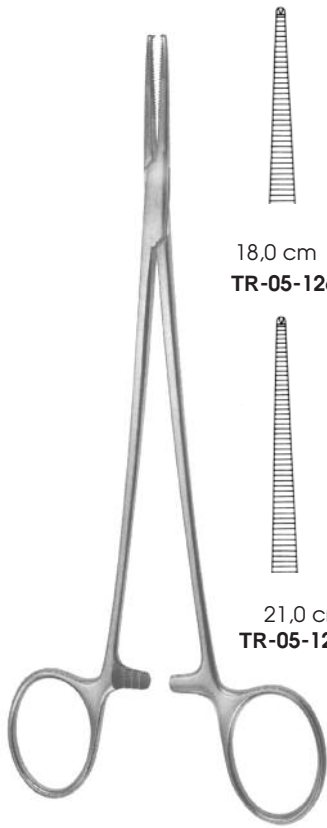

18,0 cm
TR-05-126-18

21,0 cm
TR-05-126-21

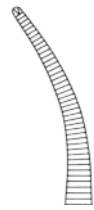

18,0 cm
TR-05-127-18

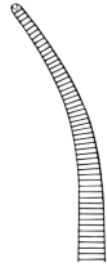

21,0 cm
TR-05-127-21

Halsted-Mosquito

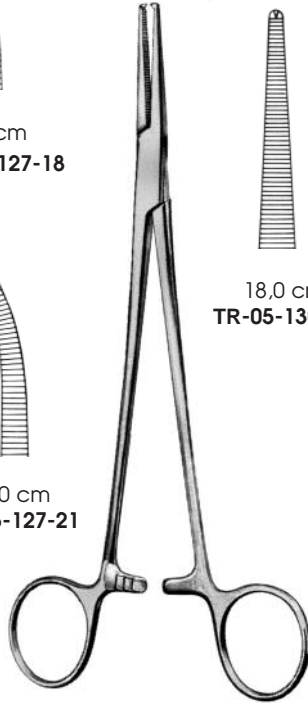

18,0 cm
TR-05-130-18

Adson



18,0 cm
TR-05-131-18

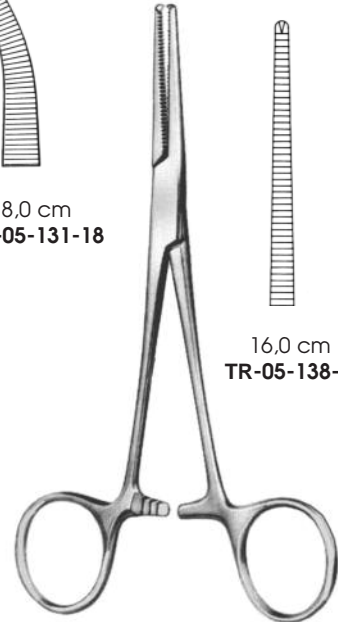

16,0 cm
TR-05-138-16

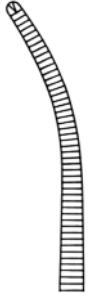

16,0 cm
TR-05-139-16

Crile-Rankin



15,0 cm
TR-05-144-15

Dixon-Lovelace



15,0 cm
TR-05-146-15

Leriche



15,0 cm
TR-05-147-15

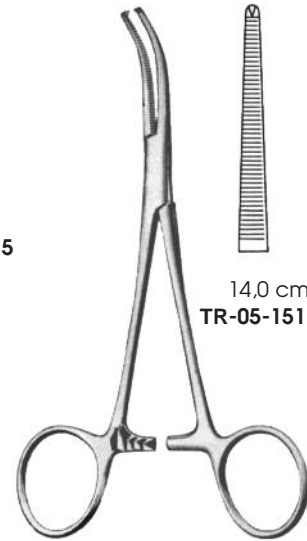

14,0 cm
TR-05-151-14

Dandy

Haemostatic Forceps



Halsted-Mosquito



12,0 cm
TR-05-160-12



14,0 cm
TR-05-160-14



12,0 cm
TR-05-161-12



14,0 cm
TR-05-161-14



10,0 cm
TR-05-162-10



12,0 cm
TR-05-162-12



10,0 cm
TR-05-163-10



12,0 cm
TR-05-163-12



Mikro-Mosquito



Terrier
8,0 cm TR-05-166-08



Overholt-Geissendörfer

21,0 cm	TR-05-201-01	TR-05-201-02	TR-05-201-03	TR-05-201-04	TR-05-201-05	TR-05-201-06	TR-05-201-07
27,0 cm	TR-05-203-01	TR-05-203-02	TR-05-203-03	TR-05-203-04	TR-05-203-05	TR-05-203-06	TR-05-203-07

18,5 cm	20,5 cm	21,0 cm	21,5 cm
TR-05-217-01	TR-05-217-02	TR-05-217-03	TR-05-217-04

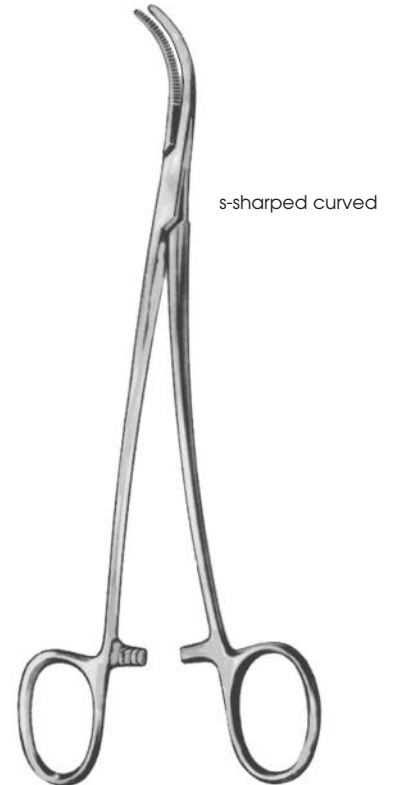

Overholt

Dissecting Forceps



30,0 cm TR-05-225-30

Zenker

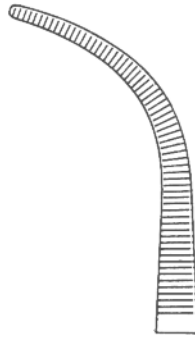

30,0 cm TR-05-231-30



Lawrence
28,0 cm TR-05-233-28

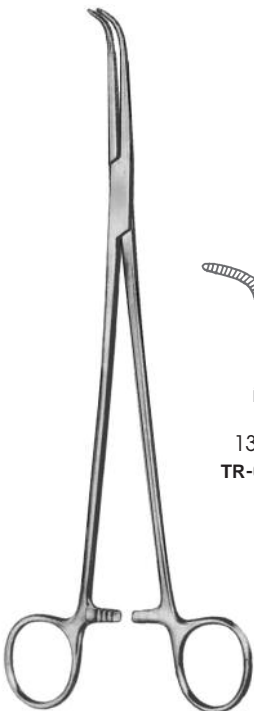

Gemini

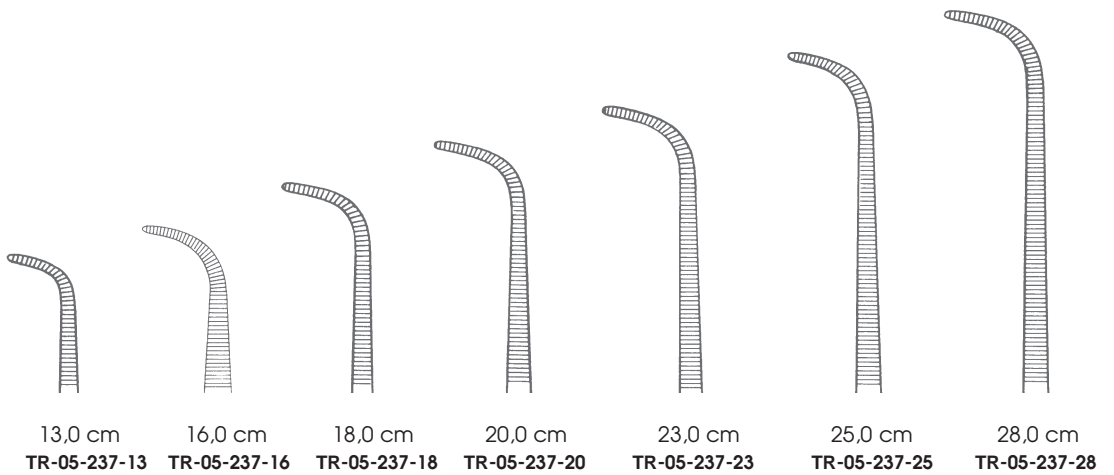

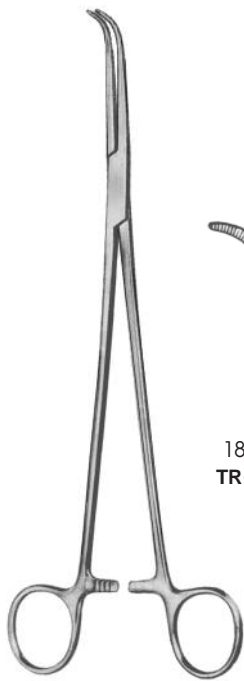

18,0 cm
TR-05-239-18

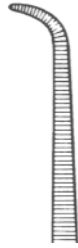
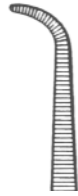

22,0 cm
TR-05-239-22

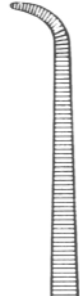

25,0 cm
TR-05-239-25

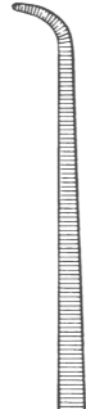

28,0 cm
TR-05-239-28

Mini-Gemini



Meeker
18,0 cm TR-05-243-18
28,0 cm TR-05-243-28

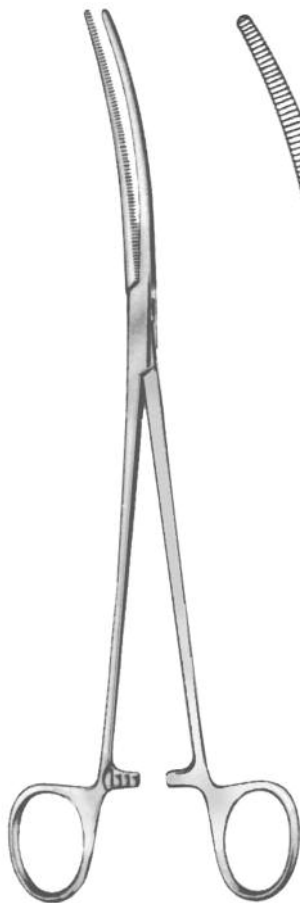

Craford
18,0 cm TR-05-245-18
24,0 cm TR-05-245-24

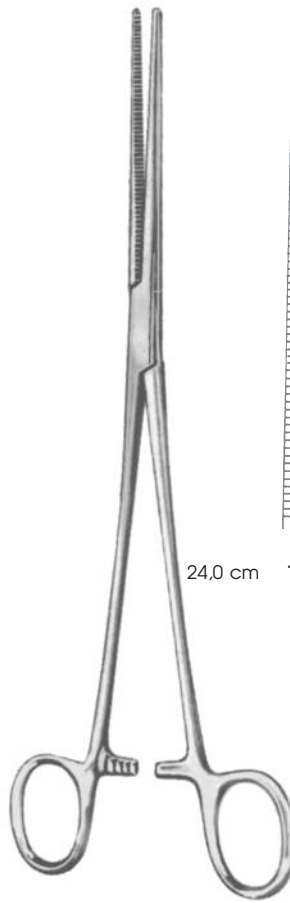
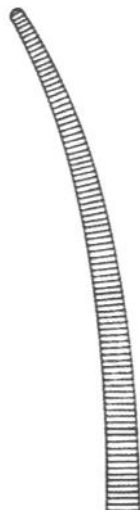

Sarot

24,0 cm TR-05-248-24

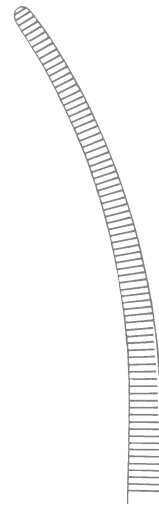

24,0 cm TR-05-249-24

Haemostatic Forceps

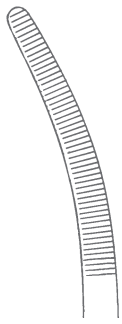

23,0 cm
TR-05-251-23

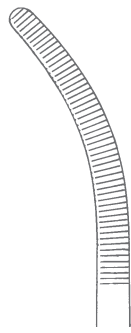

23,0 cm
TR-05-252-23

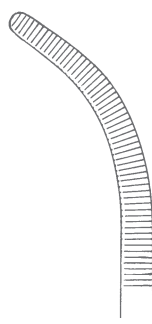

23,0 cm
TR-05-253-23

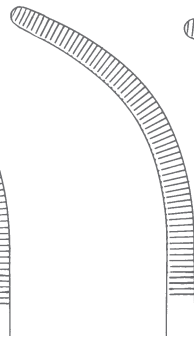

23,0 cm
TR-05-255-23

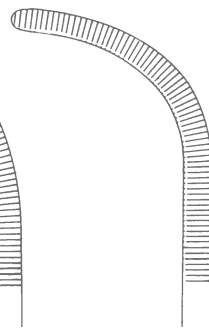

23,0 cm
TR-05-257-23



Rumel



Mixer
23,0 cm **TR-05-259-23**



Overholt-Mixer
21,0 cm **TR-05-261-21**



Mixer
15,0 cm **TR-05-263-15**
19,0 cm **TR-05-263-19**

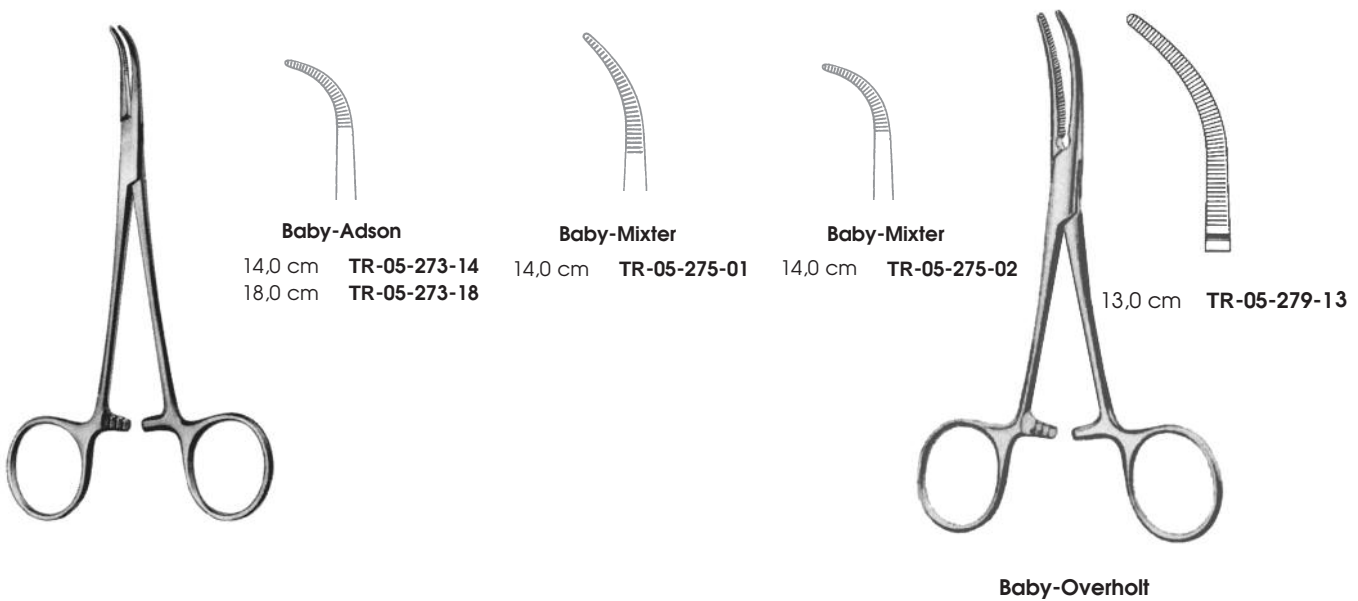
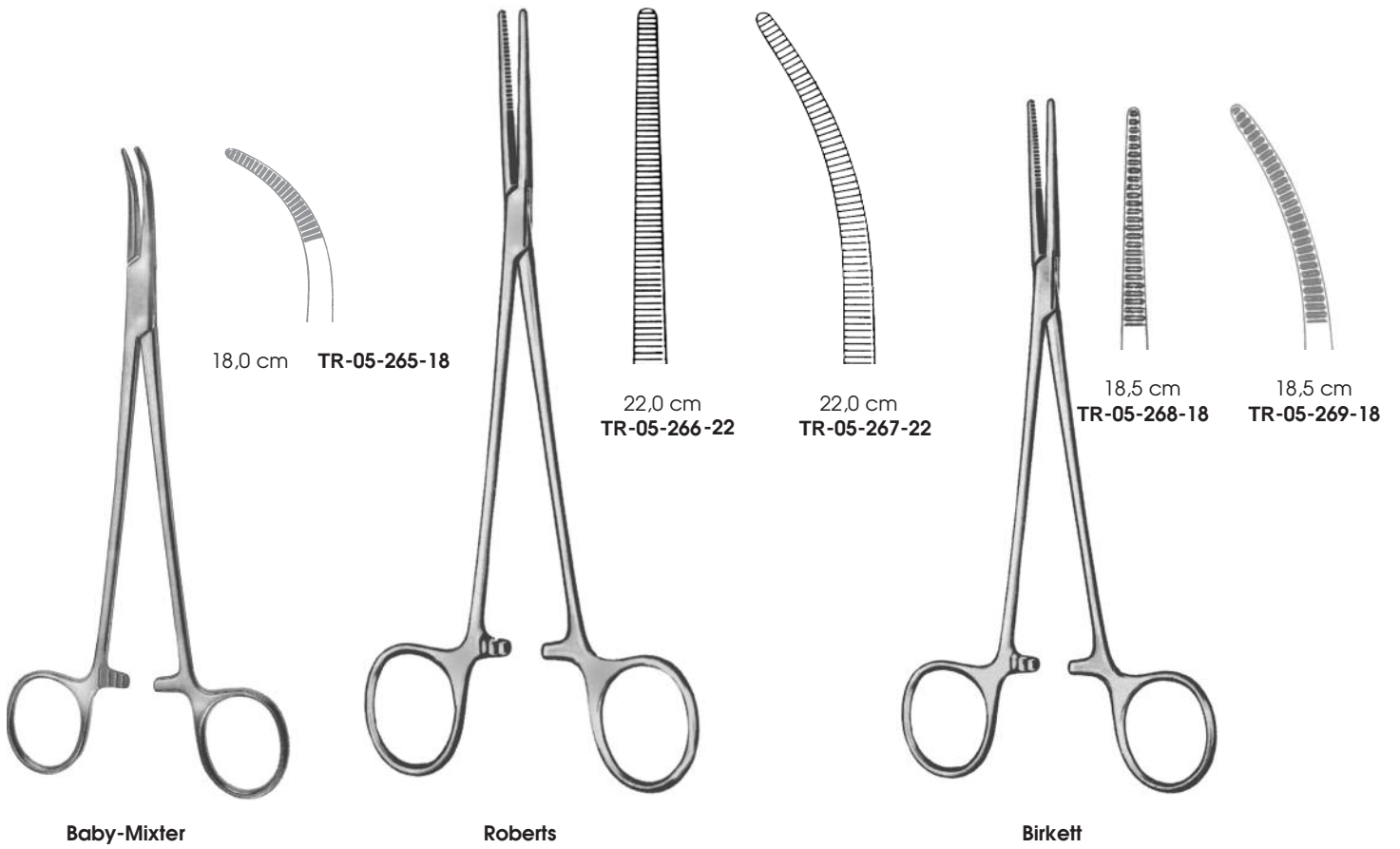

Haemostatic Forceps



Kelly

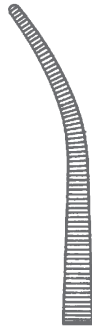

19,0 cm
TR-05-281-19

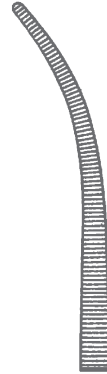

22,0 cm
TR-05-281-22

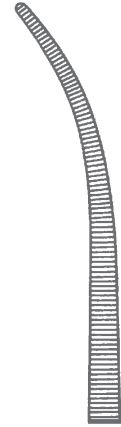

24,0 cm
TR-05-281-24

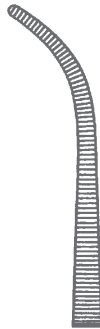

19,0 cm
TR-05-283-19



22,0 cm
TR-05-283-22

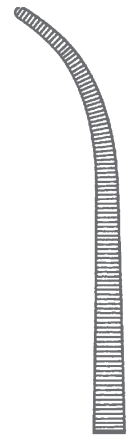

24,0 cm
TR-05-283-24

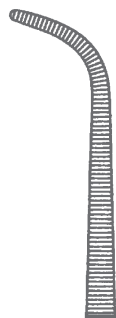

19,0 cm
TR-05-285-19

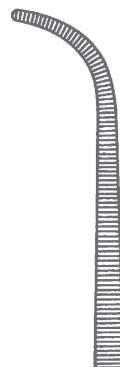

22,0 cm
TR-05-285-22

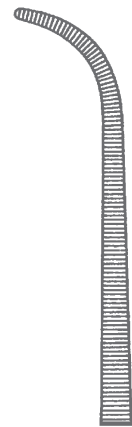

24,0 cm
TR-05-285-24



Wertheim
25,0 cm TR-05-305-25



slightly curved
22,0 cm TR-05-307-22

more curved
23,0 cm TR-05-307-23

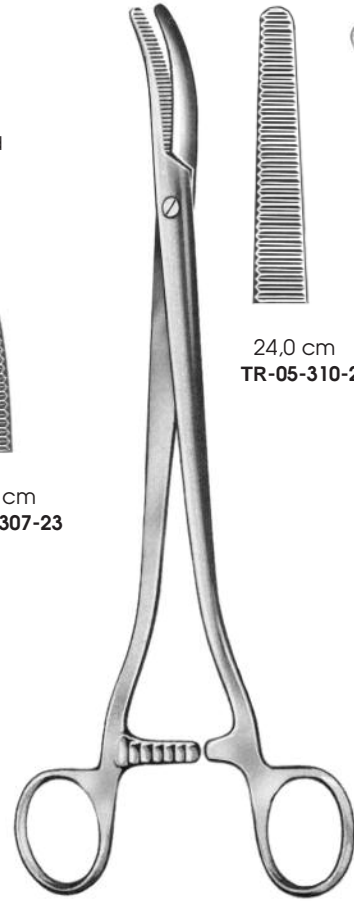

Second-Landau

24,0 cm TR-05-310-24

24,0 cm TR-05-311-24



23,0 cm TR-05-313-23

24,0 cm TR-05-313-24



Moynihan

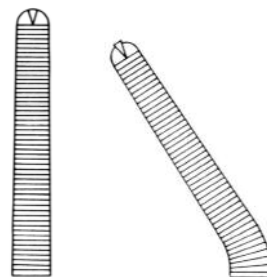

21,5 cm TR-05-314-21

21,0 cm TR-05-315-21

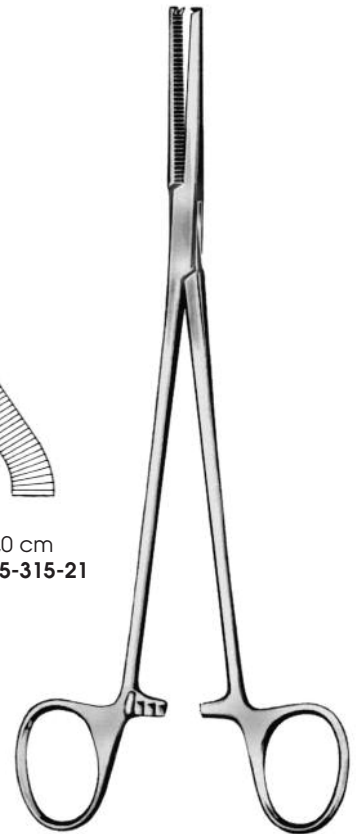

Phaneuf

Hysterectomy Forceps

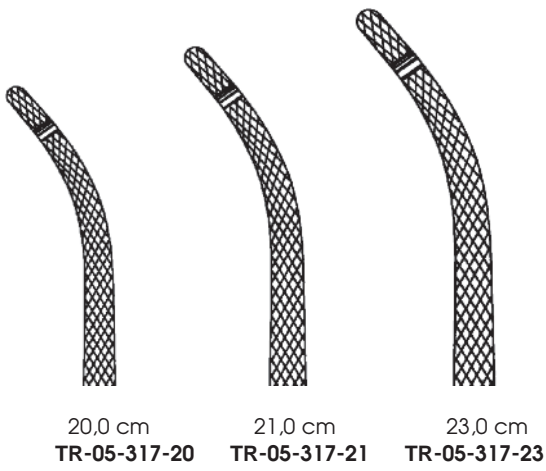

Heaney

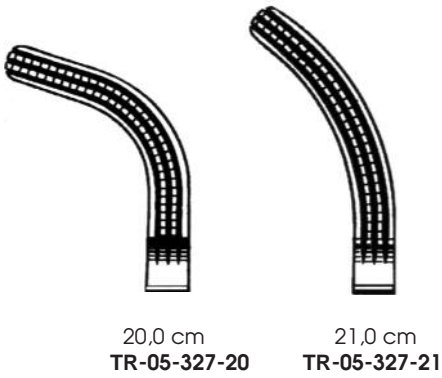
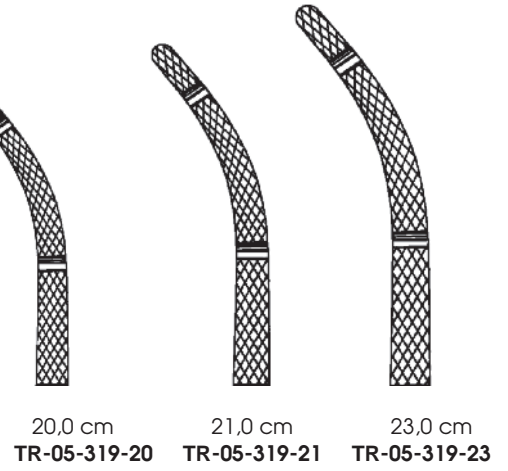

Rogers

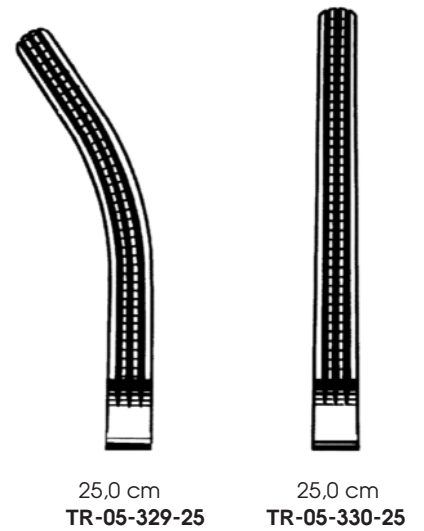
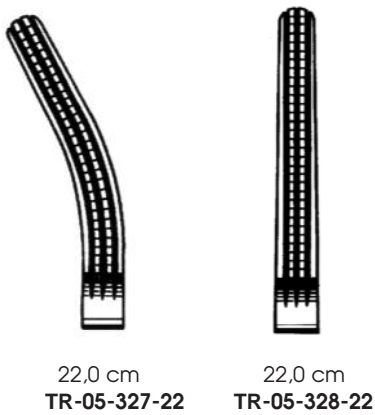
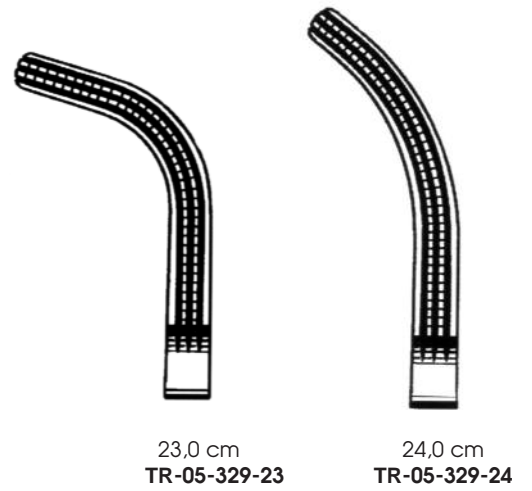



Wertheim
21,0 cm TR-05-335-21

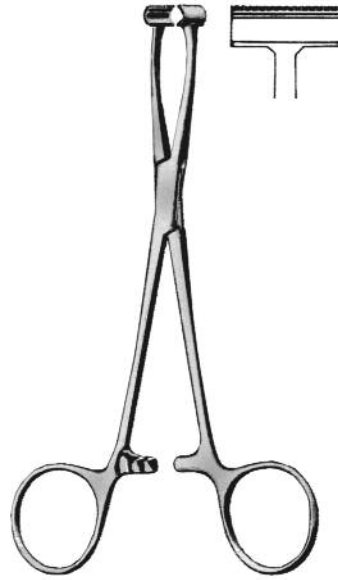

Pratt
15,0 cm TR-05-338-15



Mikulicz
20,5 cm TR-05-339-20



Mikulicz
20,0 cm TR-05-341-20

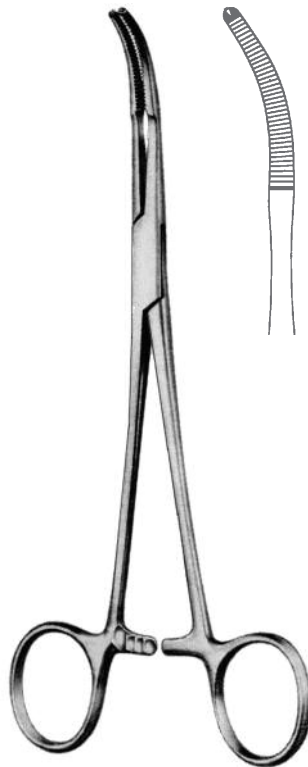

Baby-Mikulicz
14,0 cm TR-05-343-14
18,0 cm TR-05-343-18
20,0 cm TR-05-343-20



Faure

TR-05-345-19 TR-05-345-20

Dissecting Forceps

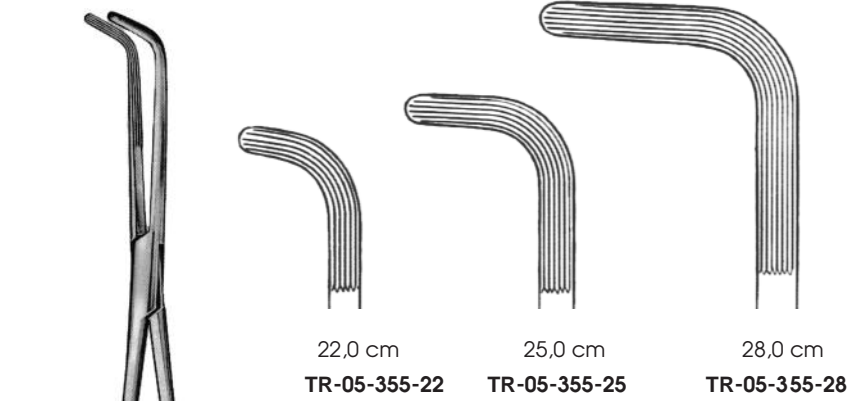

Mixer

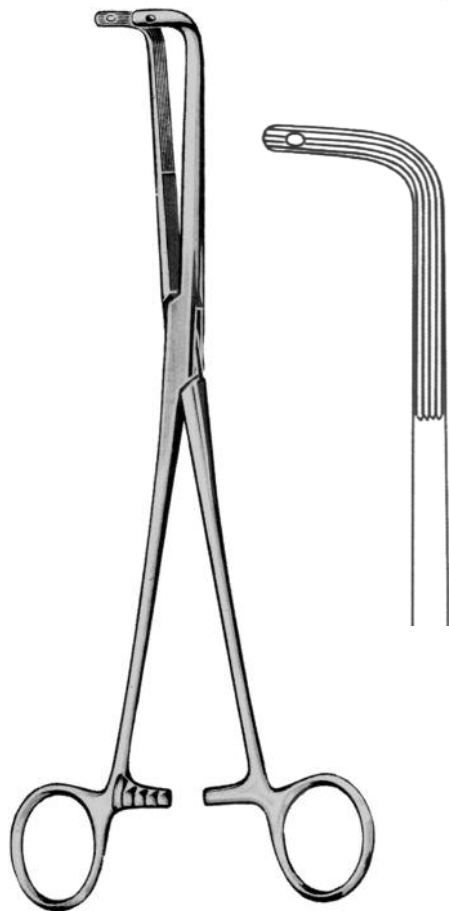

Finochietto
24,0 cm TR-05-357-24

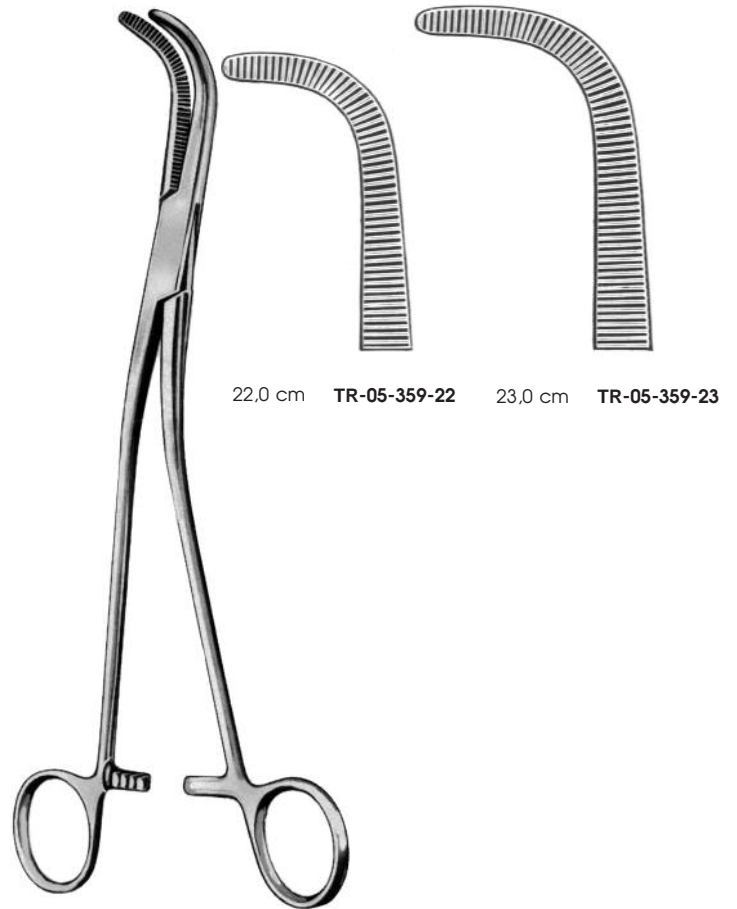

Gray

Dissecting Forceps



19,0 cm
TR-05-361-19



23,0 cm
TR-05-361-23

Lahey



Johns-Hopkins
20,0 cm TR-05-363-20

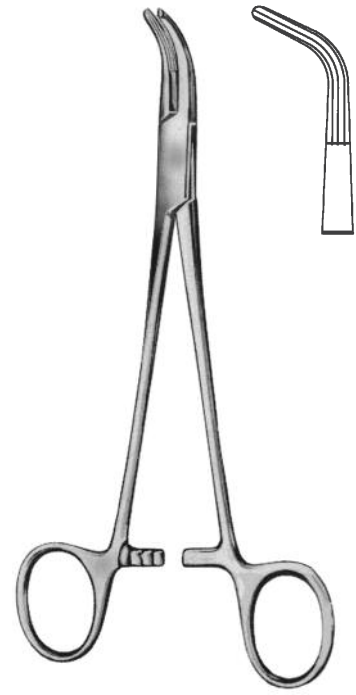

Lower
18,0 cm TR-05-365-18



Mixer-O'Shaughnessy
15,0 cm TR-05-367-15
19,0 cm TR-05-367-19



Desjardins
21,0 cm TR-05-369-21

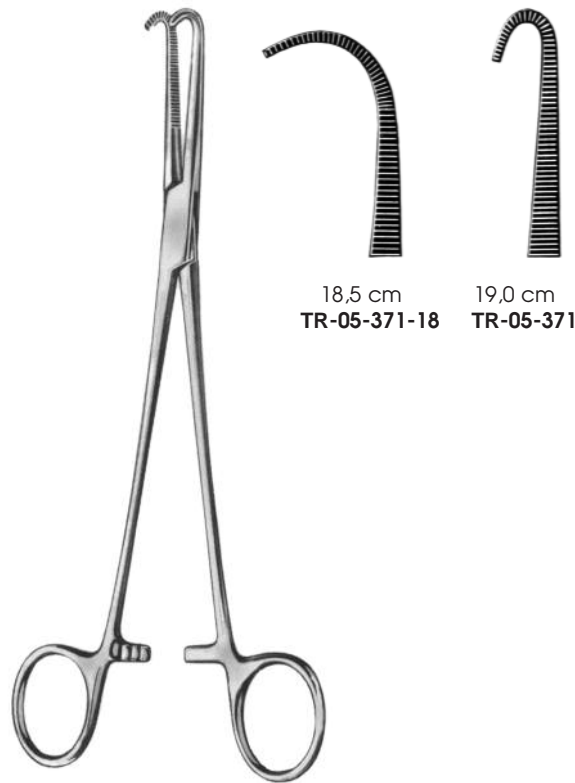

18,5 cm TR-05-371-18
19,0 cm TR-05-371-19

Negus

Kidney Pedicle Forceps



Guyon

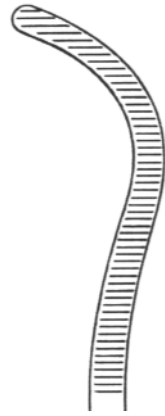

20,0 cm
TR-05-373-20

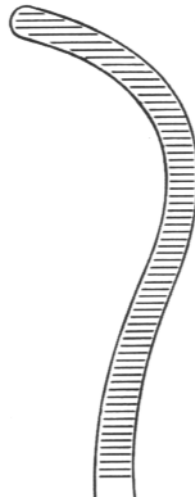

22,0 cm
TR-05-373-22

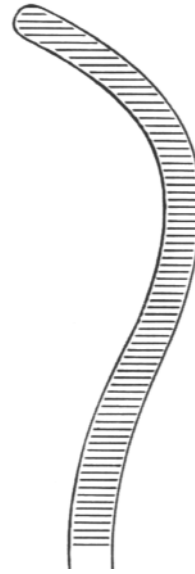

24,0 cm
TR-05-373-24



Guyon

23,0 cm **TR-05-375-23**

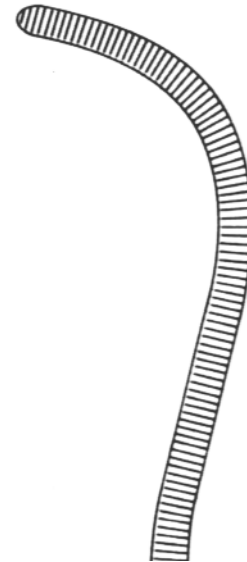

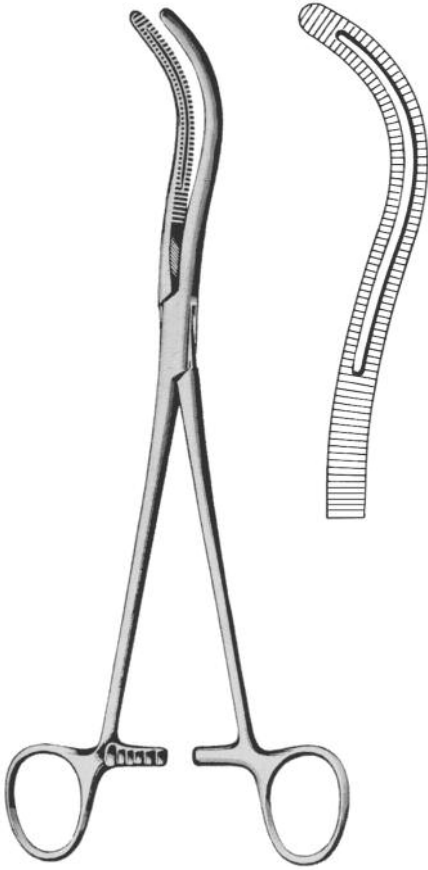

Stille
23,0 cm TR-05-377-23

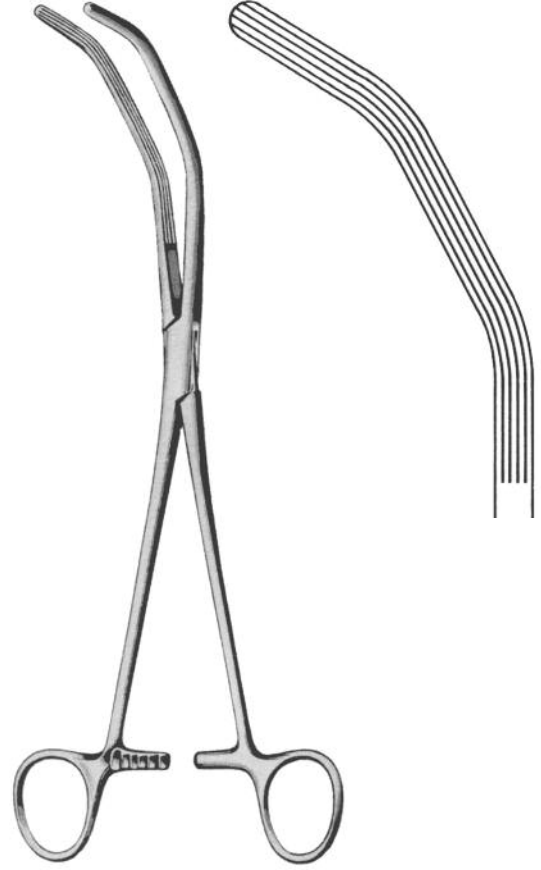

Herrick
23,0 cm TR-05-379-23

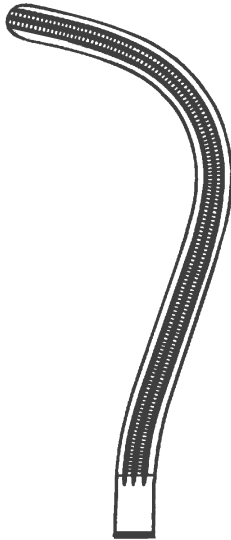

23,0 cm
TR-05-383-23



Guyon



24,0 cm
TR-05-383-24

De Bakey - Atrauma

Bronchus Forceps



Price - Thomas
22,0 cm TR-05-390-22

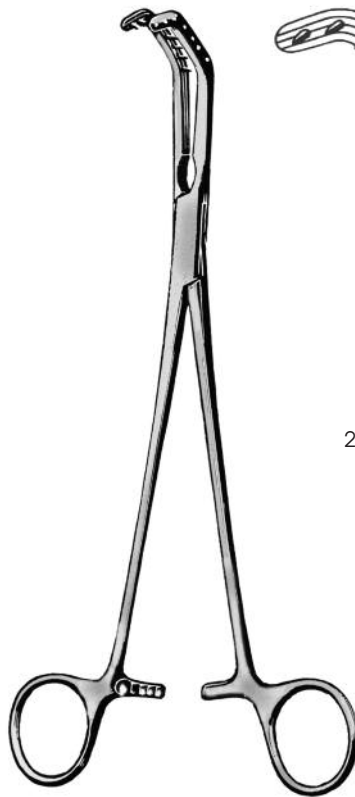
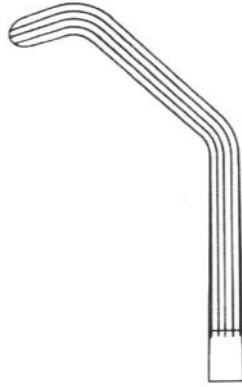

Price - Thomas

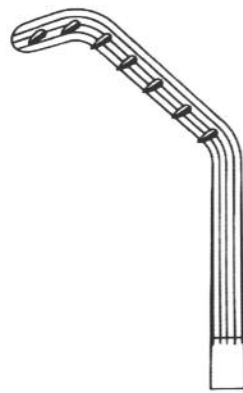

22,0 cm TR-05-391-01

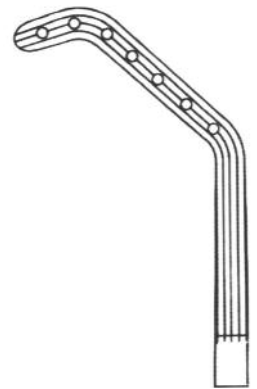

22,0 cm TR-05-391-02



TR-05-490-10
50 mm
10 mm



TR-05-490-14
50 mm
14 mm



TR-05-490-20
60 mm
20 mm



Total length
Length of jaw



TR-05-491-10
50 mm
10 mm



TR-05-491-14
50 mm
14 mm



TR-05-491-20
60 mm
20 mm



Total length
Length of jaw



TR-05-492-50
50 mm
20 mm



TR-05-493-48
50 mm
20 mm



Total length Length of jaw
80 mm 25 mm
90 mm 36 mm
105 mm 50 mm
124 mm 68 mm



TR-05-494-08
TR-05-494-09
TR-05-494-10
TR-05-494-12



TR-05-495-08
TR-05-495-09
TR-05-495-10
TR-05-495-11



Glover

Total length Length of jaw
60 mm 28 mm
70 mm 33 mm
95 mm 50 mm
110 mm 69 mm



TR-05-496-06
TR-05-496-07
TR-05-496-10
TR-05-496-12



TR-05-497-06
TR-05-497-07
TR-05-497-09
TR-05-497-11

Bulldog Clamps

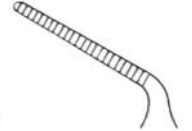
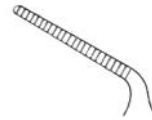
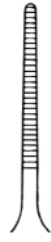
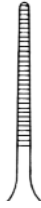
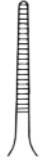

TR-05-498-08	TR-05-498-12	TR-05-498-20	TR-05-498-30
50 mm	50 mm	60 mm	60 mm
8 mm	12 mm	20 mm	30 mm

Diethrich
Total length
Length of jaw

TR-05-499-08	TR-05-499-12	TR-05-499-20	TR-05-499-30
50 mm	50 mm	60 mm	60 mm
8 mm	12 mm	20 mm	30 mm

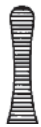

TR-05-500-38	TR-05-500-48	TR-05-502-58
38 mm	48 mm	58 mm
10 mm	15 mm	15 mm

Dieffenbach
Total length
Length of jaw

TR-05-501-38	TR-05-501-48	TR-05-503-58
38 mm	48 mm	58 mm
10 mm	15 mm	15 mm



Johns-Hopkins



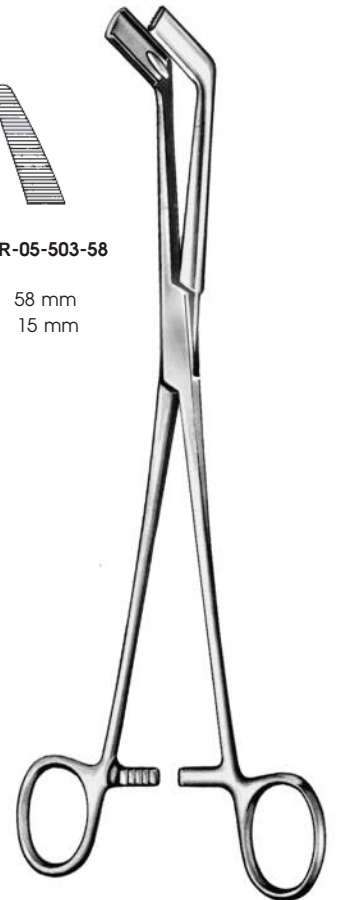











38 mm	TR-05-505-38
48 mm	TR-05-505-48
56 mm	TR-05-505-56
63 mm	TR-05-505-63
70 mm	TR-05-505-70
80 mm	TR-05-505-80
91 mm	TR-05-505-91



Setting Forceps for Bulldog Clamps
24, cm **TR-05-507-24**

Titanium

V = Vein
A = Artery

				
<p>V =</p> <p>A =</p>	<p>30,0 mm</p> <p>TR-05-512-30 TR-05-516-30</p>	<p>35,0 mm</p> <p>TR-05-512-35 TR-05-516-35</p>	<p>40,0 mm</p> <p>TR-05-512-40 TR-05-516-40</p>	<p>50,0 mm</p> <p>TR-05-512-50 TR-05-516-50</p>
				
<p>V =</p> <p>A =</p>	<p>30,0 mm</p> <p>TR-05-513-30 TR-05-517-30</p>	<p>35,0 mm</p> <p>TR-05-513-35 TR-05-517-35</p>	<p>40,0 mm</p> <p>TR-05-513-40 TR-05-517-40</p>	<p>50,0 mm</p> <p>TR-05-513-50 TR-05-517-50</p>
				
<p>V =</p> <p>A =</p>	<p>30,0 mm</p> <p>TR-05-515-30 TR-05-519-30</p>	<p>35,0 mm</p> <p>TR-05-515-35 TR-05-519-35</p>	<p>40,0 mm</p> <p>TR-05-515-40 TR-05-519-40</p>	<p>50,0 mm</p> <p>TR-05-515-50 TR-05-519-50</p>

Bulldog Clamps



Satinsky

70 mm TR-05-525-07



Carotis

90 mm TR-05-527-09



Satinsky

100 mm TR-05-529-10

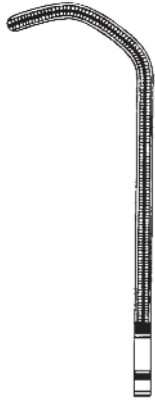

Carotis

50 mm TR-05-531-05

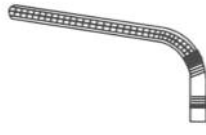

Santulli

70 mm TR-05-533-07

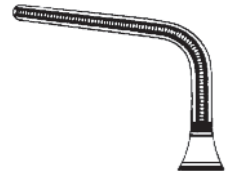

Gregory-Soft

90 mm TR-05-535-09

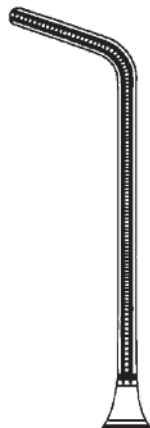

110 mm TR-05-535-11

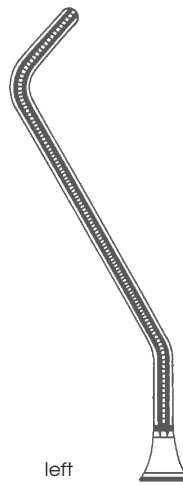

110 mm TR-05-537-01

left



Gregory-Soft

110 mm TR-05-537-02

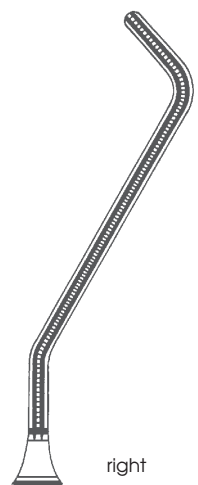

right

Atrauma Forceps

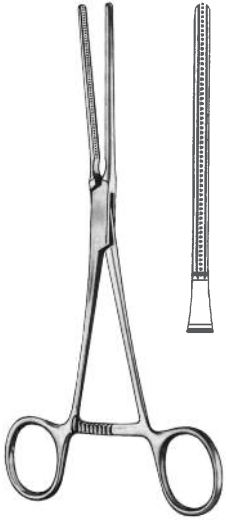

Castaneda
12,0 cm TR-05-540-13



Castaneda

12,0 cm, 30°
TR-05-541-01

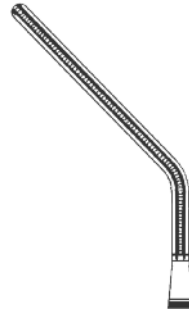

12,0 cm, 45°
TR-05-541-02



11,0 cm, 90°
TR-05-541-03



Castaneda



Fig. 1
15,0 cm TR-05-543-01

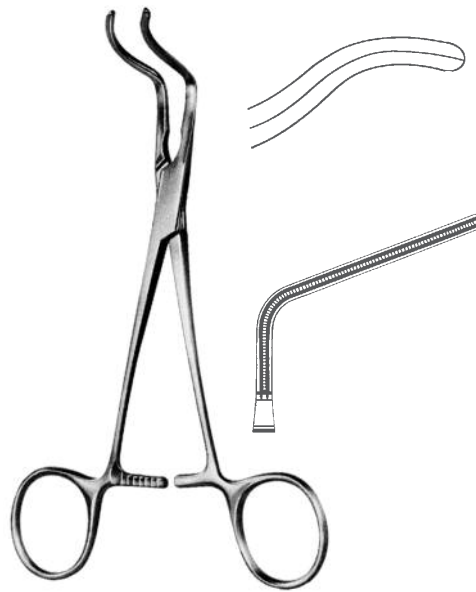

Fig. 2
15,0 cm TR-05-543-02

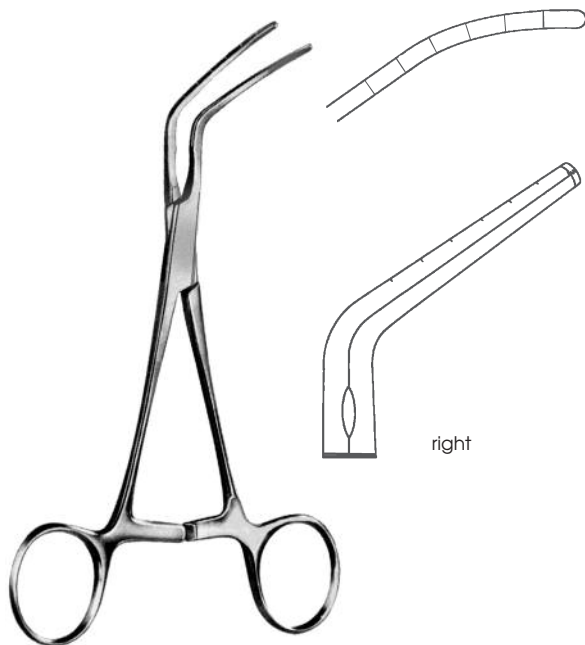

Fig. 3
15,0 cm TR-05-543-03

Atrauma Forceps



Subramanian-Miniature
15,5 cm TR-05-545-15



Subramanian
16,0 cm TR-05-547-16

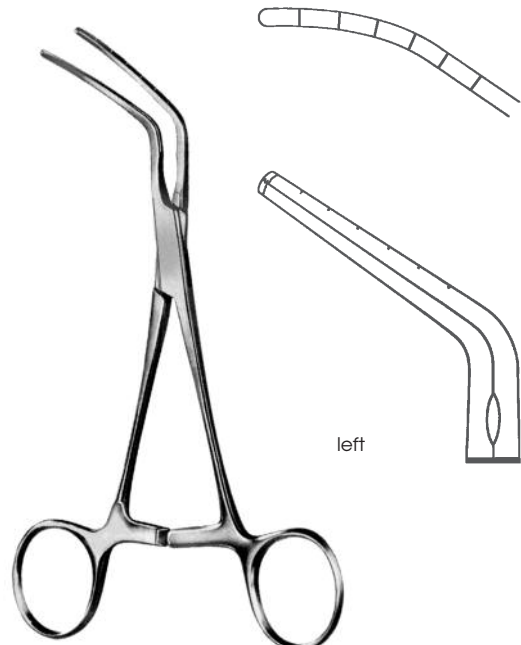

Subramanian
16,0 cm TR-05-549-16

Atrauma Forceps

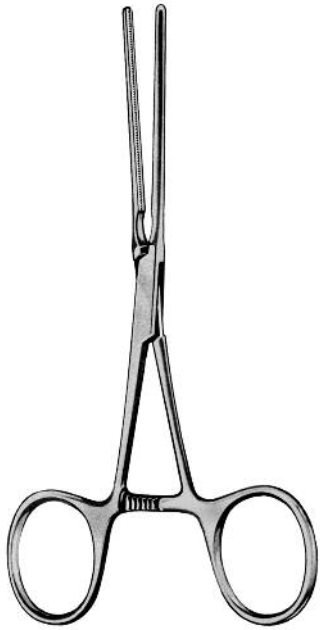

De Bakey



12,0 cm
TR-05-554-12

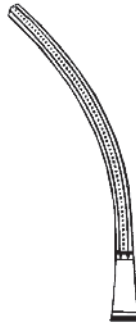

11,0 cm
TR-05-555-11



10,0 cm
TR-05-557-10



De Bakey



s-curved

12,0 cm
TR-05-559-12

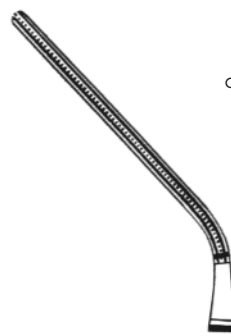

angled

13,0 cm
TR-05-561-13

Atrauma Forceps



De Bakey



17,0 cm
TR-05-562-17



16,0 cm, 30°
TR-05-563-16

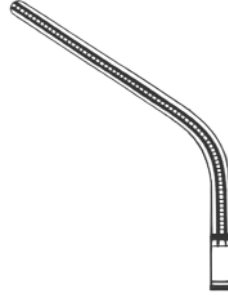

15,0 cm, 60°
TR-05-565-15



15,0 cm, 90°
TR-05-567-15

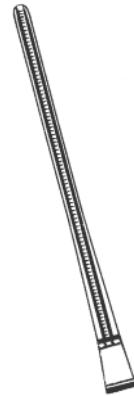

17,0 cm, 15°
TR-05-569-17



17,0 cm
TR-05-571-17



17,0 cm
TR-05-573-17

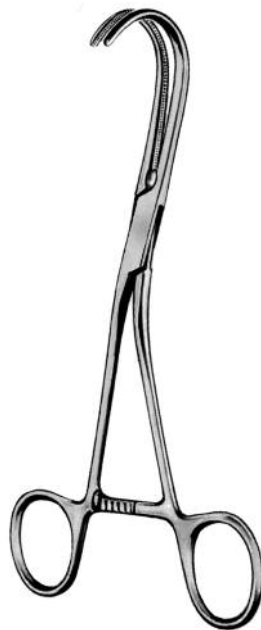

De Bakey

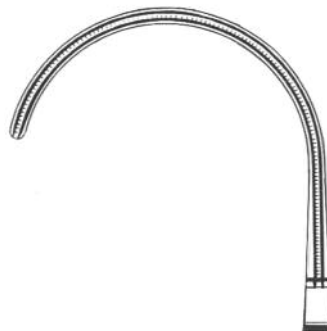

16,0 cm
TR-05-575-16



17,0 cm
TR-05-575-17

Atrauma Forceps



Derra

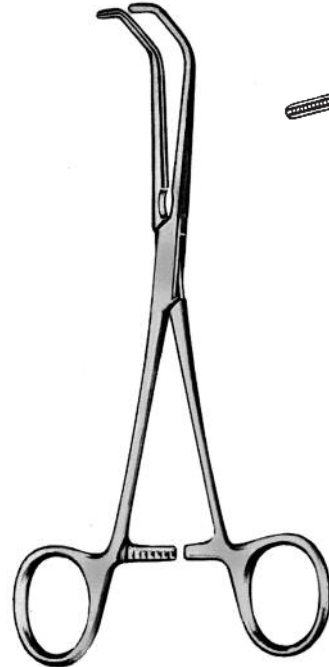
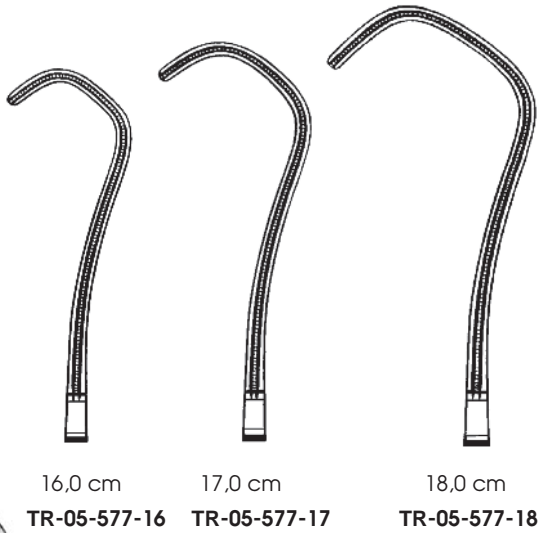

Beck

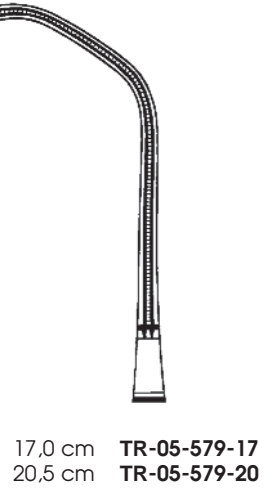

De Bakey-Pean

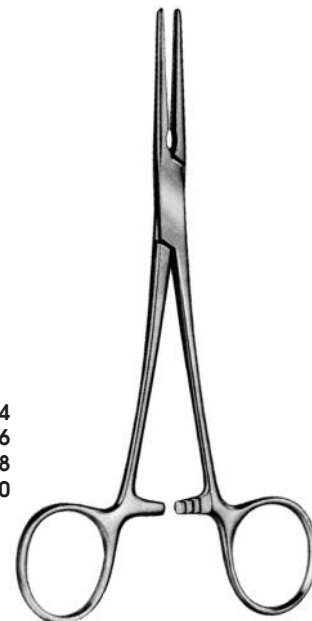
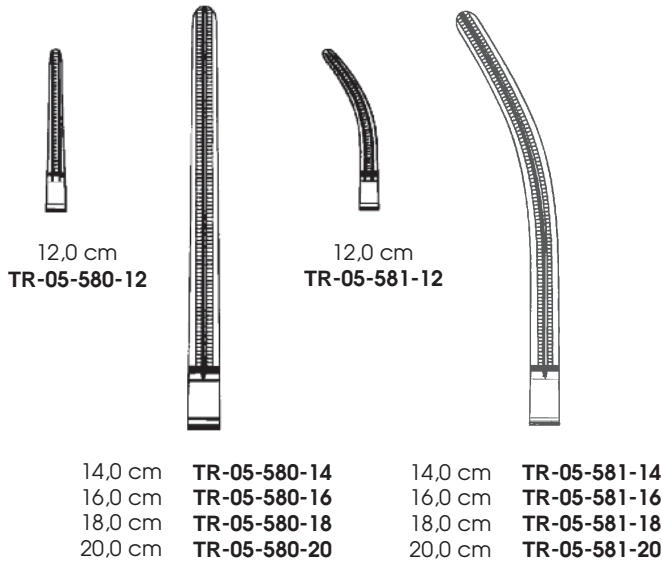

De Bakey



Atrauma Forceps



De Bakey

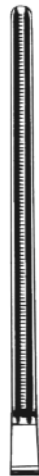

21,5 cm
TR-05-584-21



23,0 cm
TR-05-584-23



27,0 cm
TR-05-584-27



31,5 cm
TR-05-584-31



21,5 cm
TR-05-585-21



23,0 cm
TR-05-585-23



27,0 cm
TR-05-585-27



31,5 cm
TR-05-585-31

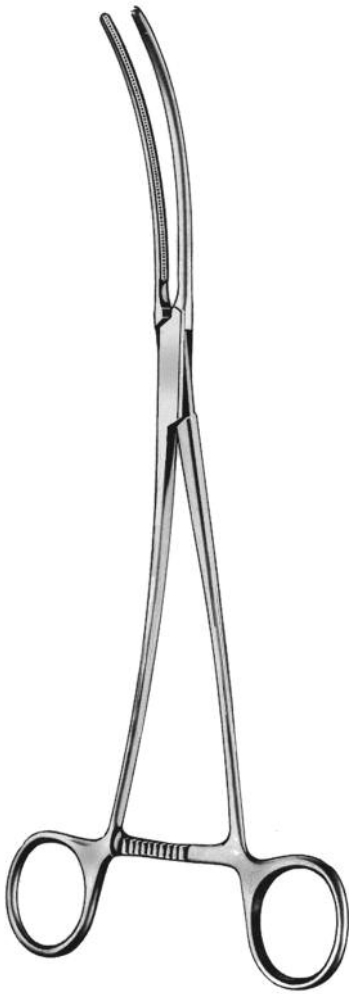

De Bakey

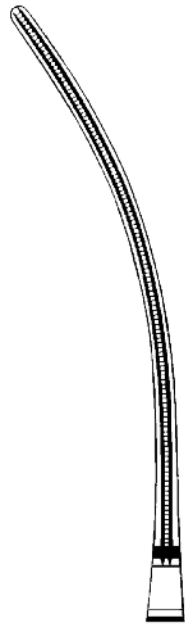

26,0 cm
TR-05-587-26

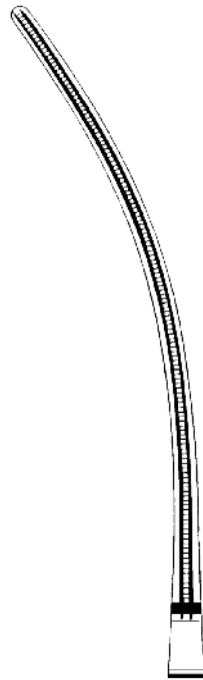

27,0 cm
TR-05-587-27

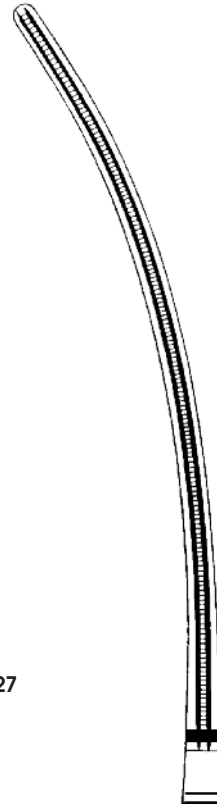

31,0 cm
TR-05-587-31

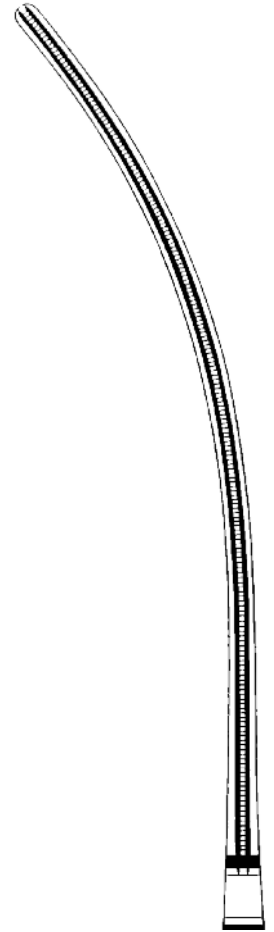

33,0 cm
TR-05-587-33



De Bakey-Bahson

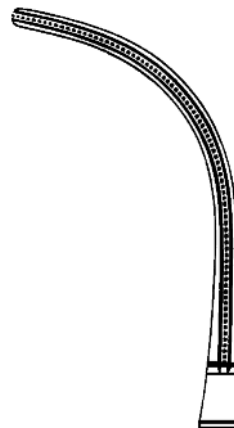

23,0 cm
TR-05-589-23

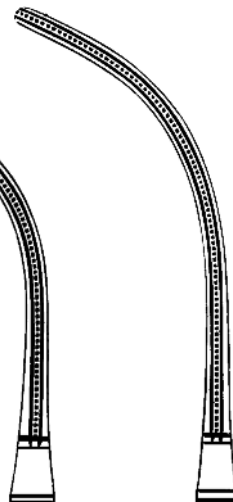

24,0 cm
TR-05-589-24

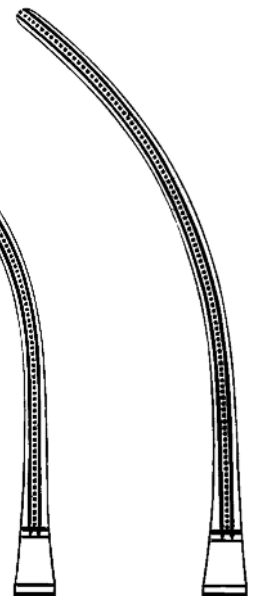

25,0 cm
TR-05-589-25

Atrauma Forceps



De Bakey

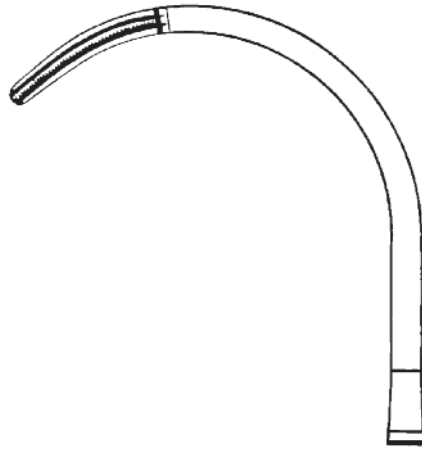

27,0 cm
TR-05-591-25

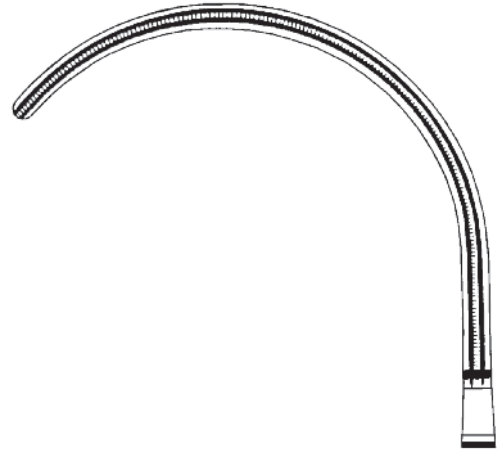

26,0 cm
TR-05-591-26

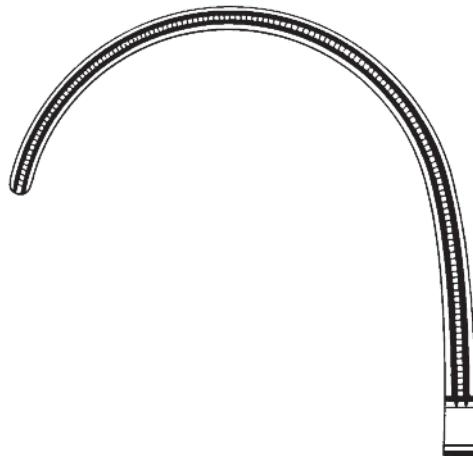

left curved

25,0cm **TR-05-593-**

01 right curved

25,0cm **TR-05-**

593-02



Weber

Atrauma Forceps



De Bakey
28,0 cm TR-05-595-28

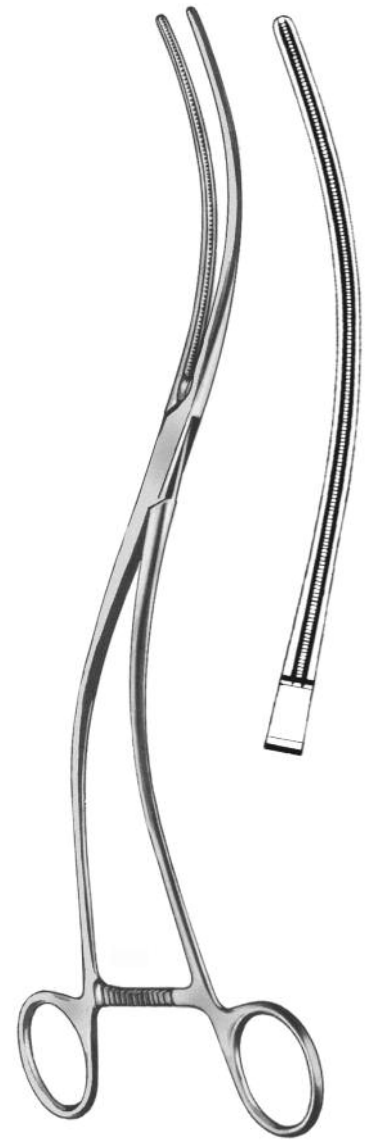

De Bakey
30,0 cm TR-05-595-30



Brainbridge



15,0 cm
TR-05-596-15



18,0 cm
TR-05-596-18



15,0 cm
TR-05-597-15

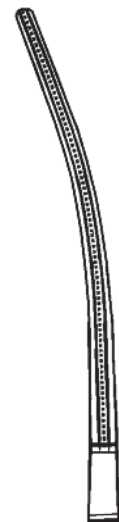

18,0 cm
TR-05-597-18

Atrauma Forceps



De Bakey
20,0 cm TR-05-599-20



Lees
24,5 cm TR-05-599-24



Glover

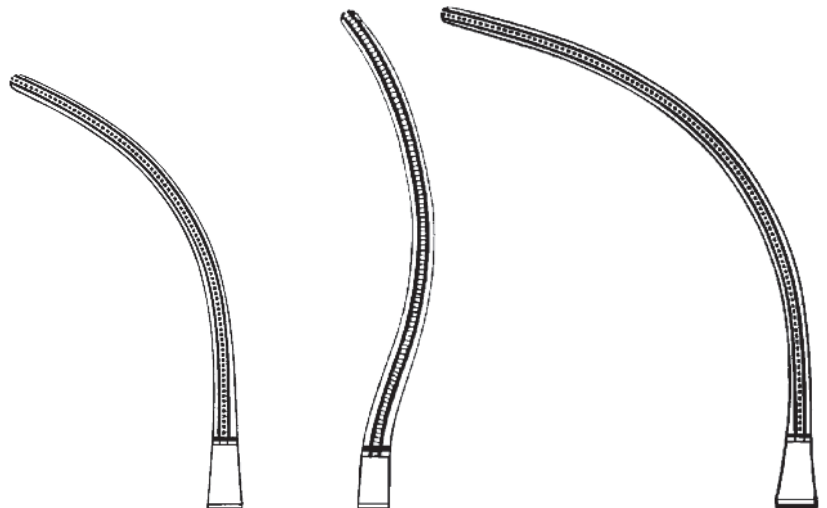

22,0 cm
TR-05-601-22

22,5 cm
TR-05-601-23

24,5 cm
TR-05-601-24

Atrauma Forceps



De Bakey



19,0 cm
TR-05-605-19

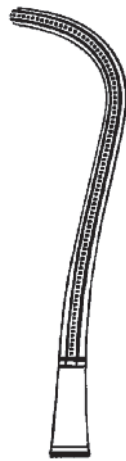

23,0 cm
TR-05-605-23



De Bakey

16,0 cm **TR-05-607-16**

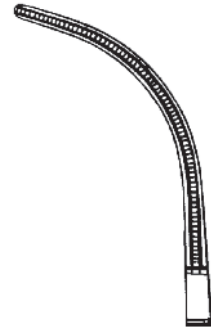

De Bakey

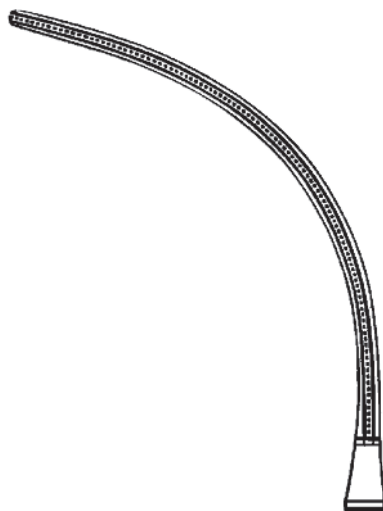

19,0 cm
TR-05-609-19

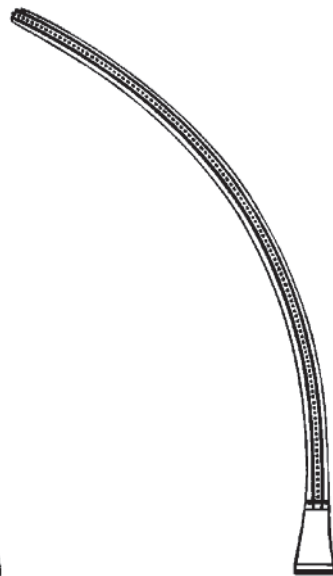

20,0 cm
TR-05-609-20

Atrauma Forceps

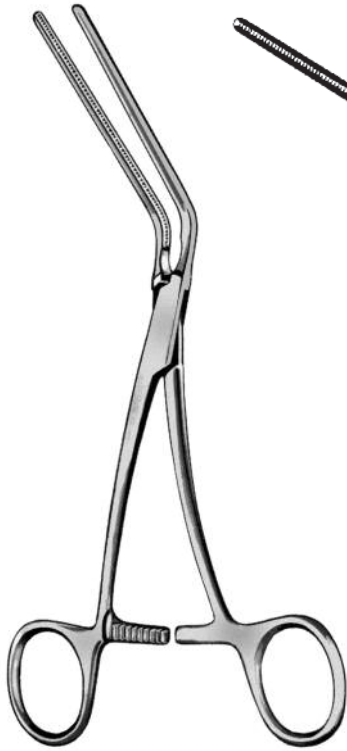

Leland

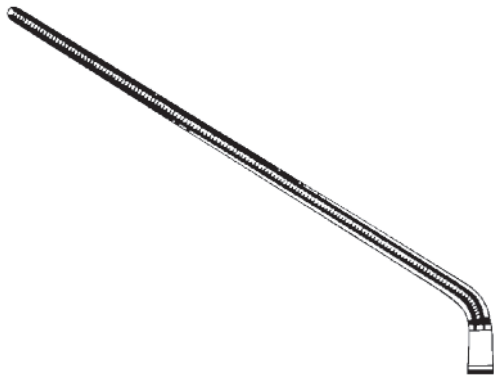

18,0 cm
TR-05-611-18

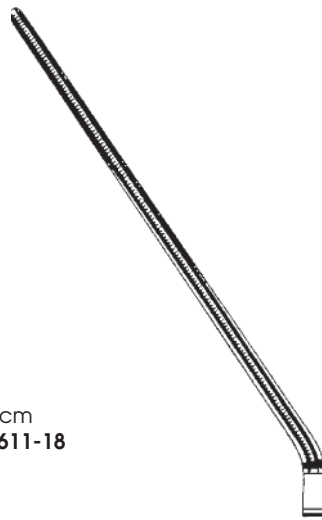

19,0 cm
TR-05-611-19



20,0 cm
TR-05-611-20



21,0 cm
TR-05-612-21



22,0 cm
TR-05-612-22



24,0 cm
TR-05-612-24



De Bakey

Atrauma Forceps



De Bakey



21,0 cm
TR-05-613-21



22,0 cm
TR-05-613-22

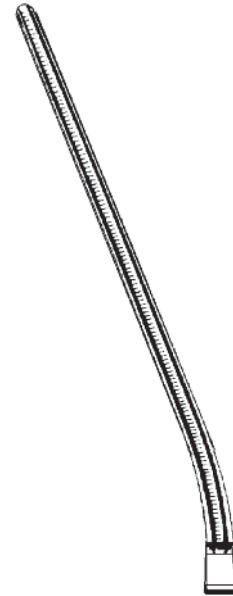

24,0 cm
TR-05-613-24



21,0 cm
TR-05-615-21



22,0 cm
TR-05-615-22



De Bakey

Atrauma Forceps



De Bakey

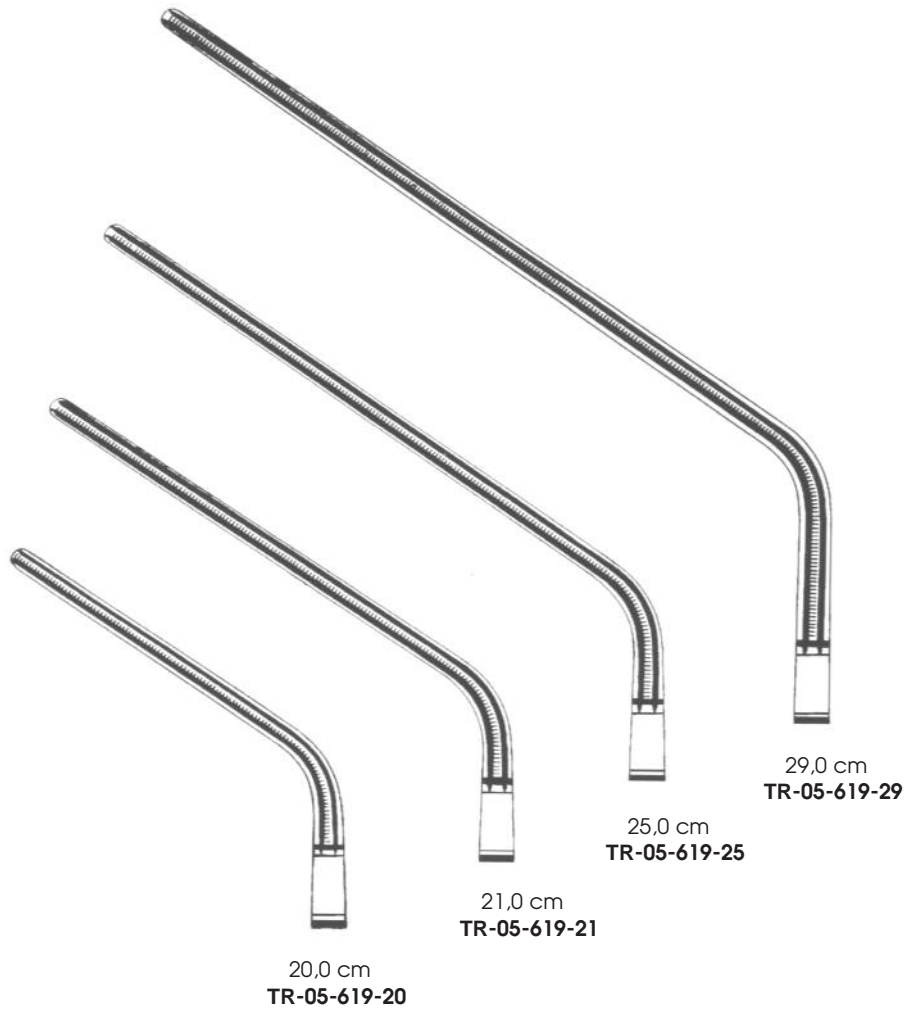
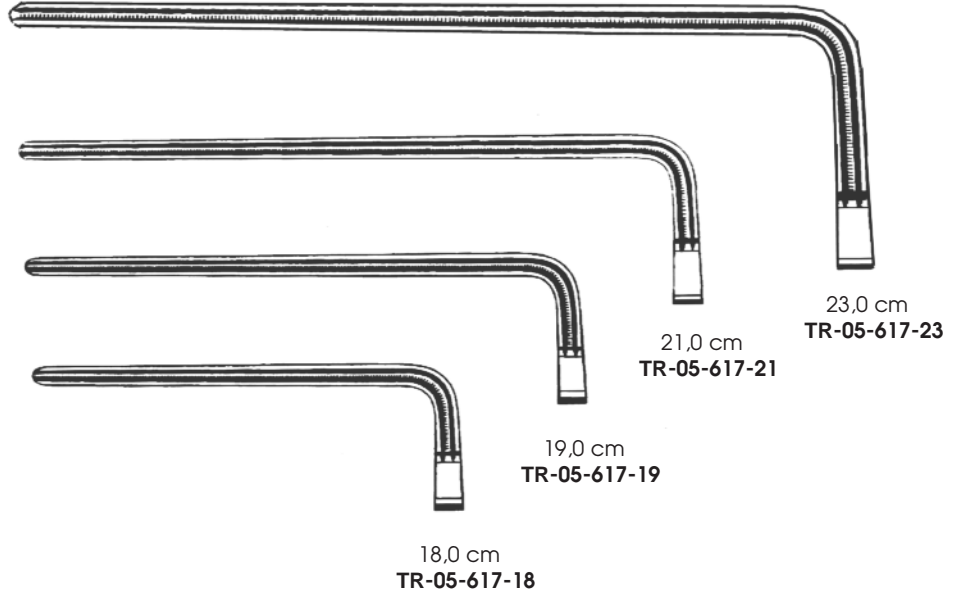



Lees

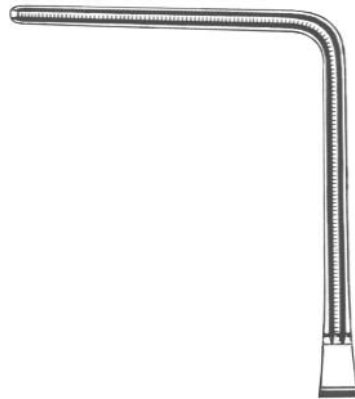

23,0 cm
TR-05-621-23

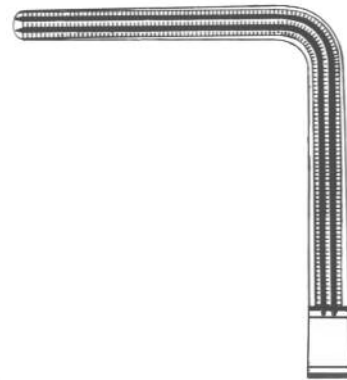

25,0 cm
TR-05-621-25



Lees

25,0 cm **TR-05-623-25**

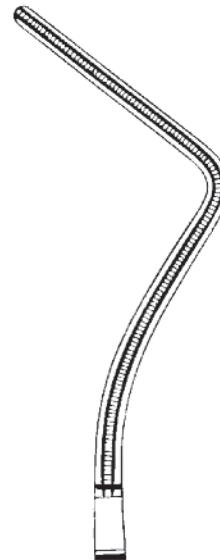

Atrauma Forceps



Morris-De Bakey

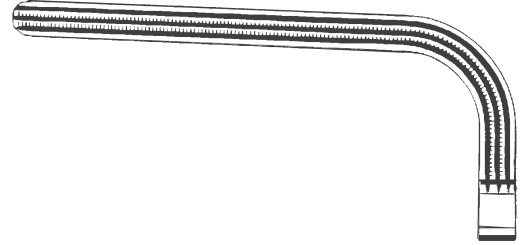

18,0 cm
TR-05-625-01

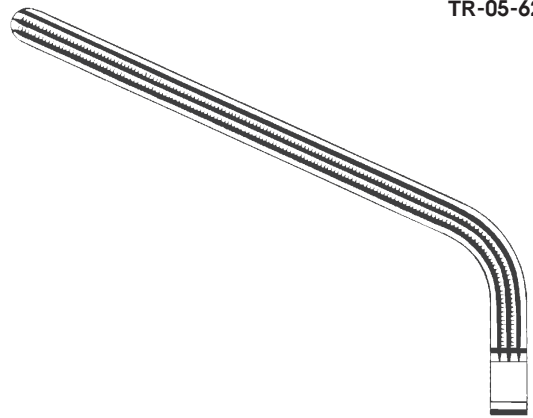

20,0 cm
TR-05-625-03

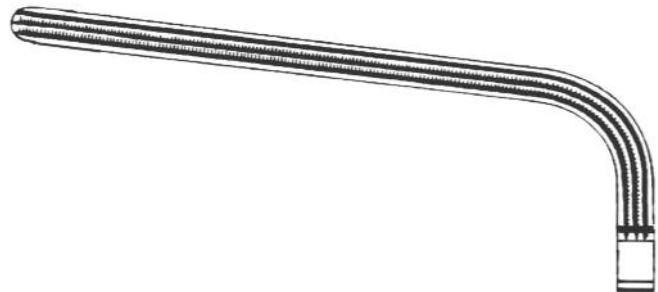

23,0 cm
TR-05-625-04

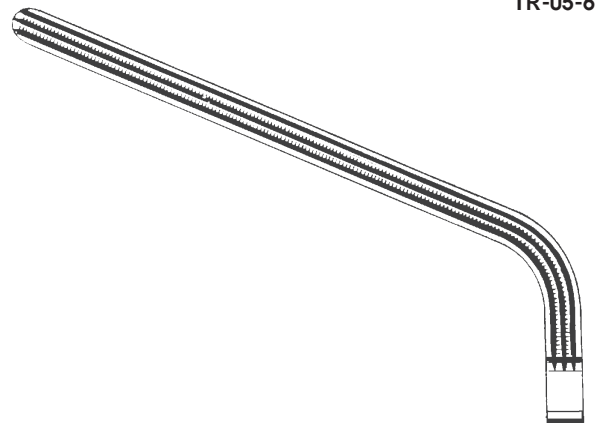

24,0 cm
TR-05-625-05

Atrauma Forceps



De Bakey
27,0 cm TR-05-627-27

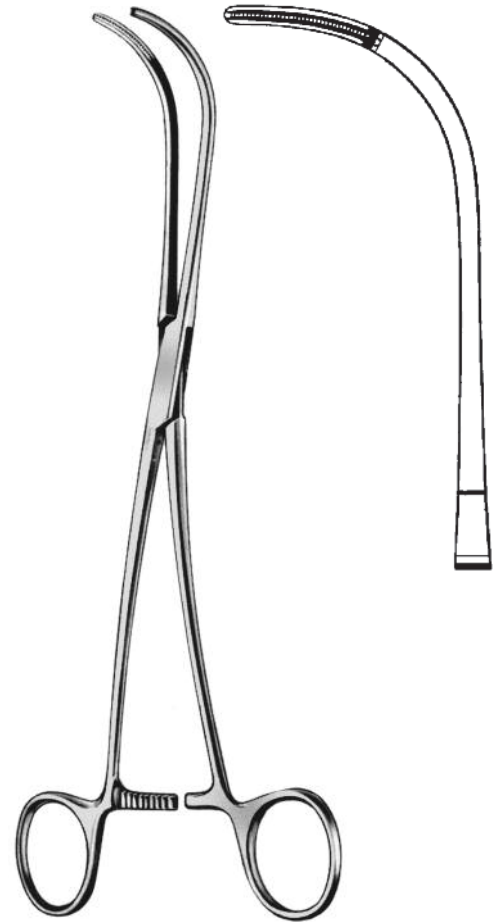
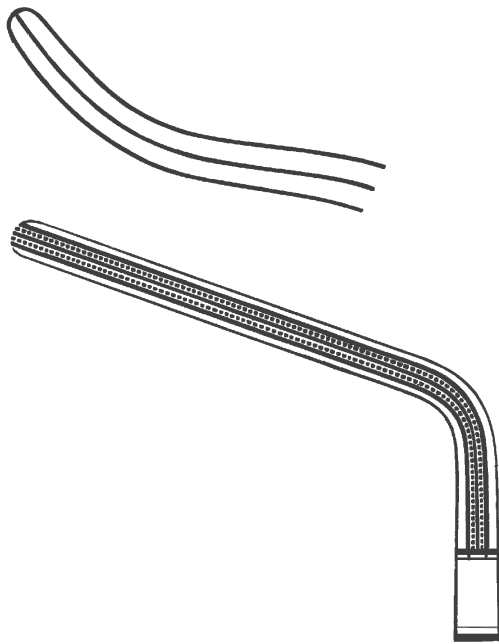

De Bakey
24,0 cm TR-05-629-24

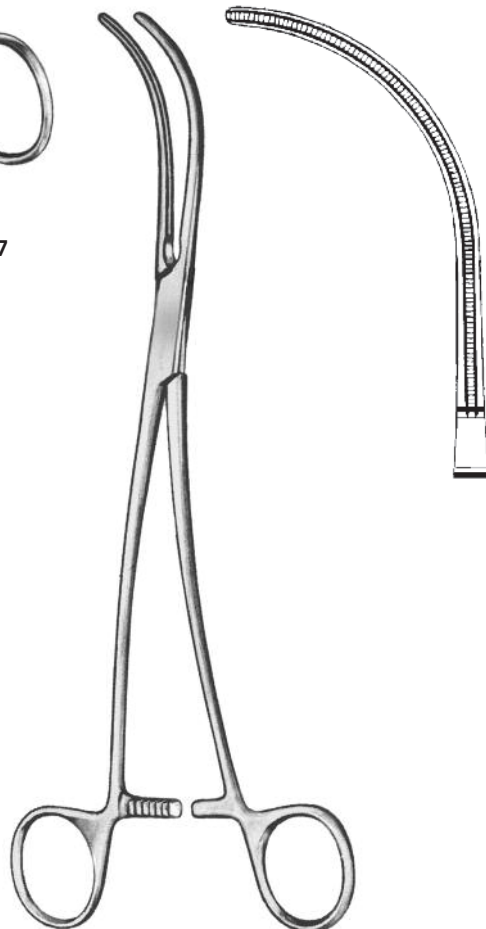

De Bakey
24,0 cm TR-05-631-24

Atrauma Forceps

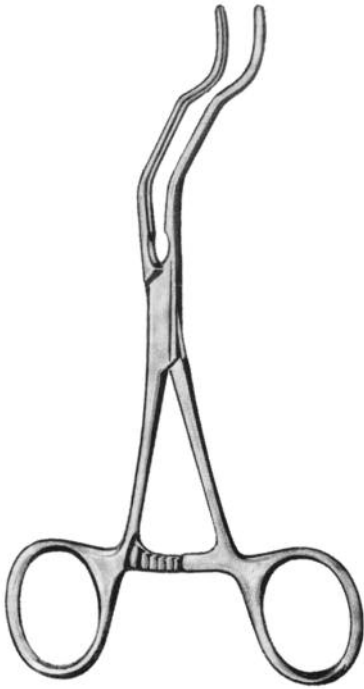

Gregory

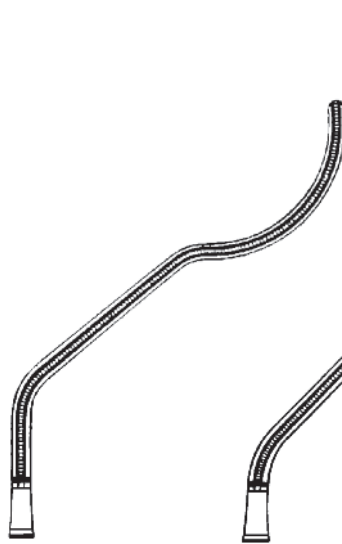

14,0 cm
TR-05-633-14



16,0 cm
TR-05-633-16

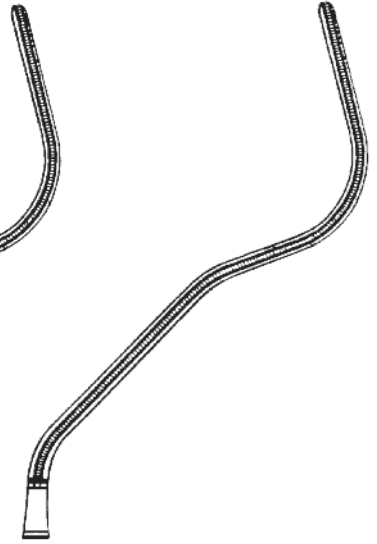

18,0 cm
TR-05-633-18

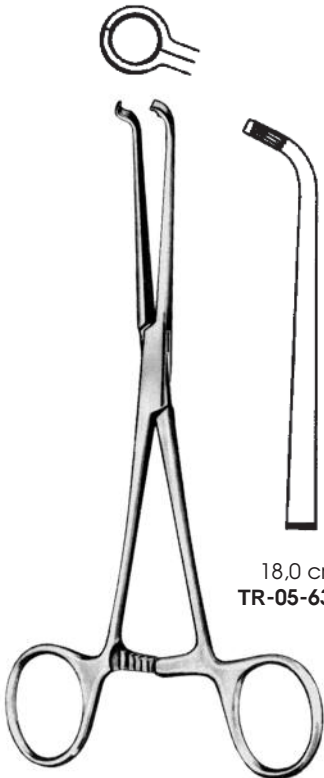

Javid



18,0 cm
TR-05-635-18

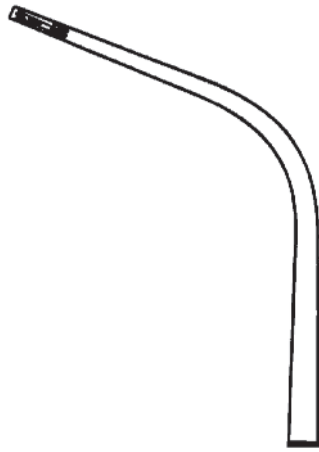

19,0 cm
TR-05-635-19

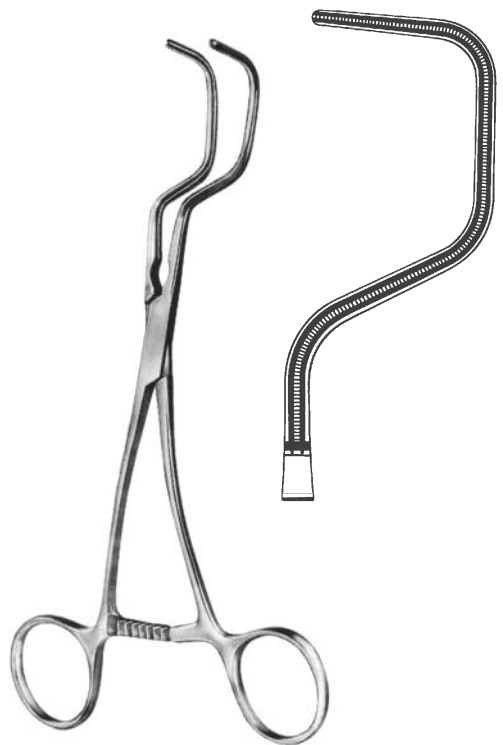

Dale

18,0 cm **TR-05-639-18**

Atrauma Forceps



Dale



17,0 cm
TR-05-641-17



18,0 cm
TR-05-641-18

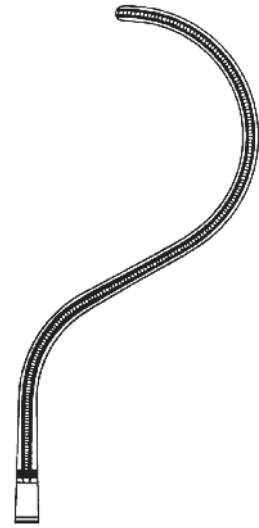

19,0 cm
TR-05-641-19

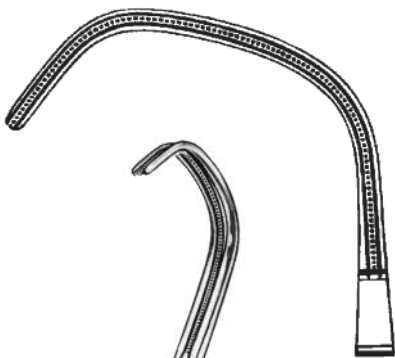

21,0 cm
TR-05-643-21

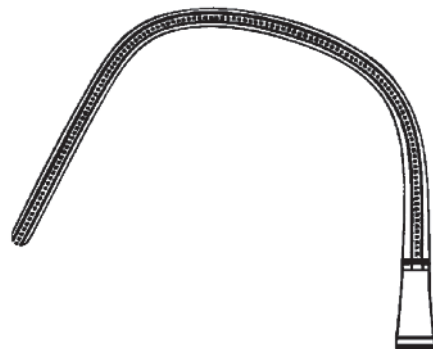

22,0 cm
TR-05-643-22

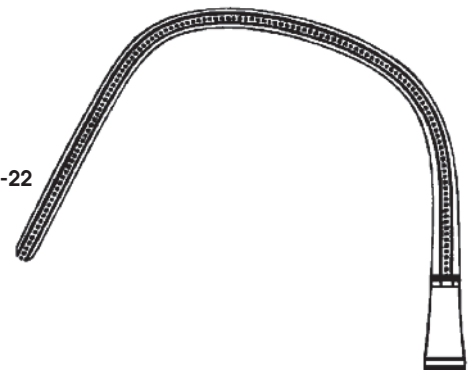

25,0 cm
TR-05-643-25



Lambert-Kay

Atrauma Forceps



17,0 cm TR-05-645-17

De Bakey



20,0 cm TR-05-645-20

Cooley-De Bakey



Satinsky

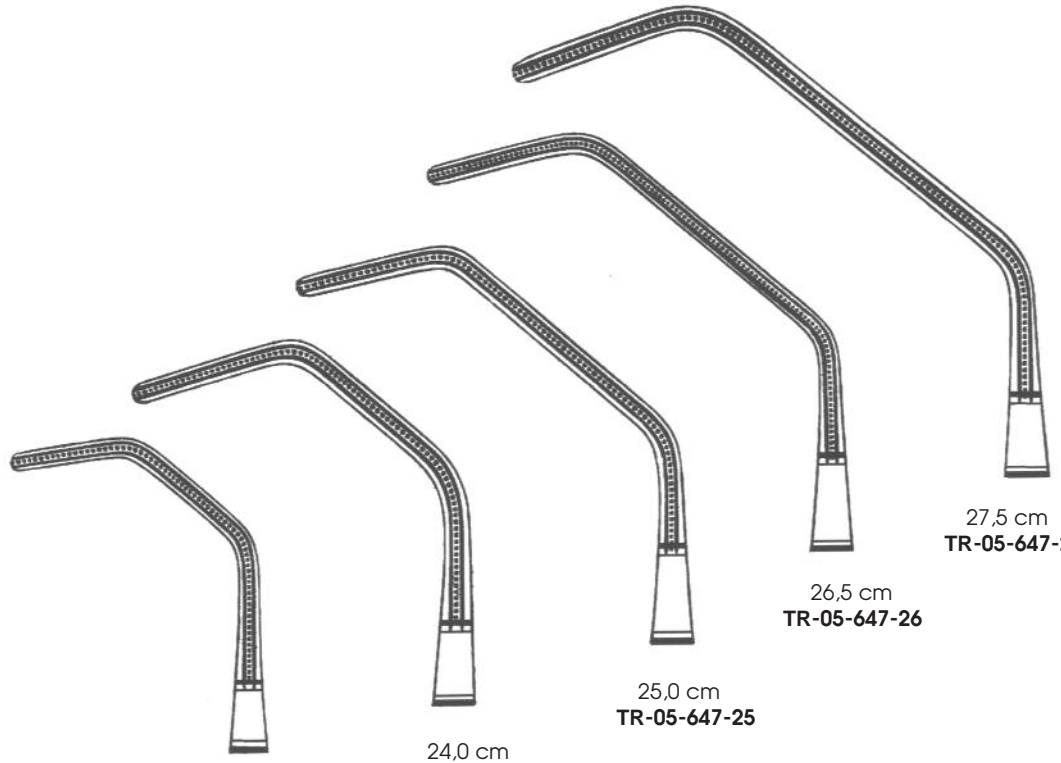

20,5 cm
TR-05-647-20

24,0 cm
TR-05-647-24

25,0 cm
TR-05-647-25

26,5 cm
TR-05-647-26

27,5 cm
TR-05-647-27

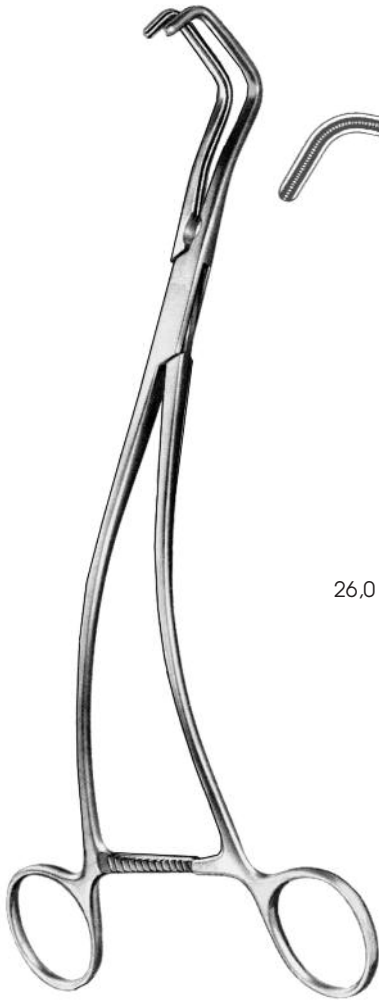

De Bakey

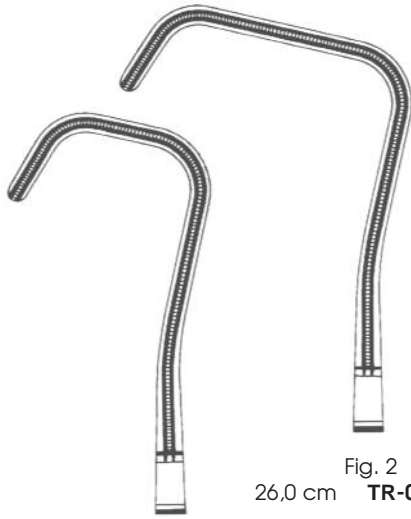
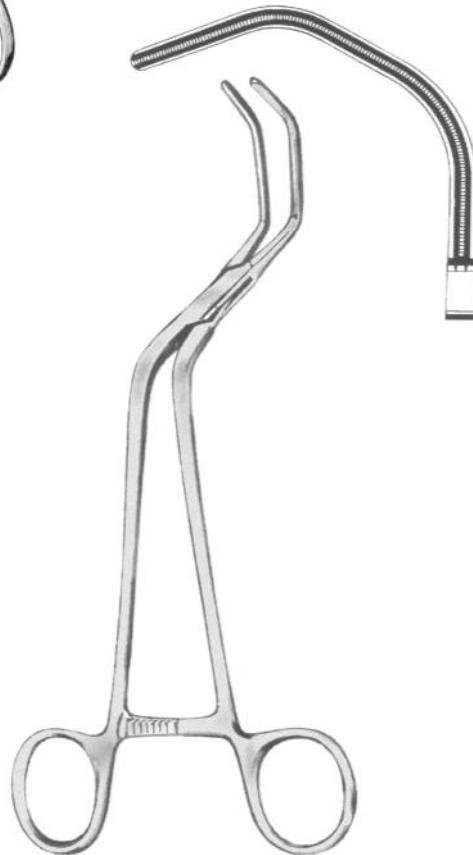

Fig. 1
26,0 cm **TR-05-648-01**

Fig. 2
26,0 cm **TR-05-648-02**



Ochsner
23,5 cm **TR-05-649-23**



Diethrich
21,5 cm **TR-05-651-21**

Atrauma Forceps

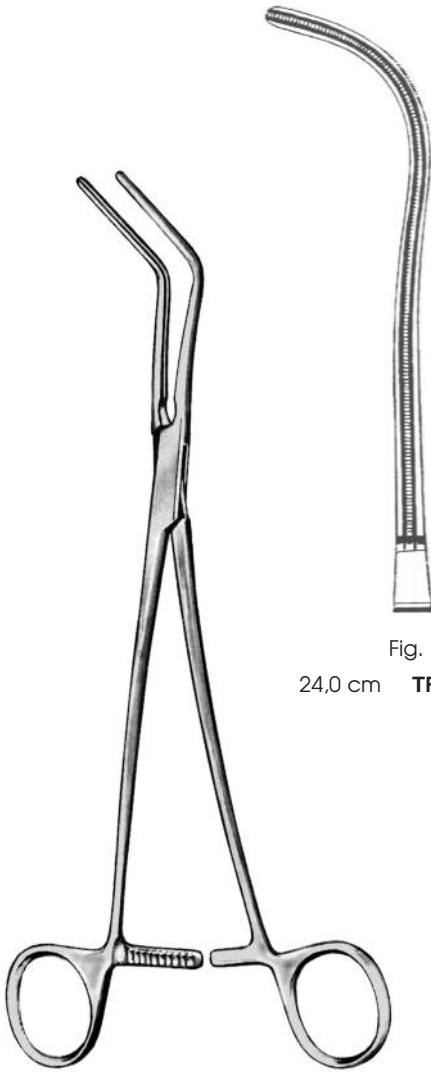

Harken



Fig. 1
24,0 cm **TR-05-653-01**



Fig. 2
24,0 cm **TR-05-653-02**

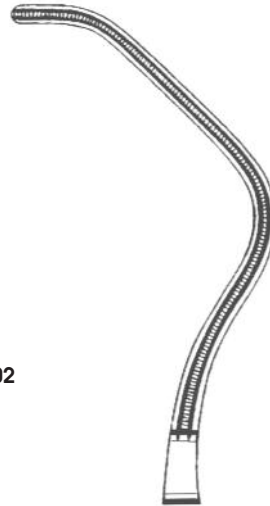

Fig. 3
24,0 cm **TR-05-653-03**

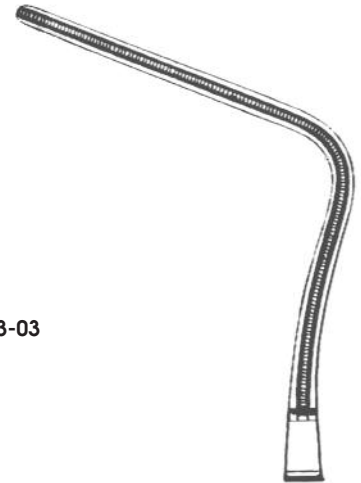
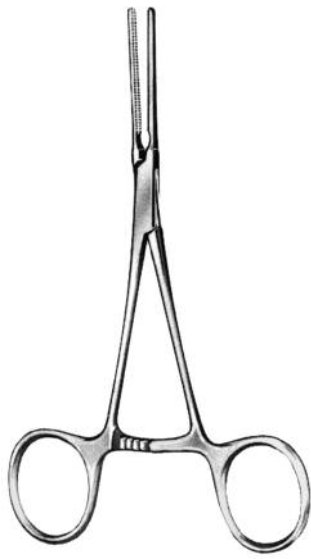

Fig. 4
24,0 cm **TR-05-653-04**



Cooley

14,0 cm



TR-05-654-01



TR-05-654-02



TR-05-654-03

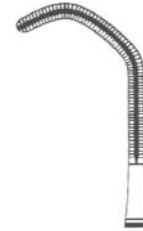

TR-05-654-04



TR-05-654-05



Fig. 1

TR-05-656-01



Fig. 2

TR-05-656-02



Fig. 3

TR-05-656-03

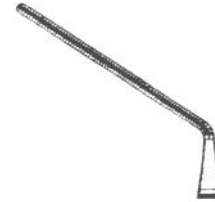

Fig.4

TR-05-656-04



Fig. 5

TR-05-656-05

straight
angled
curved

TR-05-657-01

TR-05-657-02

TR-05-657-03

TR-05-657-04

TR-05-657-05

TR-05-659-01

TR-05-659-02

TR-05-659-03

TR-05-659-04

TR-05-659-05

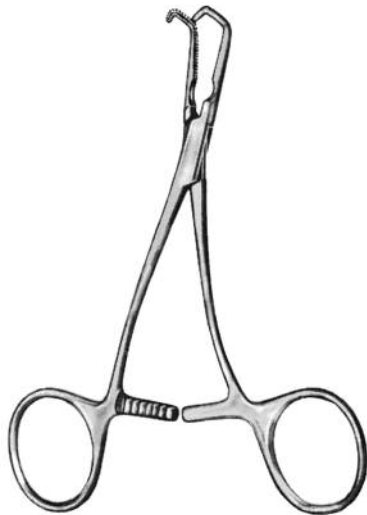

Cooley



straight



angled



curved



Fig. 6

TR-05-656-06

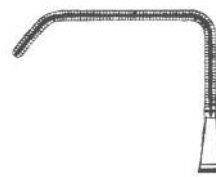

Fig. 7

TR-05-656-07



Fig. 8

TR-05-656-08



Fig. 9

TR-05-656-09

14,0 cm

straight

angled

curved

TR-05-657-06

TR-05-657-07

TR-05-657-08

TR-05-657-09

TR-05-659-06

TR-05-659-07

TR-05-659-08

TR-05-659-09

Atrauma Forceps



Cooley

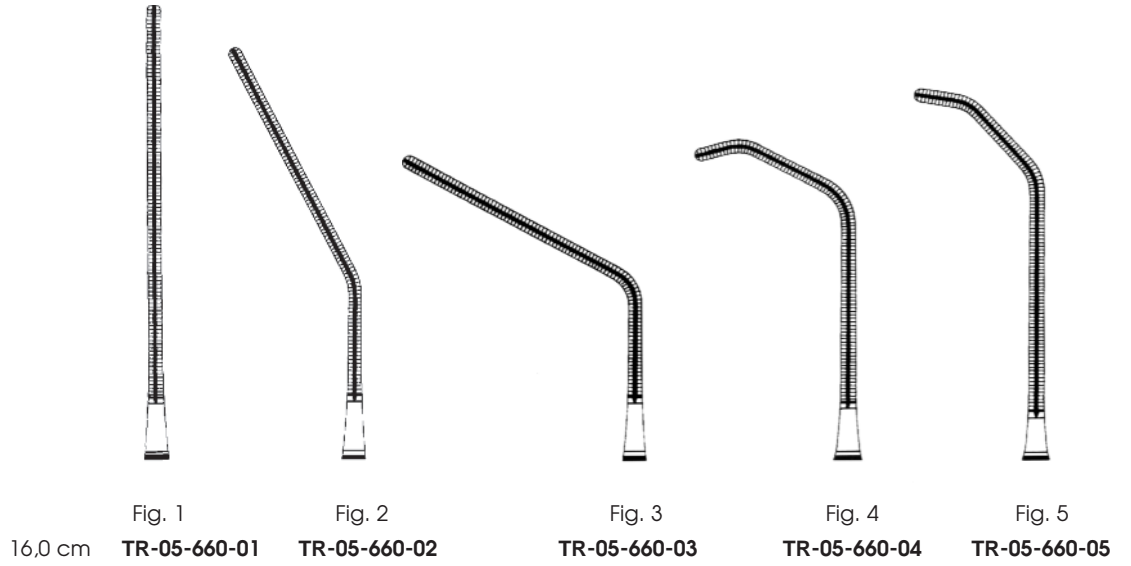

Cooley

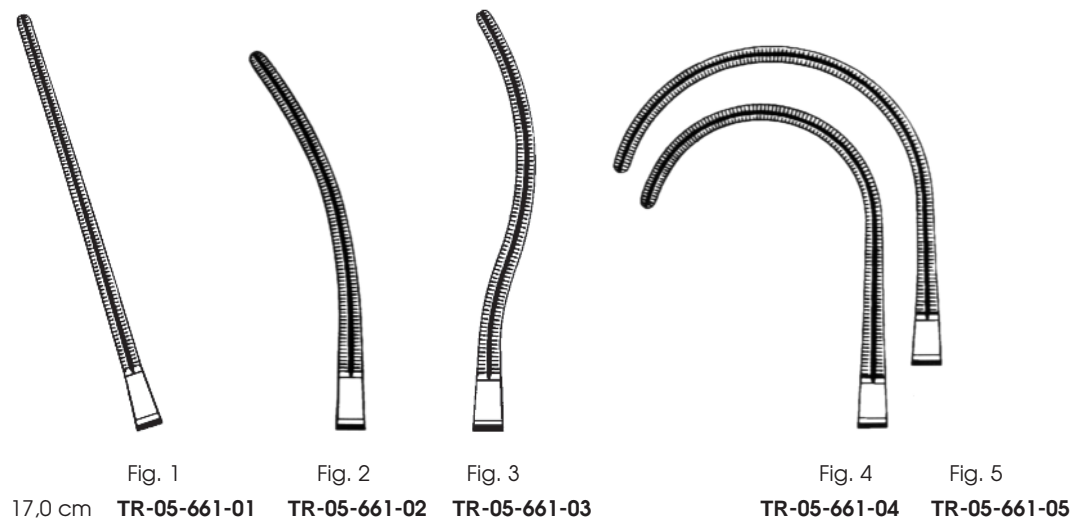

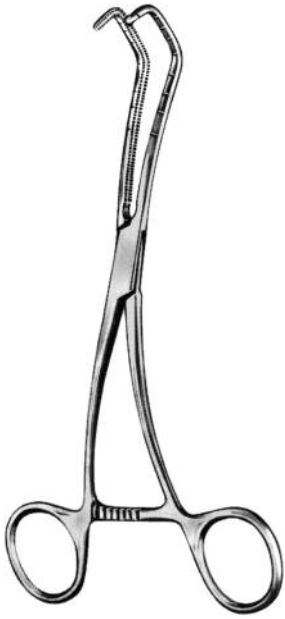

Cooley-Derra



17,0 cm TR-05-663-16



17,0 cm TR-05-663-17



17,0 cm TR-05-663-18

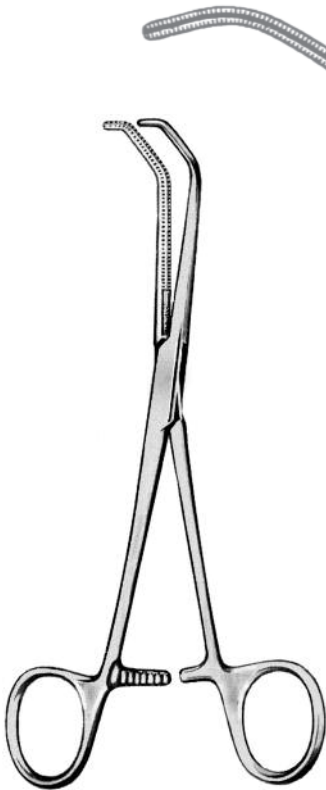

Cooley
17,0 cm TR-05-665-17

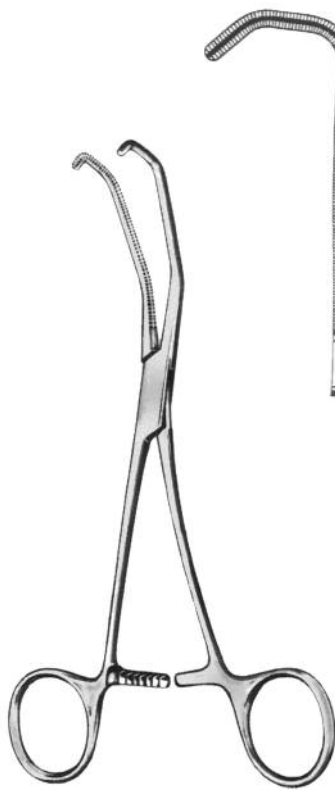

Cooley
17,0 cm TR-05-667-17

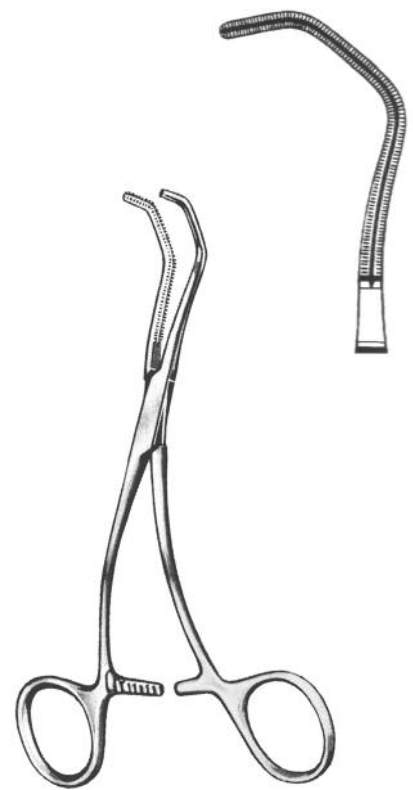

Cooley
16,0 cm TR-05-669-16

Atrauma Forceps



Cooley



15,0 cm
TR-05-671-15



16,0 cm
TR-05-671-16

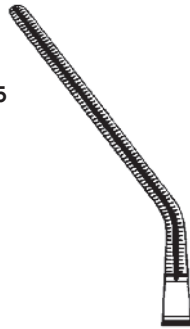

17,0 cm
TR-05-671-17



Cooley



16,0 cm
TR-05-672-16



17,0 cm
TR-05-672-17

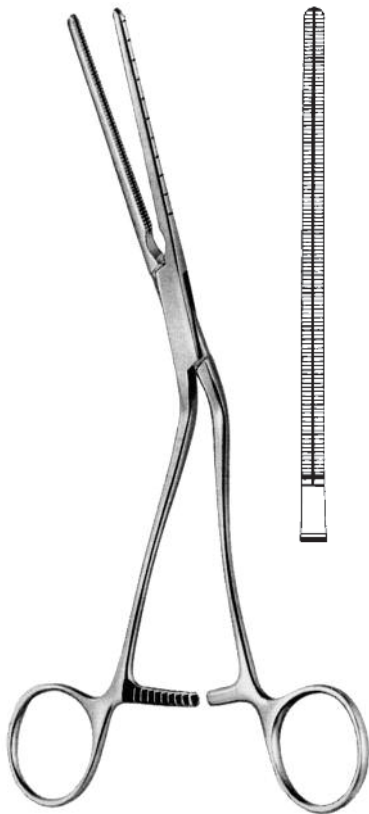

Cooley

21,0 cm TR-05-673-21

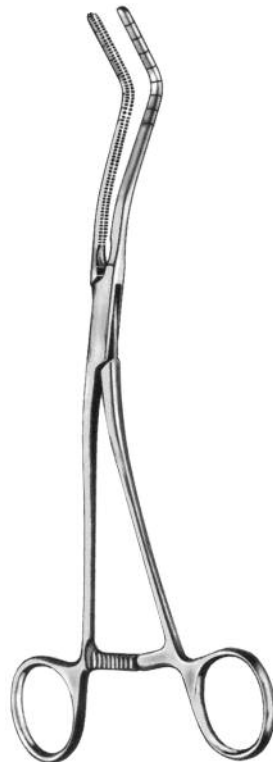

Cooley

20,0 cm



TR-05-675-20

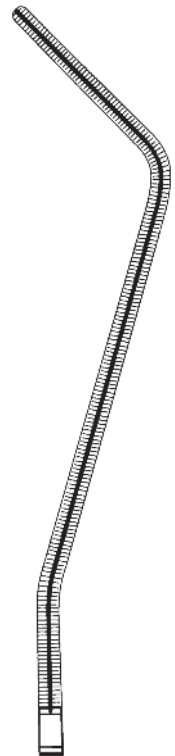

26,0 cm

TR-05-675-26

Atrauma Forceps

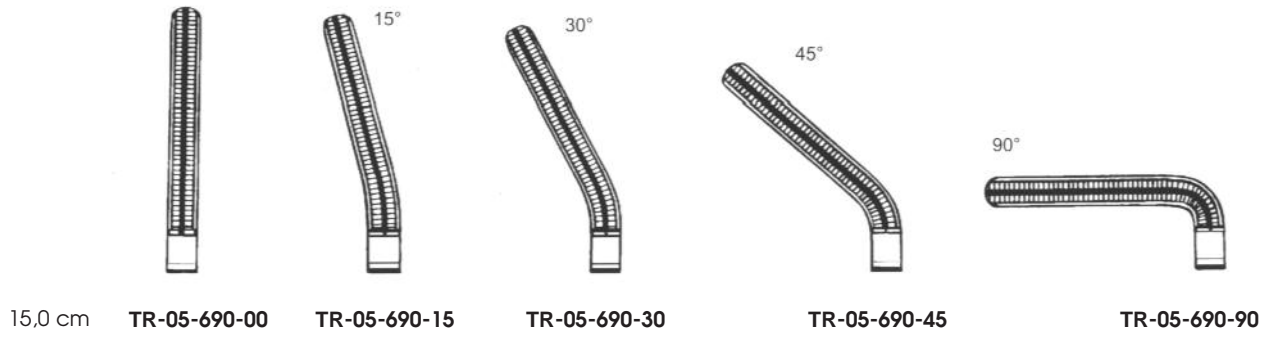

Dardik

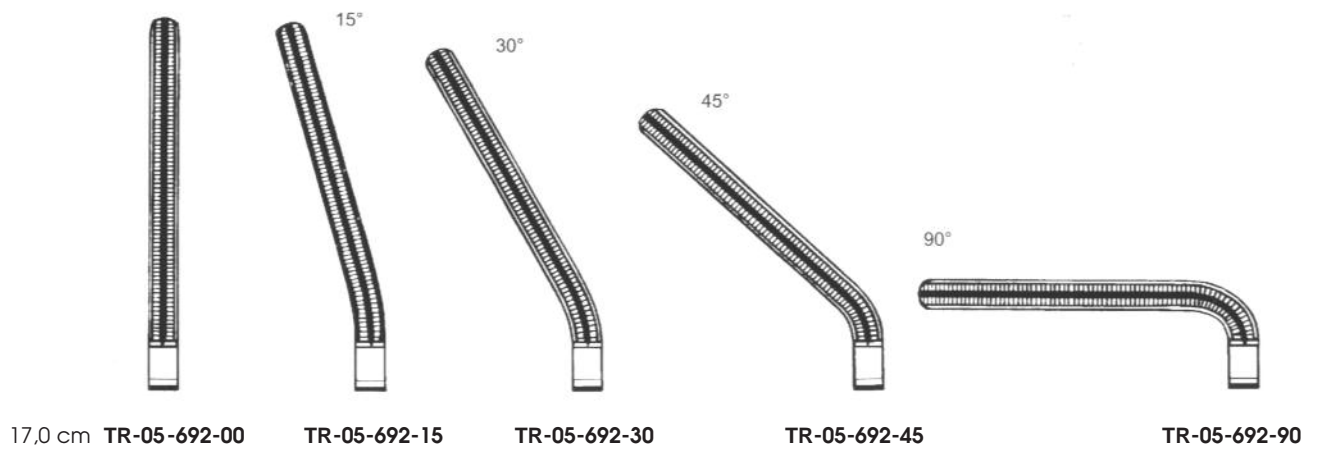

Dressing- and Sponge Forceps

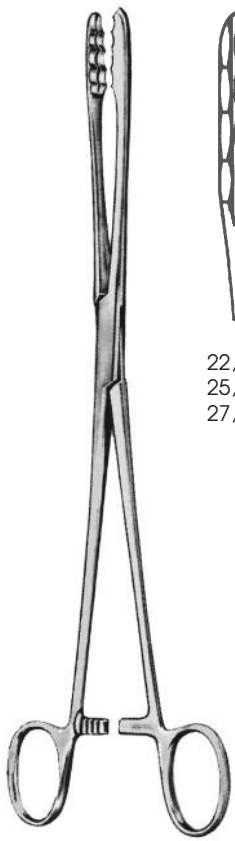

Ulrich

22,0 cm **TR-05-700-22**
25,0 cm **TR-05-700-25**
27,0 cm **TR-05-700-27**

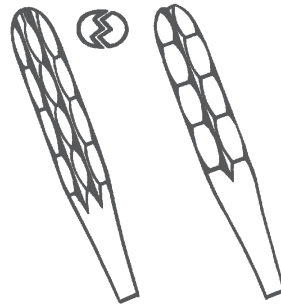

22,0 cm **TR-05-701-22**
25,0 cm **TR-05-701-25**
27,0 cm **TR-05-701-27**

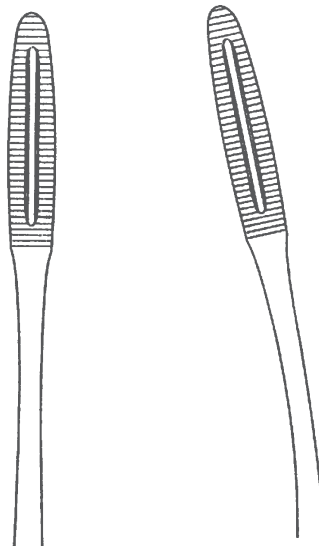

20,0 cm **TR-05-702-20**
22,0 cm **TR-05-702-22**
25,0 cm **TR-05-702-25**
27,0 cm **TR-05-702-27**

20,0 cm **TR-05-703-20**
22,0 cm **TR-05-703-22**
25,0 cm **TR-05-703-25**
27,0 cm **TR-05-703-27**

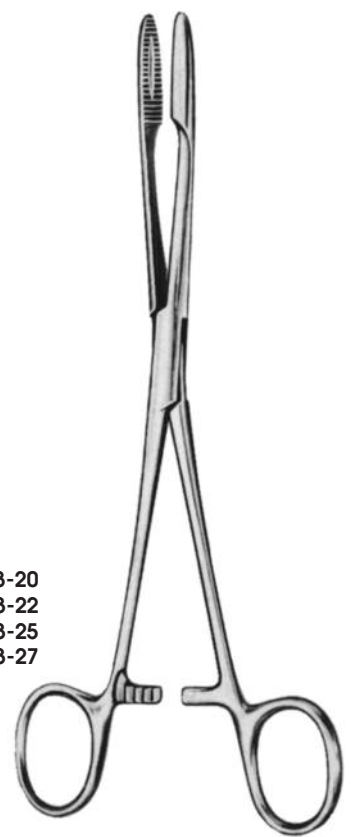

Gross-Maier

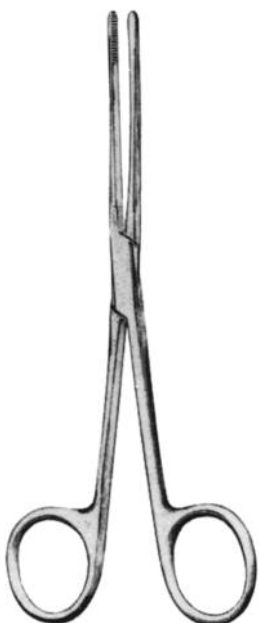

Lister, Sinus

13,0 cm
TR-05-714-13

16,0 cm
TR-05-714-16

18,0 cm
TR-05-714-18

Dressing-and Sponge Forceps



Bozemann
26,0 cm TR-05-716-26

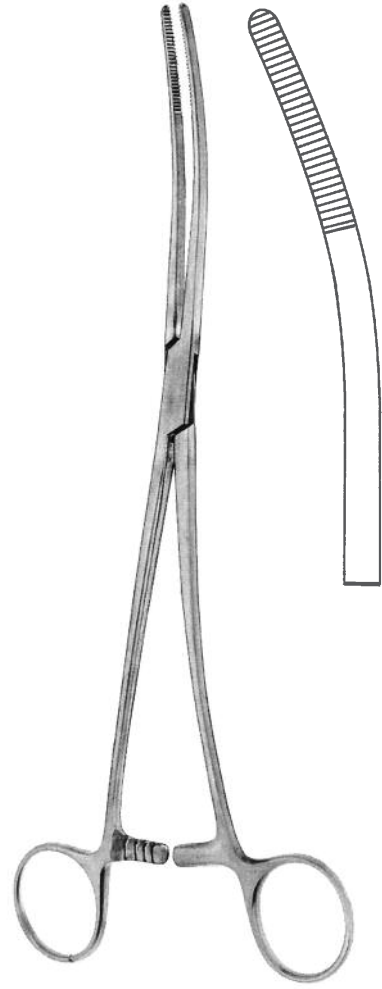

Bozemann
26,0 cm TR-05-717-26

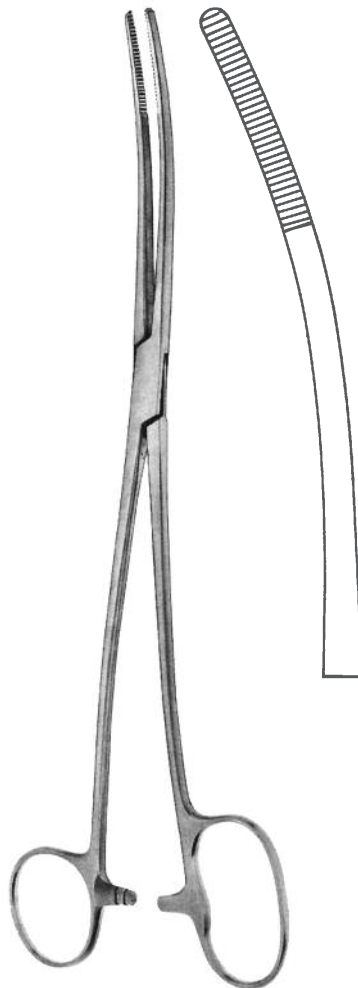

Bozemann
26,0 cm TR-05-719-26

Dressing-, Sponge Holding-, Organ and Tissue Grasping Forceps

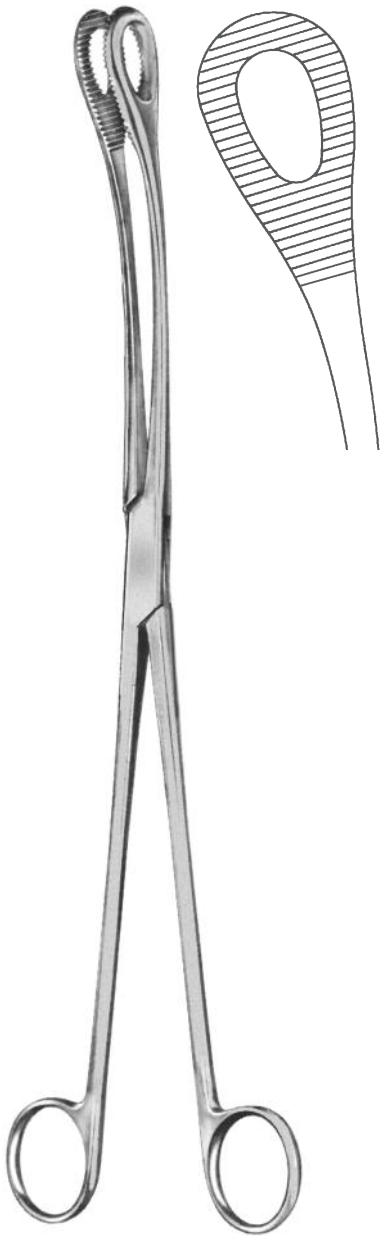

Kelly
32,0 cm TR-05-725-32



Noto
27,0 cm TR-05-726-27

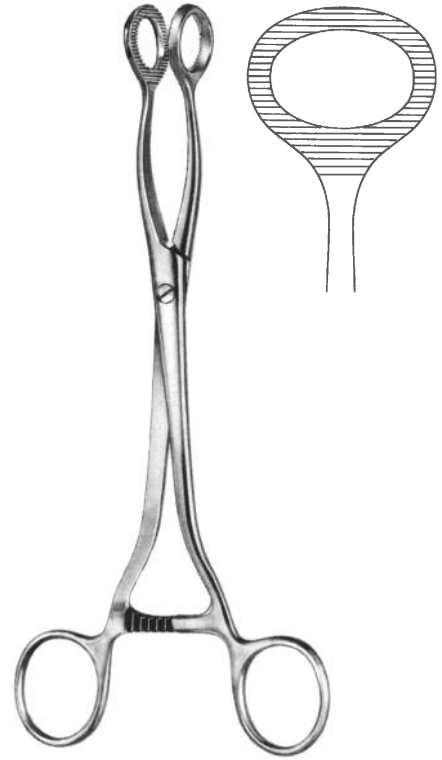

Doyen
20,5 cm TR-05-730-21

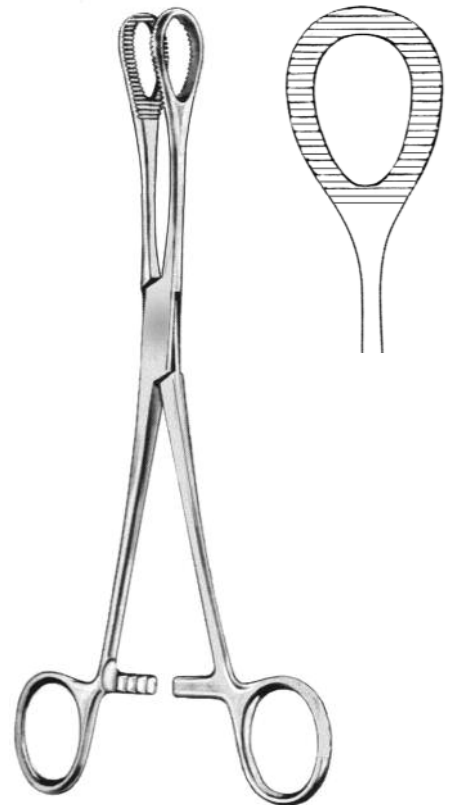

Doyen
21,5 cm TR-05-730-22

Dressing-, Sponge Holding-, Organ and Tissue Grasping Forceps



25,0 cm **TR-05-732-25**



26,0 cm **TR-05-732-26**



Polyps Atrauma forceps
Atrauma Tissue Grasping Forceps

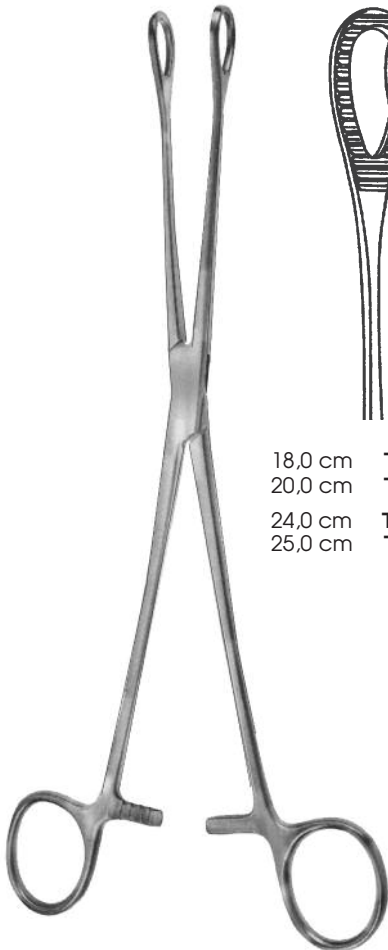

Forster-Ballenger forceps
Grasping Forceps

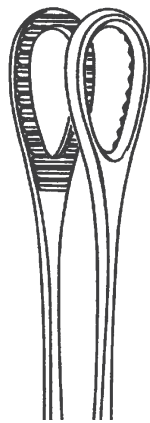

18,0 cm **TR-05-736-18**

20,0 cm **TR-05-736-20**

24,0 cm **TR-05-736-24**

25,0 cm **TR-05-736-25**

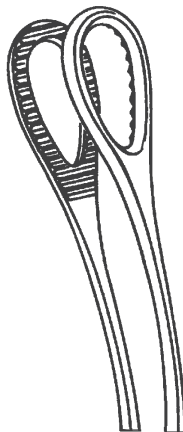

18,0 cm **TR-05-737-18**

20,0 cm **TR-05-737-20**

24,0 cm **TR-05-737-24**

25,0 cm **TR-05-737-25**

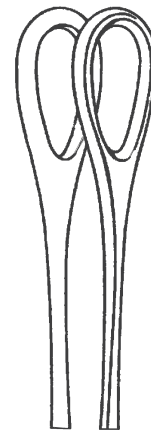

18,0 cm **TR-05-738-18**

20,0 cm **TR-05-738-20**

25,0 cm **TR-05-738-25**



18,0 cm **TR-05-739-18**

20,0 cm **TR-05-739-20**

25,0 cm **TR-05-739-25**

Dressing- and Organ Grasping Forceps

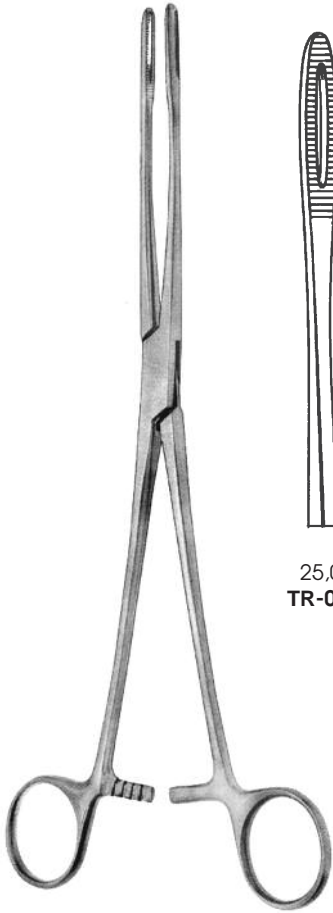

Förster



25,0 cm
TR-05-740-25

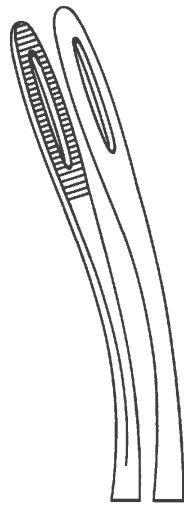

25,0 cm
TR-05-741-25

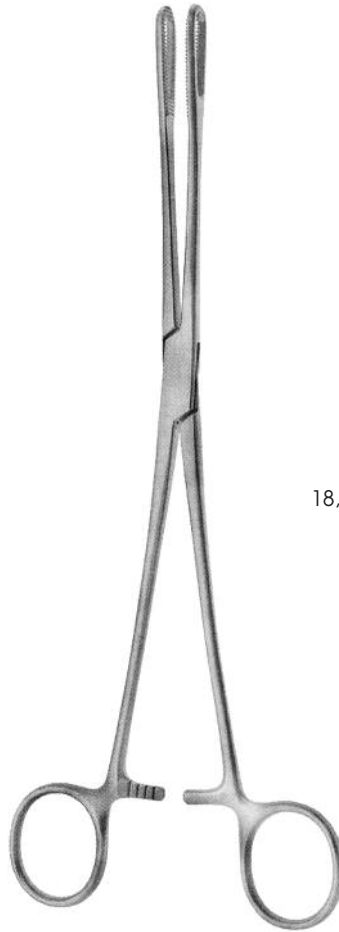

Rampley



18,0 cm **TR-05-742-18**



25,0 cm **TR-05-742-25**



Williams

16,0 cm **TR-05-744-16**



Collin

14,0 cm **TR-05-750-14**



Collin

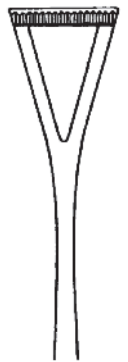

18,0 cm **TR-05-750-18**
20,0 cm **TR-05-750-20**

Dressing- and Organ Grasping Forceps



Collin, Atrauma



19,5 cm TR-05-751-19

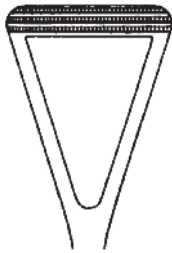

23,0 cm TR-05-751-23



Duval

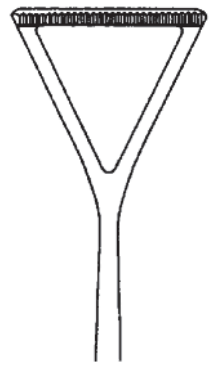

20,0 cm TR-05-752-20
23,0 cm TR-05-752-23

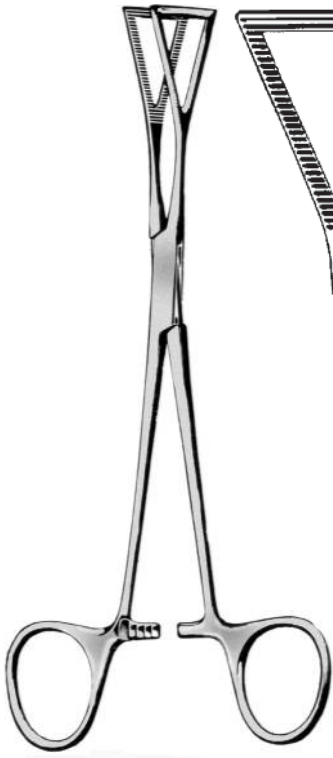

Lovelace

20,0 cm TR-05-754-20



Lovelace

20,0 cm TR-05-755-20



Pennington



15,0 cm
TR-05-756-15



20,0 cm
TR-05-756-20

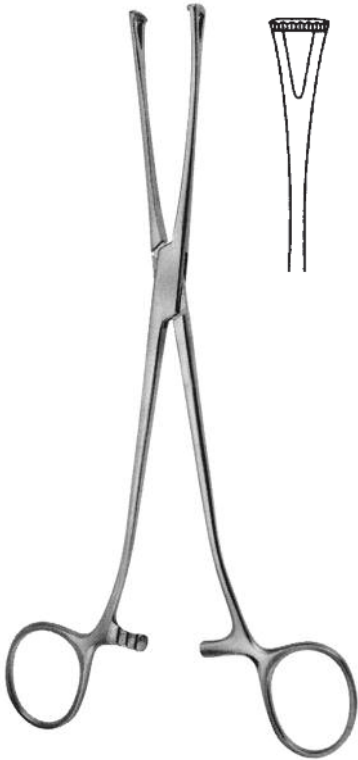

Lockwood
20,0 cm TR-05-758-20



Babcock
16,0 cm TR-05-760-16
18,0 cm TR-05-760-18
20,0 cm TR-05-760-20
24,0 cm TR-05-760-24

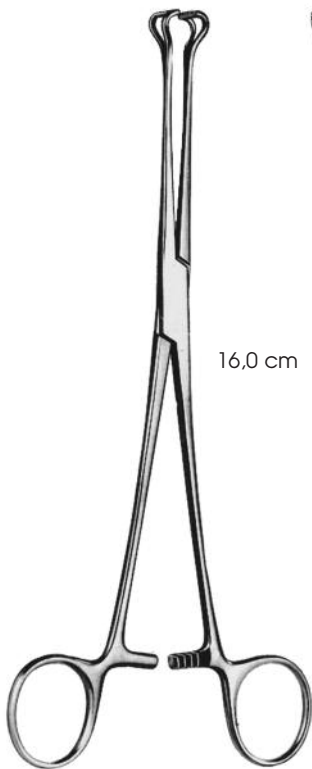

Babcock, Atrauma

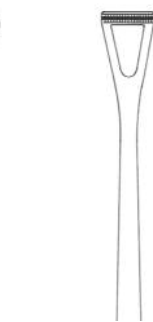

16,0 cm TR-05-762-16

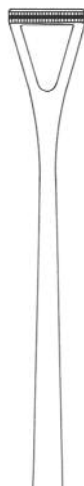

20,0 cm TR-05-762-20



Babcock TC



16,0 cm TR-05-764-16



20,0 cm TR-05-764-20



Baby-Allis,
12,0 cm **TR-05-766-12**



Allis
14,0 cm **TR-05-766-14**
15,5 cm **TR-05-765-15**



Allis
15,0 cm **TR-05-766-15**
15,5cm **TR-05-766-16**
19,0 cm **TR-05-766-19**
25,0 cm **TR-05-766-25**



Allis Atrauma



Allis-Thoms

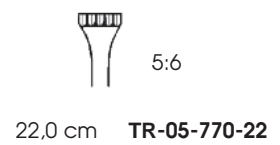
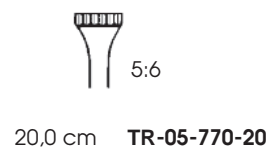

Tissue and Organ Grasping Forceps



Allis
20,0 cm TR-05-771-20



Judd-Allis
15,0 cm TR-05-772-15
19,0 cm TR-05-772-19



Boys-Allis
15,0 cm TR-05-774-15



Allis-Adair
15,0 cm TR-05-776-15



Tuffier
13,0 cm TR-05-778-13



Chaput
13,0 cm TR-05-780-13

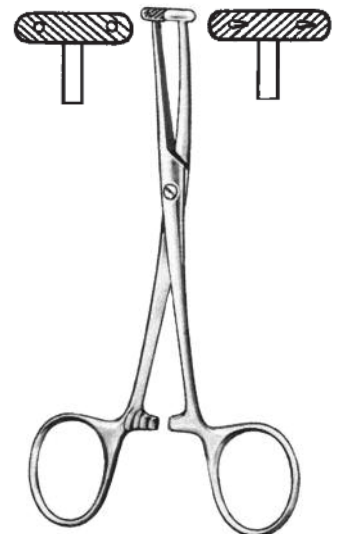

Martel
14,0 cm TR-05-786-14



Backhaus

8,0 cm **TR-05-801-08**
11,0 cm **TR-05-801-11**
13,0 cm **TR-05-801-13**
15,0 cm **TR-05-801-15**

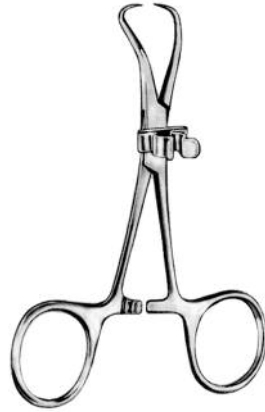

Backhaus

11,0 cm **TR-05-803-11**



Backhaus

11,0 cm **TR-05-804-11**
13,0 cm **TR-05-804-13**



Towel Forceps

11,0 cm **TR-05-805-11**
14,0 cm **TR-05-805-14**



Bernhard

16,0 cm **TR-05-807-16**

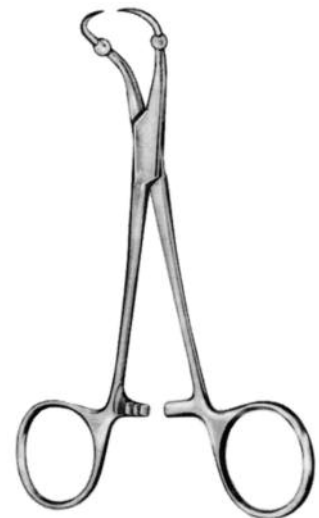

Roeder

13,0 cm **TR-05-809-13**
15,0 cm **TR-05-809-15**

Towel Forceps



Lane

13,0 cm TR-05-811-13
15,0 cm TR-05-811-15
20,0 cm TR-05-811-20



9,0 cm TR-05-816-09



Schädel



9,0 cm TR-05-817-09



Jones

9,0 cm TR-05-819-09



Jones

9,0 cm TR-05-820-09

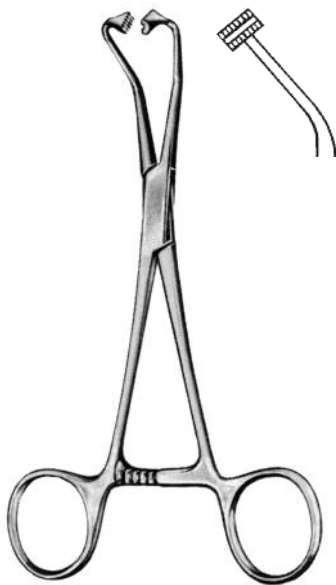

Bertram

14,0 cm TR-05-821-14

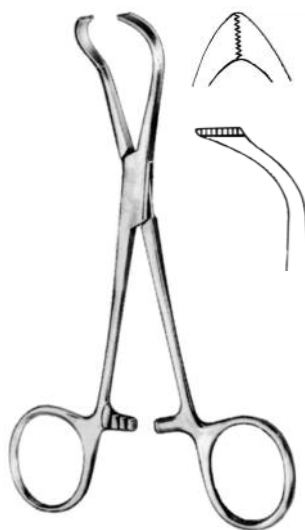

Lorna

10,0 cm TR-05-823-10
13,0 cm TR-05-823-13



Tohoku

10,0 cm TR-05-825-10
13,0 cm TR-05-825-13

Tubing Clamps



16,0 cm **TR-05-840-16**
18,0 cm **TR-05-840-18**
20,0 cm **TR-05-840-20**

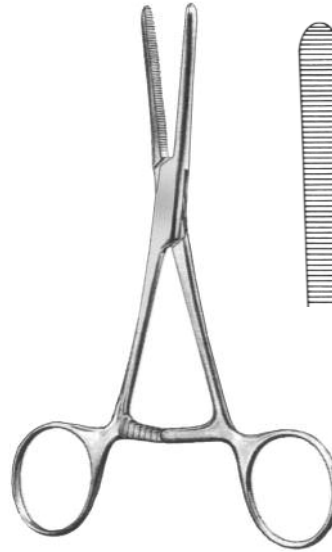

14,0 cm **TR-05-842-14**
16,0 cm **TR-05-842-16**
20,0 cm **TR-05-842-20**



15,0 cm
TR-05-844-15



18,0 cm
TR-05-844-18



20,0 cm
TR-05-844-20



15,0 cm
TR-05-846-15



18,0 cm
TR-05-846-18



20,0 cm
TR-05-846-20

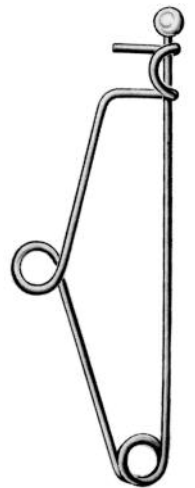

13,0 cm
TR-05-851-13



06

Retractors

TRS INSTRUMENTS

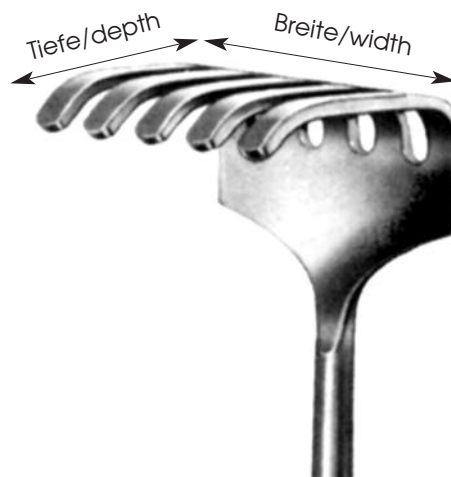

Dimensions for blade size of retractors

Measure 1 - depth
Measure 2 - width

Example: 24x42 mm

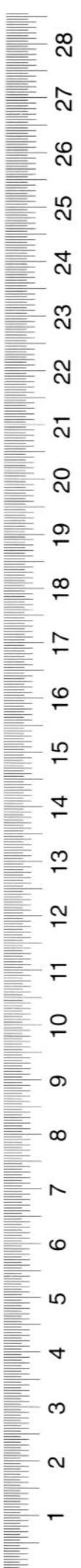

Retractors



Volkmann

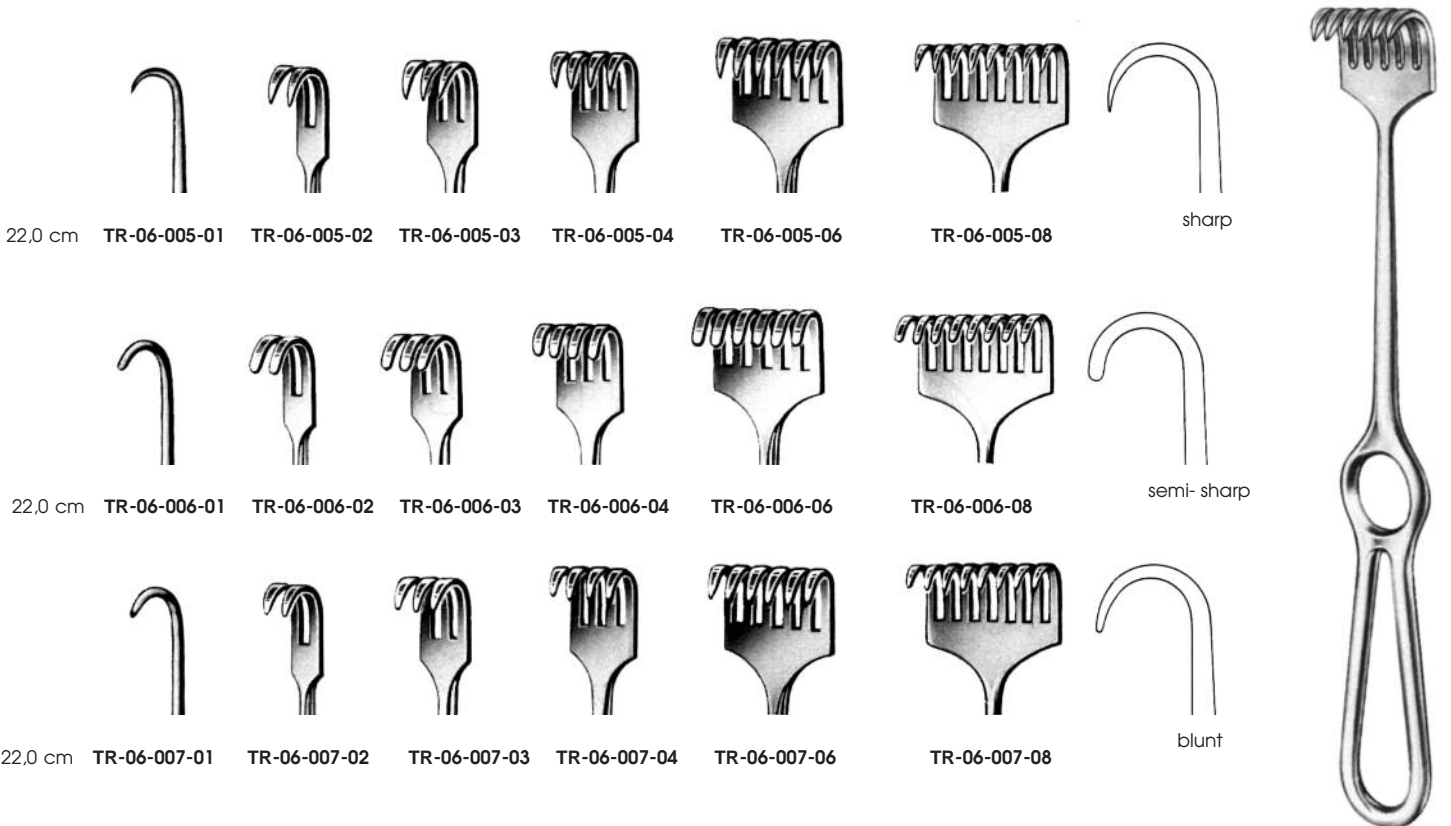
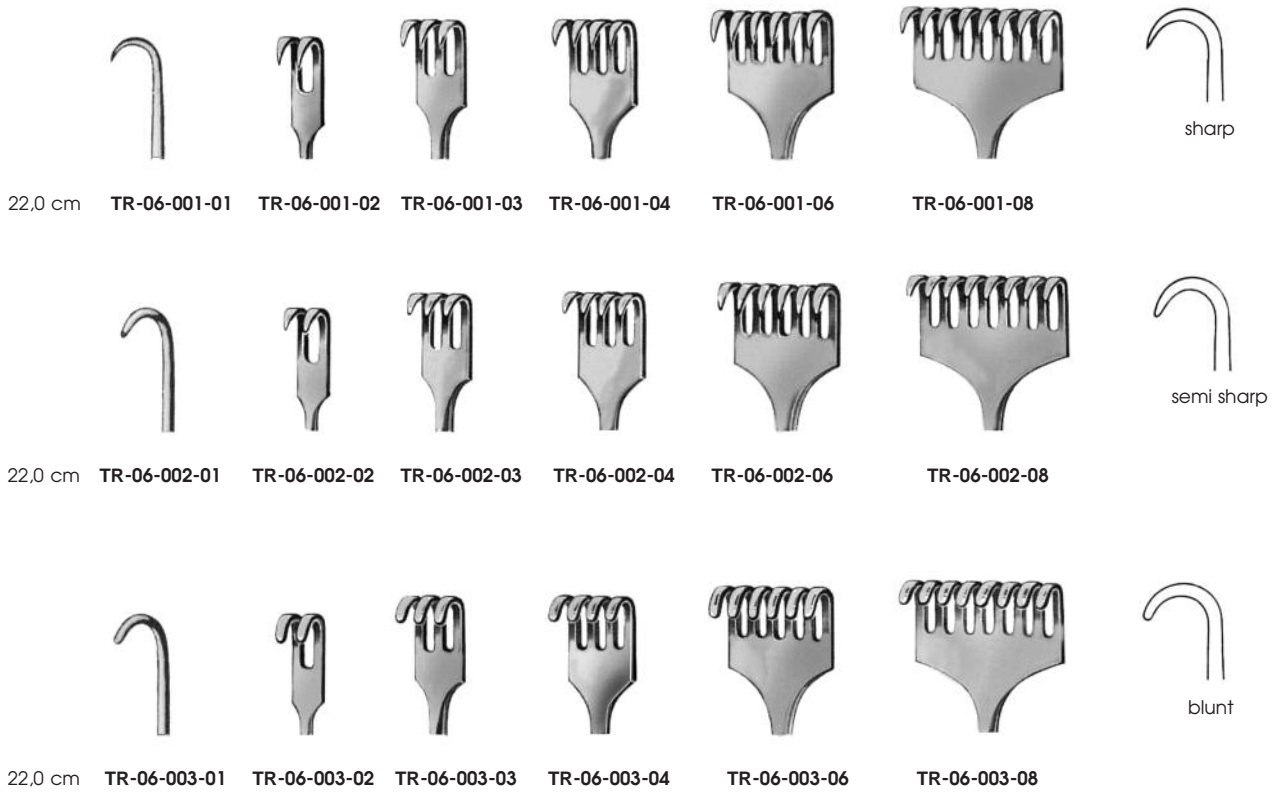

Kocher



Volkman



22,0 cm TR-06-008-01 TR-06-008-02 TR-06-008-03 TR-06-008-04 TR-06-008-06
21,0 cm TR-06-018-01 TR-06-018-02 TR-06-018-03 TR-06-018-04 TR-06-018-06



22,0 cm TR-06-009-01 TR-06-009-02 TR-06-009-03 TR-06-009-04 TR-06-009-06
21,0 cm TR-06-019-01 TR-06-019-02 TR-06-019-03 TR-06-019-04 TR-06-019-06

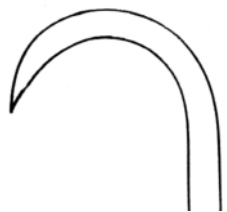

22,0 cm TR-06-010-01



TR-06-010-02



TR-06-010-03

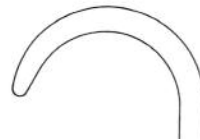

TR-06-011-01

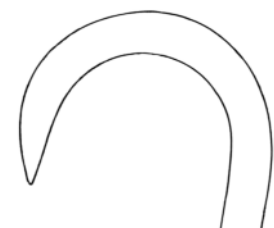

22,0 cm TR-06-012-01

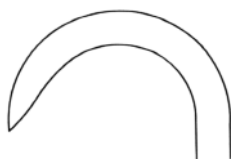

TR-06-012-12

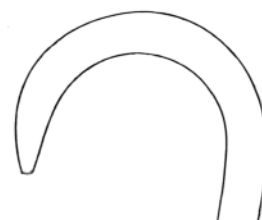

TR-06-013-01



Volkman

Retractors



Koerte

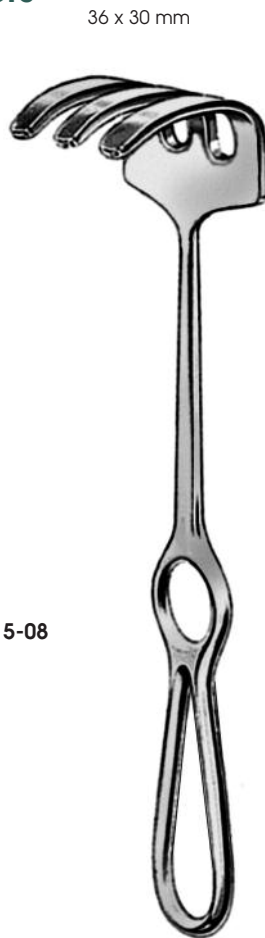

Ollier
24,0 cm **TR-06-016-03**

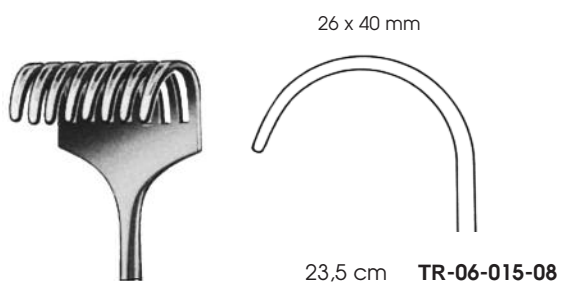
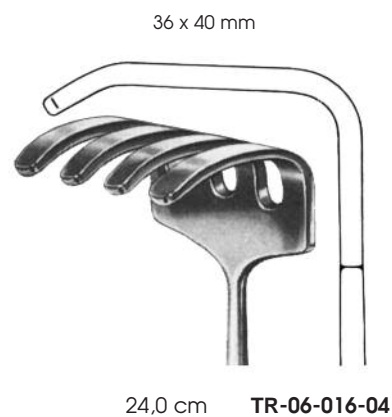

23,5 cm **TR-06-015-08**

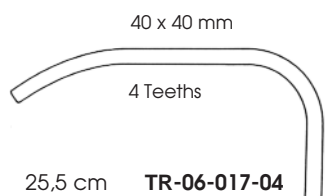

25,5 cm **TR-06-017-04**

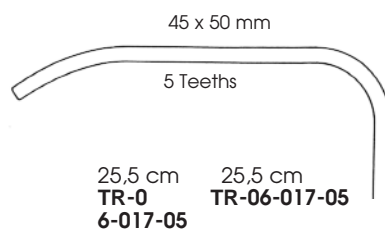

25,5 cm **TR-06-017-05**

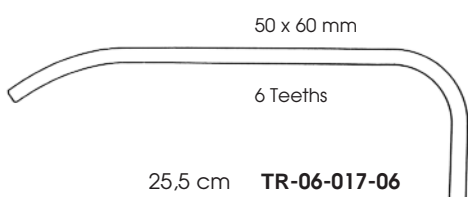

25,5 cm **TR-06-017-06**

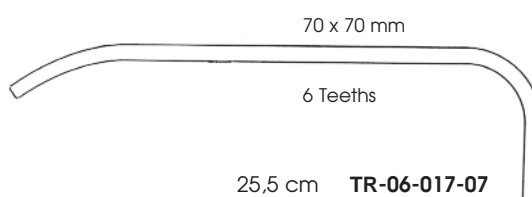

25,5 cm **TR-06-017-07**



Israel

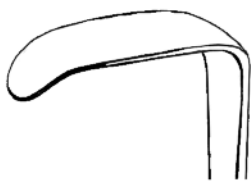

21,0 cm **TR-06-018-01**

30x11 mm

TR-06-018-11 22,0 cm



21,0 cm **TR-06-018-02**

30x14 mm

TR-06-018-12 22,0 cm



21,0 cm **TR-06-018-03**

30x16 mm

TR-06-018-13 22,0 cm

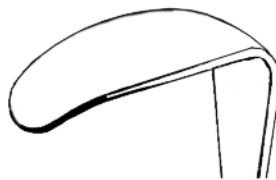

21,0 cm **TR-06-018-04**

33x14 mm

TR-06-018-14 22,0 cm



21,0 cm **TR-06-018-05**

40x11 mm

TR-06-018-15 22,0 cm



21,0 cm **TR-06-018-06**

42x13 mm

TR-06-018-16 22,0 cm



21,0 cm **TR-06-018-07**

50x11 mm

TR-06-018-17 22,0 cm



Langenbeck



Langenbeck

Retractors

85x15 mm

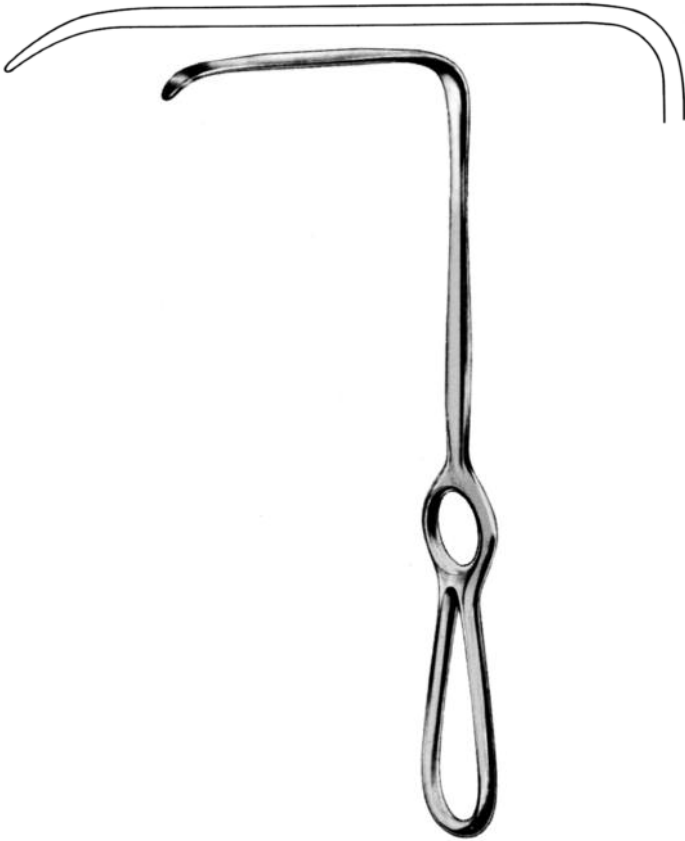

Langenbeck

22,0 cm TR-06-019-01



Obwegeser

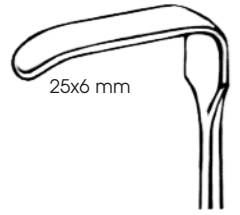

25x6 mm

22,0 cm TR-06-021-01

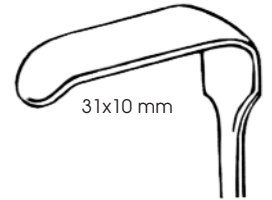

31x10 mm

22,0 cm TR-06-021-02

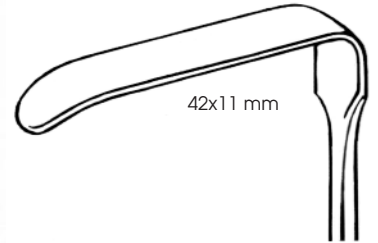

42x11 mm

22,0 cm TR-06-021-03



60x20 mm

Langenbeck

21,0 cm TR-06-020-01

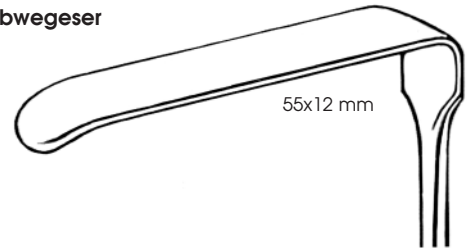

55x12 mm

22,0 cm TR-06-021-04

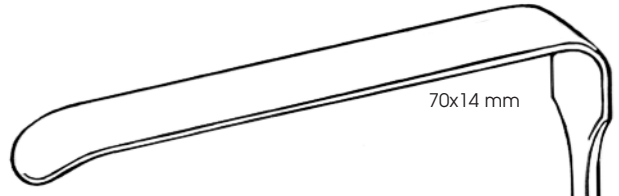

70x14 mm

22,0 cm TR-06-021-05

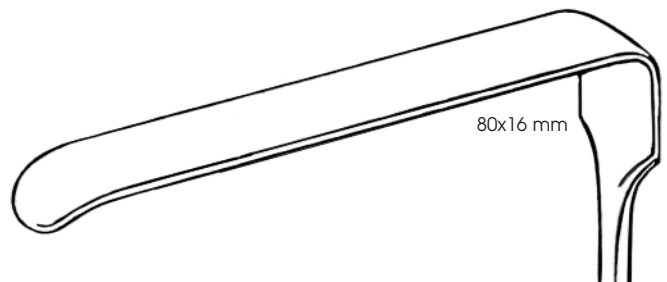

80x16 mm

22,0 cm TR-06-021-06

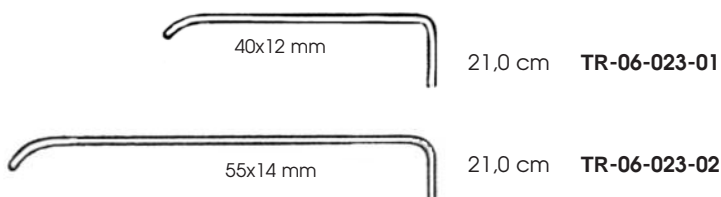

Dockhorn



Kocher-Langenbeck

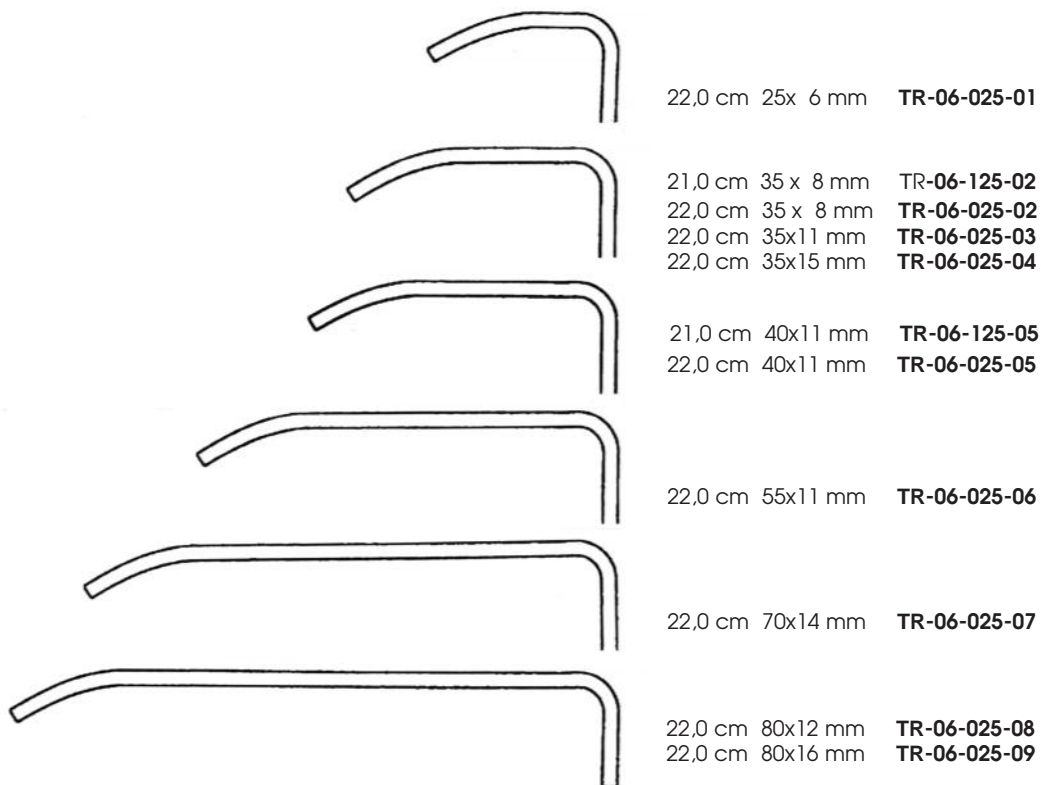

Retractors



Zenker

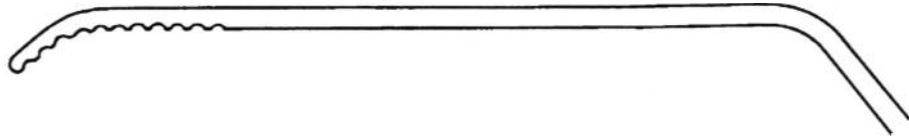

29,0 cm 120x12 mm **TR-06-026-04**

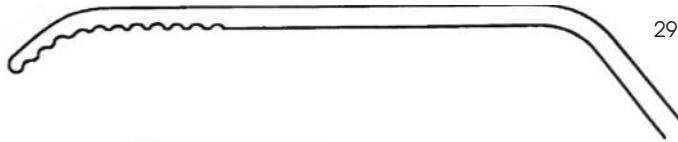

27,0 cm 75x12 mm **TR-06-026-03**



26,0 cm 60x12 mm **TR-06-026-02**

24,0 cm 36x8 mm **TR-06-026-01**

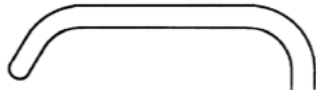

23,0 cm 40x18 mm **TR-06-027-01**

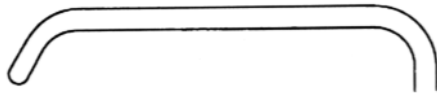

23,0 cm 60x20 mm **TR-06-027-02**

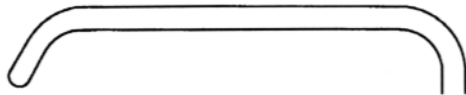

23,0 cm 60x25 mm **TR-06-027-03**

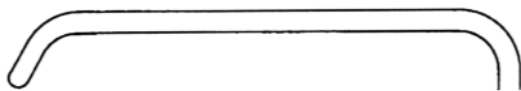

23,0 cm 75x30 mm **TR-06-027-04**

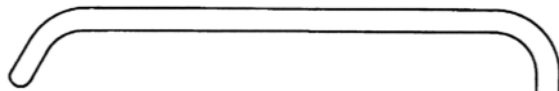

23,0 cm 75x40 mm **TR-06-027-05**



Kocher

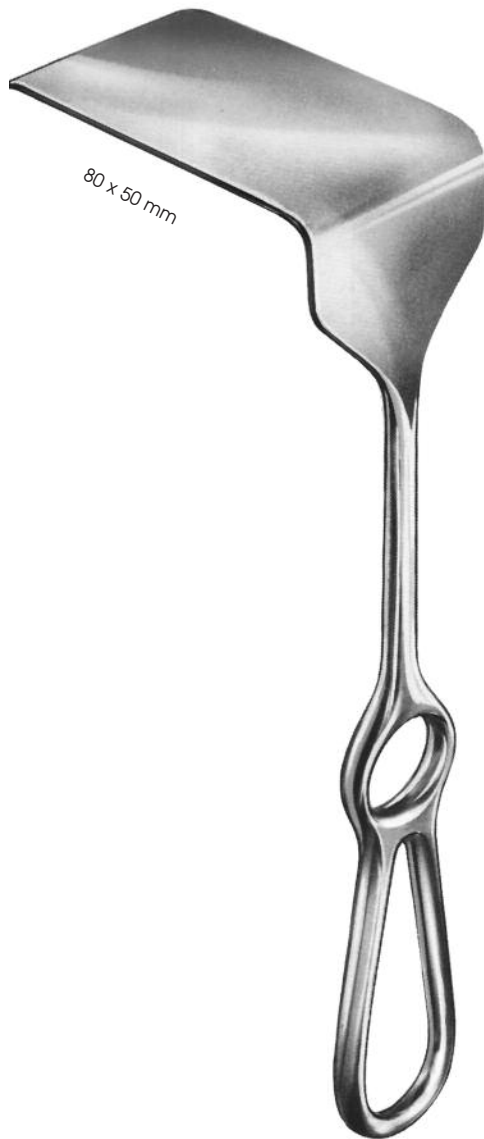

Mikulicz
26,0 cm **TR-06-028-01**



Mikulicz
25,0 cm **TR-06-028-02**

Retractors



125x37 mm

Sauerbruch
25,0 cm TR-06-029-03



82x22 mm

Coryllos
25,0 cm TR-06-030-01



110x40 mm

Coryllos
25,0 cm TR-06-030-02



115x65 mm

Coryllos
25,0 cm TR-06-030-03

26,0 cm 180x30 mm **TR-06-031-06**

26,0 cm 160x30 mm **TR-06-031-05**

26,0 cm 140x30 mm **TR-06-031-04**

26,0 cm 130x30 mm **TR-06-031-07**

26,0 cm 120x25 mm **TR-06-031-03**

26,0 cm 100x25 mm **TR-06-031-02**

26,0 cm 80x20 mm **TR-06-031-01**

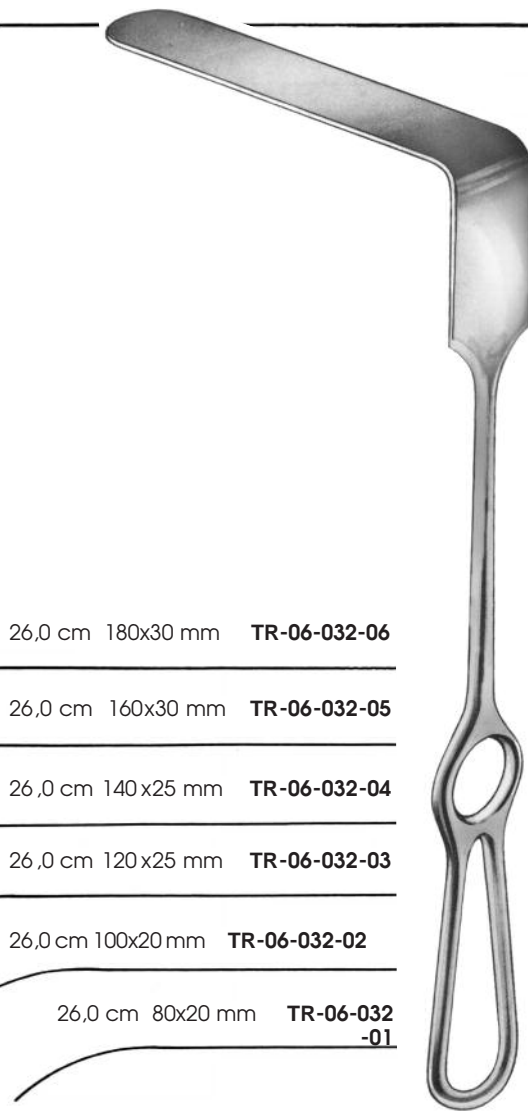

Brunner

26,0 cm 180x30 mm **TR-06-032-06**

26,0 cm 160x30 mm **TR-06-032-05**

26,0 cm 140x25 mm **TR-06-032-04**

26,0 cm 120x25 mm **TR-06-032-03**

26,0 cm 100x20 mm **TR-06-032-02**

26,0 cm 80x20 mm **TR-06-032-01**

Retractors



19x12 mm

20,5 cm **TR-06-033-01**



21x14 mm

20,5 cm **TR-06-033-02**

Kocher



40x10 mm



22,0 cm **TR-06-034-01**

40x15 mm

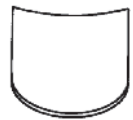

22,0 cm **TR-06-034-02**

40x20 mm



22,0 cm **TR-06-034-03**

Kocher



14x17 mm

22,0 cm **TR-06-035-01**



20x22 mm

22,0 cm **TR-06-035-02**



26x30 mm

22,0 cm **TR-06-035-03**



Middendorpf



45x45 mm

27,0 cm **TR-06-036-01**



45x50 mm

27,0 cm **TR-06-036-02**

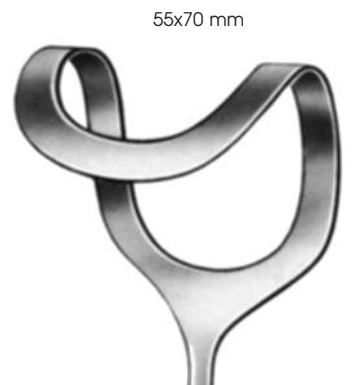

55x70 mm

27,0 cm **TR-06-036-03**

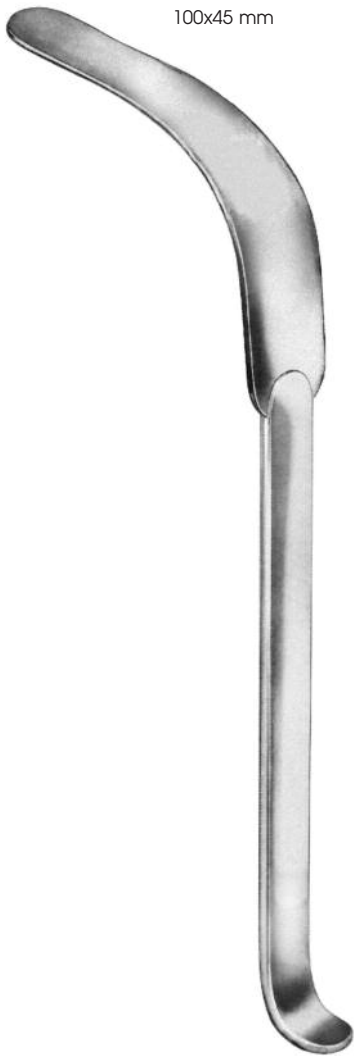

100x45 mm

Kümmel

28,0 cm **TR-06-037-28**

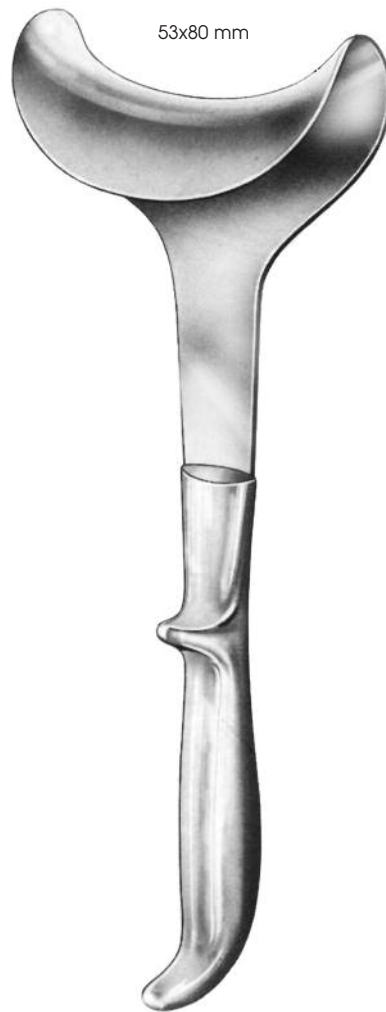

53x80 mm

Doyen

25,0 cm **TR-06-038-25**

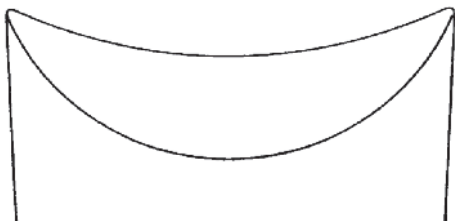

24,0 cm 40x60 mm **TR-06-039-03**



24,0 cm 40x50 mm **TR-06-039-02**



24,0 cm 40x40 mm **TR-06-039-01**

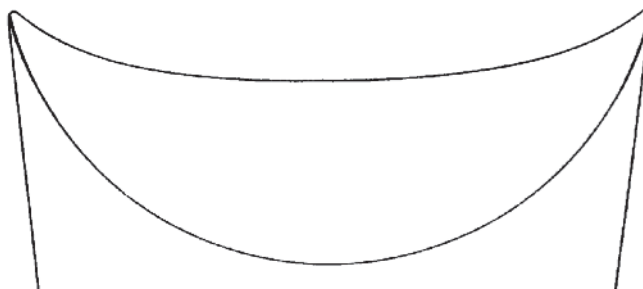

24,0 cm 40x85 mm **TR-06-039-05**

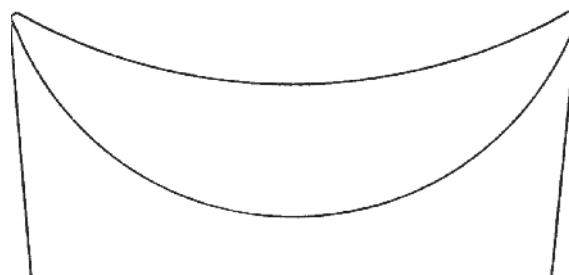

24,0 cm 40x75 mm **TR-06-039-04**



Fritsch

Retractors

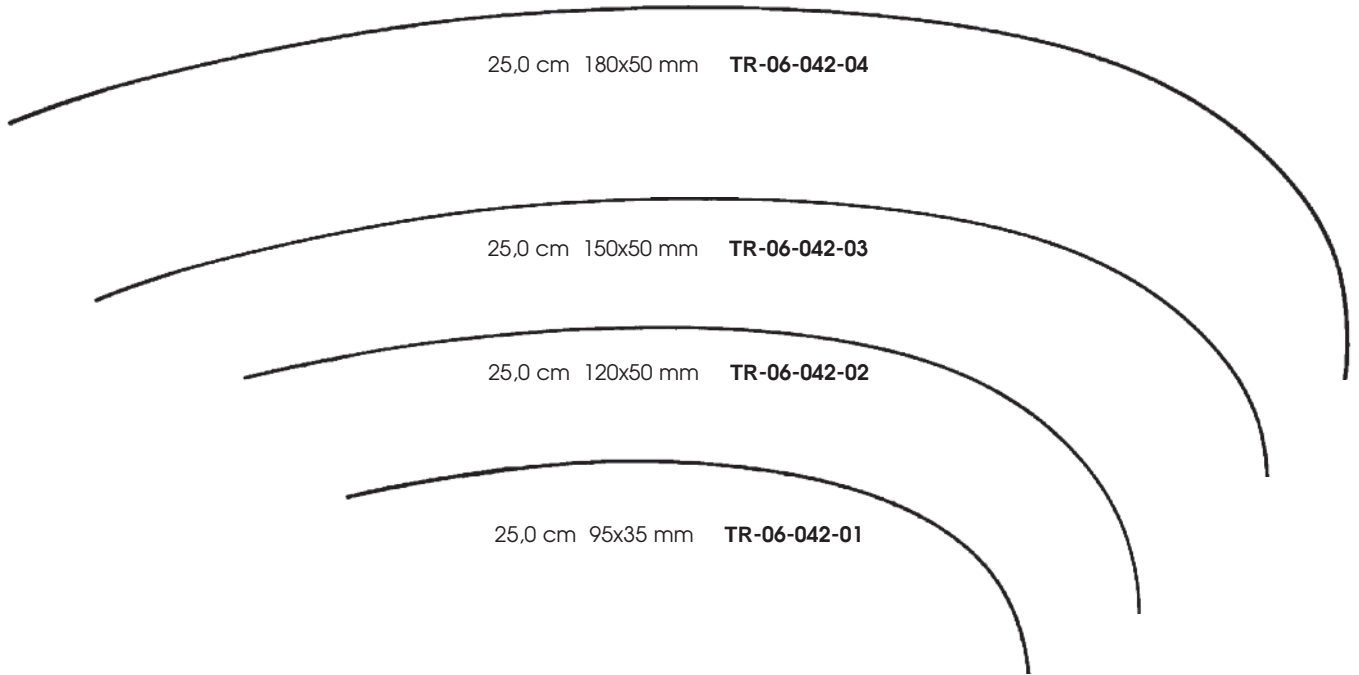

Kocher
25,0 cm 75x25 mm **TR-06-040-01**

Kocher
25,0 cm 80x45 mm **TR-06-041-01**
25,0 cm 80x55 mm **TR-06-041-02**
25,0 cm 80x65 mm **TR-06-041-03**

Mikulicz

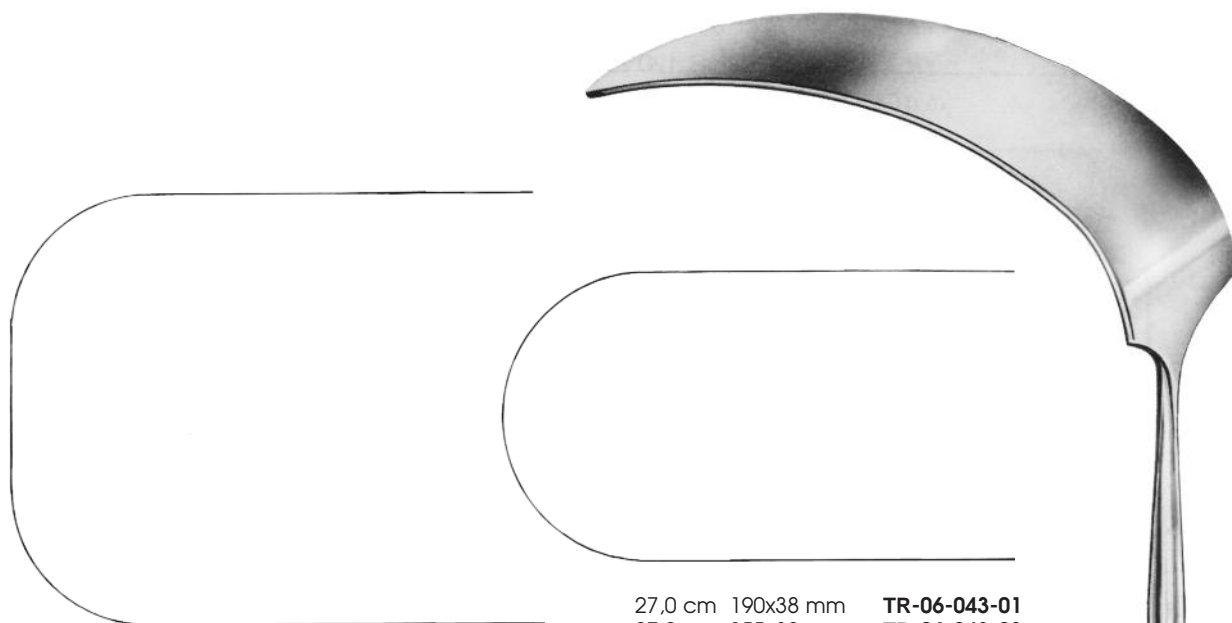

27,0 cm 190x57 mm **TR-06-043-02**
27,0 cm 155x57 mm **TR-06-043-04**

27,0 cm 190x38 mm **TR-06-043-01**
27,0 cm 155x38 mm **TR-06-043-03**

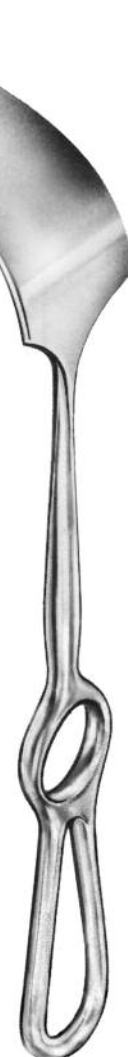

Kelly



Doyen

22,0 cm 90x28 mm **TR-06-044-01**
22,0 cm 105x30 mm **TR-06-044-02**
22,0 cm 120x52 mm **TR-06-044-03**

Retractors

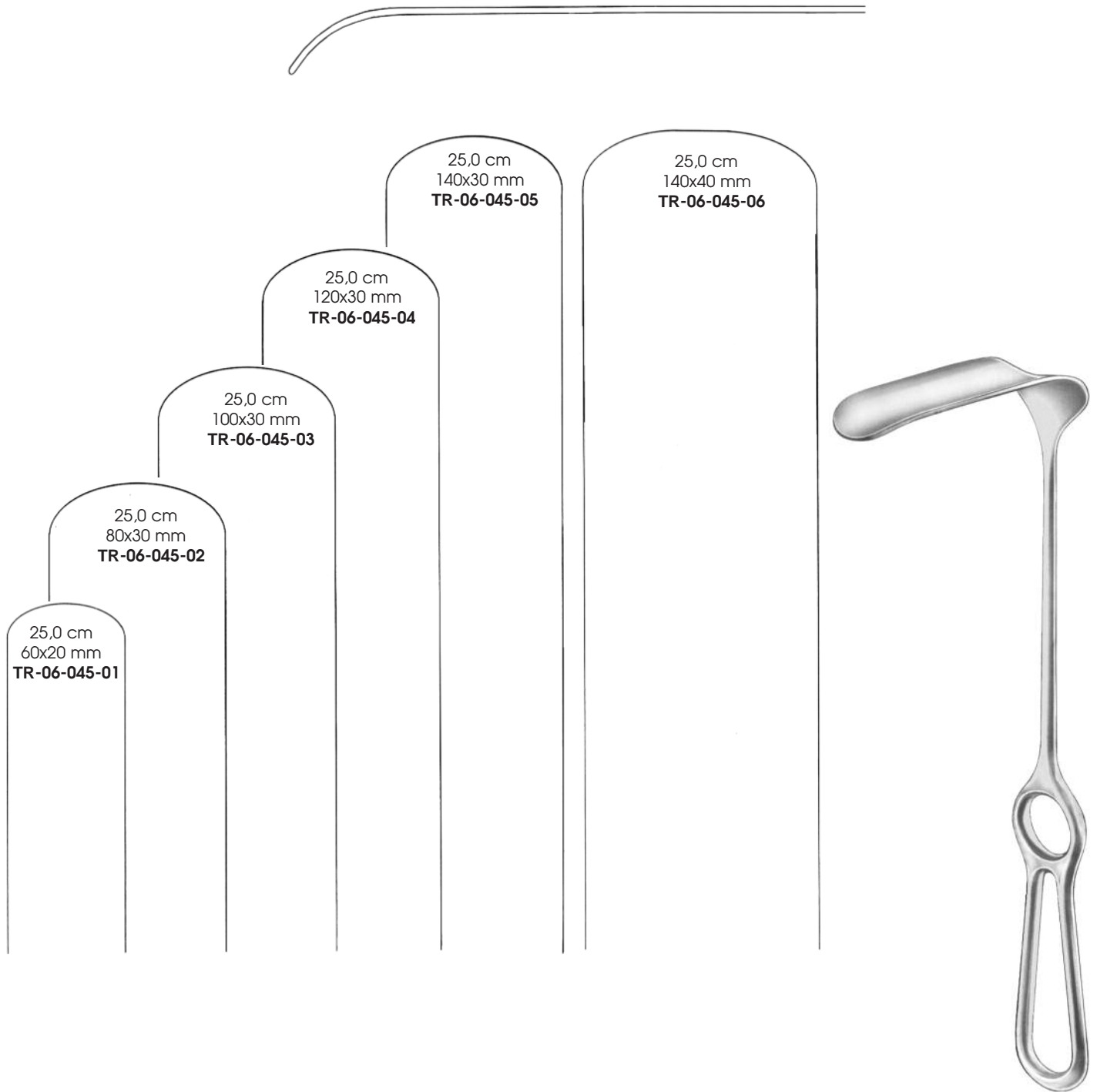

Hösel

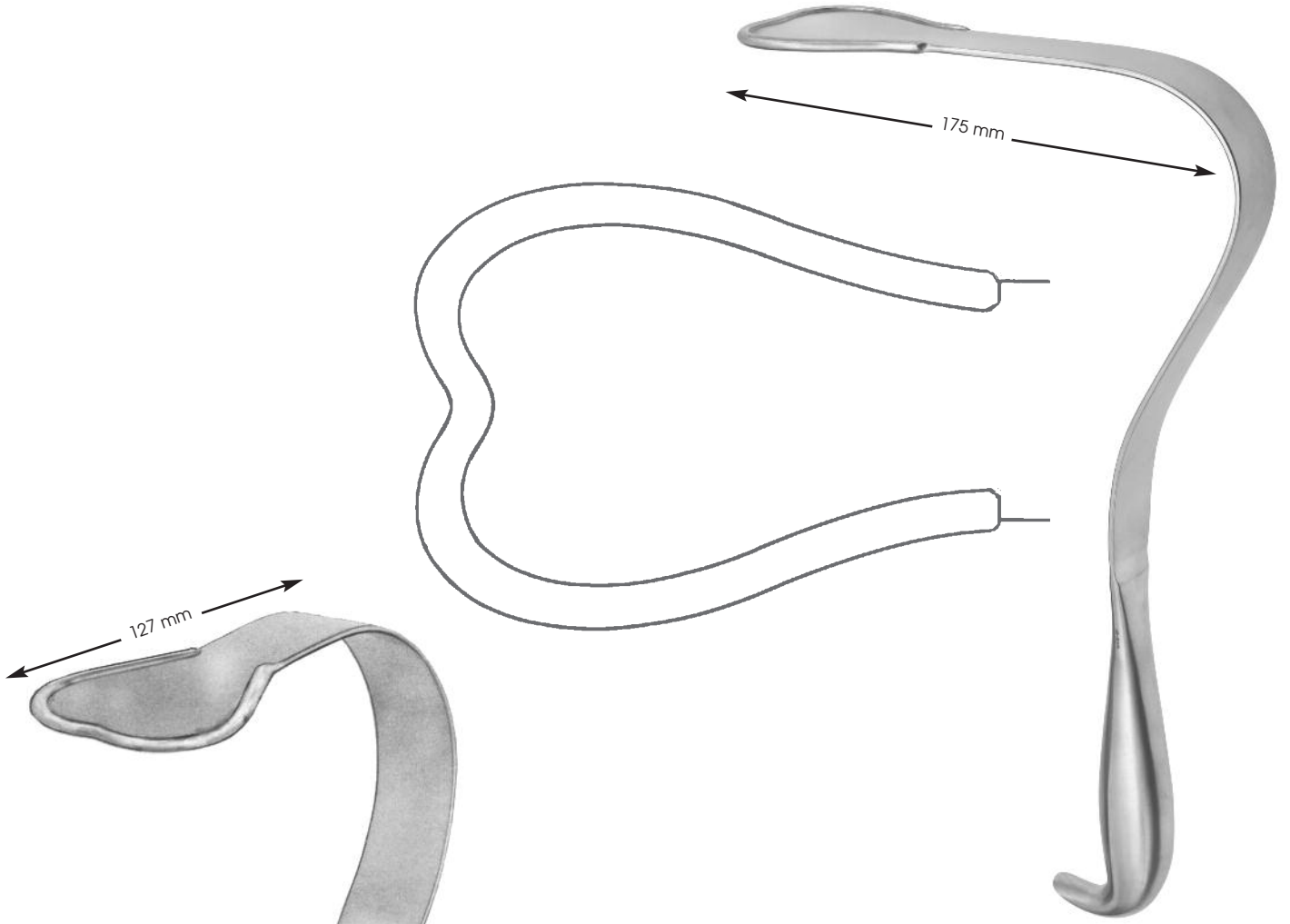

Harrington
32,0 cm 175x64 mm **TR-06-046-03**



Harrington

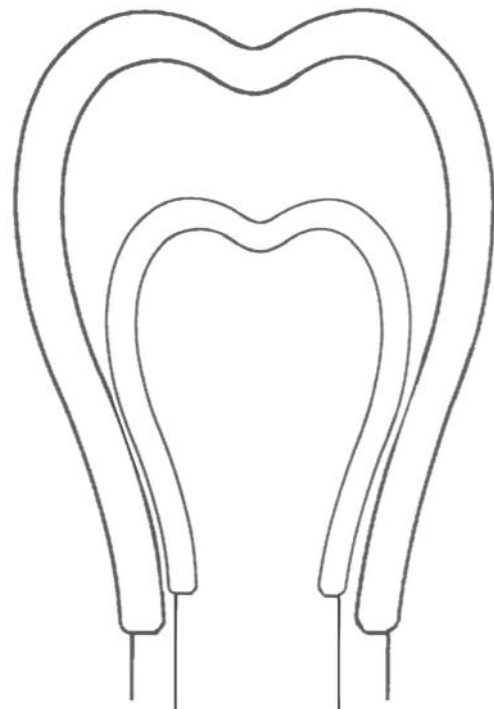
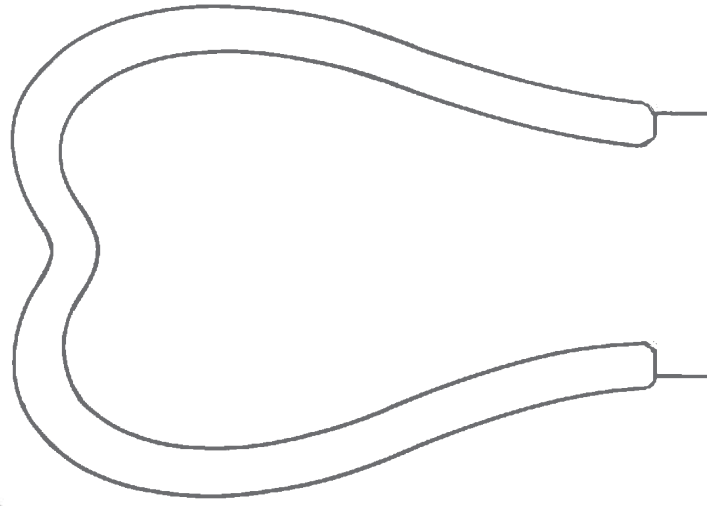

32,0 cm 127x64 mm **TR-06-046-02**
32,0 cm 127x40 mm **TR-06-046-01**

Retractors

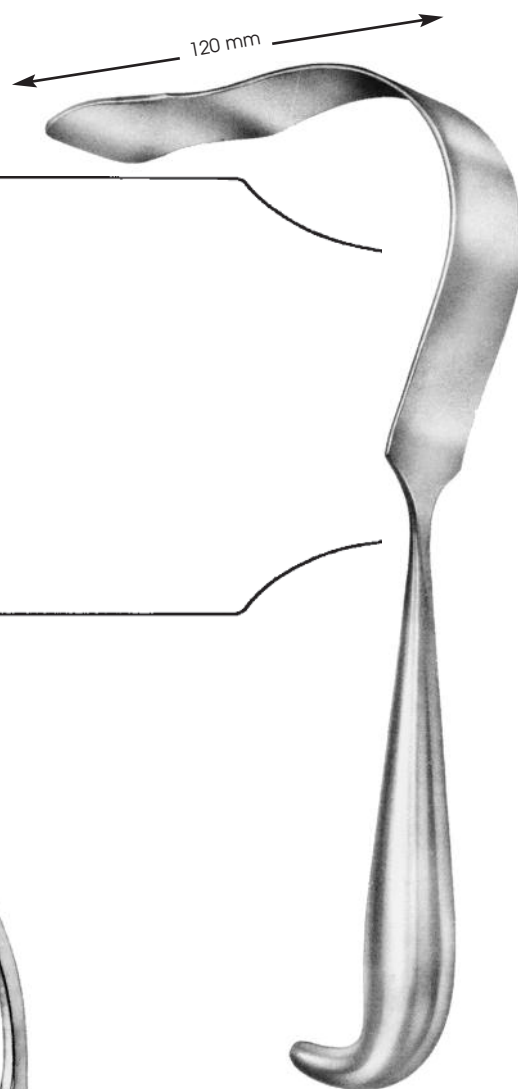

Polloson

27,0 cm **TR-06-046-11**



Polloson

27,0 cm **TR-06-046-12**

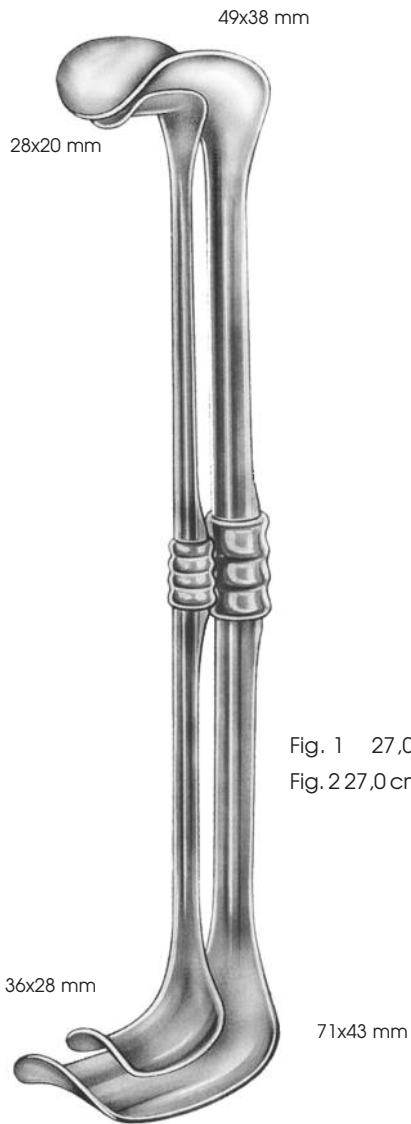

Richardson-Eastman,
27,0 cm / Set **TR-06-047-00**

Fig. 1 27,0 cm **TR-06-047-01**

Fig. 2 27,0 cm **TR-06-047-02**

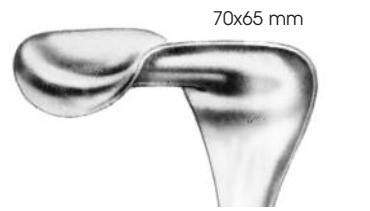

Kelly
TR-06-047-27

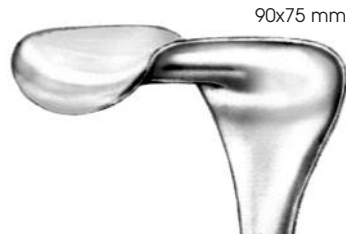

Kelly
TR-06-047-28



Richardson/Kelly



Richardson
TR-06-047-11

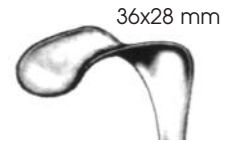

Richardson
TR-06-047-12



Richardson
TR-06-047-13



Richardson
TR-06-047-14



Kelly
TR-06-047-25



Kelly
TR-06-047-26

Retractors

26,5 cm 95x20 mm **TR-06-048-01**



25,0 cm 105x27 mm **TR-06-048-02**



27,5 cm 115x22 mm **TR-06-048-03**
27,5 cm 115x26 mm **TR-06-048-04**



75x90 mm **TR-06-047-90**



75x50 mm **TR-06-047-50**

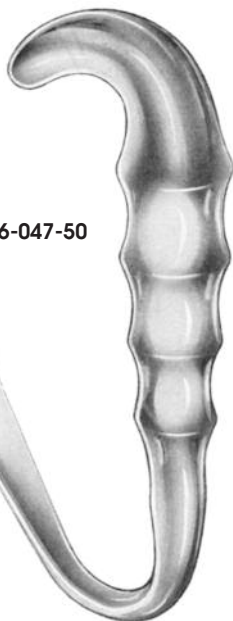

Davidson

Modell Tübingen

Martin

Simon

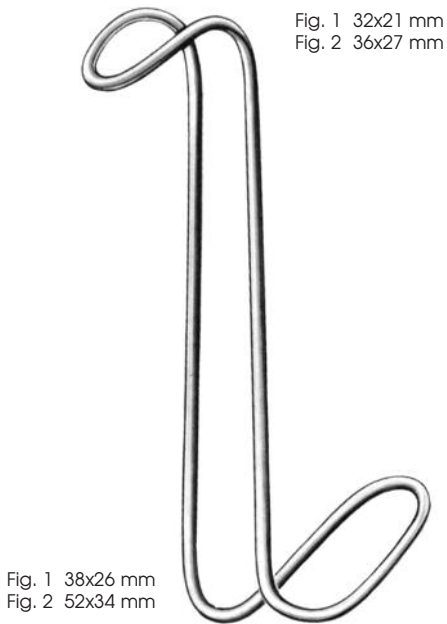

Fig. 1 38x26 mm
Fig. 2 52x34 mm

Collin-Hartmann

Fig. 1 14,0 cm **TR-06-049-01**
Fig. 2 16,0 cm **TR-06-049-02**



Roux

Fig. 1 **TR-06-050-01**
Fig. 2 **TR-06-050-02**
Fig. 3 **TR-06-050-03**

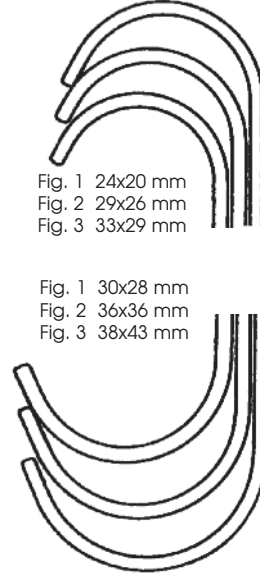

Fig. 1 24x20 mm
Fig. 2 29x26 mm
Fig. 3 33x29 mm

Fig. 1 30x28 mm
Fig. 2 36x36 mm
Fig. 3 38x43 mm

Roux

Satz / Set, komplett

TR-06-050-00



15x15 mm

18x21 mm

Baby-Roux

13,5 cm **TR-06-051-01**

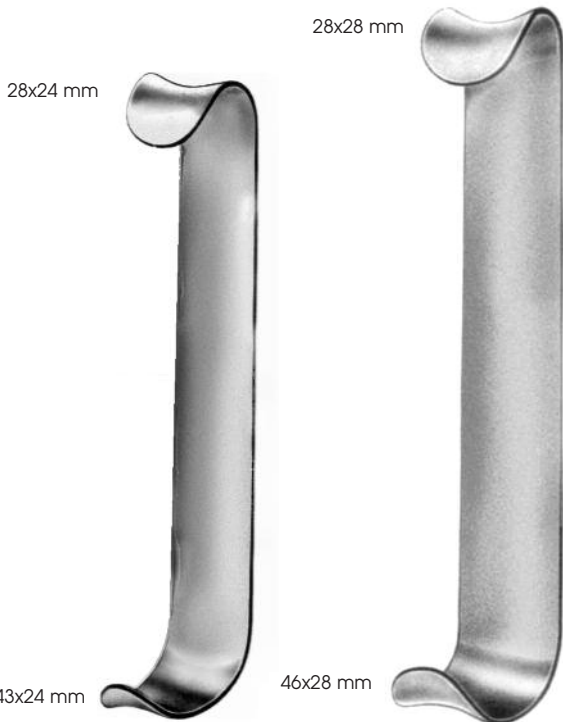

28x24 mm

28x28 mm

43x24 mm

46x28 mm

Roux

17,0 cm **TR-06-051-02**

Roux

19,0 cm **TR-06-051-03**



7x7 mm

6x6 mm

Mini-Roux

14,0 cm **TR-06-052-01**

Fig. 1 24x20 mm
Fig. 2 29x26 mm
Fig. 3 35x39 mm

Fig. 1 30x28 mm
Fig. 2 36x36 mm
Fig. 3 38x43 mm



Roux

Fig. 1 **TR-06-053-01**
Fig. 2 **TR-06-053-02**
Fig. 3 **TR-06-053-03**

Roux

Satz, Set komplett **TR-06-053-00**

Retractors



Fig. 1 26x25 mm
Fig. 2 29x25 mm

TR-06-054-01
TR-06-054-02

Fig. 1 24x25 mm
Fig. 2 27x25 mm

Parker

17,5 cm **TR-06-054-00**

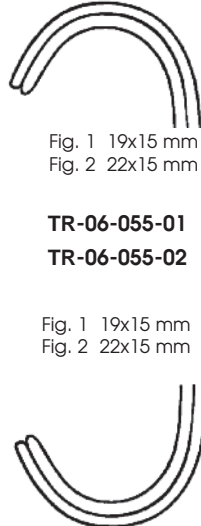

Fig. 1 19x15 mm
Fig. 2 22x15 mm

TR-06-055-01
TR-06-055-02

Fig. 1 19x15 mm
Fig. 2 22x15 mm

Parker-Baby

14,0 cm **TR-06-055-00**

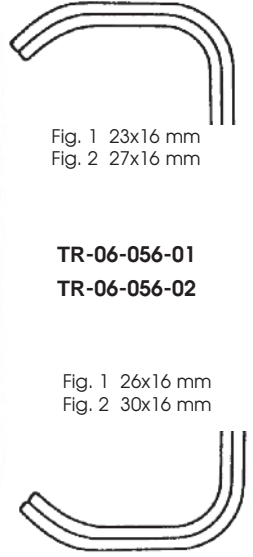

Fig. 1 23x16 mm
Fig. 2 27x16 mm

TR-06-056-01
TR-06-056-02

Fig. 1 26x16 mm
Fig. 2 30x16 mm

Farabeuf

15,0 cm **TR-06-056-00**

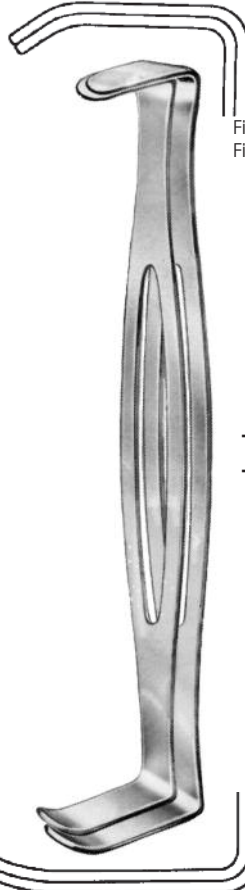

Fig. 1 21x15 mm
Fig. 2 25x15 mm

TR-06-058-01
TR-06-058-02

Fig. 1 40x15 mm
Fig. 2 45x15 mm

Parker-Langenbeck

22,0 cm **TR-06-058-00**

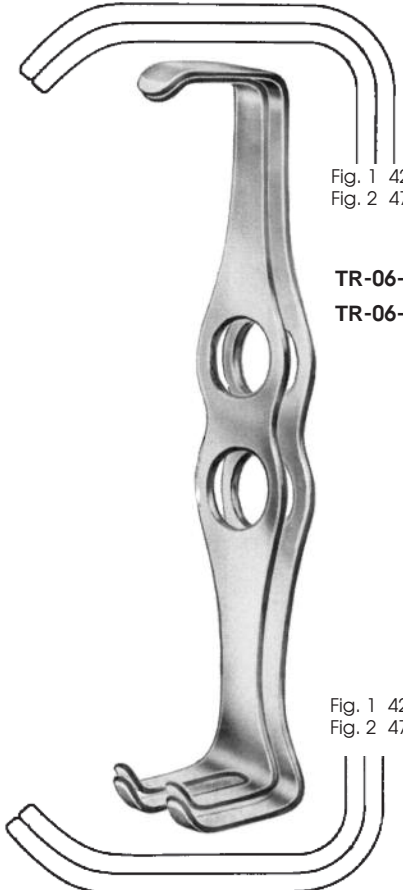

Fig. 1 42x13 mm
Fig. 2 47x13 mm

TR-06-059-01
TR-06-059-02

Fig. 1 42x26 mm
Fig. 2 47x26 mm

Mathieu

21,0 cm **TR-06-059-00**



Fig. 1 26x10 mm
Fig. 2 30x10 mm

TR-06-057-01
TR-06-057-02

Fig. 1 30x13 mm
Fig. 2 34x13 mm

Baby-Farabeuf

12,0 cm **TR-06-057-00**

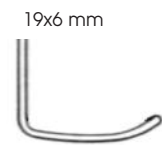

Crile

11,0 cm **TR-06-060-11**

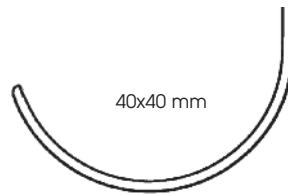
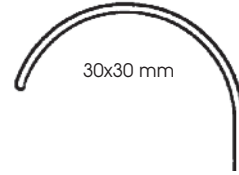

Goelet

19,0 cm **TR-06-061-19**



Luer

11,0 cm **TR-06-062-10**



Rose

13,0 cm **TR-06-062-11**

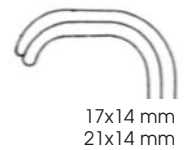

TR-06-063-01
TR-06-063-02

28x16 mm
32x16 mm



Collin

Satz/ Set 15,0 cm **TR-06-063-00**

Abdominal Spatulas



Reverdin
28,0 cm **TR-06-071-28**



flexible

330x20 mm **TR-06-072-01**
330x25 mm **TR-06-072-02**
330x30 mm **TR-06-072-03**
330x40 mm **TR-06-072-04**
330x50 mm **TR-06-072-05**



flexible

Haberer
200x17/25 mm **TR-06-073-01**
280x25/30 mm **TR-06-073-02**
300x37/45 mm **TR-06-073-03**
300x40/50 mm **TR-06-073-04**



flexible, soft

200x 6 mm **TR-06-074-01**
200x 8 mm **TR-06-074-02**
200x10 mm **TR-06-074-03**
200x12 mm **TR-06-074-04**
200x17 mm **TR-06-074-05**
200x25 mm **TR-06-074-06**
250x25 mm **TR-06-074-07**
200x20 mm **TR-06-074-08**



Leriche

25,5 cm **TR-06-076-45** 45 mm
27,5 cm **TR-06-076-60** 60 mm



Kümmel

28,5 cm **TR-06-077-46**

Abdominal Spatulas

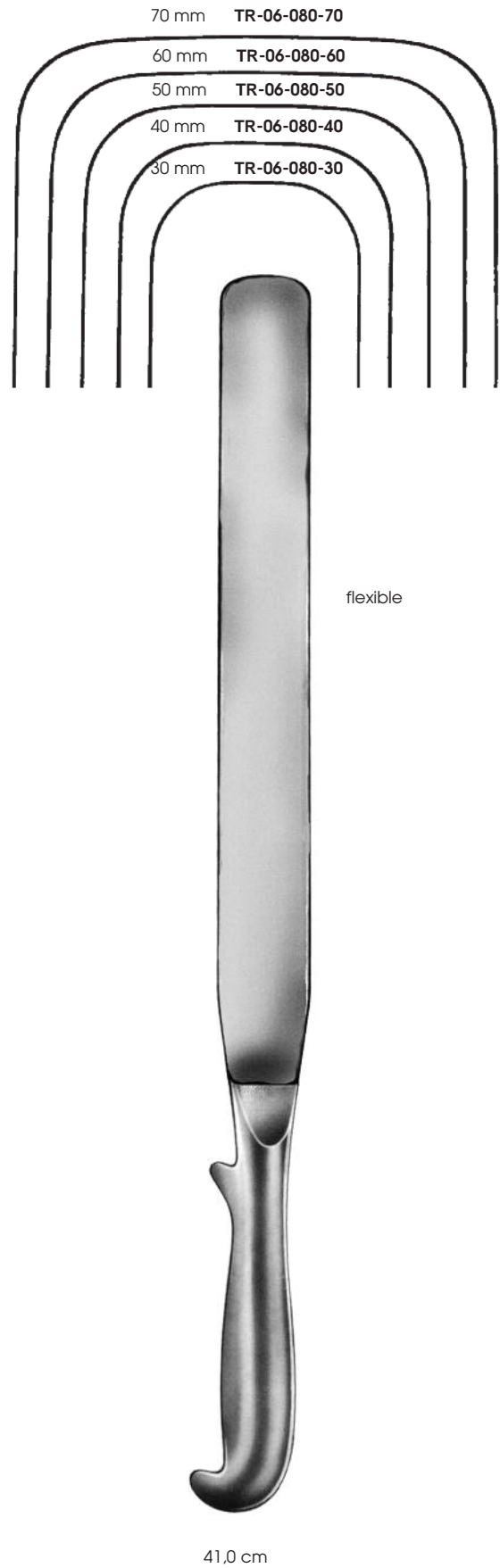
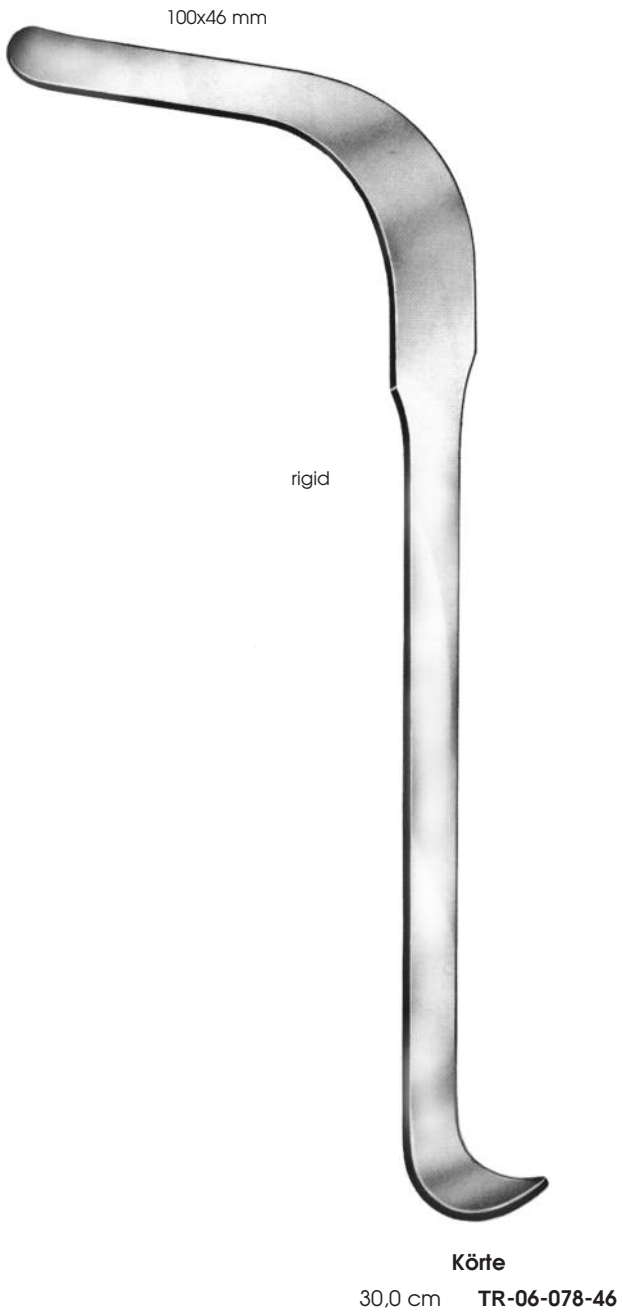



Retractors



Deaver

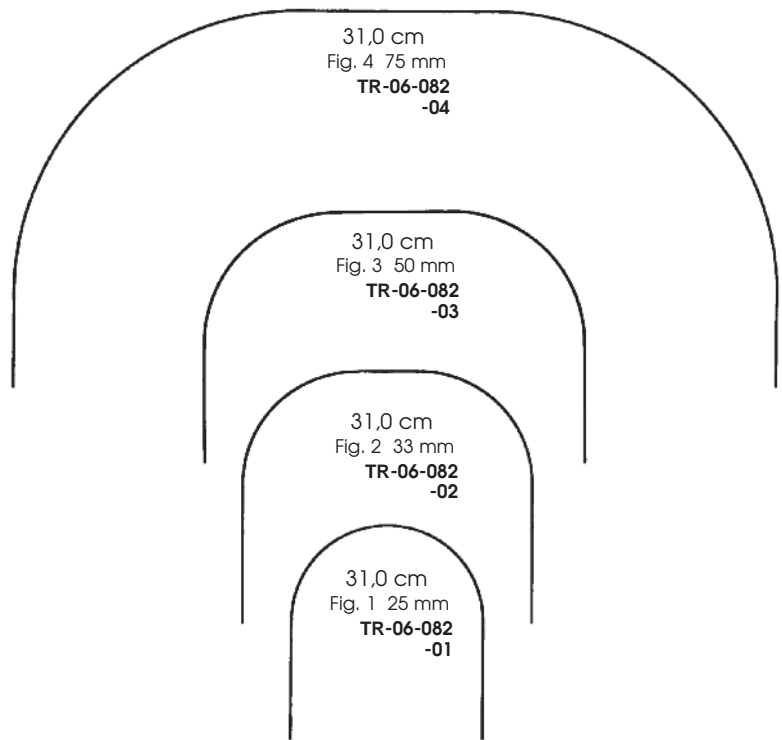

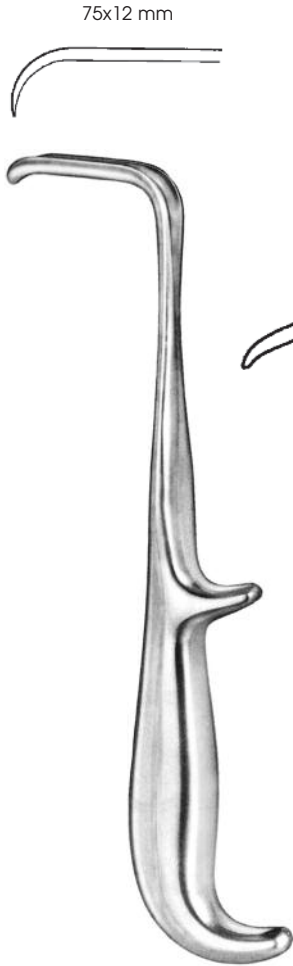

Young
Fig. 1
21.5 cm TR-06-084-01



Young
Fig. 2
21.0 cm TR-06-084-02

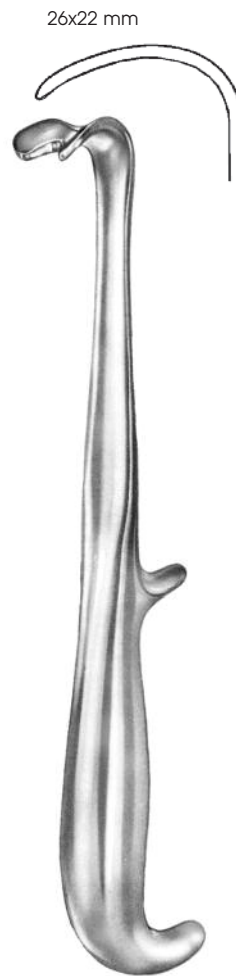

Young
Fig. 3
22.0 cm TR-06-084-03



Young
Fig. 4
21.0 cm TR-06-084-04

Hook and Retractors, fine



Lucae

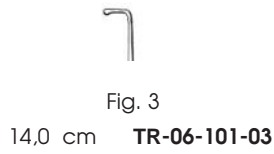
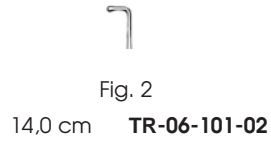
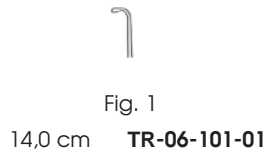

Wagner

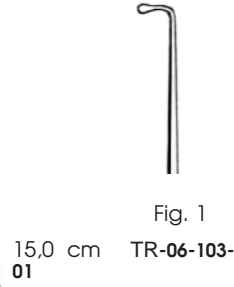

Graefe

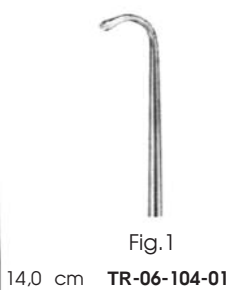

Cushing



Cushing





Crile

20,0 cm **TR-06-107-01**



sharp
16,0 cm **TR-06-108-01**
12,0 cm **TR-06-108-02**



sharp
Fig. 1, 16 cm **TR-06-110-01**
sharp
Fig. 2, 16 cm **TR-06-110-02**



blunt
16,0 cm **TR-06-109-01**
12,0 cm **TR-06-109-02**

sharp
Fig. 3, 16 cm **TR-06-110-03**

sharp
Fig. 4, 16 cm **TR-06-110-04**



16,0 cm **TR-06-111-01**

O'Conner



Guthrie
Fig. 1

TR-06-112-01



Guthrie
Fig. 2

TR-06-112-02



16,0 cm **Spring Hook**

sharp

TR-06-114-01

TR-06-114-02

TR-06-114-03

TR-06-114-04



blunt

TR-06-116-01

TR-06-116-02

TR-06-116-03

TR-06-116-04



wound check
16,0 cm **TR-06-113-02**



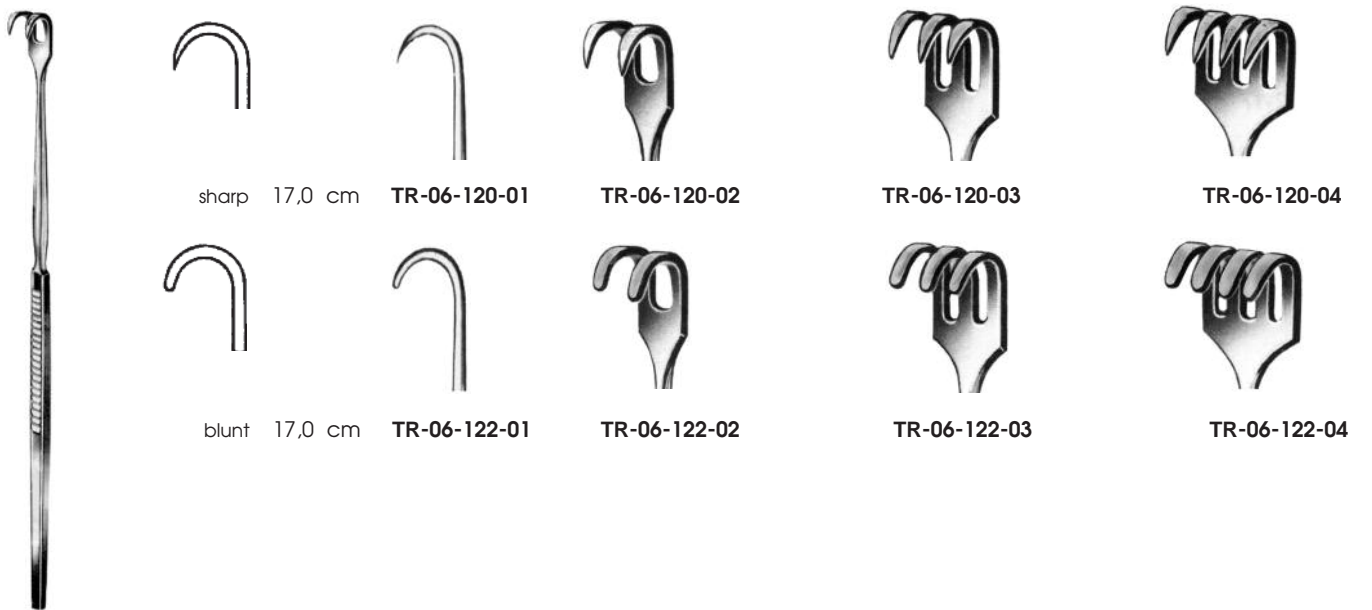
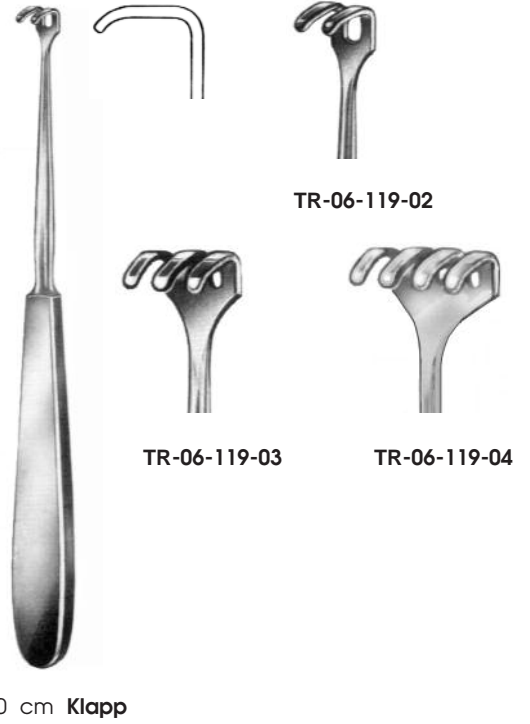
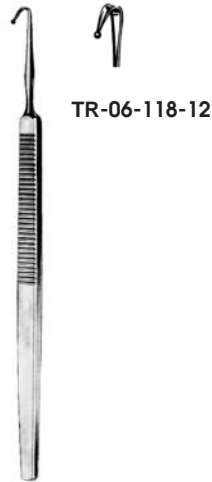
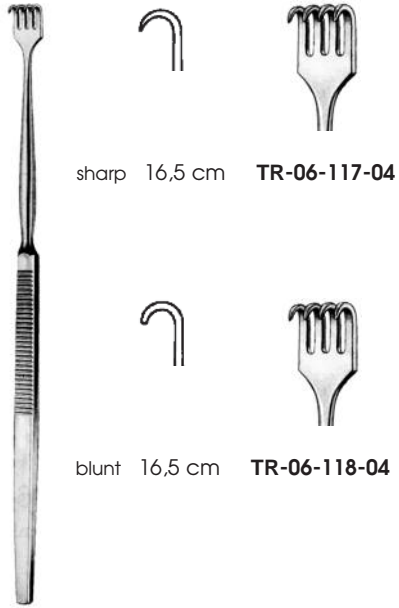











Hook and Retractors, fine



Trachea Retractor









Trachea Retractor

					
sharp	16,5 cm	TR-06-124-01	TR-06-124-02	TR-06-124-03	TR-06-124-04
					
semi sharp	16,5 cm	TR-06-125-01	TR-06-125-02	TR-06-125-03	TR-06-125-04
					
blunt	16,5 cm	TR-06-126-01	TR-06-126-02	TR-06-126-03	TR-06-126-04



Desmarres

				
	13,0 cm 16,0 cm	8,0 mm TR-06-127-08 TR-06-128-08	10,0 mm TR-06-127-10 TR-06-128-10	12,0 mm TR-06-127-12 TR-06-128-10
				
	13,0 cm 16,0 cm	14,0 mm TR-06-127-14 TR-06-128-14	16,0 mm TR-06-127-16 TR-06-128-16	18,0 mm TR-06-127-18 TR-06-128-18

Hook and Retractors, fine



Desmarres

12,0 mm
13,0 cm **TR-06-129-12**
16,0 cm **TR-06-130-12**

16,0 mm
13,0 cm **TR-06-129-16**
16,0 cm **TR-06-130-16**

14,0 mm
TR-06-129-14
TR-06-130-14

18,0 mm
TR-06-129-18
TR-06-130-18

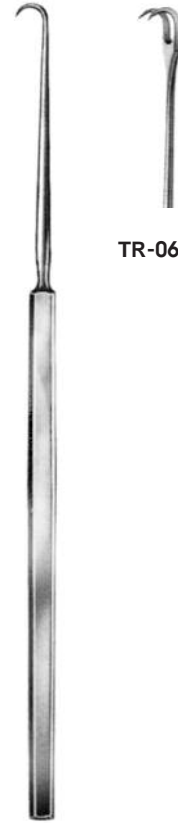

TR-06-131-03

Simon
22,0 cm **TR-06-131-02**



König, 18,0 cm

13x13 mm
TR-06-132-01

12x16 mm
TR-06-132-02



Cushing

8,0 mm
20,0 cm **TR-06-133-08**
24,0 cm **TR-06-134-08**

12,0 mm
20,0 cm **TR-06-133-12**
24,0 cm **TR-06-134-12**

16,0 mm
20,0 cm **TR-06-133-16**
24,0 cm **TR-06-134-16**

10,0 mm
TR-06-133-10
TR-06-134-10

14,0 mm
TR-06-133-14
TR-06-134-14

18,0 mm
TR-06-133-18
TR-06-134-18

Hook and Retractors, fine



Cushing-Kocher
18,0 cm TR-06-135-10



Gil-Vernet, 24,0 cm



8,0 mm
TR-06-136-08



11,0 mm
TR-06-136-11



13,0 mm
TR-06-136-13



15,0 mm
TR-06-136-15



17,0 mm
TR-06-136-17



20,0 mm
TR-06-136-20



23,0 mm
TR-06-136-23



10x6 mm
TR-06-138-10



20x6 mm
TR-06-138-20

Senn-Green, 15,0 cm



8x7 mm
TR-06-139-01

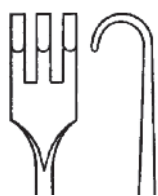

8x7 mm
TR-06-139-02

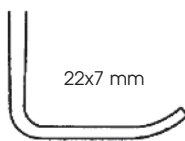

22x7 mm

Senn-Miller, 14,0 cm



Langenbeck, 16,0 cm



10x6 mm
TR-06-140-10



17x5 mm
TR-06-140-17



20x6 mm
TR-06-140-20



22x8 mm
TR-06-140-22

Hook and Retractors, fine



Ragnell-Davis
15,0 cm TR-06-142-14

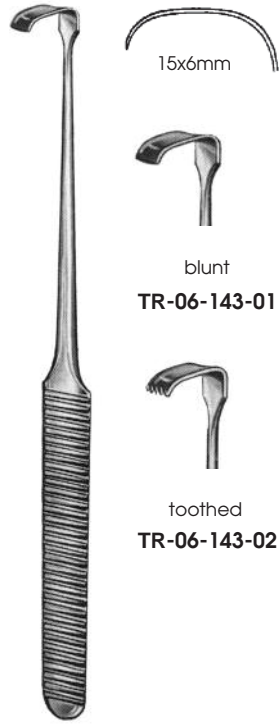

Strandell-Stille, 18,0 cm

15x6mm



blunt
TR-06-143-01



toothed
TR-06-143-02



Cushing
20,0 cm TR-06-144-20



Kilner
16,0 cm TR-06-150-16

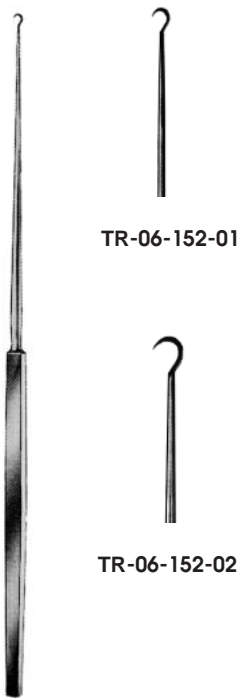

Gillies, 18,0 cm

TR-06-152-01

TR-06-152-02

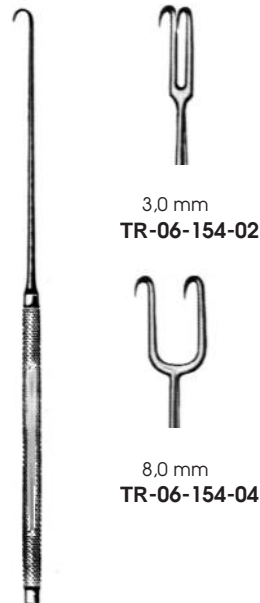

Joseph
TR-06-154-01, 16,0 cm

3,0 mm
TR-06-154-02

8,0 mm
TR-06-154-04



6,0 mm
TR-06-154-03



10,0 mm
TR-06-154-05



Freer
15,0 cm TR-06-156-15



Cushing, 25,0 cm



11x14 mm
TR-06-160-14



17x18 mm
TR-06-160-18



15x22 mm
TR-06-160-22



Paul
12,0 cm **TR-06-162-12**



Brom, 19,0 cm



Fig.1
TR-06-164-01



Fig.2
TR-06-164-02



Fig.1 13x13 mm
TR-06-170-01



Fig. 2 14x12 mm
TR-06-170-02



Fig. 3 18x18 mm
TR-06-170-03



Fig. 4 20x20 mm
TR-06-170-04



Fig. 5 22x18 mm
TR-06-170-05

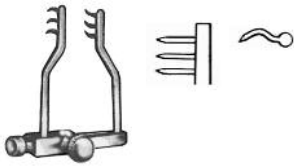

Fig. 6 26x24 mm
TR-06-170-06



Ross, 25,0 cm

Retractors



Logan
4,0 cm TR-06-201-03



Finsen

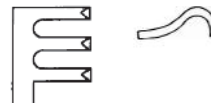

sharp
5,0 cm TR-06-203-05

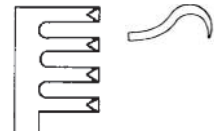

sharp
7,0 cm TR-06-203-07

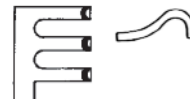

blunt
5,0 cm TR-06-204-05

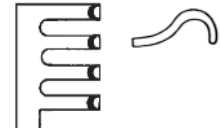

blunt
7,0 cm TR-06-204-07



Finsen

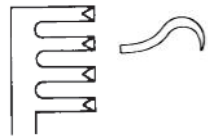

sharp
7,0 cm TR-06-206-07

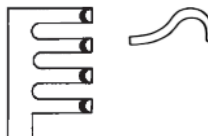

blunt
7,0 cm TR-06-207-07



Holzheimer
10,0 cm TR-06-210-10



Alm

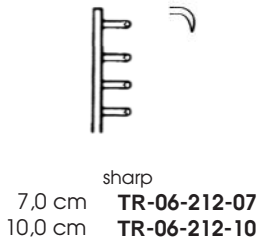

sharp
7,0 cm TR-06-212-07
10,0 cm TR-06-212-10

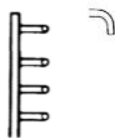

blunt
7,0 cm TR-06-213-07
10,0 cm TR-06-213-10



Jansen



sharp
9,5 cm TR-06-214-06

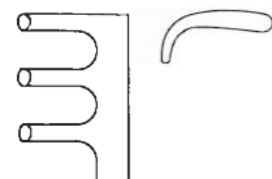

blunt
9,5 cm TR-06-215-06



Scalp-Contour, 14,0 cm

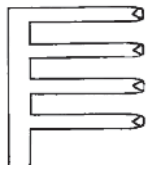

sharp
TR-06-216-14

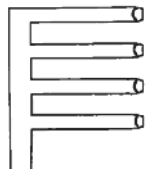

blunt
TR-06-216-15

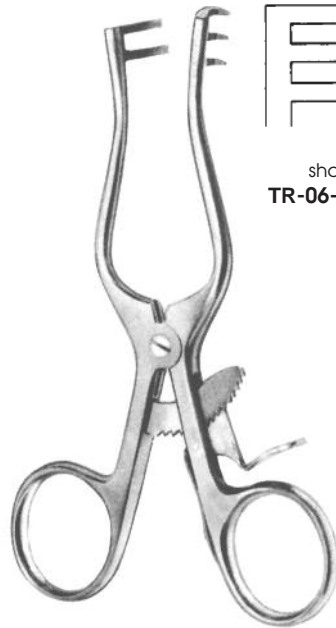

Weitlaner, 10,5 cm

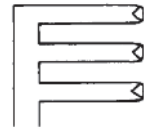

sharp
TR-06-217-10

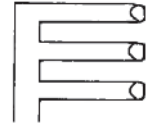

blunt
TR-06-218-10



Weitlaner

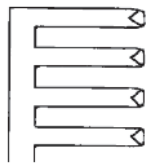

sharp
13,5 cm TR-06-217-13
16,5 cm TR-06-217-16

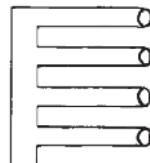

blunt
13,5 cm TR-06-218-13
16,5 cm TR-06-218-16

Retractors

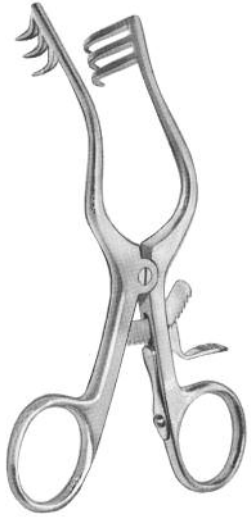

Weitlaner-Wullstein, 13,0 cm

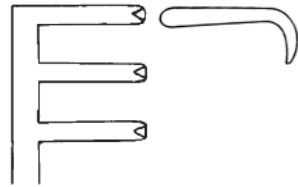

sharp
TR-06-219-13

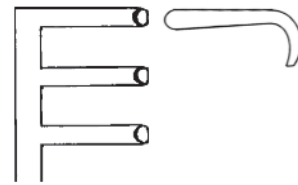

blunt
TR-06-220-13



Mollison, 15,0 cm

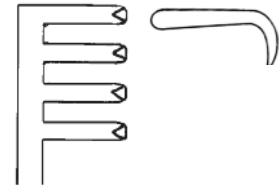

sharp
TR-06-221-15



Plester, 13,0 cm

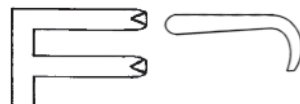

sharp
TR-06-222-13

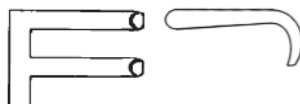

blunt
TR-06-223-13



Plester, 11,0 cm
left blunt

TR-06-224-11

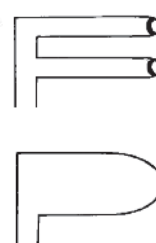

Plester 11,0 cm
right blunt
TR-06-225-11

Retractors



Milligan, 13,0 cm

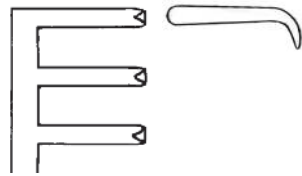

sharp
TR-06-227-13

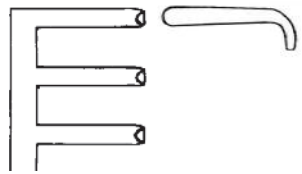

blunt
TR-06-228-13

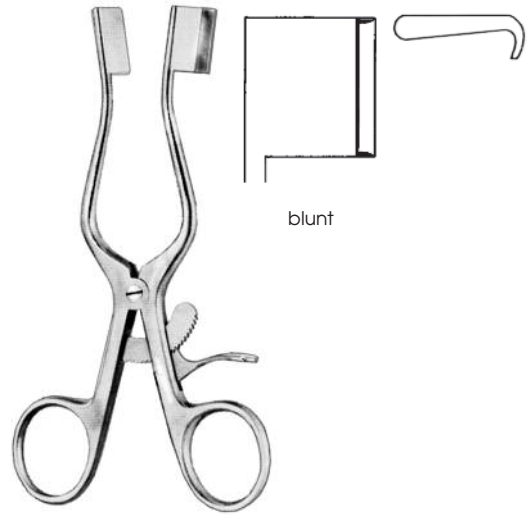

Weitlaner-Baby
13,0 cm **TR-06-230-13**



blunt



Tübinger Modell
16,5 cm **TR-06-231-16**

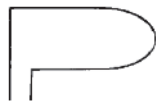

Henley, 16,5 cm

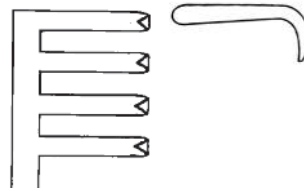

sharp
TR-06-234-00

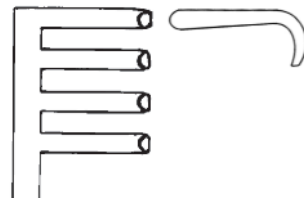

blunt
TR-06-235-00

- 16x19 mm **TR-06-236-19**
- 16x25 mm **TR-06-236-25**
- 16x32 mm **TR-06-236-32**

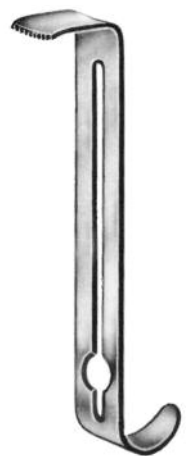

Henley Mittelvalve

Retractors



Anderson-Adson, 19,0 cm

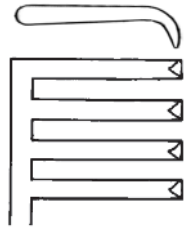

sharp
TR-06-241-20

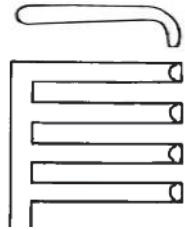

blunt
TR-06-242-20

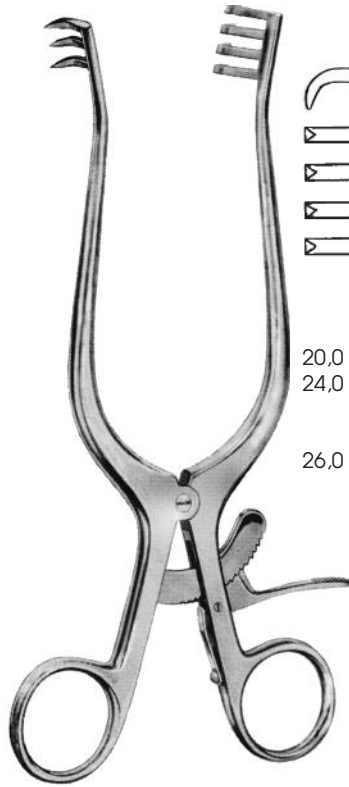

Weitlaner

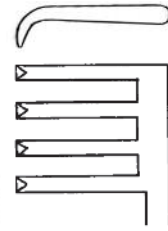

3:4 sharp
20,0 cm **TR-06-243-20**
24,0 cm **TR-06-243-24**

5:6 sharp
26,0 cm **TR-06-243-26**

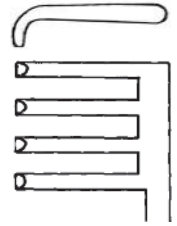

3:4 blunt
20,0 cm **TR-06-244-20**
24,0 cm **TR-06-244-24**

5:6 blunt
26,0 cm **TR-06-244-26**



Adson, 26,5 cm

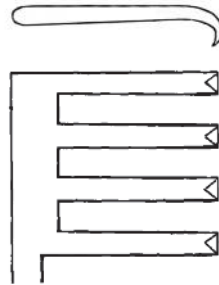

3:4 sharp
TR-06-246-07

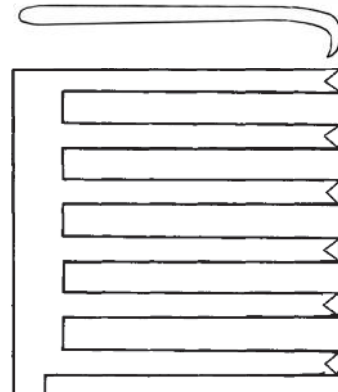

5:6 sharp
TR-06-246-12

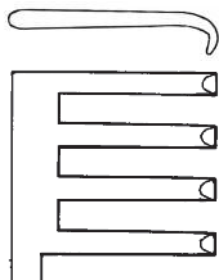

3:4 blunt
TR-06-247-07

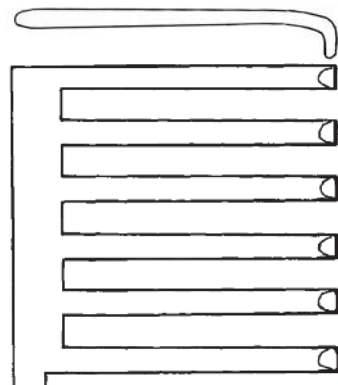

5:6 blunt
TR-06-247-12



Gelpi-Loktite
13,0 cm TR-06-248-13



Gelpi-Loktite
18,0 cm TR-06-248-18



Gelpi-Loktite
18,0 cm TR-06-249-18



Gelpi-Seiletz
15,0 cm TR-06-250-15

Retractors



Adson

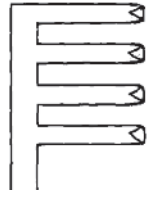

sharp
13,0 cm **TR-06-252-13**
16,0 cm **TR-06-252-16**

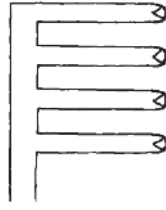

sharp
20,0 cm **TR-06-252-20**

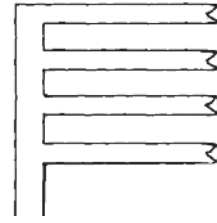

sharp
26,0 cm **TR-06-252-26**

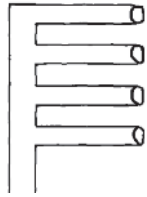

blunt
13,0 cm **TR-06-253-13**
16,0 cm **TR-06-253-16**

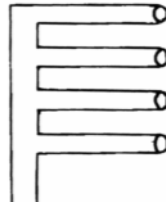

blunt
20,0 cm **TR-06-253-20**

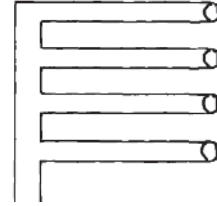

blunt
26,0 cm **TR-06-253-26**

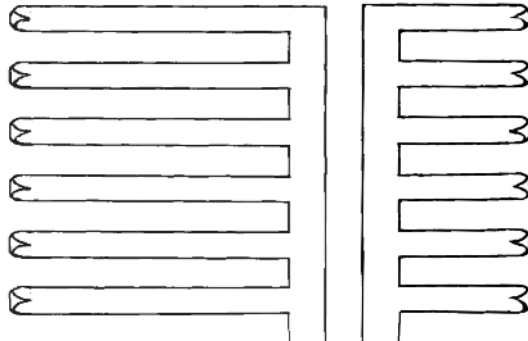

sharp
left long **TR-06-254-01**
right long **TR-06-254-02**



Adson, 27,0 cm



Beckmann, 31,0 cm

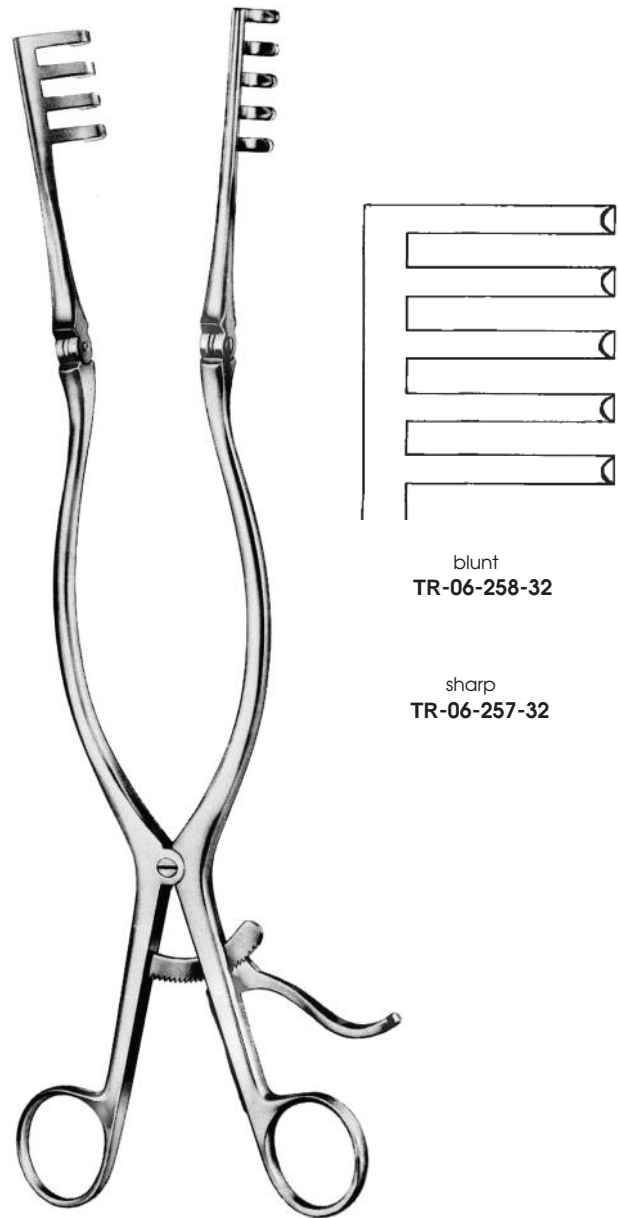

Beckmann-Adson, 32,0 cm

Retractors



Beckmann-Adson, 31,0 cm

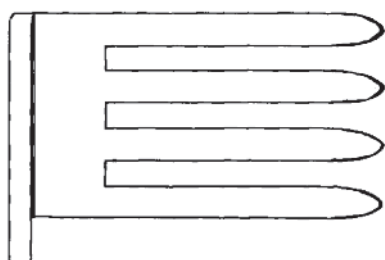

sharp
TR-06-259-01

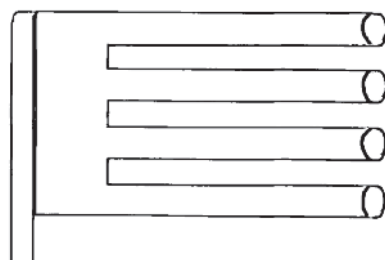

blunt
TR-06-259-02

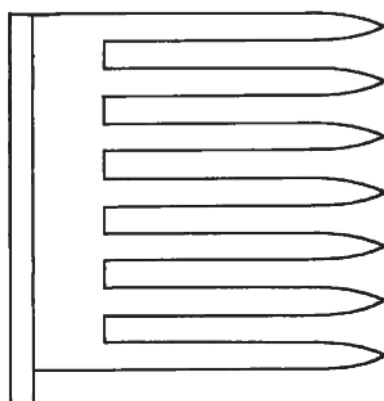

sharp
TR-06-261-32



Beckmann-Eaton, 32,0 cm

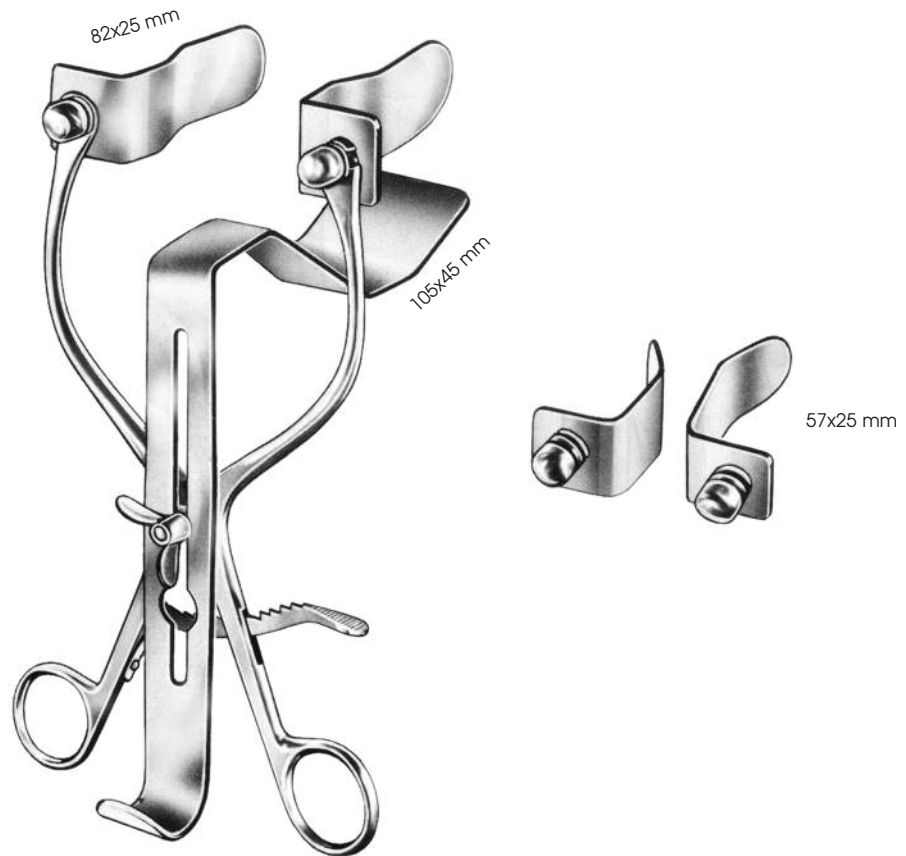

Millin
TR-06-265-01

with 5 blades

Millin
TR-06-265-02

with 5 blades and Fiber optic light carrier

Spreader, only

TR-06-265-10

Blades(pair)

TR-06-265-11 57x25 mm

TR-06-265-12 82x25 mm

Centerblades

TR-06-265-13 105x45 mm

Abdominal Retractors

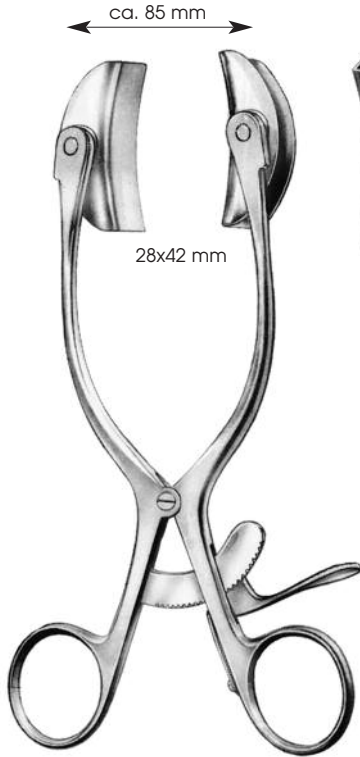

Baby-Collin
TR-06-267-00

with 2 pairs of blades

Spreader,only TR-06-267-01

blades(pair) TR-06-267-02 18x42 mm
TR-06-267-03 28x42 mm



Collin
TR-06-268-00

with 1 pair of blades

Spreader,only TR-06-268-01

Blades(pair) TR-06-268-02 37x62 mm

Abdominal Retractors

Laterale and center blades

Laterale blades

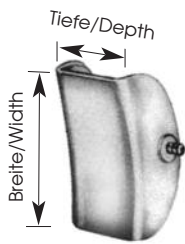

Center blades

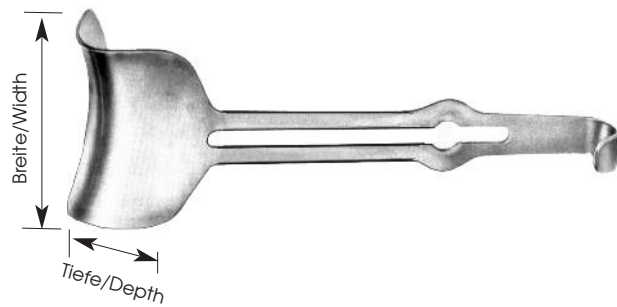

depth x width	pair	depth x width	
18 x 42 mm	TR-06-267-02	38 x 55 mm	TR-06-269-02
28 x 42 mm	TR-06-267-03	54 x 55 mm	TR-06-269-03
37 x 62 mm	TR-06-268-02	54 x 67 mm	TR-06-270-06
37 x 80 mm	TR-06-270-04	63 x 74 mm	TR-06-270-09
37 x 98 mm	TR-06-270-05		
46 x 59 mm	TR-06-270-07		
61 x 80 mm	TR-06-270-08		

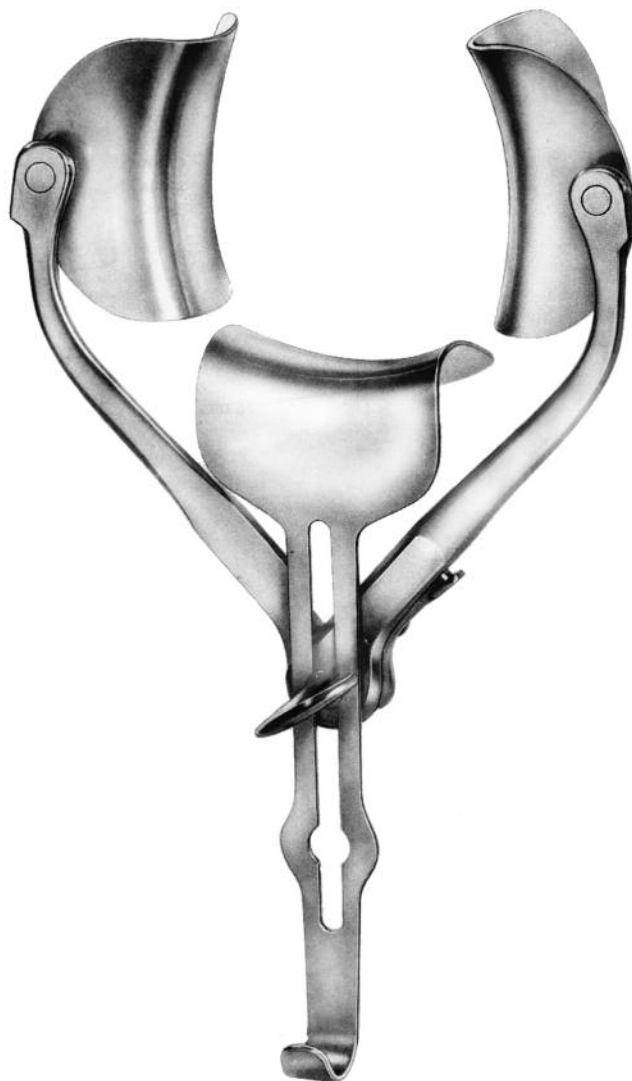

Ricard

Spreader, complete	TR-06-272-00	TR-06-273-00
Spreader, only	TR-06-272-01	TR-06-272-01
Blades, pair	TR-06-272-02 58x80 mm	TR-06-272-03 72x85 mm
Centerblade	TR-06-272-04 54x70mm	TR-06-272-05 72x90 mm

Abdominal Retractors

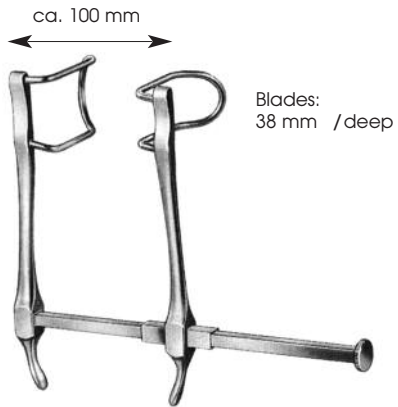

Gosset
Fig. 1
TR-06-274-10

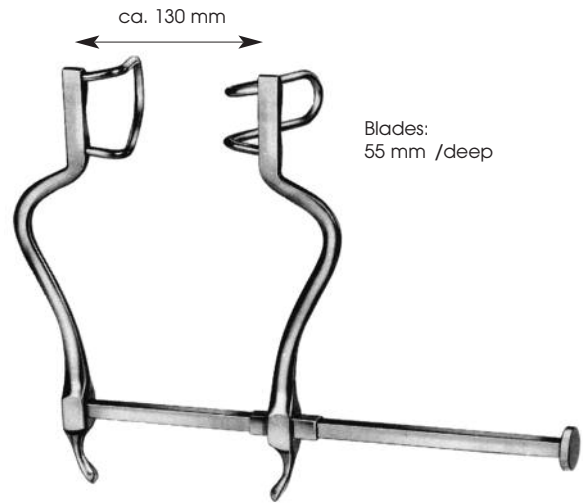

Gosset
Fig. 2
TR-06-274-14



Gosset
Fig.3
06-275-16



Lateral blades:
27 mm /deep

Center blade
22x20 mm

TR-06-280-04

Balfour-Baby
06-276-00
complete

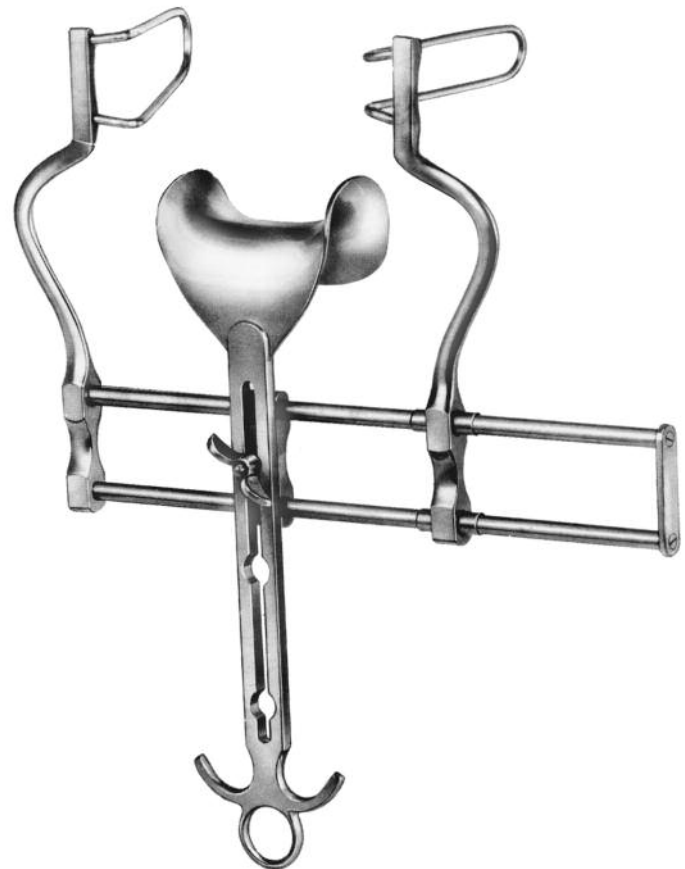

TR-06-277-18, Fig. 1

Lateral blades:
65 mm /deep

Center blade
45x80 mm

TR-06-280-01

TR-06-277-20, Fig. 2

Lateral blades:
100 mm /deep

Center blade
102x60 mm

TR-06-280-03

TR-06-277-25, Fig. 3

Lateral blades:
100 mm /deep

Center blade
70x80 mm

TR-06-280-02

Balfour

TR-06-277-18 Fig. 1

TR-06-277-20 Fig. 2

TR-06-277-25 Fig. 3

Abdominal Retractors

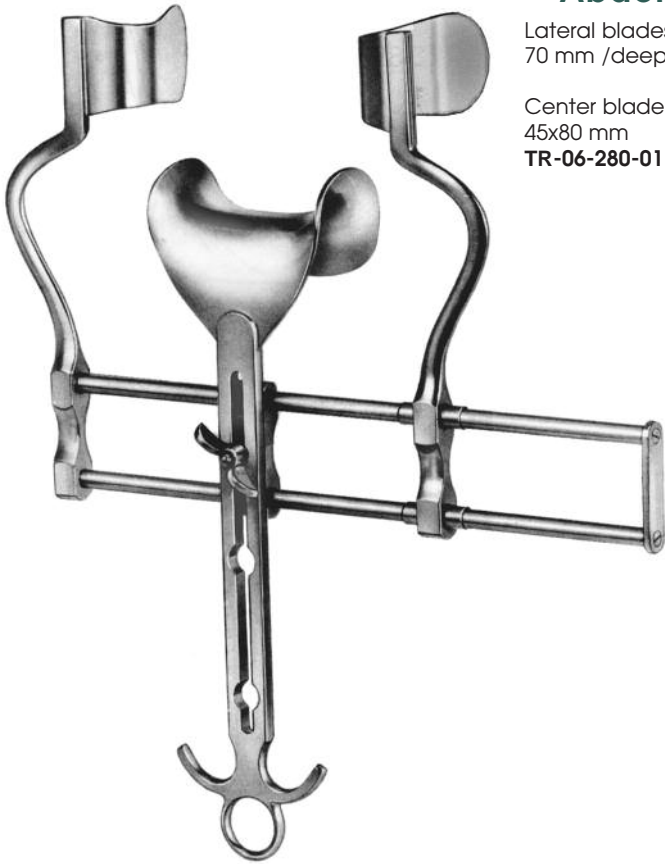

Lateral blades:
70 mm /deep

Center blade
45x80 mm
TR-06-280-01

Balfour
06-278-18



Lateral blades:
70 mm /deep

Center blade
70x80 mm
TR-06-280-02

Balfour, US-Modell
TR-06-279-00



Balfour
TR-06-280-01 45x80 mm
TR-06-280-02 70x80 mm

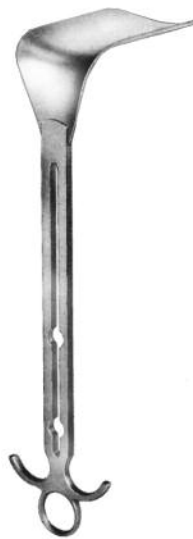

Balfour
TR-06-280-03 100x60 mm

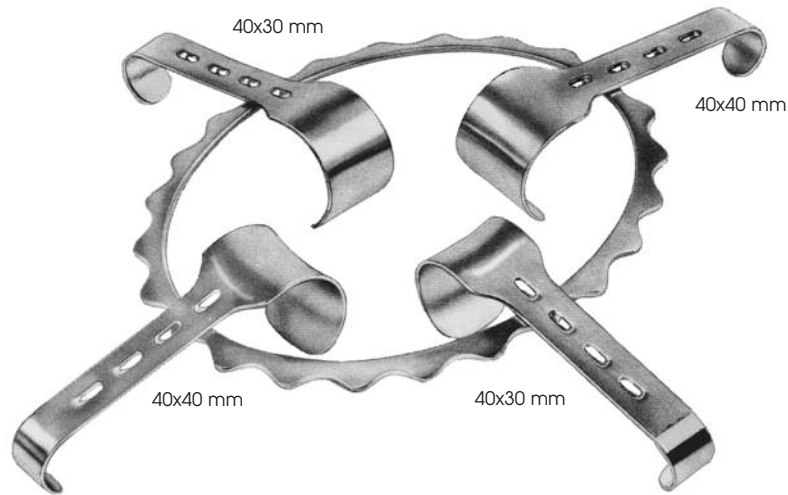

Dennis-Browne, /complete
TR-06-281-00

consisting of:

Frame, only	TR-06-281-15	175x150 mm
2 Blades	TR-06-281-30	40x30 mm
2 Blades	TR-06-281-40	40x40 mm

consisting of:

Frame, only	TR-06-282-01	
2 Blades	TR-06-282-02	80x45 mm
1 Blade	TR-06-282-03	110x70 mm

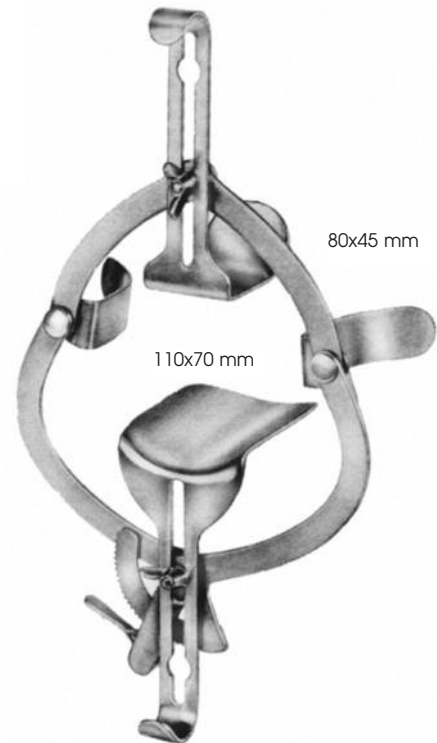

O'Sullivan-O'Connor
complete
TR-06-282-00

Abdominal Retractors

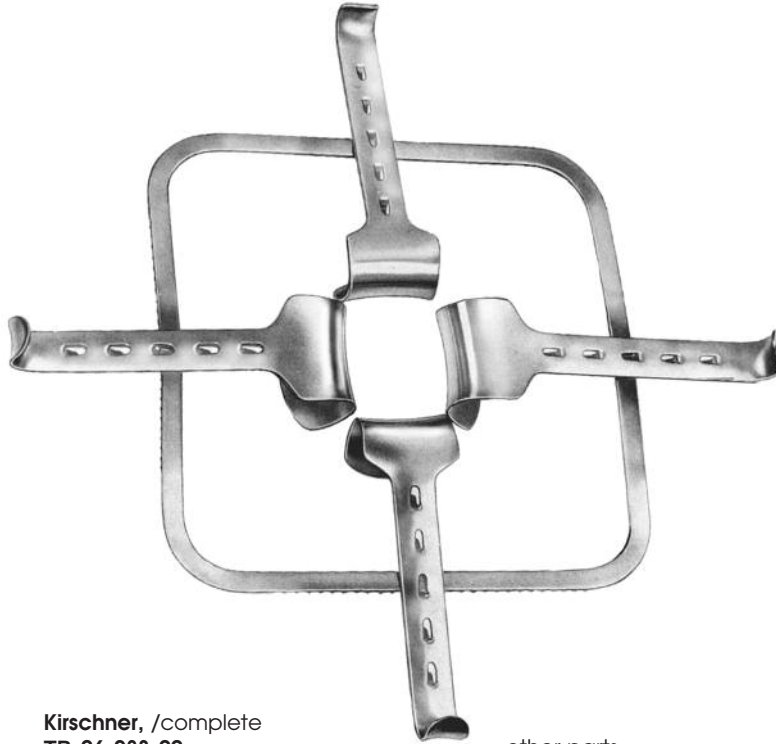

Kirschner, /complete
TR-06-283-00

consisting of:

- Frame,only** **TR-06-283-24** 240x240 mm
- 2 Blades** **TR-06-283-40** 40x55 mm
- 2 Blades** **TR-06-283-50** 50x65 mm

other parts:

- Frame,only** **TR-06-283-26** 260x300 mm
- Frame,only** **TR-06-283-36** 260x360 mm
- 1 Blade** **TR-06-283-60** 60x85 mm
- TR-06-283-78** 78x65 mm
- TR-06-283-80** 80x90 mm
- TR-06-283-98** 98x50 mm
- TR-06-283-99** 105x35 mm

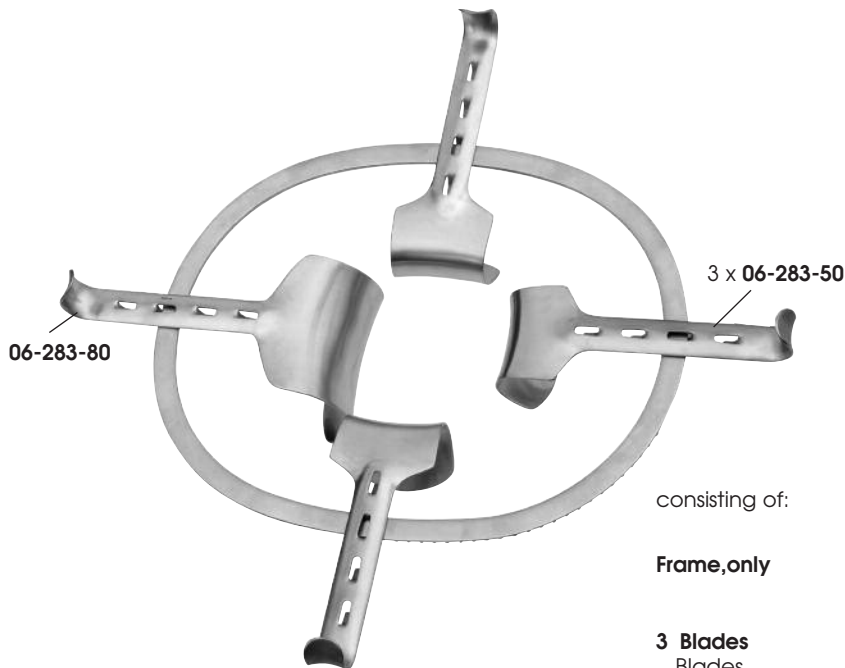

Kirschner, oval
complete
06-284-00

consisting of:

- Frame,only** **TR-06-284-30** 300x240 mm
- 3 Blades** **TR-06-283-50** 50x65 mm
- Blades**
- each 1blade** **TR-06-283-80** 80x90 mm
- TR-06-283-98** 98x50 mm
- TR-06-283-99** 105x35 mm



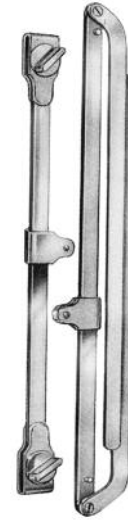
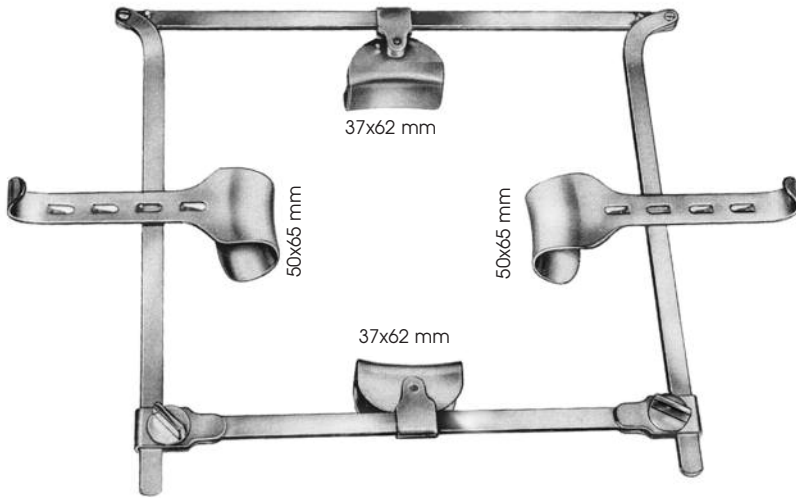

Franz
complete
TR-06-286-00

consisting of:

Frame,only **TR-06-286-01** 220x220 mm

2 Blades **TR-06-268-02** 37x62 mm

2 Blades **TR-06-283-50** 50x65 mm

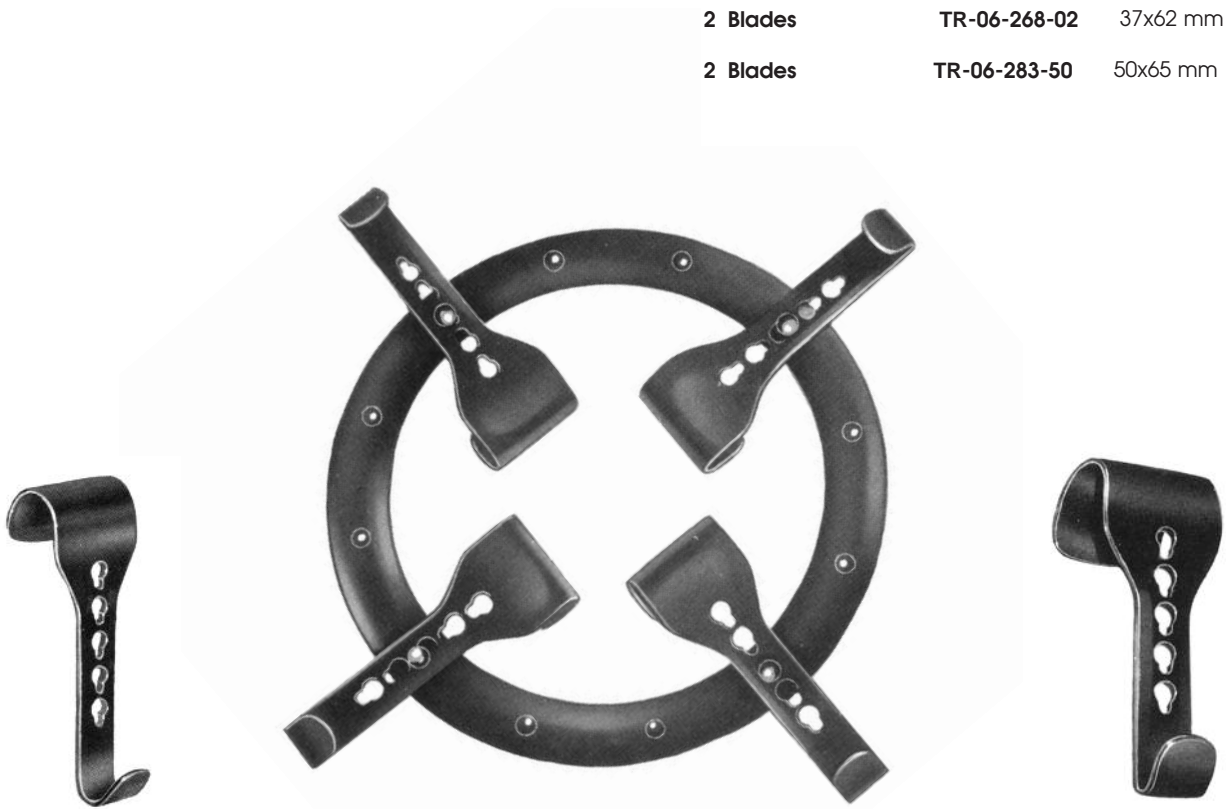

Blade
TR-06-298-05
50x65 mm

Abdominal retractor/x-ray, complete
TR-06-298-00
consisting of:

Frame,only **TR-06-298-25**

4 Blades **TR-06-298-0**

Blade
TR-06-298-07
75x65 mm

Abdominal Retractors

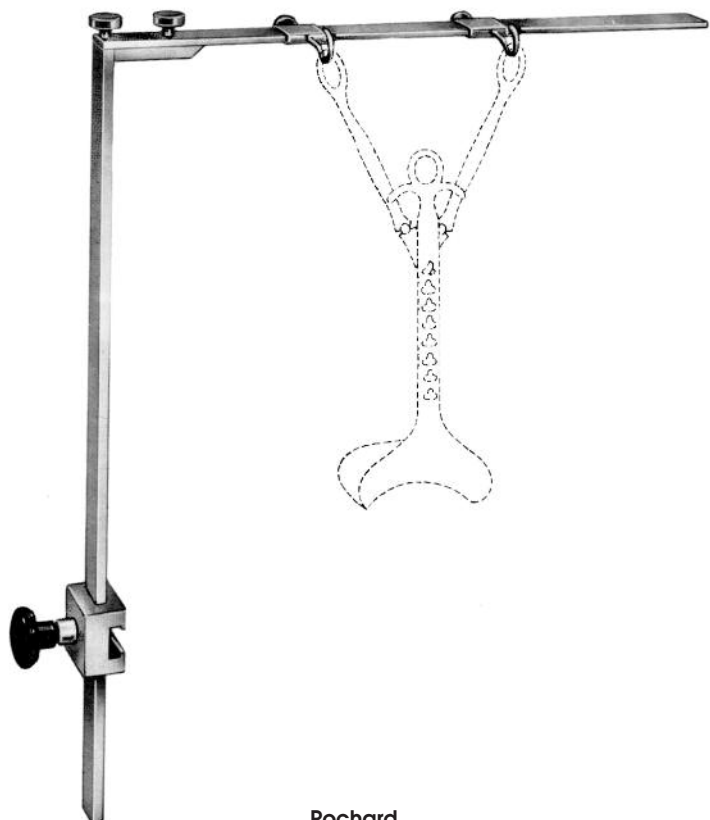

Rochard
TR-06-300-01



Rochard

- TR-06-300-09** 50x95 mm
- TR-06-300-10** 50x105 mm
- TR-06-300-12** 50x120 mm
- TR-06-300-13** 50x135 mm
- TR-06-300-15** 50x155 mm



Fixation device
TR-06-300-05



Rochard
TR-06-300-02

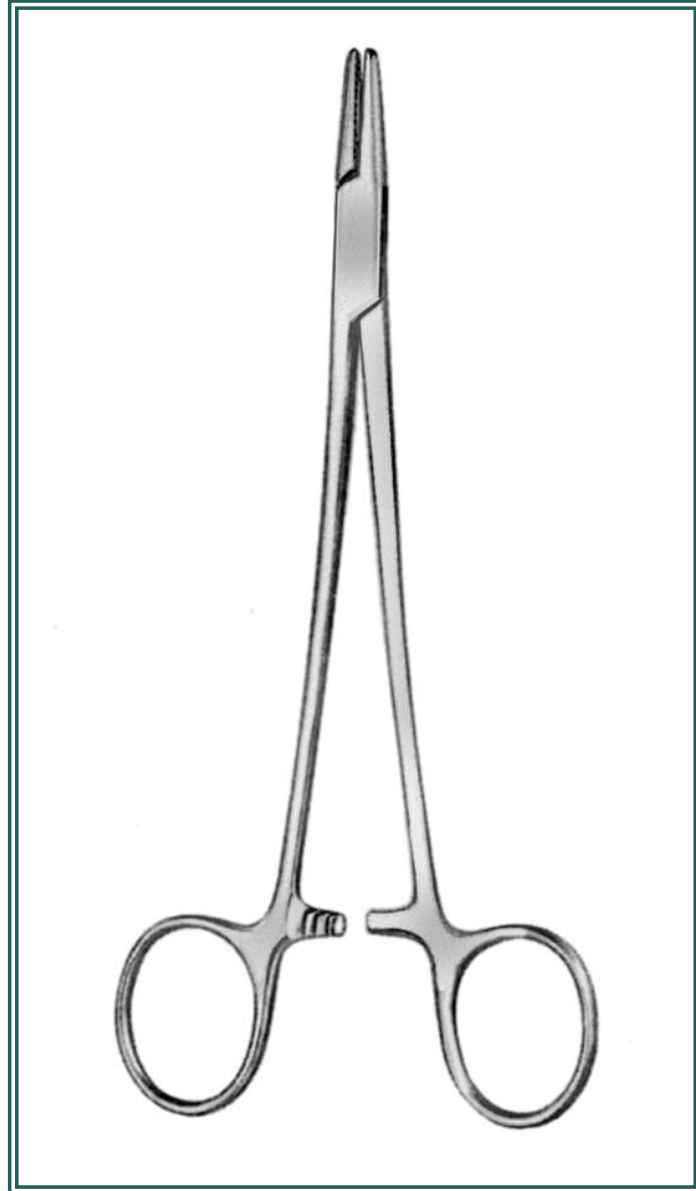

07

Needle Holders, Suture Instruments

Needle Holders



Mayo-Hegar

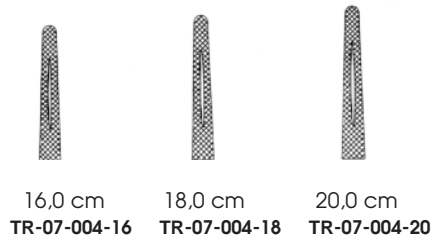
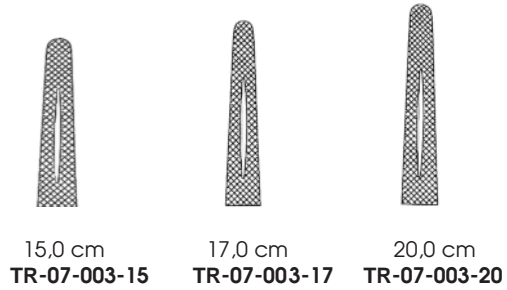
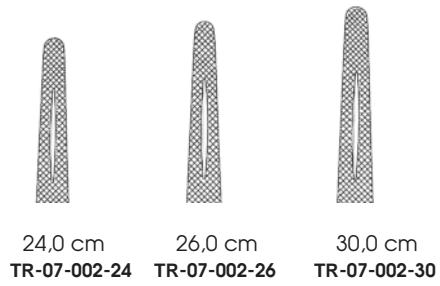
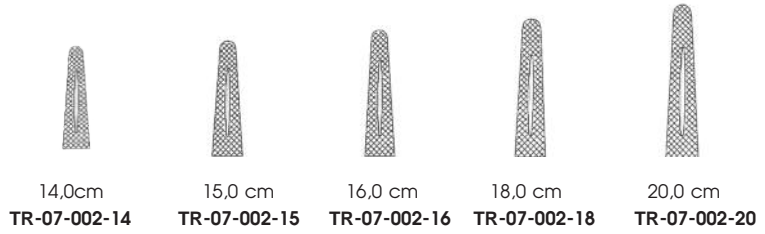

normal

heavy

delicate

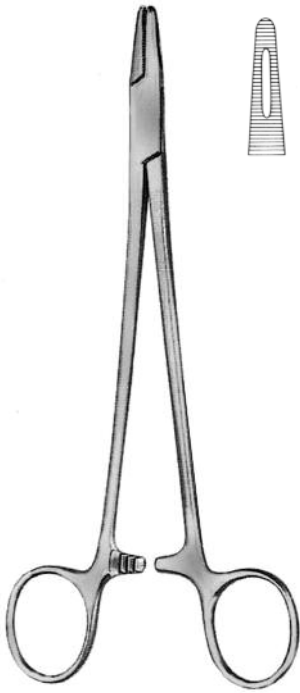

Adson
18,0 cm TR-07-008-18



15,0 cm TR-07-012-15
18,0 cm TR-07-012-18
20,0 cm TR-07-012-20

Crile-Murray



Crile-Wood
15,0 cm TR-07-014-15



18,0 cm TR-07-020-18
26,0 cm TR-07-020-26

Sarot



Hegar-Baumgartner
14,0 cm TR-07-022-14

Needle Holders



TR-07-026-13



TR-07-030-13

Halsey, 13,0 cm



Webster

13,0 cm TR-07-028-13



Derf

12,0 cm TR-07-032-12



Derf, Converse

12,0 cm TR-07-034-12



Collier

12,0 cm TR-07-036-12



Heaney

21,0 cm TR-07-037-21



Bozemann

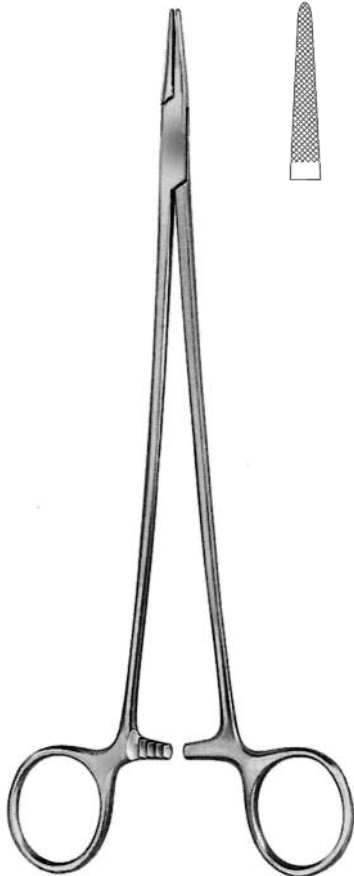

Jameson
23,0 cm TR-07-040-23

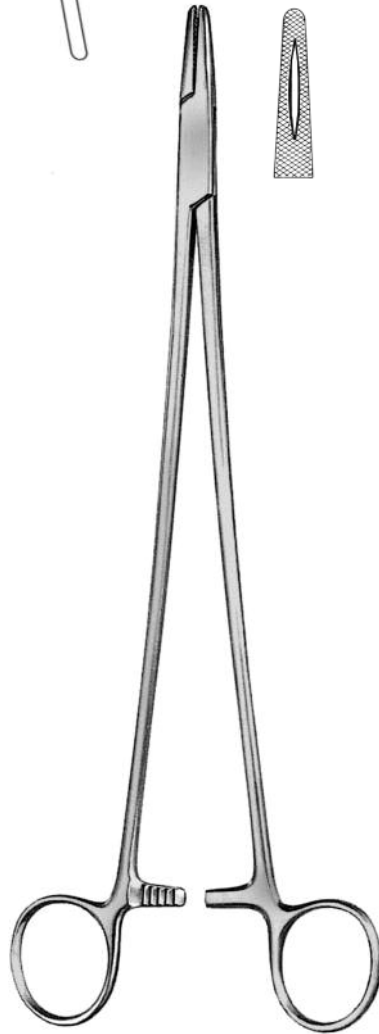

Masson
27,0 cm TR-07-042-27

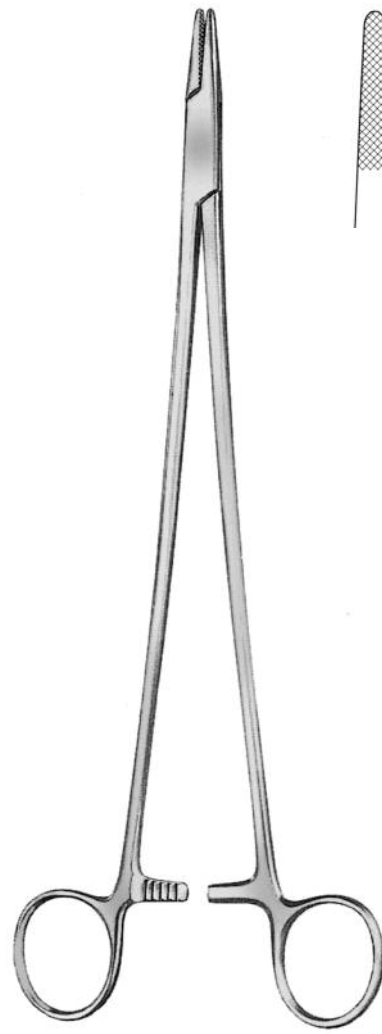
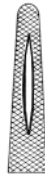

Wangenstein
27,0 cm TR-07-044-27



Needle Holders



Finocchietto
27,0 cm TR-07-045-27



14,0 cm
TR-07-048-14



18,0 cm
TR-07-048-18



Gillies
16,0 cm TR-07-049-16



Arruga, 16,0 cm

TR-07-050-16



TR-07-051-16



Mathieu

14,0 cm
TR-07-052-14



17,0 cm
TR-07-052-17



20,0 cm
TR-07-052-20



Mathieu

14,0 cm
TR-07-054-14



17,0 cm
TR-07-054-17



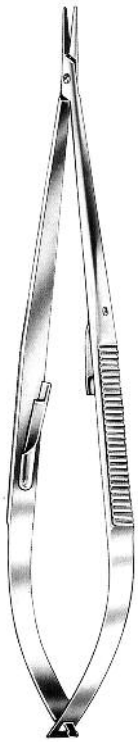

Jacobson, 18,0 cm

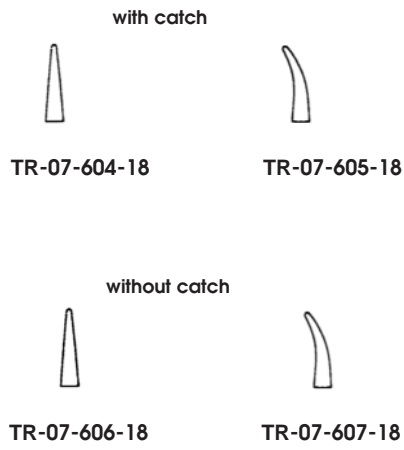

16,0 cm
Micro Needle Holder

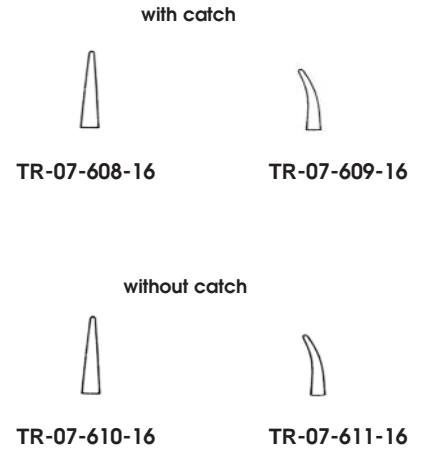

Castroviejo, 14,0 cm

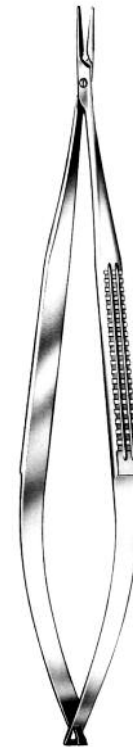

18,0 cm
Micro Needle Holder



Micro Needle Holders

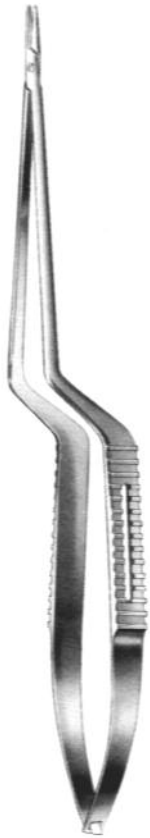

23,0 cm	TR-07-630-23	TR-07-631-23
19,0 cm	TR-07-632-19	TR-07-633-19
16,0 cm	TR-07-634-16	TR-07-635-16





22,5 cm	TR-07-642-22	TR-07-643-22
20,0 cm	TR-07-644-20	TR-07-645-20
16,5 cm	TR-07-646-16	TR-07-647-16



Micro Needle Holder, bayonet



Yasargil



	
TR-07-306-12	TR-07-307-12
with catch	
TR-07-304-12	TR-07-305-12
without catch	



12,0 cm
Micro Needle Holder



	
TR-07-328-15	TR-07-329-15
with catch	
TR-07-326-15	TR-07-327-15
without catch	

15,0 cm
Micro Needle Holder



	
TR-07-328-18	TR-07-329-18
with catch	
TR-07-326-18	TR-07-327-18
without catch	

18,0 cm
Micro Needle Holder



Reverdin, 15,0 cm



Fig. 1
TR-07-701-15



Fig. 2
TR-07-703-15



Fig. 3
TR-07-705-15



Fig. 4
TR-07-707-15



Reverdin



Fig. 1
TR-07-701-19



Fig. 2
TR-07-703-19

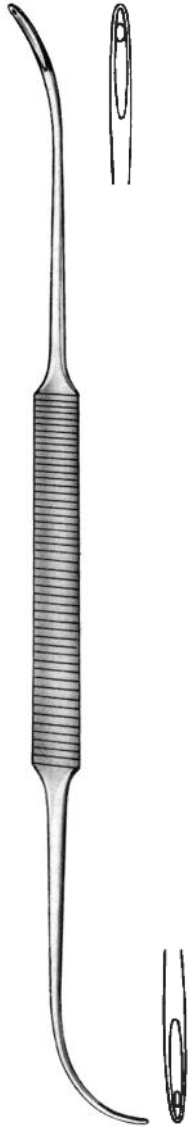

Fig. 3
TR-07-705-19



Fig. 4
TR-07-707-19

Ligature Needles



Schmieden-Dick
flexible
30,0 cm TR-07-711-32



Schmieden
24,0 cm TR-07-713-21



flexible
20,0 cm TR-07-715-20



Cooper
19,0 cm TR-07-717-19

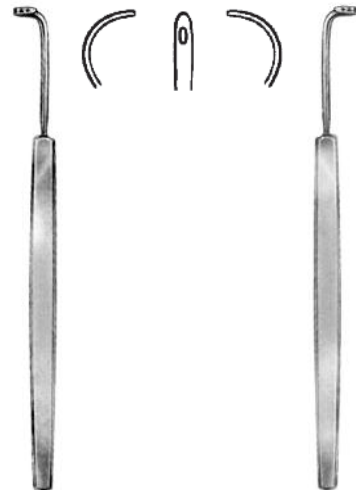

Kronecker
13,0 cm TR-07-721-13

Kronecker
13,0 cm TR-07-723-13

curved to left for the right hand

curved to right for the left hand



20,0 cm TR-07-725-20

sharp



TR-07-726-20

blunt



TR-07-728-20

blunt



TR-07-730-20

blunt



TR-07-733-20

blunt



TR-07-733-21

blunt



TR-07-733-24



Deschamps



Deschamps



24,0 cm 07-731-24

21,0 cm TR-07-731-21

Ligature Needles

curved to left for the right hand

curved to right for the left hand



Deschamps



28,0 cm **TR-07-731-28**

20,0 cm **TR-07-735-20**

21,0 cm **07-735-21**

27,0 cm **TR-07-735-27**

blunt



blunt



sharp



sharp



sharp



TR-07-733-27



TR-07-733-28



TR-07-737-20



07-737-21



TR-07-737-27

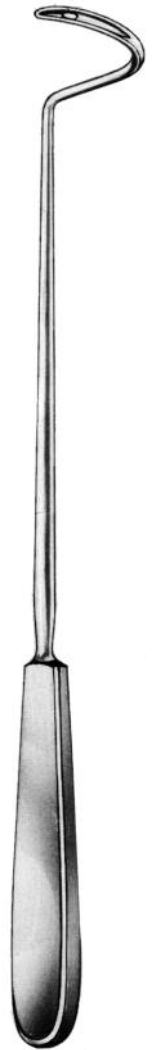

Deschamps



Brunner, 30,0 cm



TR-07-741-30



TR-07-743-30



Brunner, 30,0 cm



TR-07-745-30



TR-07-747-30

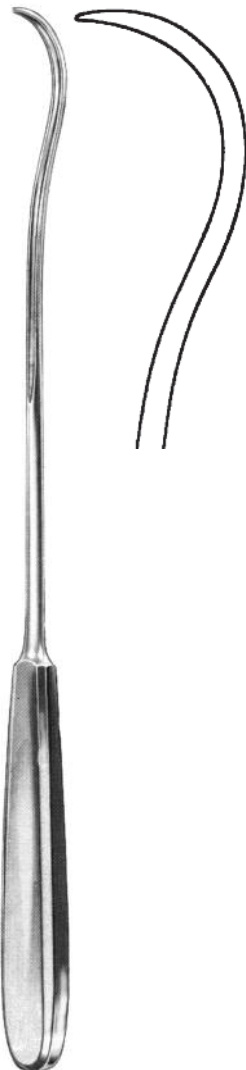

28,0 cm **TR-07-749-28**

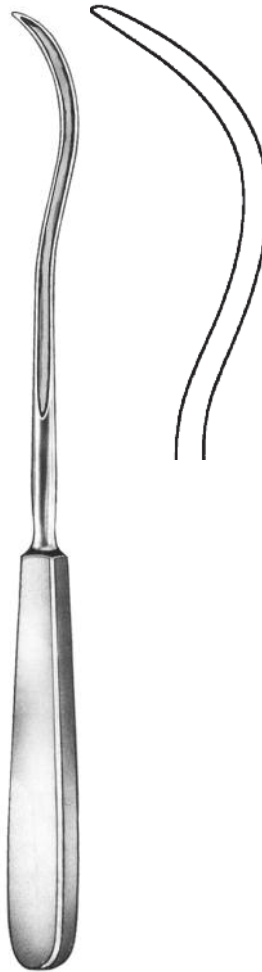

Kirschner
25,5 cm **TR-07-751-25**

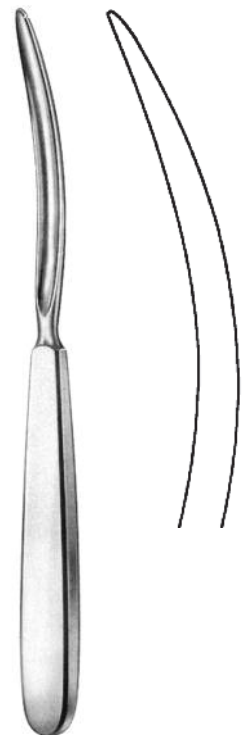

19,5 cm **TR-07-753-25**

Guiding Probes



Brunner

18,0 cm **TR-07-755-18**
27,0 cm **TR-07-755-27**



Kirschner

of plastic material, can be sterilized
27,0 cm **TR-07-757-27**



of plastic material, can be sterilized
19,0 cm **TR-07-758-19**



of plastic material, can be sterilized
19,0 cm **TR-07-759-19**



Schmieden, 19,0 cm



TR-07-761-19



TR-07-763-19



König, 19,0 cm



3 mm
TR-07-765-19



5 mm
TR-07-767-19



7 mm
TR-07-769-19

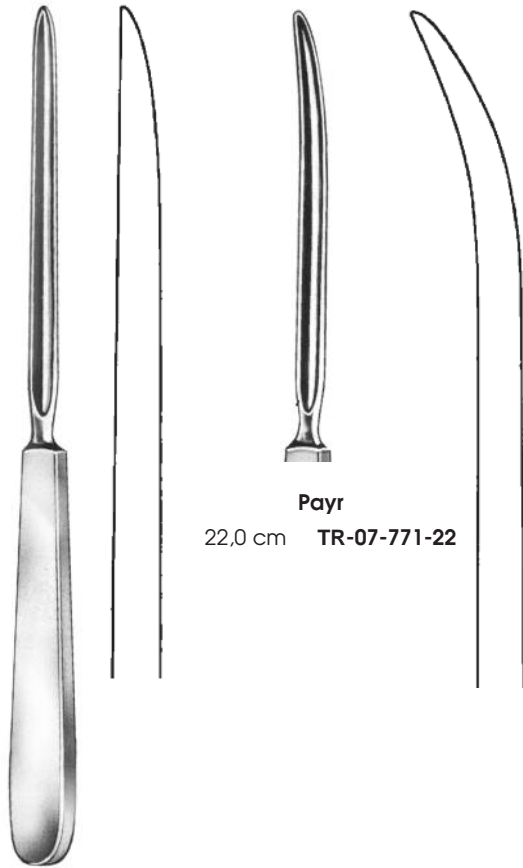

Payr
22,0 cm **TR-07-771-22**

Payr
22,0 cm **07-770-22**



of plastic material, can be sterilized
18,5 cm **TR-07-773-18**
24,0 cm **TR-07-772-24**

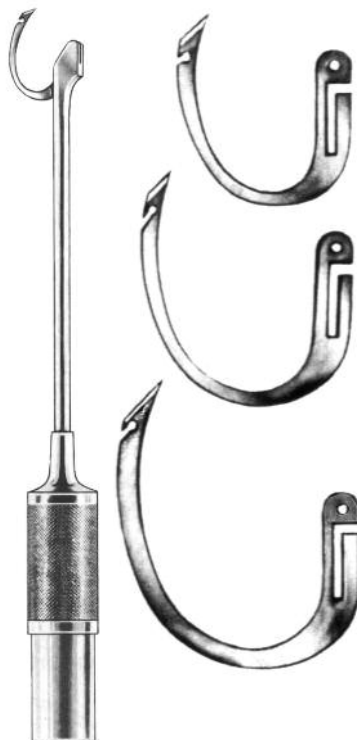

Fig. 1
spare needle
TR-07-790-51

Fig. 2
spare needle
TR-07-790-52

Fig. 3
spare needle
TR-07-790-53

Young-Millin
20,0 cm **TR-07-790-20**



Mod. Wien
Fadenfänger
Ligature Catcher
23,0 cm **TR-07-792-23**



Fadengabel
Ligatur Adjuster
23,0 cm **TR-07-794-23**

Suture Instruments, Wound Clips, SutureSet



Michel
12,5 cm **TR-07-907-12**



Michel
13,0 cm **TR-07-909-13**



Michel
12,0 cm **TR-07-910-12**



Wachenfeldt
12,0 cm **TR-07-912-12**



Wachenfeldt
12,0 cm **TR-07-914-12**



Hegenbarth
12,0 cm **TR-07-916-12**

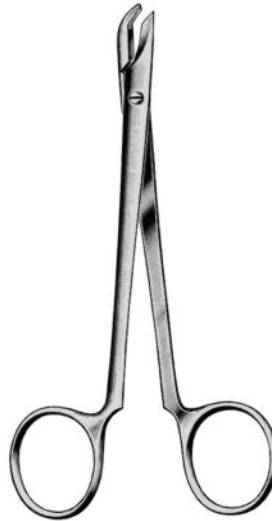

Collin
13,5 cm **TR-07-932-13**



Richter-Heath
13,5 cm **TR-07-933-13**



Michel

Packages of 1000 pieces

- 7,5 x 1,75 mm **TR-07-940-07**
- 11,0 x 2,00 mm **TR-07-940-11**
- 12,0 x 3,00 mm **TR-07-940-12**
- 14,0 x 3,00 mm **TR-07-940-14**
- 16,0 x 3,00 mm **TR-07-940-16**
- 18,0 x 3,00 mm **TR-07-940-18**
- 20,0 x 3,00 mm **TR-07-940-20**
- 22,0 x 3,00 mm **TR-07-940-22**

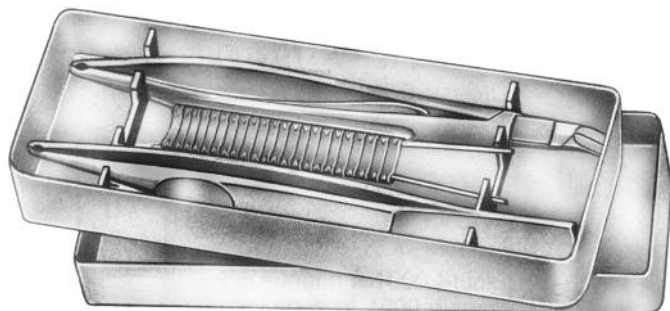

Michel, 130x45x18 mm

TR-07-952-00

Suture set consisting of:

1 clip applying forceps **TR-07-907-12**

1 wound grasping forceps **TR-07-910-12**

50 wound clips Michel



08

TC Needle Holders

TC Needle Holders

B&S-Nadelhalter sind durch die verschiedenen Einlageplättchen auf die jeweiligen Modelle und deren Verwendung abgestimmt.

Due to the different types of inserts, B&S needle holders differ according to the model and purpose for which they are intended.

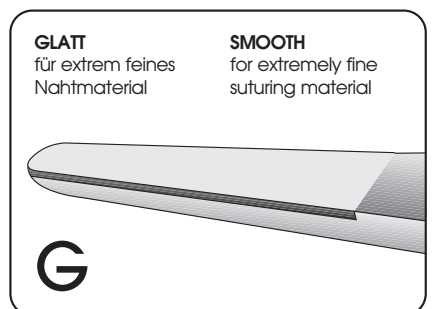
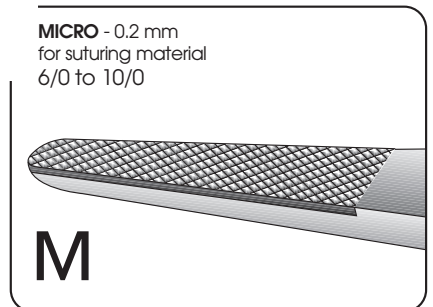
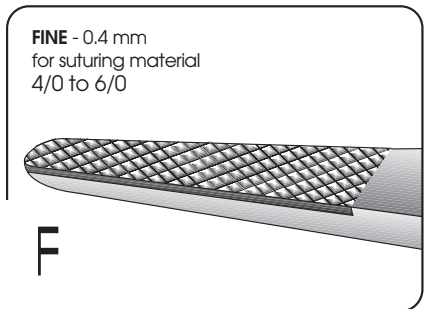
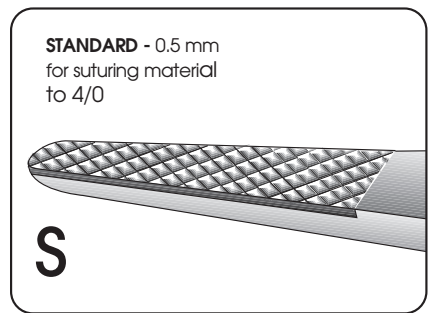
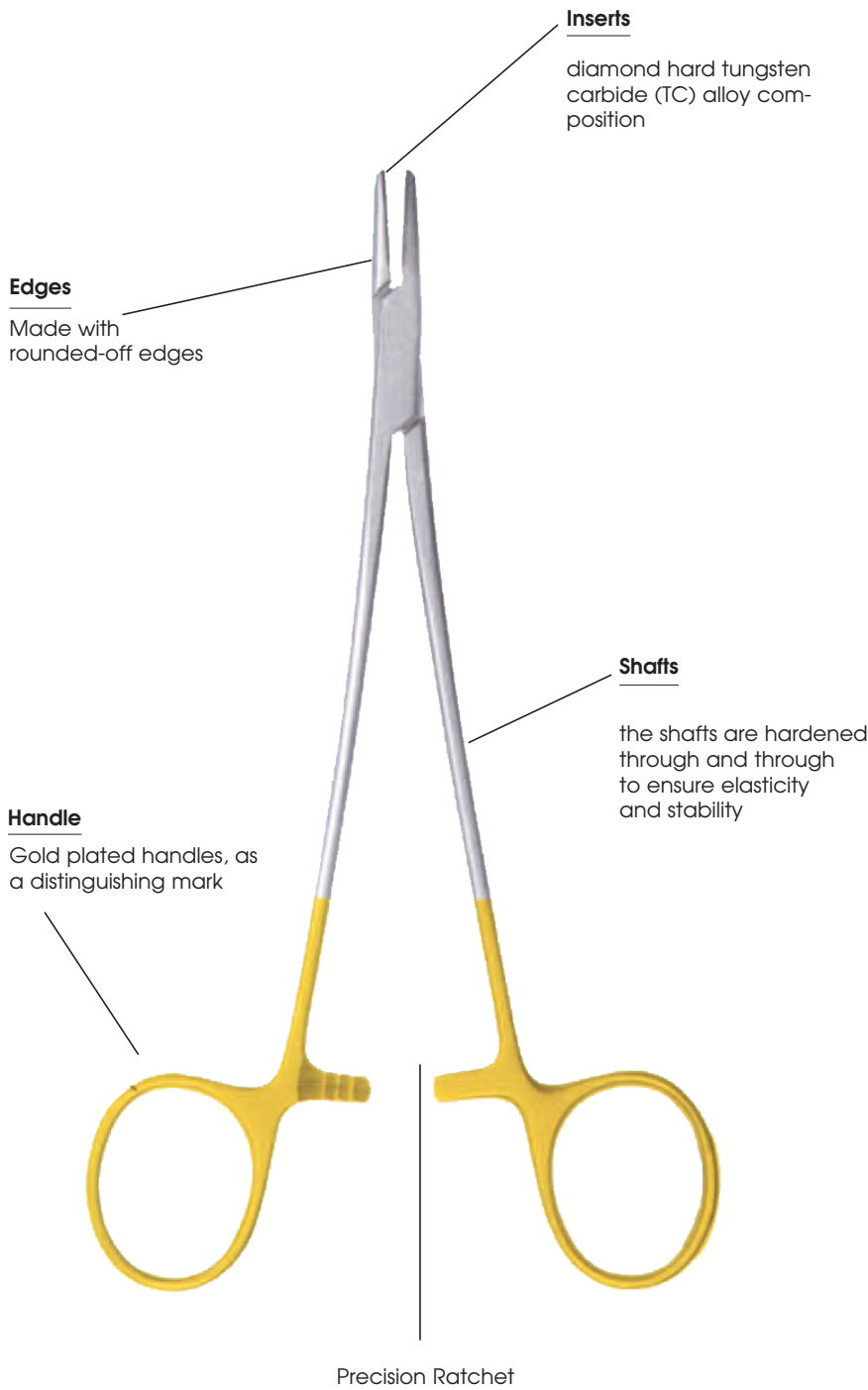



Hegar



20 cm
TR-08-000-20



24 cm
TR-08-000-24

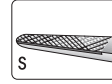

Mayo-Hegar



14 cm
TR-08-002-14



16 cm
TR-08-002-16



18 cm
TR-08-002-18



20 cm
TR-08-002-20



24 cm
TR-08-002-24



26 cm
TR-08-002-26



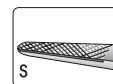

30 cm
TR-08-002-30



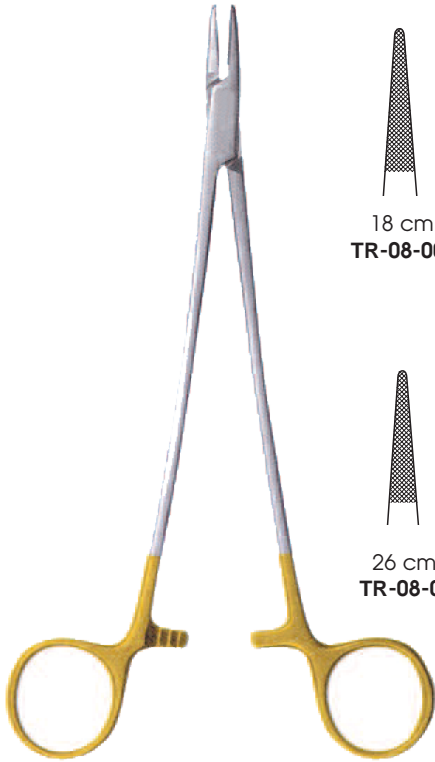

TC Needle Holders



- 
 18 cm
TR-08-004-18
- 
 20 cm
TR-08-004-20
- 
 23 cm
TR-08-004-23



- 
 26 cm
TR-08-004-26
- 
 31 cm
TR-08-004-31
- 
 37 cm
TR-08-004-37

De Bakey





- 
 18 cm
TR-08-010-18

- 
 20 cm
TR-08-010-20

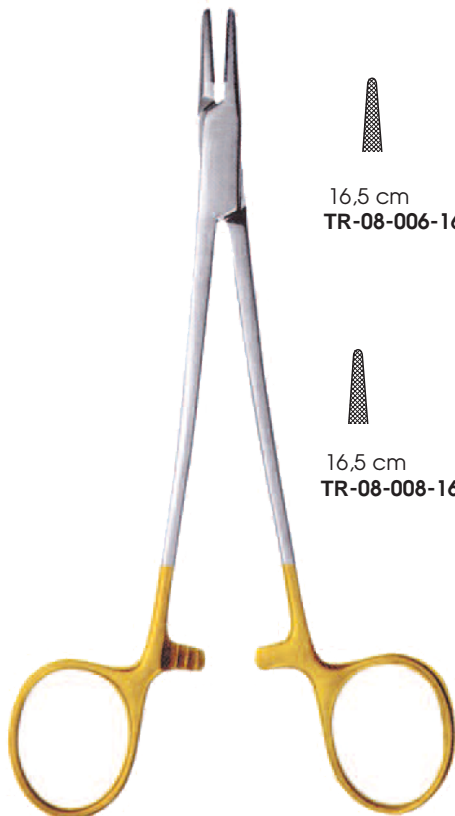

- 
 23 cm
TR-08-010-23

De Bakey
very delicate

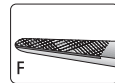

- 
 16,5 cm
TR-08-006-16
- 
 21 cm
TR-08-006-21



- 
 16,5 cm
TR-08-008-16
- 
 21 cm
TR-08-008-21

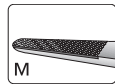

De Bakey
fine





Crile-Wood



Baby-Crile-Wood
15 cm TR-08-014-15

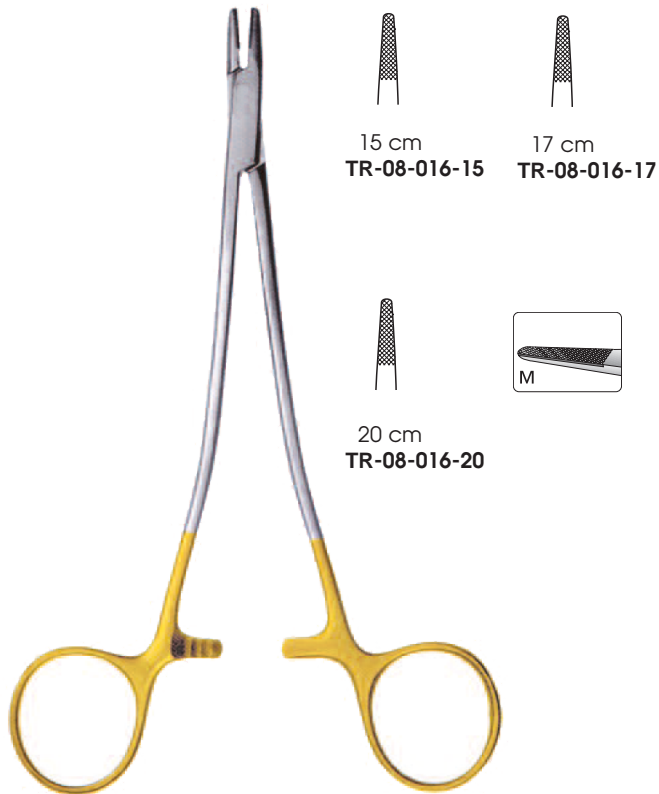

Senning

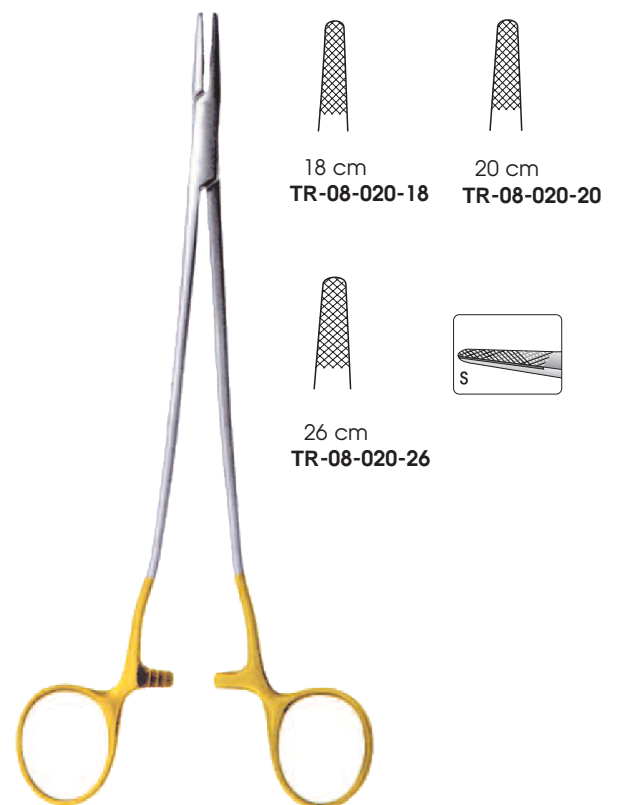

Sarot

TC Needle Holders

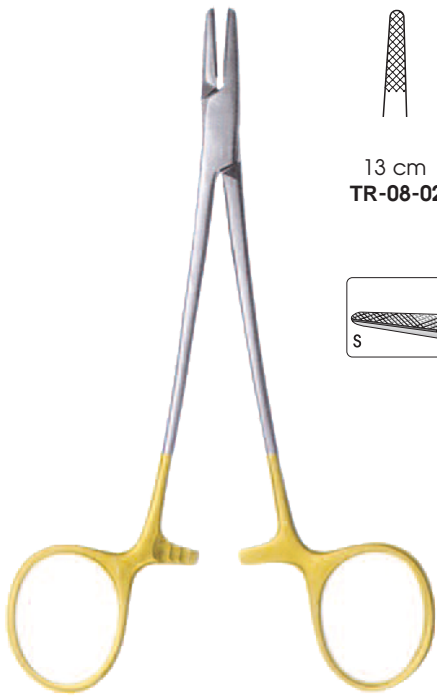

13 cm
TR-08-022-13



14 cm
TR-08-022-14

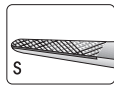

Hegar-Baumgartner

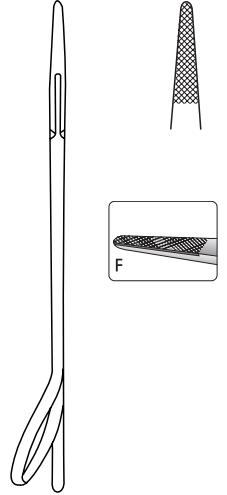

Masing
13 cm TR-08-024-13



13 cm
TR-08-026-13



13 cm
TR-08-028-13

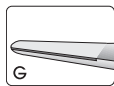

Halsey



12.5 cm
TR-08-030-12



13 cm
TR-08-030-13

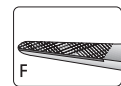

Webster



Kilner
13 cm TR-08-031-13



Derf
Derf-Converse



with automatic release ratchet

TC Needle Holders

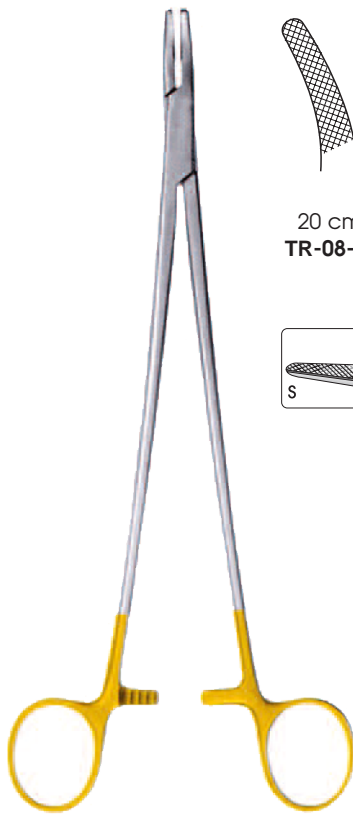

Heaney

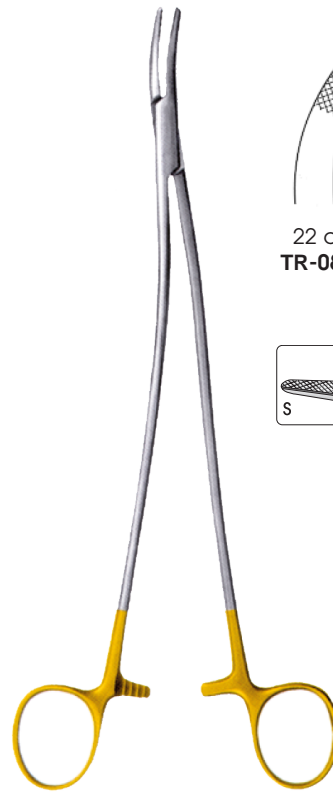
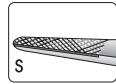
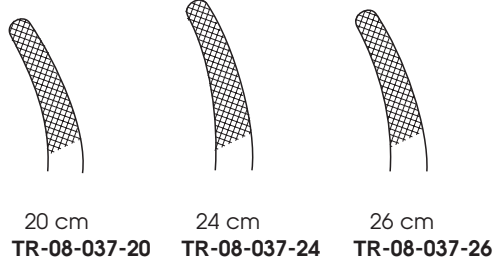

Stralfe

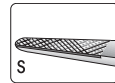
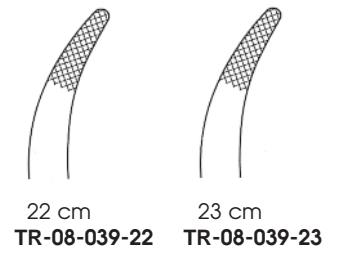

Bozemann

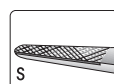
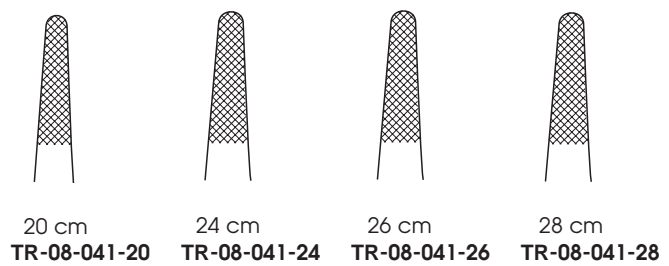

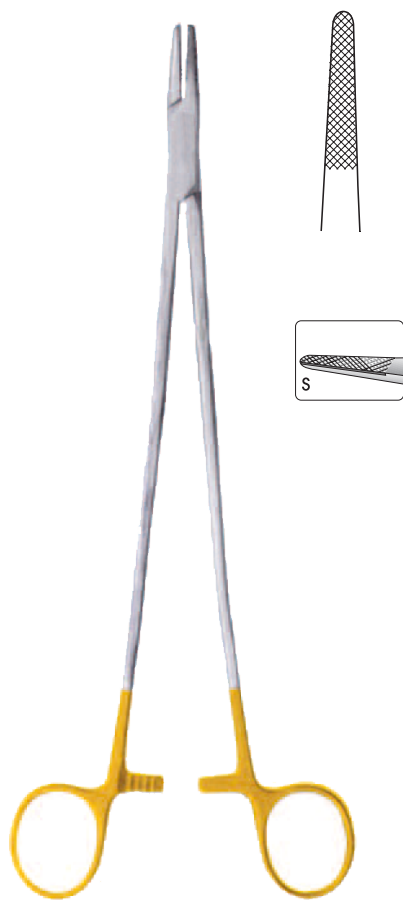

Masson
27 cm TR-08-042-27

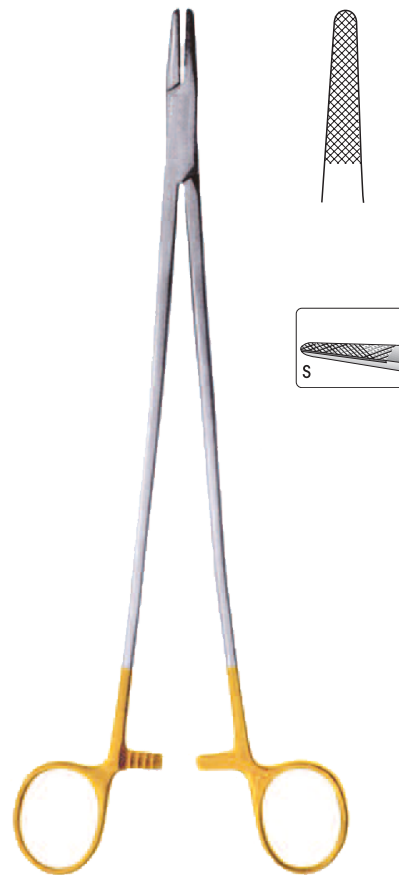

Wangensteen
27 cm TR-08-044-27

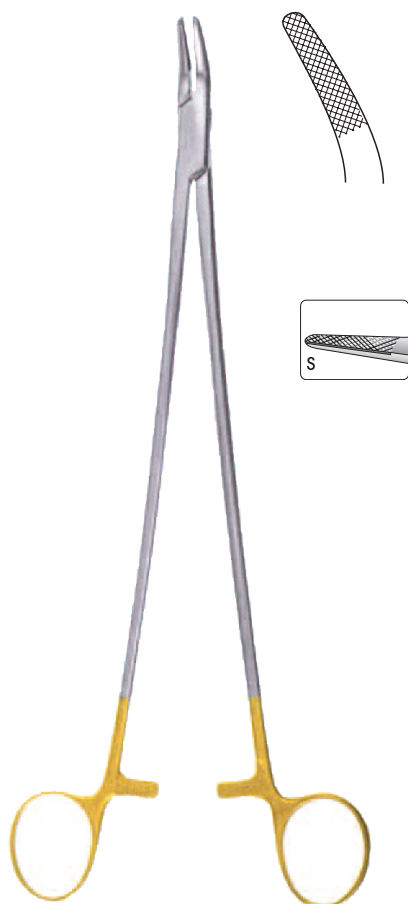

Finocchio
27 cm TR-08-045-27

TC Needle Holders



Olsen-Hegar



12,5 cm
TR-08-046-12

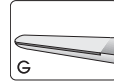

14 cm
TR-08-048-14



16,5 cm
TR-08-048-16



18 cm
TR-08-048-18

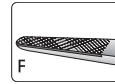

Gillies



11 cm
TR-08-049-11



16 cm
TR-08-049-16

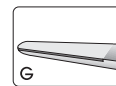

15 cm
TR-08-051-15



16 cm
TR-08-051-16

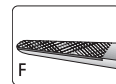



Mathieu

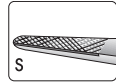
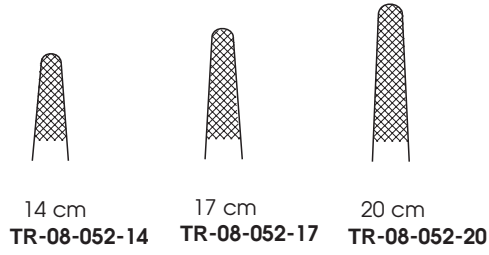

Mathieu
heavy model

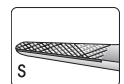
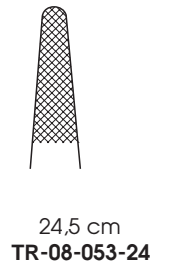
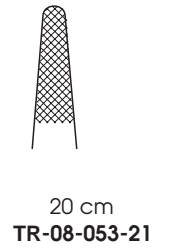

Mathieu
slim

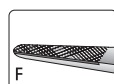
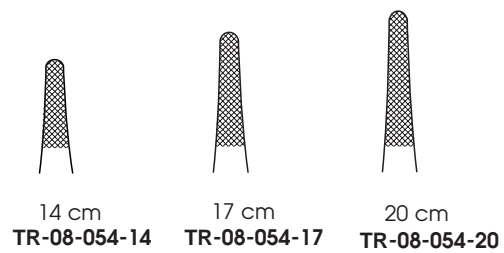

TC Needle Holders

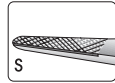

Lichtenberg
20 cm **TR-08-056-20**

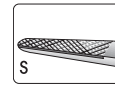
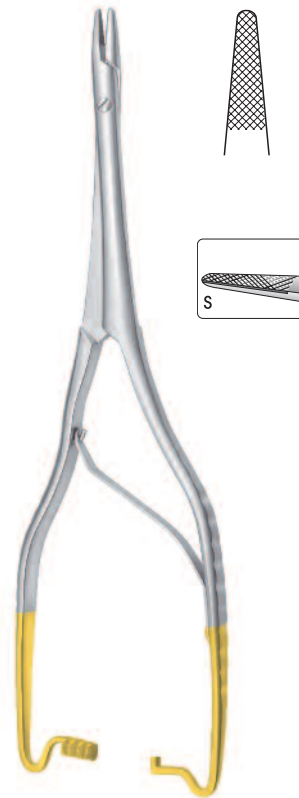

Hösel
26 cm **TR-08-058-26**



20 cm
TR-08-057-20



26 cm
TR-08-057-26

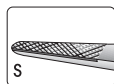

Needle Holder with long neck



Zweifel

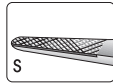
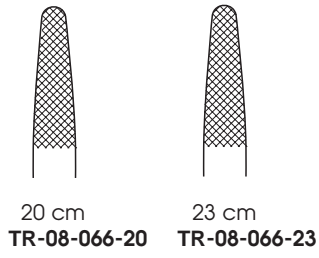

Toennis
18 cm TR-08-070-18



Langenbeck

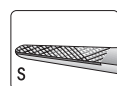
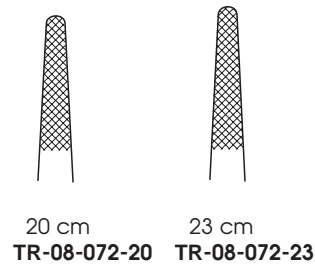
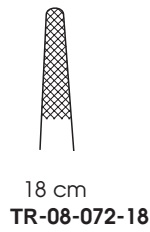



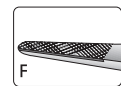
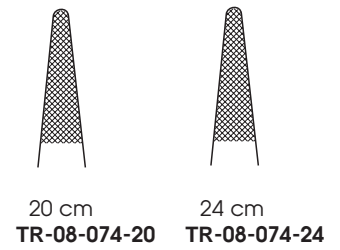

Langenbeck

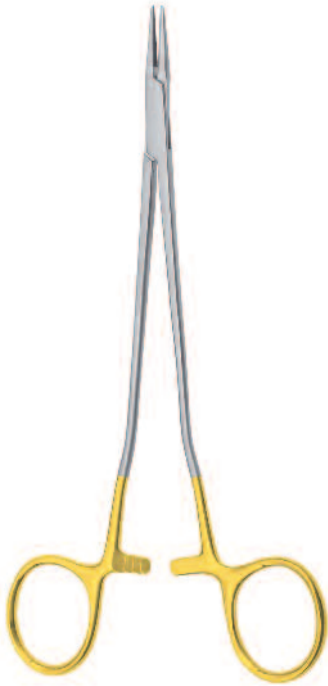

TC Needle Holders





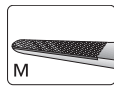

Hegar-Vascular

- 
 14 cm
TR-08-100-14
- 
 18 cm
TR-08-100-18
- 
 20 cm
TR-08-100-20
- 
 23 cm
TR-08-100-23





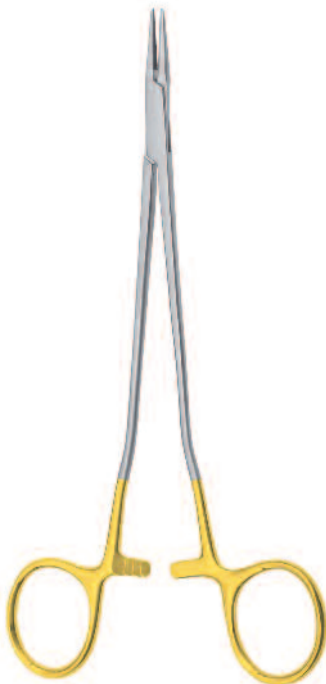
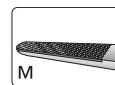

Hegar-Vascular
fine

- 
 14 cm
TR-08-102-14
- 
 16 cm
TR-08-102-16

- 
 18 cm
TR-08-102-18
- 
 20 cm
TR-08-102-20





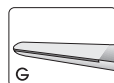

Hegar-Vascular
fine

- 
 14 cm
TR-08-104-14
- 
 16 cm
TR-08-104-16
- 
 18 cm
TR-08-104-18
- 
 20 cm
TR-08-104-20







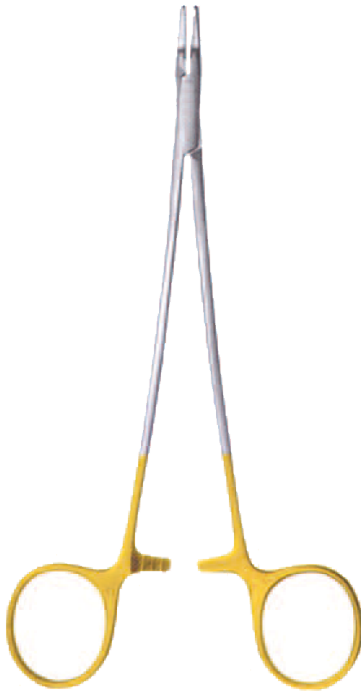
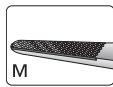

Micro-Vascular

- 
14 cm
TR-08-106-14
- 
18 cm
TR-08-106-18
- 
20 cm
TR-08-106-20
- 
23 cm
TR-08-106-23





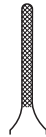

Ryder-Vascular

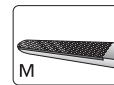
- 
13 cm
TR-08-110-13
- 
15 cm
TR-08-110-15
- 
18 cm
TR-08-110-18

- 
20 cm
TR-08-110-20
- 
23 cm
TR-08-110-23
- 
26 cm
TR-08-110-26

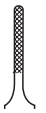

Ryder-Mikro

- 
13 cm
TR-08-112-13
- 
15 cm
TR-08-112-15
- 
18 cm
TR-08-112-18
- 
20 cm
TR-08-112-20
- 
23 cm
TR-08-112-23
- 
26 cm
TR-08-112-26

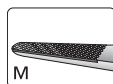

TC Needle Holders



Dietrich-Vascular

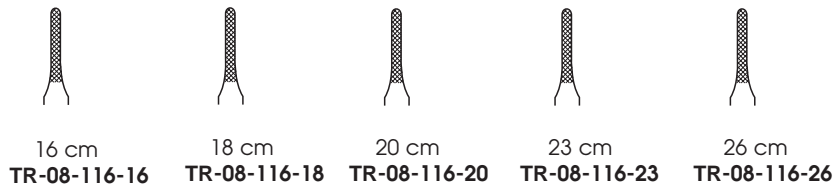

Mathieu-Ryder

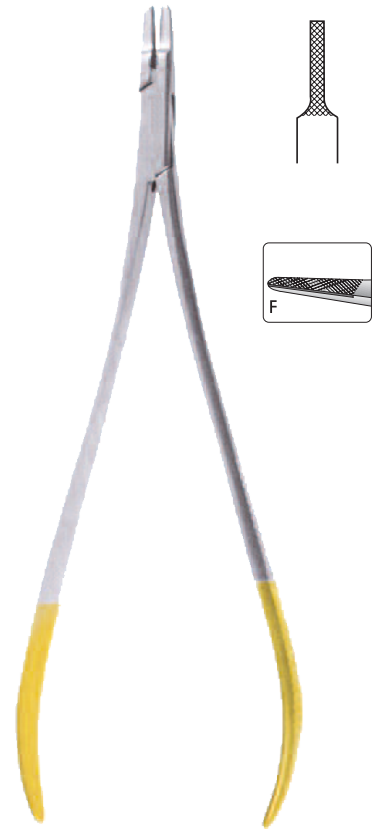
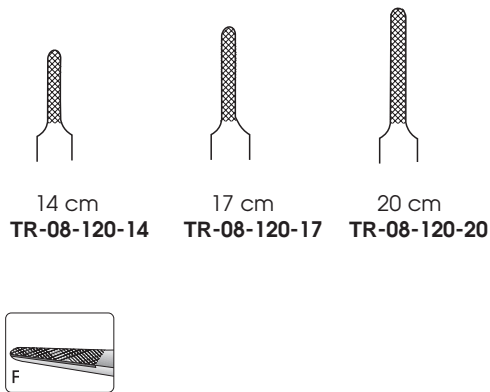

Langenbeck-Ryder
20 cm TR-08-130-20

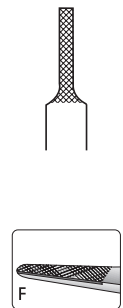



Castroviejo



14 cm
WS-08-610-14



14 cm
WS-08-611-14

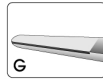

14 cm
WS-08-612-14



18 cm
WS-08-612-18



22 cm
WS-08-612-22



14 cm
WS-08-613-14



18 cm
WS-08-613-18



22 cm
WS-08-613-22

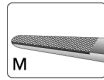

Barraquer



14 cm **WS-08-672-14**
18 cm **WS-08-672-18**

with catch



14 cm **WS-08-673-14**
18 cm **WS-08-673-18**

without catch

14 cm **WS-08-674-14**
18 cm **WS-08-674-18**

14 cm **WS-08-675-14**
18 cm **WS-08-675-18**

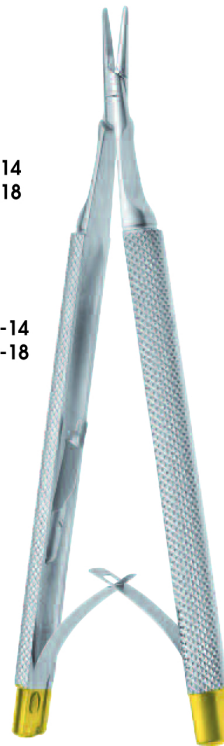
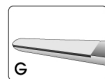

Castroviejo



14 cm
WS-08-680-14



14 cm
WS-08-681-14

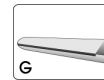



09

NEURO

Brain Spatula



Cushing

malleable

- | | |
|--------------|---------------------|
| 07+09/180 mm | TR-11-112-07 |
| 11+13/180 mm | TR-11-112-11 |
| 15+18/180 mm | TR-11-112-15 |
| 18+22/180 mm | TR-11-112-18 |



malleable

- | | |
|-----------|---------------------|
| 09/200 mm | TR-11-113-09 |
| 12/200 mm | TR-11-113-12 |
| 12/250 mm | TR-11-113-13 |



Heifetz

concave

- | | |
|----------|---------------------|
| 07/09 mm | TR-11-124-07 |
| 11/13 mm | TR-11-124-11 |
| 15/18 mm | TR-11-124-15 |
| 18/22 mm | TR-11-124-18 |

flexible

- | | |
|-----------|---------------------|
| 08/155 mm | TR-11-115-08 |
| 11/155 mm | TR-11-115-11 |
| 14/155 mm | TR-11-115-14 |
| 17/155 mm | TR-11-115-17 |
| 08/200 mm | TR-11-120-08 |
| 11/200 mm | TR-11-120-11 |
| 14/200 mm | TR-11-120-14 |
| 17/200 mm | TR-11-120-17 |
| 20/200 mm | TR-11-120-20 |



Olivecrona

convex

- | | |
|----------|---------------------|
| 07/09 mm | TR-11-125-07 |
| 11/13 mm | TR-11-125-11 |
| 15/18 mm | TR-11-125-15 |
| 18/22 mm | TR-11-125-18 |

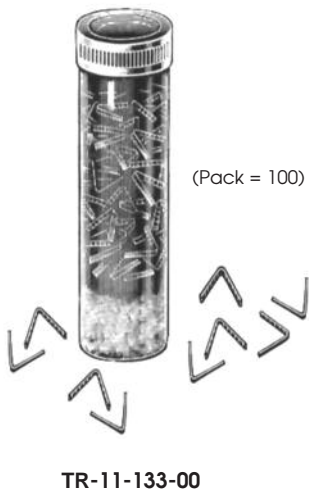
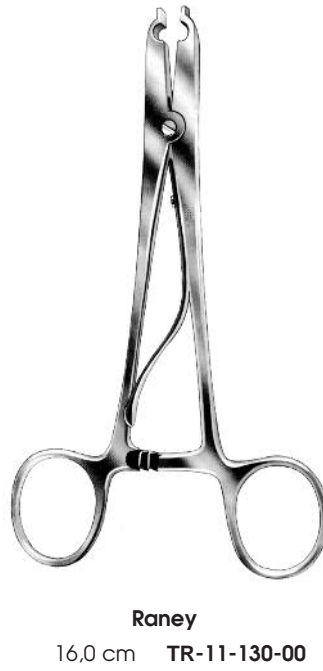

Applying Forceps

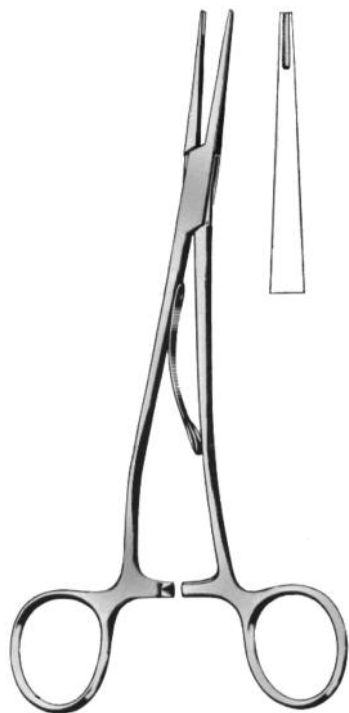

McKenzie

15,0 cm **TR-11-136-15**
19,0 cm **TR-11-136-19**

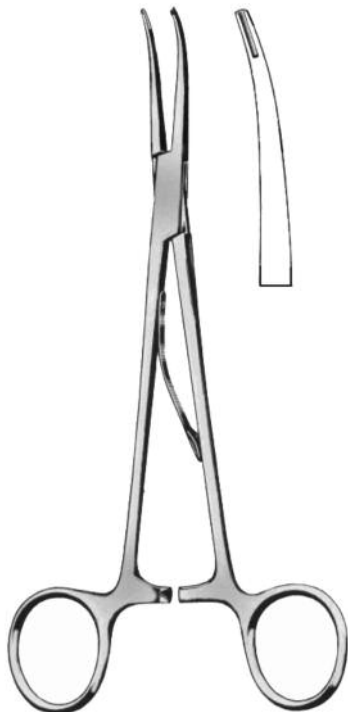

McKenzie

15,0 cm **TR-11-137-15**
19,0 cm **TR-11-137-19**

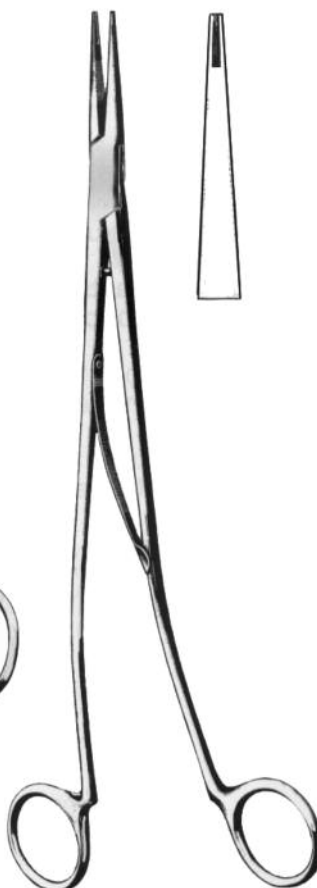

Sweet

23,0 cm **TR-11-138-23**
26,0 cm **TR-11-138-26**

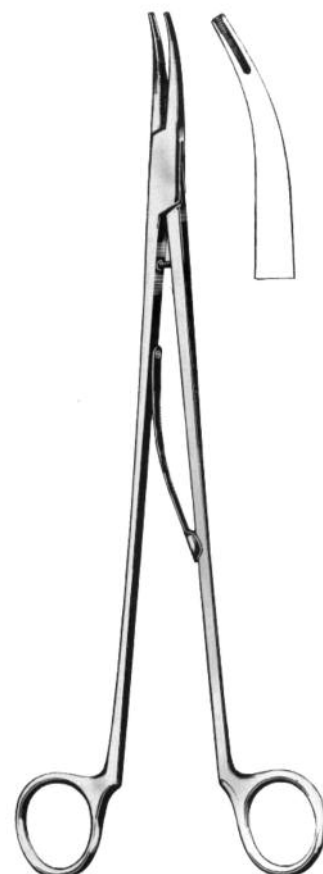

Smithwick

23,0 cm **TR-11-139-23**
26,0 cm **TR-11-139-26**

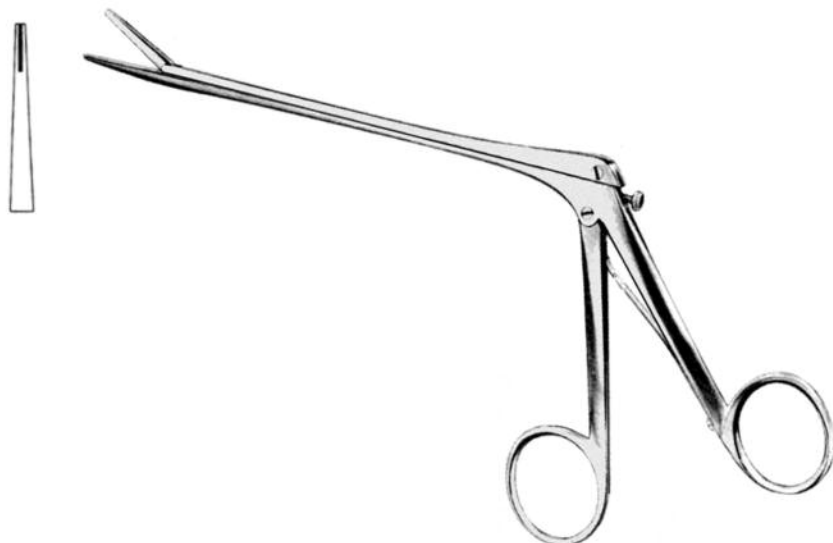

Olivecrona-Toennis

14,0 cm **TR-11-140-14**



Crutchfield
TR-11-150-02

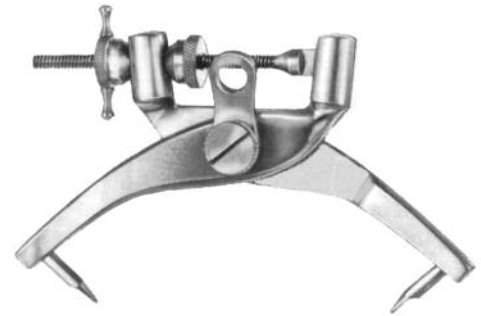

Crutchfield
TR-11-150-01

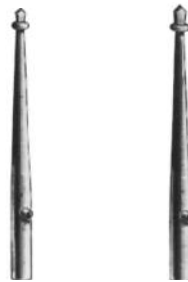

Drill points

TR-11-152-35
Ø 3,5 mm

TR-11-152-50
Ø 5,0 mm



Crutchfield
TR-11-150-03

Spare Pin only (whithout illustration)
TR-11-151-00

Skull Punch



Dahlgren
20,0 cm TR-11-154-20



De Vibiss
20,0 cm TR-11-156-21



De Martel
33,0 cm **TR-11-158-33**



Olivecrona

18,0 cm **TR-11-160-18**
24,0 cm **TR-11-160-24**



19,5 cm **TR-11-161-19**
24,0 cm **TR-11-161-24**



Sachs, 21,0 cm



3,0 mm
TR-11-163-03



6,0 mm
TR-11-163-06

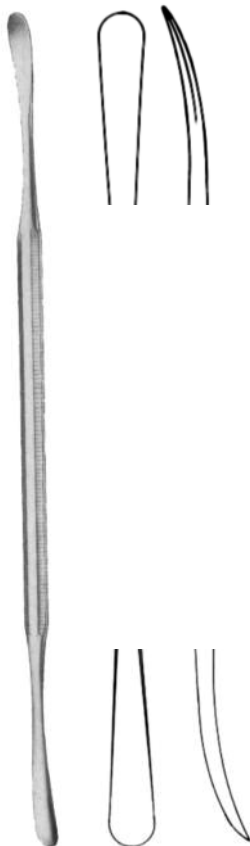

Dissektor
22,0 cm **TR-11-165-22**

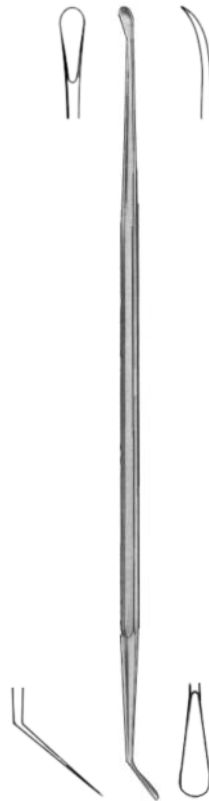

Milligan
21,0 cm **TR-11-167-21**



Sachs
21,0 cm **TR-11-169-21**

Dura Dissectors, Nerve Root Retractors



Frazier

15,0 cm **TR-11-170-01**



Hoen

15,0 cm **TR-11-170-02**



Hoen

15,0 cm **TR-11-170-03**



Love

19,0 cm **TR-11-172-02**



Love

TR-11-172-01

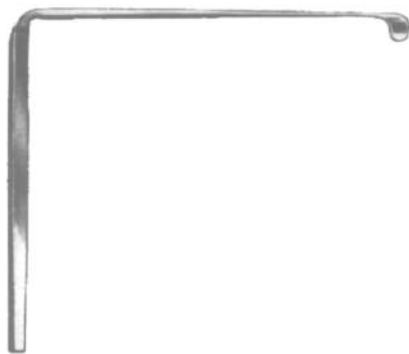

Love

TR-11-172-03

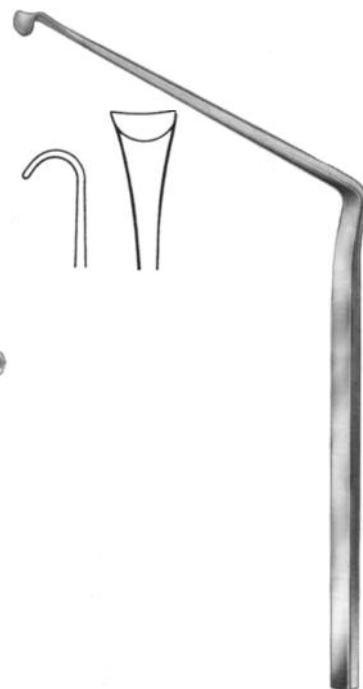

Nerve Root Retractor

19,0 cm **TR-11-173-19**

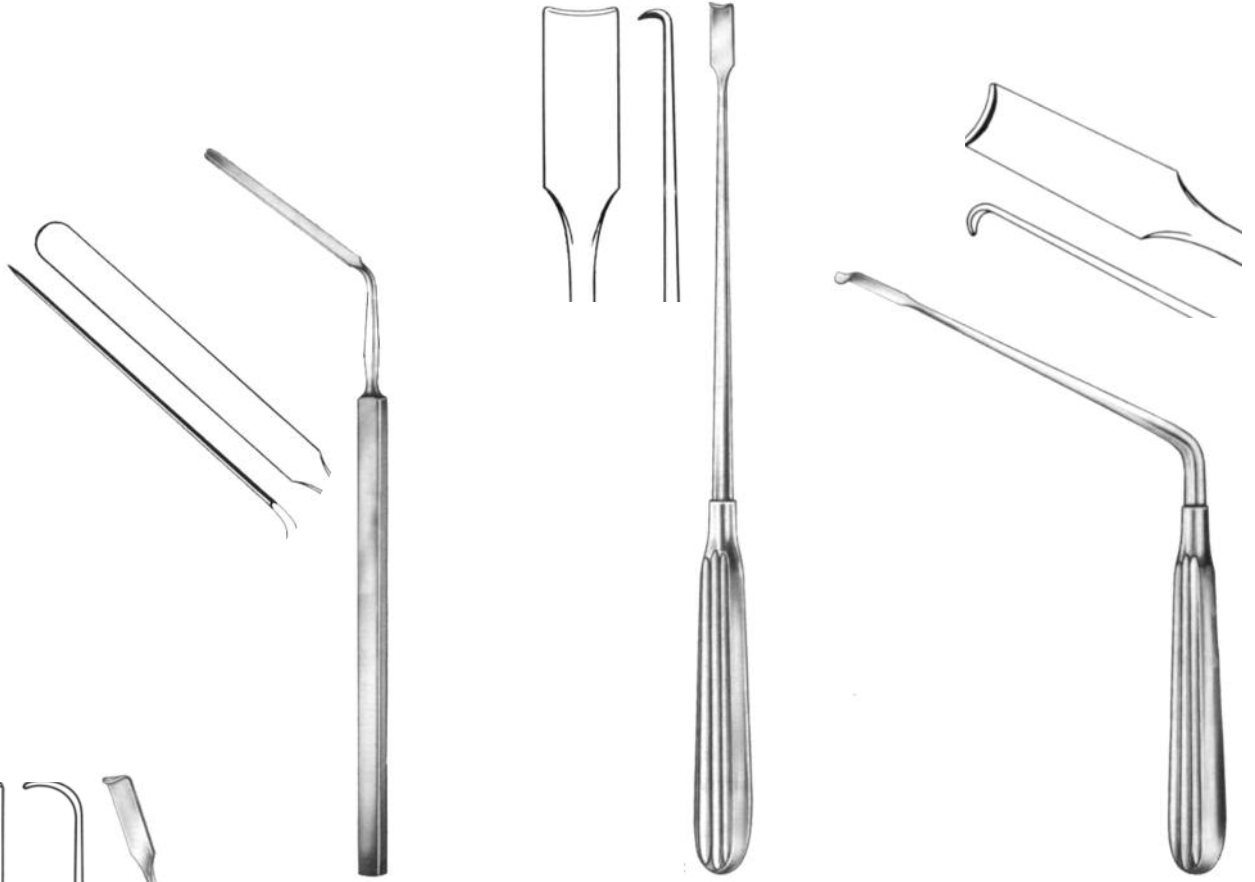

Horsley
20,0 cm TR-11-175-20

Scoville
23,0 cm TR-11-176-23

Scoville
19,0 cm TR-11-177-19

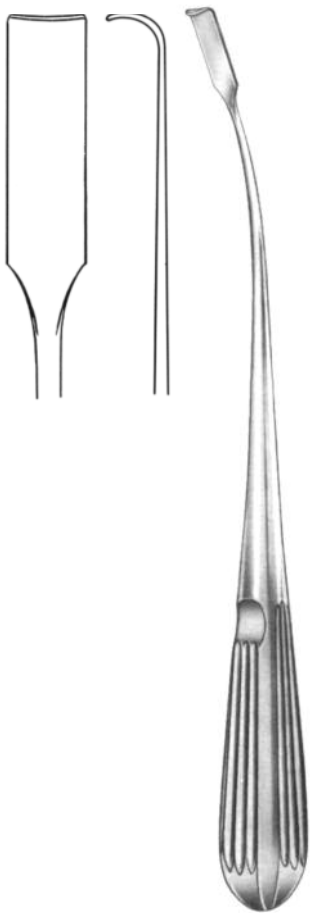

Holsher
24,0 cm TR-11-179-24



Toennis



13,0 cm
TR-11-180-13



19,0 cm
TR-11-180-19



Halle
20,0 cm TR-11-182-20

Nerve Hooks



Smithwick

17,0 cm TR-11-187-17
21,0 cm TR-11-187-21



Dandy

20,0 cm TR-11-188-20



Adson

20,0 cm TR-11-190-20



Graham

16,5 cm TR-11-191-16



Sachs

18,5 cm TR-11-192-18



Toennis

15,0 cm TR-11-193-15



Cushing

14,0 cm TR-11-194-14



Frazier

13,0 cm TR-11-195-13
18,0 cm TR-11-195-18



Adson

20,0 cm TR-11-196-20

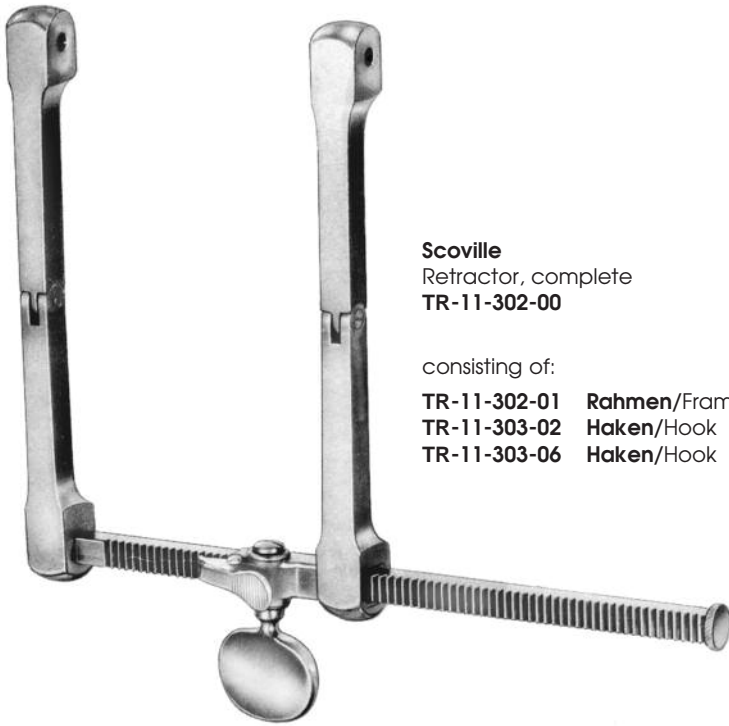

Scoville
Retractor, complete
TR-11-302-00

consisting of:
TR-11-302-01 Rahmen/Frame
TR-11-303-02 Haken/Hook
TR-11-303-06 Haken/Hook

Scoville
Frame only
TR-11-302-01

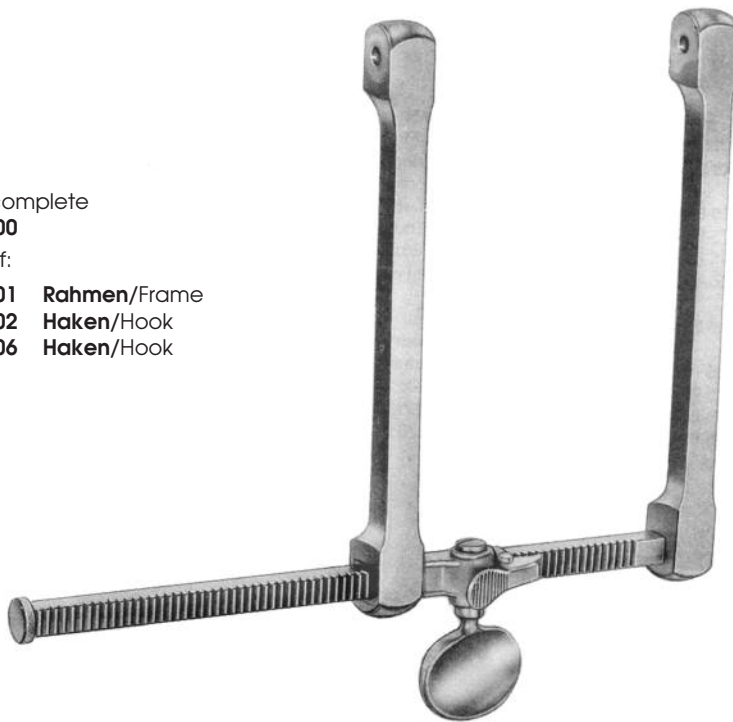

Scoville
Retractor, complete
TR-11-303-00
consisting of:
TR-11-303-01 Rahmen/Frame
TR-11-303-02 Haken/Hook
TR-11-303-06 Haken/Hook

Scoville
Frame only
TR-11-303-01



TR-11-303-02 50 mm



TR-11-303-03 70 mm



TR-11-303-04 50 mm



TR-11-303-05 70 mm



TR-11-303-06 64x25 mm
 TR-11-303-07 64x50 mm
 TR-11-303-08 88x25 mm



TR-11-303-11 48x50 mm
 TR-11-303-12 64x50 mm
 TR-11-303-13 64x64 mm
 TR-11-303-14 80x57 mm



TR-11-303-15 41x38 mm
 TR-11-303-16 67x44 mm

Retractors for Spine



Caspar

TR-11-354-00
(TR-11-358-01 - TR- 11-358-15)
Retractor, with 10 blades
(TR-11-358-01 - TR- 11-358-15)

TR-11-354-01 Retractor,only



Caspar

TR-11-355-00
(TR-11-358-21 - TR- 11-358-25)
Counter Retractor, with 5 blades
(TR-11-358-21 - TR- 11-358-25)

TR-11-355-01 CounterRetractor,only



Caspar

TR-11-356-00
(TR-11-358-21 - TR- 11-358-25)
Counter Retractor, with 5 blades
(TR-11-358-21 - TR- 11-358-25)

TR-11-356-01 CounterRetractor,only

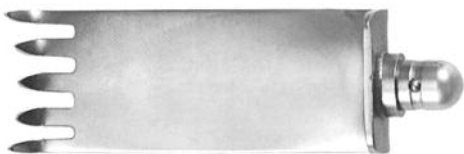

11-358-01 40x23 mm
11-358-02 45x23 mm
11-358-03 50x23 mm
11-358-04 55x23 mm
11-358-05 60x23 mm

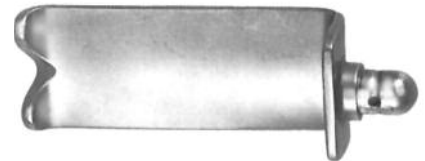

11-358-21 45x23 mm
11-358-22 50x23 mm
11-358-23 55x23 mm
11-358-24 60x23 mm
11-358-25 65x23 mm

Blades for Spine Retractors

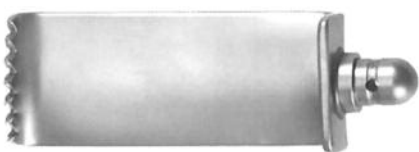

TR-11-358-11 40x23 mm
TR-11-358-12 45x23 mm
TR-11-358-13 50x23 mm
TR-11-358-14 55x23 mm
TR-11-358-15 60x23 mm



TR-11-358-31 50x25 mm
TR-11-358-32 60x25 mm



Cloward, 26,0 cm

TR-11-361-00
(TR-11-363-02 - TR- 11-363-06)
Wound Spreader, complete
(TR-11-363-02 - TR- 11-363-06)

TR-11-361-01 WoundSpreader,only



TR-11-363-02 40 mm
TR-11-363-03 45 mm
TR-11-363-04 50 mm
TR-11-363-05 55 mm
TR-11-363-06 60 mm



TR-11-363-12 40 mm
TR-11-363-13 45 mm
TR-11-363-14 50 mm
TR-11-363-15 55 mm
TR-11-363-16 60 mm



Cloward, 16,0 cm

TR-11-362-00
(TR-11-363-12 - TR- 11-363-16)
Wound Spreader, complete
(TR-11-363-12 - TR- 11-363-16)

TR-11-362-01 WoundSpreader,only

Wound Spreaders



Caspar
TR-11-365-00
(TR-11-365-02 - TR-11-365-08)
Counter Retractor, complete
(TR-11-365-02 - TR-11-365-08)
TR-11-365-01 CounterRetractor,only



TR-11-365-02 40 mm
TR-11-365-03 45 mm
TR-11-365-04 50 mm
TR-11-365-05 55 mm
TR-11-365-06 60 mm
TR-11-365-07 70 mm
TR-11-365-08 80 mm



Caspar
40 mm **TR-11-366-40**
45 mm **TR-11-366-45**
50 mm **TR-11-366-50**
55 mm **TR-11-366-55**
60 mm **TR-11-366-60**
65 mm **TR-11-366-65**
75 mm **TR-11-366-75**
85 mm **TR-11-366-85**



Caspar
TR-11-367-00
(TR-11-367-02 - TR-11-367-07)
Counter Retractor, complete
(TR-11-367-02 - TR-11-367-07)
TR-11-367-01 CounterRetractor,only



TR-11-367-02 35 mm
TR-11-367-03 40 mm
TR-11-367-04 45 mm
TR-11-367-05 50 mm
TR-11-367-06 55 mm
TR-11-367-07 60 mm
TR-11-367-08 65 mm
TR-11-367-09 75 mm
TR-11-367-10 85 mm

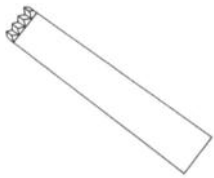

Cloward
15,5 cm TR-11-371-15



Inge

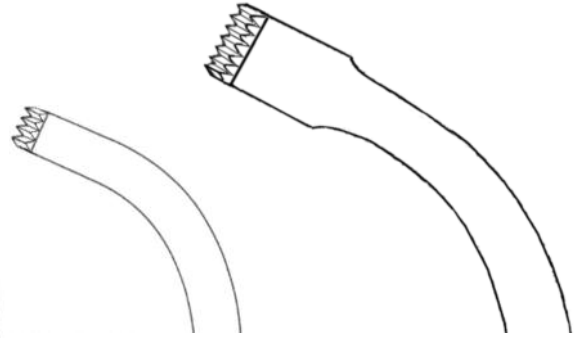

17,0 cm
TR-11-375-02

27,0 cm
TR-11-376-27



Cushing-Landolt
70x15 mm TR-11-400-01
90x15 mm TR-11-400-02
110x15 mm TR-11-400-03



10

E N T - Instruments

Tongue Depressor, Mouth Gag



Brünings
19,0 cm TR-17-006-19

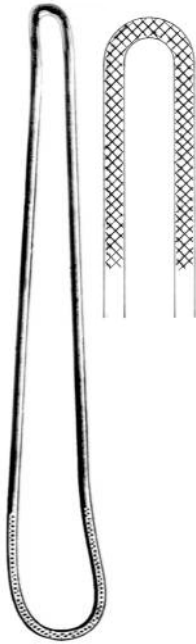

Frenzel
16,5 cm TR-17-007-16



Hartmann
15,0 cm TR-17-011-15

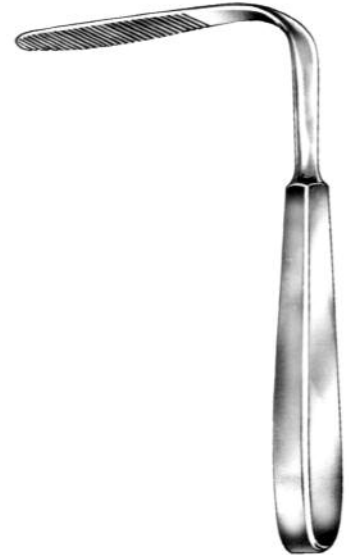

Tobald
16,0 cm TR-17-013-16



TR-17-017-01



TR-17-017-02



Weder, 15,0 cm



Heister
13,0 cm TR-17-022-13



Molt
10,0 cm TR-17-023-10



Doyen-Jansen
14,0 cm TR-17-026-14



Denhardt
12,0 cm TR-17-028-12



Roser-König
16,0 cm TR-17-029-16
19,0 cm TR-17-029-19

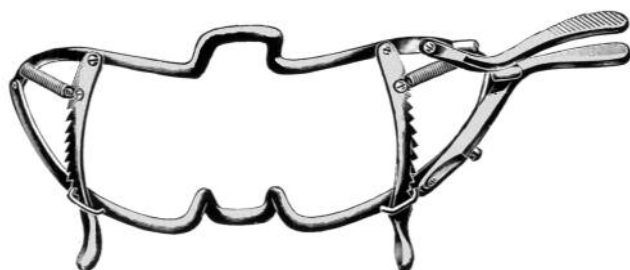

Whitehead
11,0 cm TR-17-031-11
13,0 cm TR-17-031-13
15,0 cm TR-17-031-15

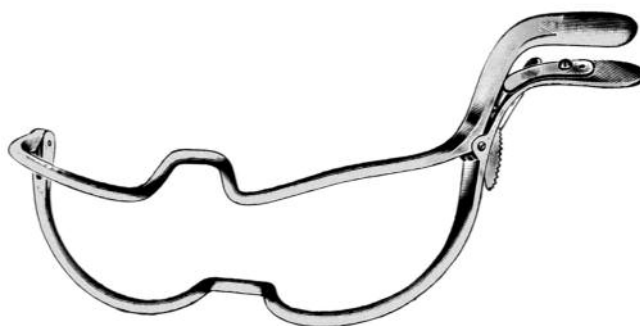

Whitehead-Jennings
9,0 cm TR-17-033-09
11,0 cm TR-17-033-11
13,0 cm TR-17-033-13
15,0 cm TR-17-033-15

Mouth Gag, Tongue Depressor



Dingmann, complete

TR-17-035-00

consisting of:

2 rotating cheek holders

2 movable tooth hooks and thread guide

each 1 Tongue blade Dingmann **TR-17-056-01,-02,-03**

Dingmann, Handle only

TR-17-035-01



Davis-Boyle

TR-17-041-00 adult
TR-17-042-00 infant
TR-17-043-00 children



Kilner-Doughty

TR-17-044-19



McIvor

TR-17-045-00



Russel-Davis

28x 65 mm	TR-17-050-01
33x 75 mm	TR-17-050-02
37x 80 mm	TR-17-050-03
41x 94 mm	TR-17-050-04
46x103 mm	TR-17-050-05



Gast

28x65 mm	TR-17-052-01
32x75 mm	TR-17-052-02
37x80 mm	TR-17-052-03

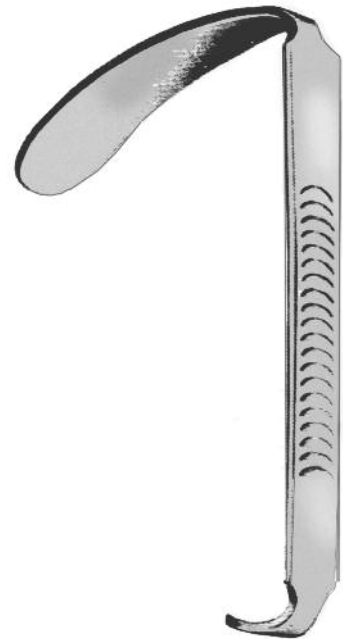

McIvor

23x 70 mm	TR-17-054-01
25x 86 mm	TR-17-054-02
26x100 mm	TR-17-054-03



Davis-Boyle

21x 30 mm	TR-17-055-01	
23x 65 mm	TR-17-055-02*	
24x 80 mm	TR-17-055-03*	*with anesthetic tube
25x 93 mm	TR-17-055-04*	
26x108 mm	TR-17-055-05*	

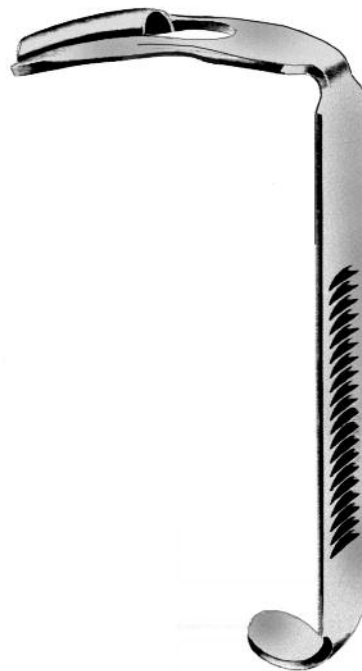

Dingmann

24x62 mm	TR-17-056-01
28x65 mm	TR-17-056-02
31x75 mm	TR-17-056-03

Chest support, LipRetractor, Tongue Depressor, Tongue Holding Forceps



Negus
Chest support
TR-17-060-00



Sternberg
12,0 cm TR-17-070-12
14,0 cm TR-17-070-14
16,0 cm TR-17-070-16

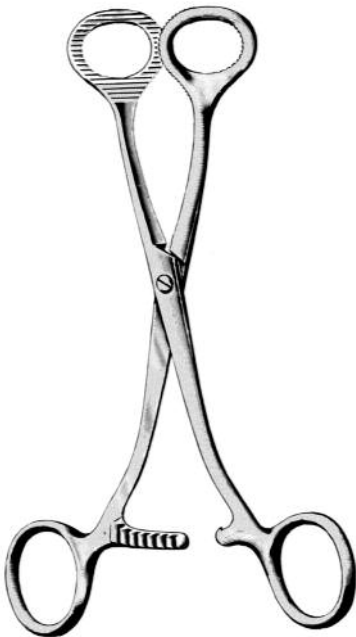

Collin
16,0 cm TR-17-072-16
18,0 cm TR-17-072-18

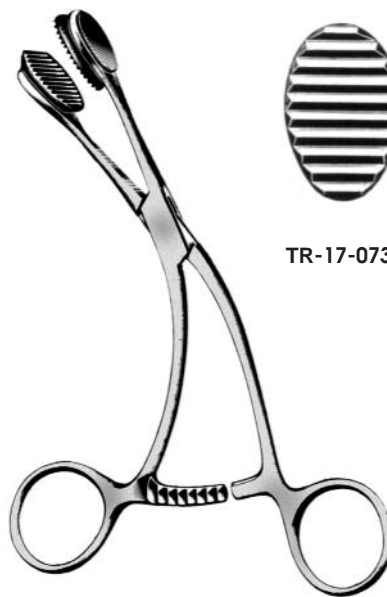

Young
16,0 cm TR-17-073-16



TR-17-073-99



Bishop
13,0 cm TR-17-074-13



White

18,0 cm **TR-17-085-18**
23,5 cm **TR-17-085-23**



Blohmke

20,5 cm **TR-17-093-20**



Ballenger

21,5 cm **TR-17-094-21**



Marschik

22,0 cm **TR-17-096-22**

Dissectors



Carpenter
25,0 cm **WS-17-100-01**



24,0 cm **WS-17-100-02**

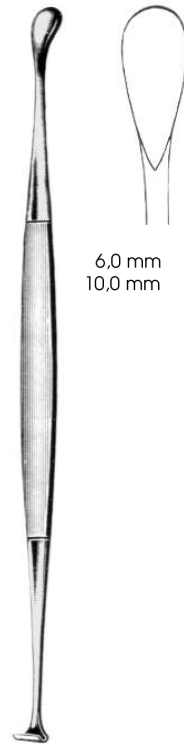

6,0 mm **WS-17-101-01**
10,0 mm **WS-17-101-02**

Hurd, 21,5 cm



10,0 mm **WS-17-102-01**
17,0 mm **WS-17-102-02**

Henke, 23,5 cm



Abraham
21,5 cm TR-17-106-21



Brünings
21,5 cm TR-17-107-21



Fisher
20,5 cm TR-17-109-20



Eves
25,0 cm TR-17-150-25 without catch
25,0 cm TR-17-152-25 with catch



Roeder
26,5 cm TR-17-153-26



Brünings
27,0 cm TR-17-154-27

Tonsil Snares, Tonsilotomes

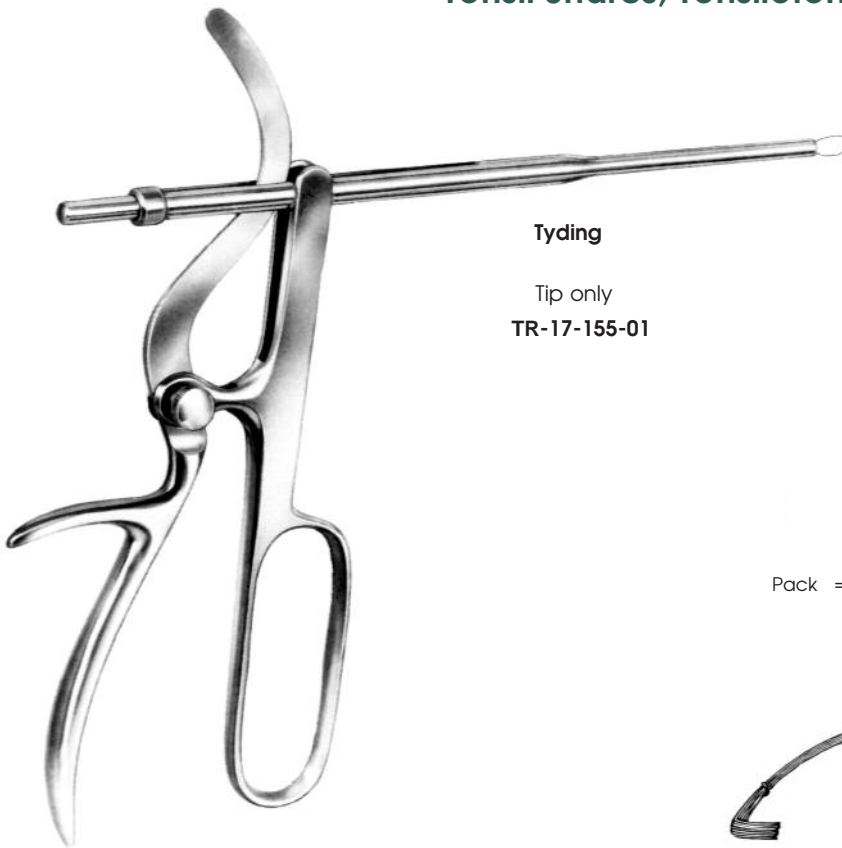

Tyding
Tip only
TR-17-155-01

Tyding
with tip
TR-17-155-00

Pack = 12 pieces



TR-17-156-03 Ø 0,3 mm
TR-17-156-05 Ø 0,5 mm

Pack = 100 pieces



TR-17-157-04 40,0 mm
TR-17-157-05 50,0 mm



Sluder-Ballenger

complete with 3 tips
TR-17-159-00

Handle only
TR-17-159-04

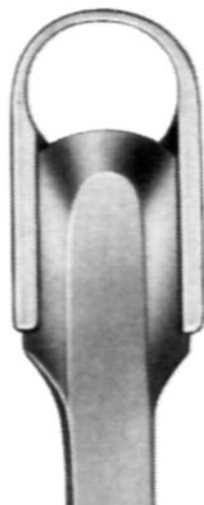

Fig. 1
TR-17-159-01



Fig. 2
TR-17-159-02

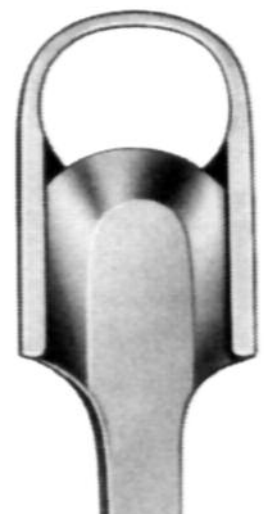
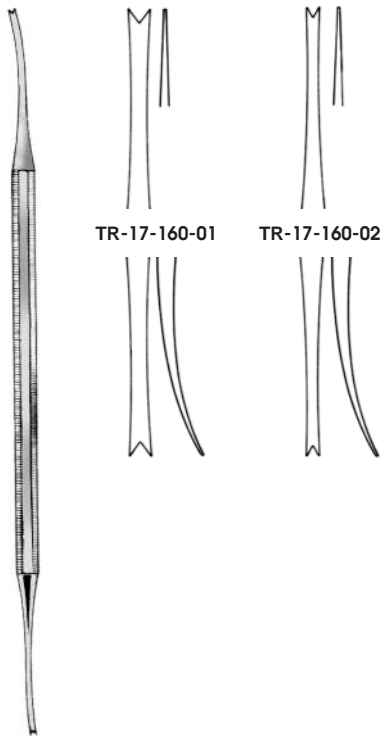
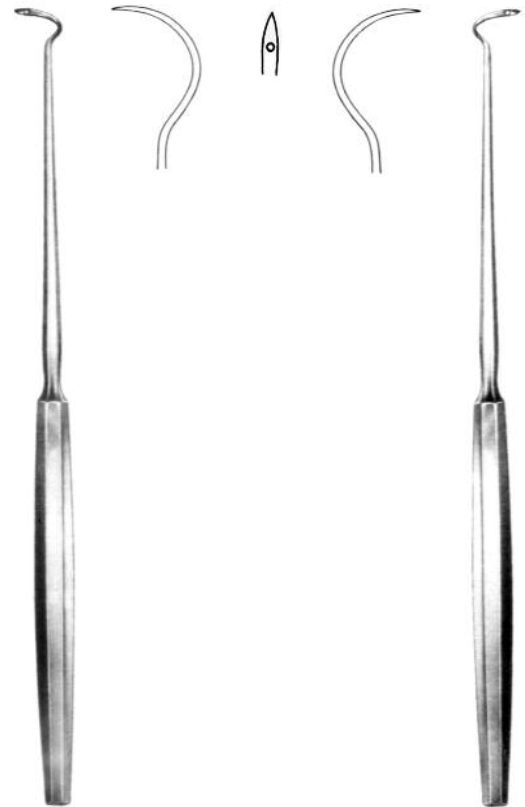

Fig. 3
TR-17-159-03



Luniatschek, 18,0 cm



Hurd
21,0 cm TR-17-163-21

Hurd
21,0 cm TR-17-165-21



Von Eicken
25,0 cm TR-17-167-25

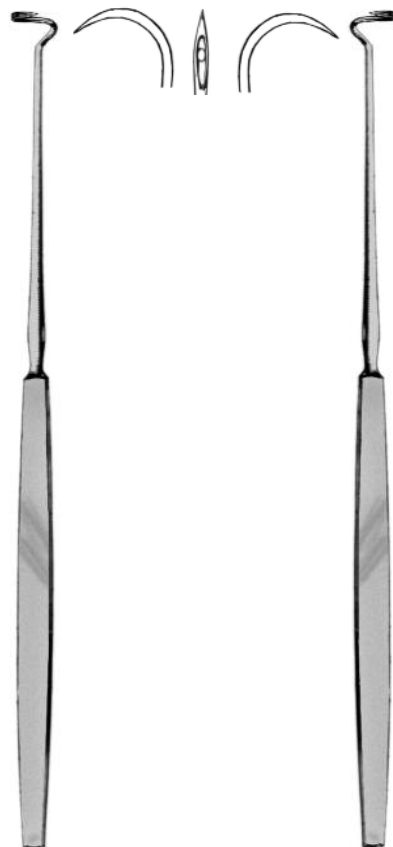

Dupuy Weiss, 22,0 cm
TR-17-169-22 TR-17-171-22

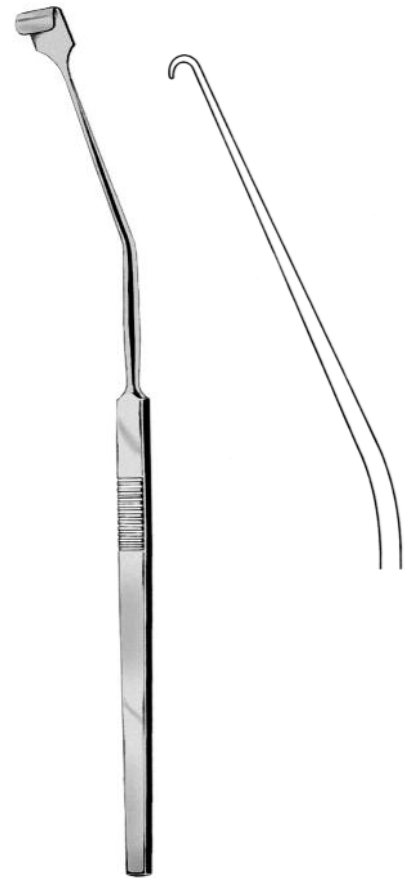

Nager
23,0 cm TR-17-175-23

Adenoid Curettes, Adenotomes



Fig. 1
TR-17-181-01
TR-17-183-01



Fig. 2
TR-17-181-02
TR-17-183-02



Fig. 3
TR-17-181-03
TR-17-183-03



Fig. 4
TR-17-181-04
TR-17-183-04



Fig. 5
TR-17-181-05
TR-17-183-05



Fig. 6
TR-17-181-06
TR-17-183-06



Beckmann, 22,0 cm



TR-17-181-01 - TR-17-181-06 TR-17-183-01 - TR-17-183-06



La Force, 23,0 cm

Fig. 1 TR-17-187-01
Fig. 2 TR-17-187-02
Fig. 3 TR-17-187-03

Spare Blades



Fig. 1
TR-17-187-11



Fig. 2
TR-17-187-12



Fig. 3
TR-17-187-13



- TR-17-200-08
- TR-17-200-10
- TR-17-200-12
- TR-17-200-14
- TR-17-200-16
- TR-17-200-18
- TR-17-200-20
- TR-17-200-22
- TR-17-200-24
- TR-17-200-26
- TR-17-200-28
- TR-17-200-30

- Fig. 00 Ø 8,0 mm
- Fig. 0 Ø 10,0 mm
- Fig. 1 Ø 12,0 mm
- Fig. 2 Ø 14,0 mm
- Fig. 3 Ø 16,0 mm
- Fig. 4 Ø 18,0 mm
- Fig. 5 Ø 20,0 mm
- Fig. 6 Ø 22,0 mm
- Fig. 7 Ø 24,0 mm
- Fig. 8 Ø 26,0 mm
- Fig. 9 Ø 28,0 mm
- Fig. 10 Ø 30,0 mm

- TR-17-210-08
- TR-17-210-10
- TR-17-210-12
- TR-17-210-14
- TR-17-210-16
- TR-17-210-18
- TR-17-210-20
- TR-17-210-22
- TR-17-210-24
- TR-17-210-26
- TR-17-210-28
- TR-17-210-30

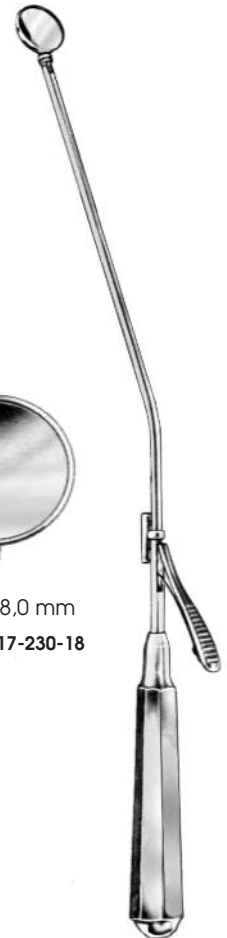

Ø 12,0 mm
TR-17-230-12



Ø 14,0 mm
TR-17-230-14



Ø 16,0 mm
TR-17-230-16



Ø 18,0 mm
TR-17-230-18

11,0 cm
TR-17-201-00

11,0 cm
TR-17-202-00

Michel, 25,0 cm
TR-17-230-12 - TR-17-230-18

Laryngeal Instruments



Reichert
23,0 cm TR-17-241-23

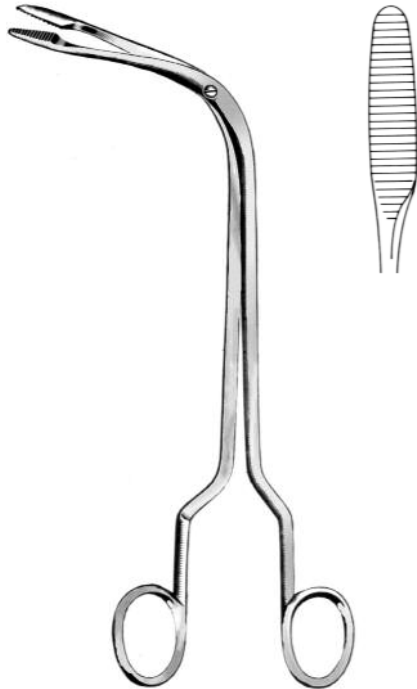

Fränkel
22,0 cm TR-17-247-22



TR-17-251-01



TR-17-251-02



TR-17-251-03



TR-17-251-04

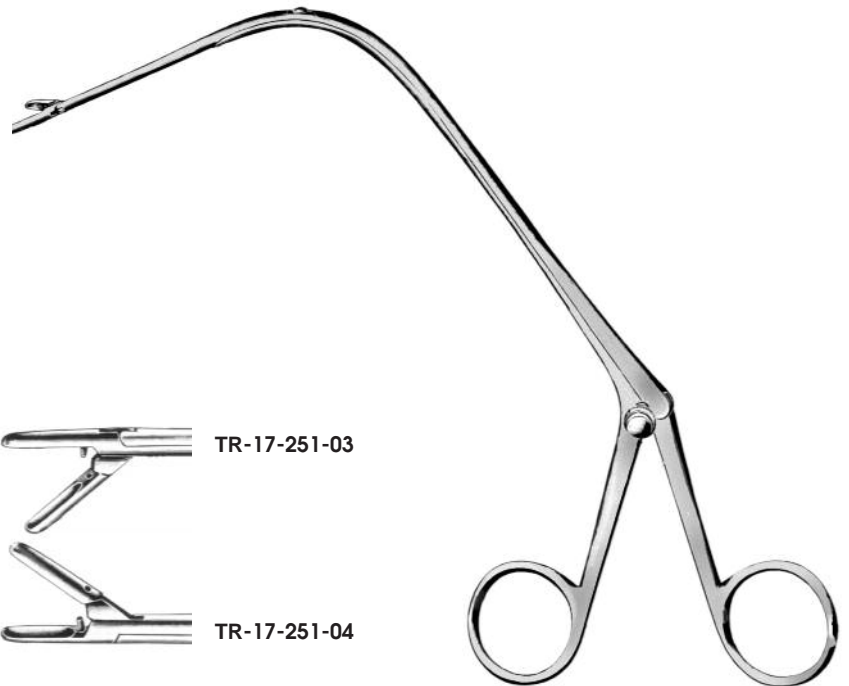

Jurasz, 22,0 cm

Brüning

Straight Tubes with Stylet, stiff

20,0 cm **TR-17-262-20**

30,0 cm **TR-17-262-30**

40,0 cm **TR-17-262-40**



Brünings

Curved Tubes with Stylet, stiff

20,0 cm **TR-17-267-20**

Curved Tubes with Stylet, malleable

20,0 cm **TR-17-268-20**

Fränkel

TR-17-270-01



Kahler

TR-17-270-02



Fränkel

TR-17-270-04



Huber Universal-Griff

TR-17-262-00

Scheinmann

TR-17-270-06



Scheinmann

TR-17-270-15



Brünings

TR-17-270-08

TR-17-270-09



Schumacher

TR-17-270-16



Lange

TR-17-270-11



Cordes

TR-17-270-17



TR-17-270-18



Krause

TR-17-270-13

TR-17-270-14



Rosenberg

TR-17-270-19



Trachea Instruments



Trousseau
12,0 cm TR-17-315-12



Laborde
13,5 cm TR-17-317-13



Iterson, 17,0 cm



TR-17-321-01



TR-17-321-02



Bose, 16,5 cm



TR-17-323-01



TR-17-323-02



Rose
13,5 cm TR-17-325-13



Luer
11,0cm TR-17-327-11



Jackson
15,0 cm TR-17-329-15



News
15,0 cm **TR-17-331-15**



Jackson
17,0 cm **TR-17-335-17**

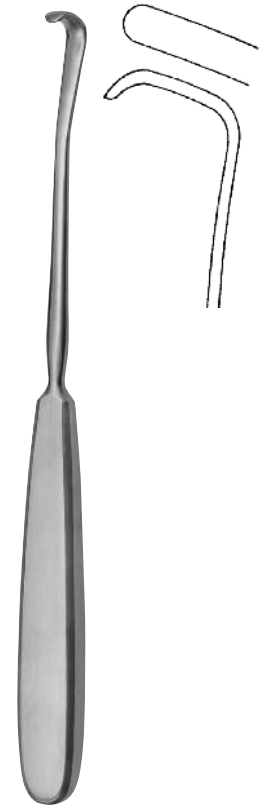

Schoenborn
20,5 cm **TR-17-337-21**



Kocher

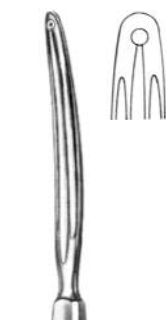







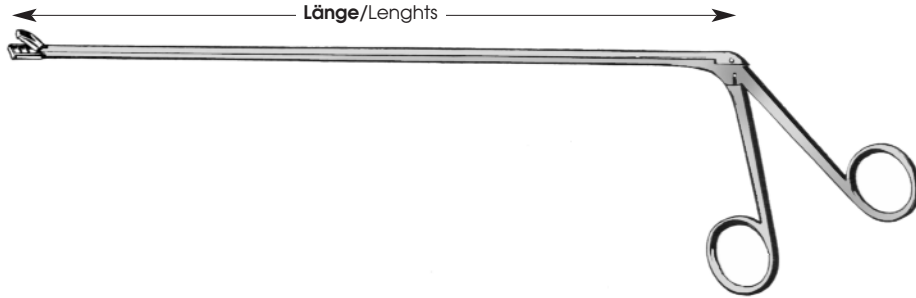

Lahey
15,0 cm **TR-17-340-15**
20,0 cm **TR-17-340-20**



Mastin
15,0 cm **TR-17-341-17**

Broncho- and Esophagoscopy Forceps



	Shaft 30 cm	Shaft 40 cm	Shaft 50 cm	Shaft 60 cm	
	TR-17-410-30	TR-17-410-40	TR-17-410-50	TR-17-410-60	Biopsy Punch
	TR-17-411-30	TR-17-411-40	TR-17-411-50	TR-17-411-60	Biopsy Punch
	TR-17-412-30	TR-17-412-40	TR-17-412-50	TR-17-412-60	Alligator Forceps
	TR-17-413-30	TR-17-413-40	TR-17-413-50	TR-17-413-60	Cup-shaped Forceps
	TR-17-414-30	TR-17-414-40	TR-17-414-50	TR-17-414-60	Biopsy Punch
	TR-17-415-30	TR-17-415-40	TR-17-415-50	TR-17-415-60	Grasping Forceps
	TR-17-416-30	TR-17-416-40	TR-17-416-50	TR-17-416-60	Cup-shaped Forceps



TR-17-504-01



TR-17-504-02



TR-17-504-03



Voltolini



Tieck-Halle



Fig. 1

TR-17-506-01

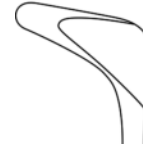
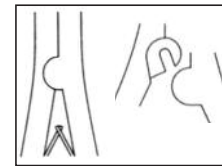

Fig. 2

TR-17-506-02

asepticjoint

screwjoint



aseptic joint

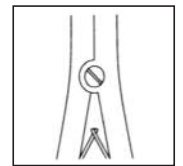

screw joint



Hartmann-Halle



Fig. 1

TR-17-508-01



Fig. 2

TR-17-508-02

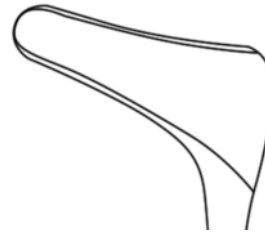

Fig.

TR-17-508-03

3asepticjoint

screwjoint

TR-17-509-01

TR-17-509-02

TR-17-509-03



Fig. 1

TR-17-515-01

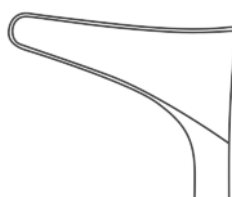

Fig. 2

TR-17-515-02



Fig. 3

TR-17-515-03



Modell Wien

Nasal Specula

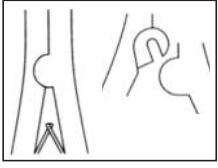

aseptic joint

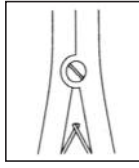

screw joint

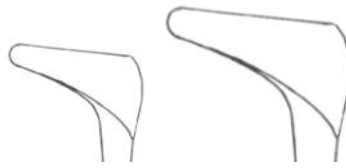

TR-17-519-14

TR-17-519-15



Beckmann

screw joint
aseptic joint

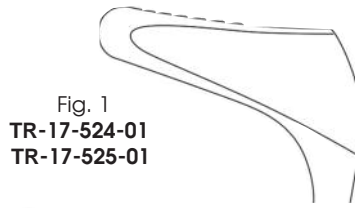

Fig. 1
TR-17-524-01
TR-17-525-01

screw joint
aseptic joint

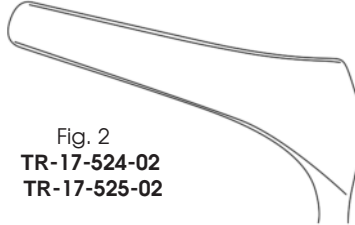

Fig. 2
TR-17-524-02
TR-17-525-02

screw joint
aseptic joint

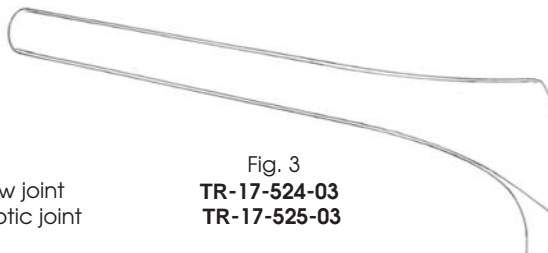

Fig. 3
TR-17-524-03
TR-17-525-03

screw joint
aseptic joint

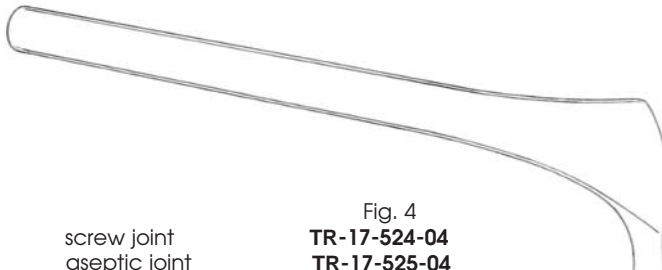

Fig. 4
TR-17-524-04
TR-17-525-04



Killian



Cottle

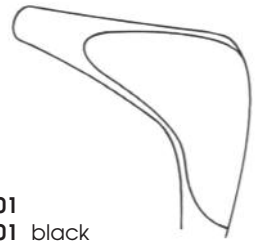

Fig. 1
TR-17-528-01
TR-17-530-01 black

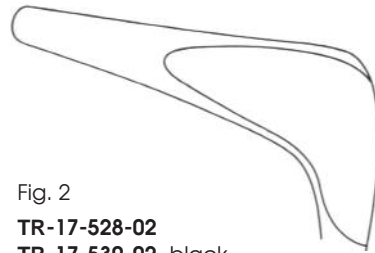

Fig. 2
TR-17-528-02
TR-17-530-02 black

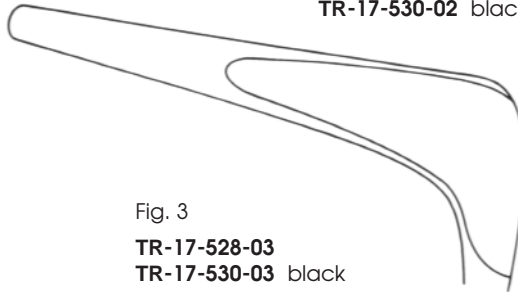

Fig. 3
TR-17-528-03
TR-17-530-03 black

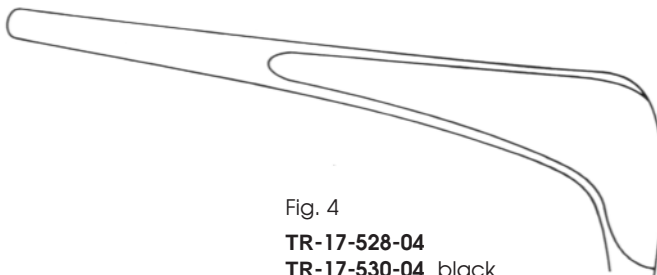

Fig. 4
TR-17-528-04
TR-17-530-04 black

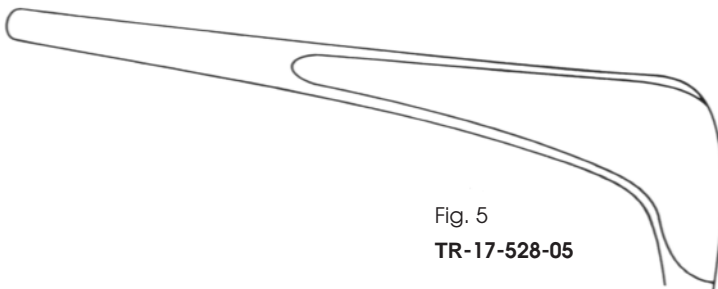

Fig. 5
TR-17-528-05



Cottle

black finish

Tampon and Polypus Forceps



Lubet-Barbon
20,0 cm TR-17-603-20

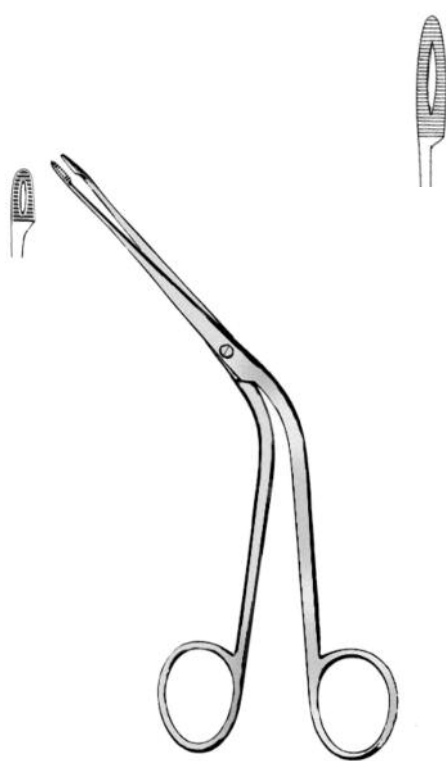

Hartmann
16,0 cm TR-17-607-16



Hartmann
20,0 cm TR-17-607-20



Heymann
18,0 cm TR-17-609-18



Littauer
18,0 cm TR-17-611-18



Krause
26,0 cm TR-17-621-26



TR-17-627-99
0,3 mm Ø

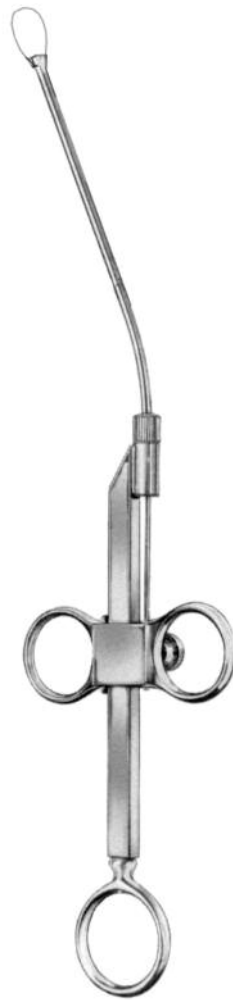

Krause-Voss
26,0 cm TR-17-623-26



Joseph, 14,5 cm

TR-17-640-14

TR-17-641-14

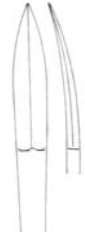

Brünings
16,0 cm TR-17-642-16



Fomon
16,0 cm TR-17-645-16



Freer
15,5 cm TR-17-646-15



Freer
18,5 cm TR-17-646-18



Sichelmesser
Sickle Knife

9,0 cm TR-17-648-01

19,0 cm TR-17-648-02

19,0 cm TR-17-648-03



Rhinoplastic and Nasal Instruments



Converse

16,0 cm **TR-17-649-16**



Joseph

15,0 cm **TR-17-650-15**



Cottle

15,0 cm **TR-17-652-15**



Cottle

15,0 cm **TR-17-654-15**



Halle

18,0 cm **TR-17-655-18**

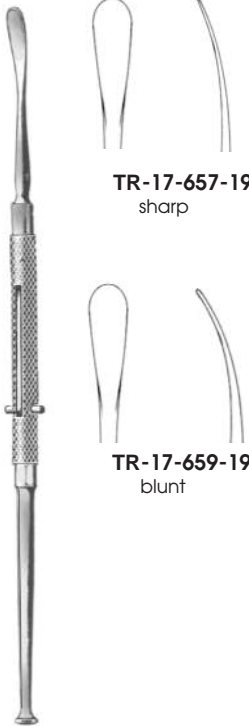

Freer, 19,0 cm

TR-17-657-19
sharp

TR-17-659-19
blunt

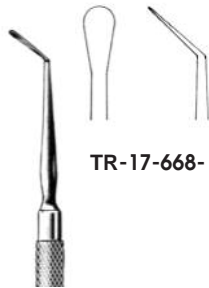

Freer, 19,0 cm

TR-17-668-19



Freer, 19,0 cm

TR-17-669-01

TR-17-669-02



Freer
18,0 cm **TR-17-663-18**

sharp

blunt



Freer
20,0 cm **TR-17-665-20**

sharp

blunt

Septum- and Periosteal Elevators

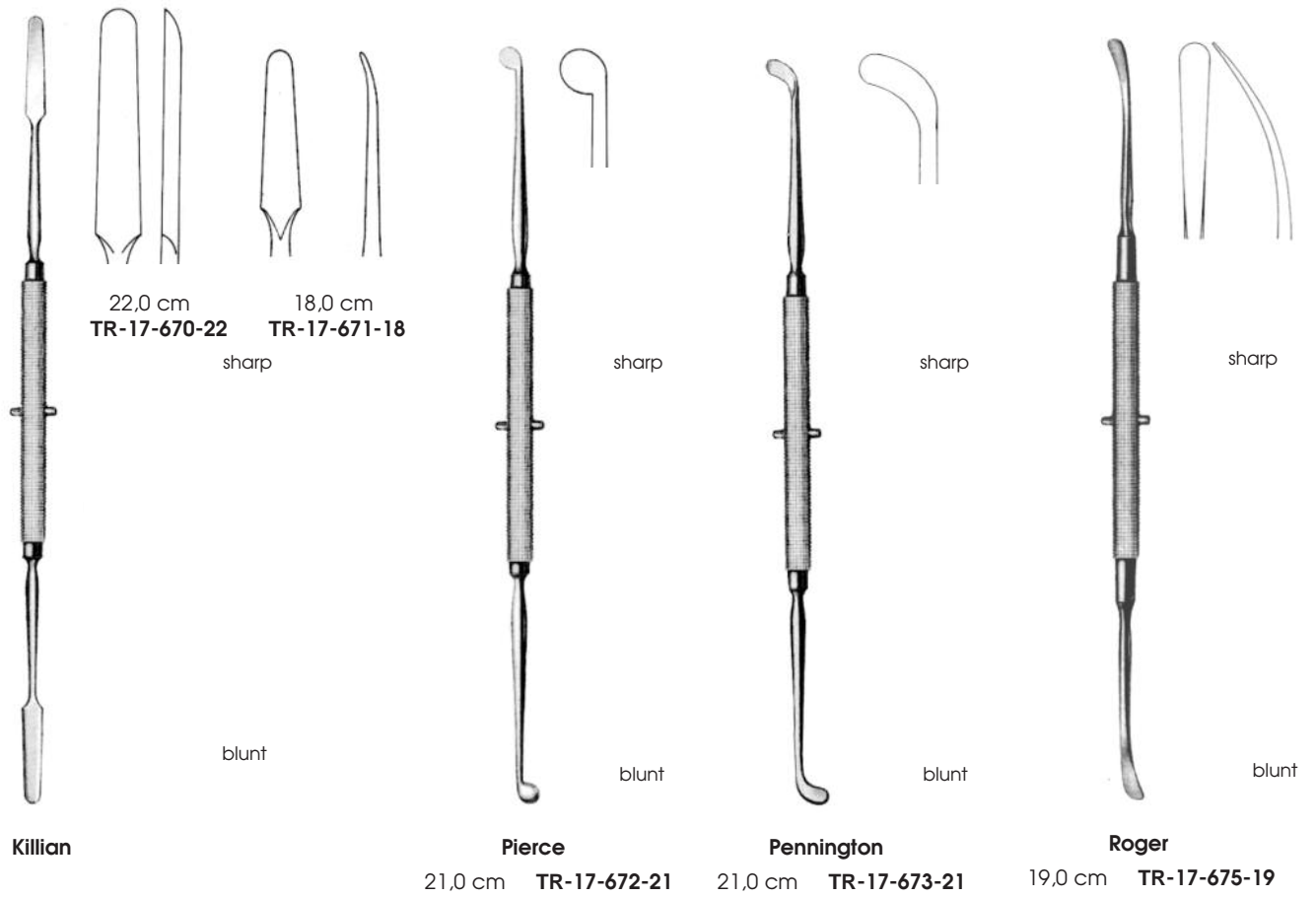

Septum- and Periosteal Elevators



Massing

21,0 cm **TR-17-679-21**



Cottle

21,0 cm **TR-17-681-21**



Cottle

22,0 cm **TR-17-681-22**



McKenty, 15,0 cm

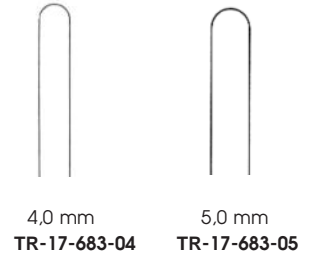

4,0 mm
TR-17-683-04

5,0 mm
TR-17-683-05



Joseph

16,0 cm **TR-17-685-16**

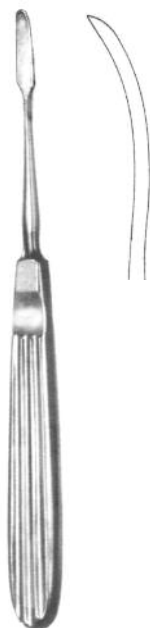

Joseph

16,0 cm **TR-17-687-16**



Joseph

22,0 cm **TR-17-688-22**



Sewall

20,0 cm **TR-17-689-20**



McKenty, 21,0 cm
TR-17-691-21

Cottle, 22,0 cm
TR-17-693-22

Rhinoplastic- and Septum Knives, Swive lKnives

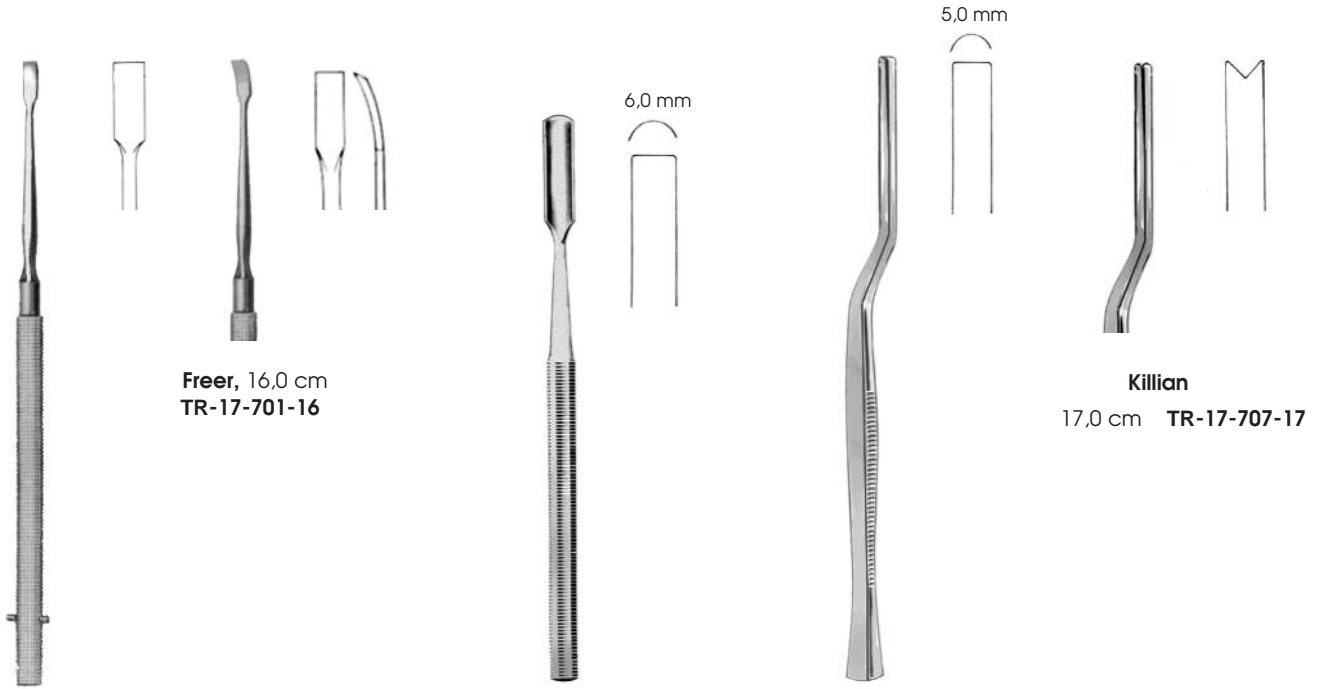

Freer, 16,0 cm
TR-17-701-16

Killian
17,0 cm TR-17-707-17

Freer
16,0 cm TR-17-700-16

Freer
15,0 cm TR-17-702-15

Killian
17,0 cm TR-17-705-17

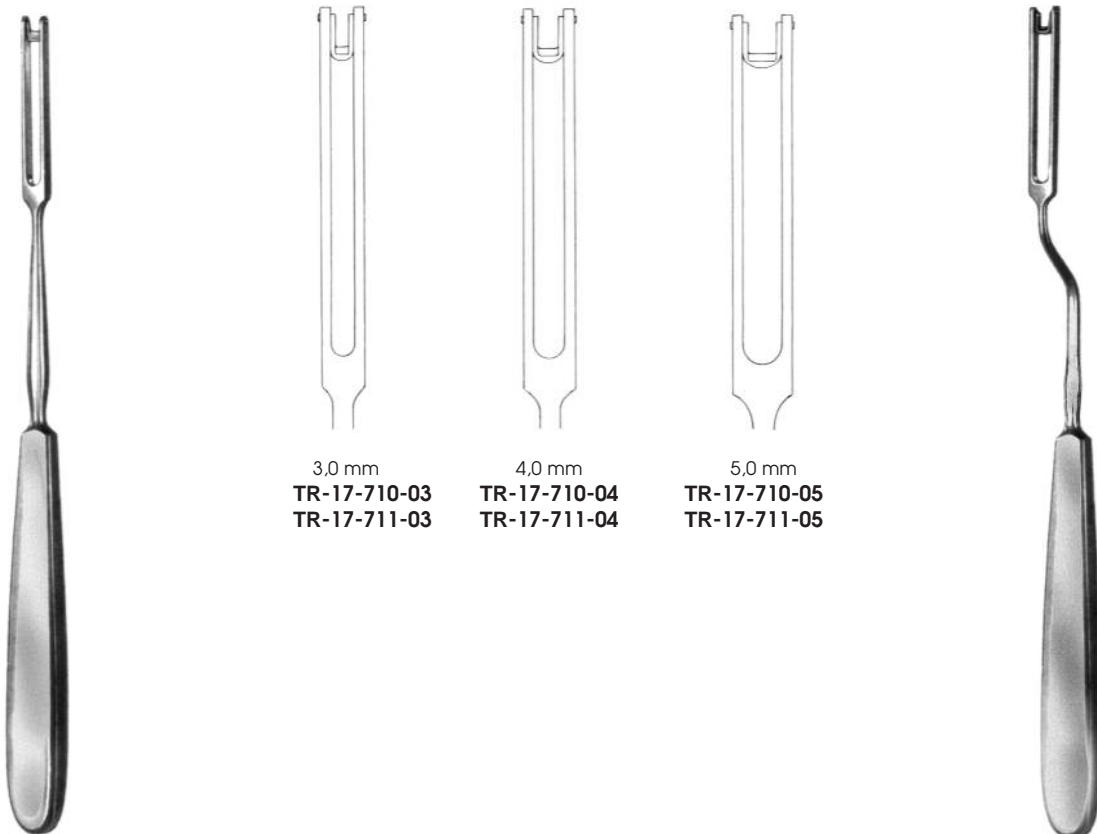

3,0 mm
TR-17-710-03
TR-17-711-03

4,0 mm
TR-17-710-04
TR-17-711-04

5,0 mm
TR-17-710-05
TR-17-711-05

Ballenger
TR-17-710-03 - TR-17-710-05

Ballenger
TR-17-711-03 - TR-17-711-05

Nasal Chisels and Osteotomes

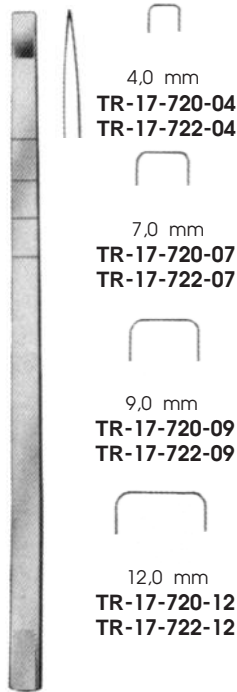

4,0 mm
TR-17-720-04
TR-17-722-04

7,0 mm
TR-17-720-07
TR-17-722-07

9,0 mm
TR-17-720-09
TR-17-722-09

12,0 mm
TR-17-720-12
TR-17-722-12

Cottle, 18,0 cm
TR-17-720-04 - TR-17-720-12

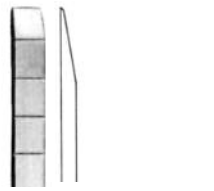

Cottle, 18,0 cm
TR-17-722-04 - TR-17-722-12



Cottle, 18,0 cm
TR-17-721-06

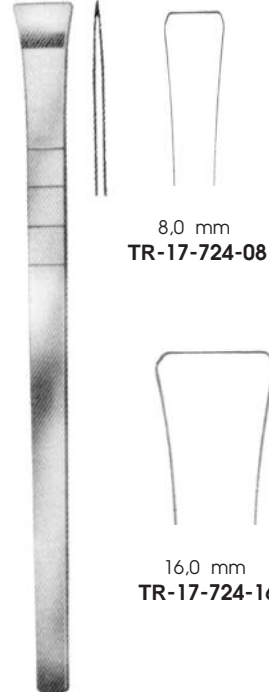

8,0 mm
TR-17-724-08

16,0 mm
TR-17-724-16

Cottle, 18,0 cm
TR-17-724-08 - TR-17-724-16

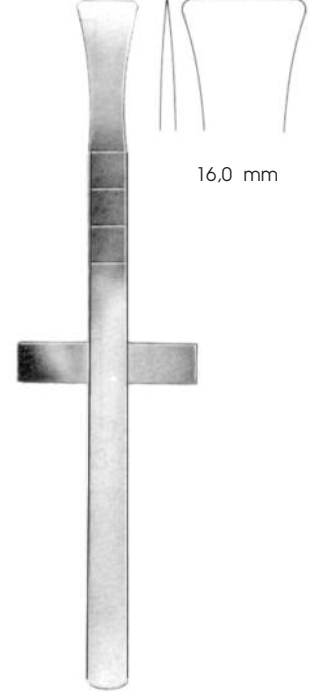

16,0 mm

Cottle, 18,0 cm
TR-17-726-16

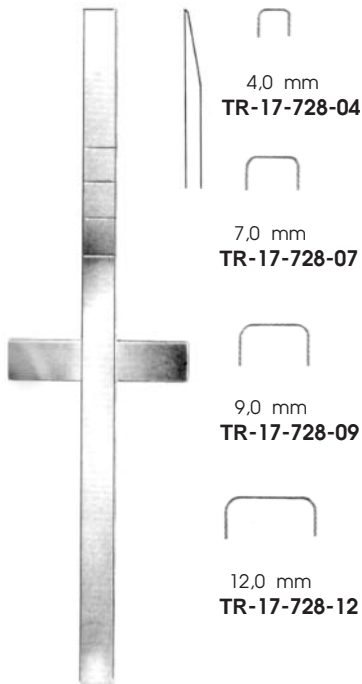

4,0 mm
TR-17-728-04

7,0 mm
TR-17-728-07

9,0 mm
TR-17-728-09

12,0 mm
TR-17-728-12

Cottle, 18,0 cm
TR-17-728-04 - TR-17-728-12

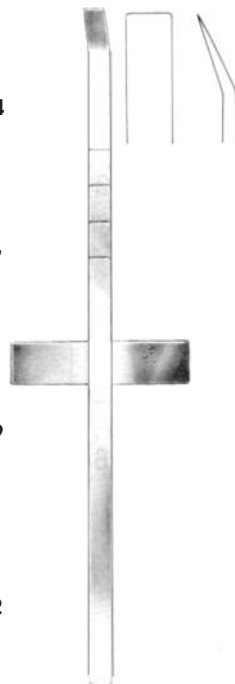

Cottle, 18,0 cm
TR-17-729-06

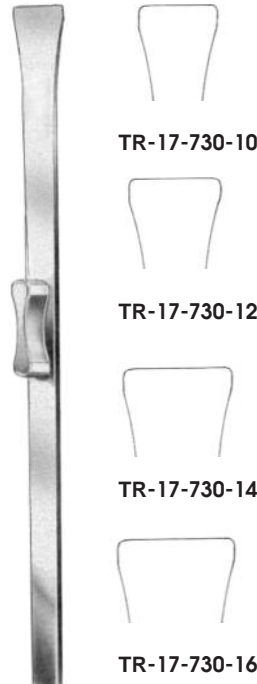

TR-17-730-10

TR-17-730-12

TR-17-730-14

TR-17-730-16

Rubin, 18,0 cm
TR-17-730-10 - TR-17-730-16



3,0 mm
TR-17-732-03

2,0 mm
TR-17-733-02

4,0 mm
TR-17-733-04

9,0 mm
TR-17-733-09

4,0 mm
TR-17-732-04

3,0 mm
TR-17-733-03

7,0 mm
TR-17-733-07

12,0 mm
TR-17-733-12

Walter, 19,0 cm
TR-17-733-09 - TR-17-733-12

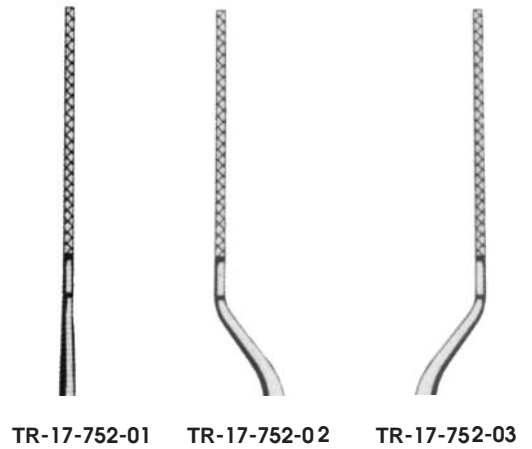
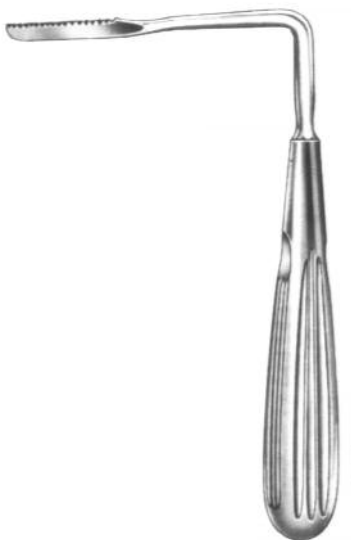
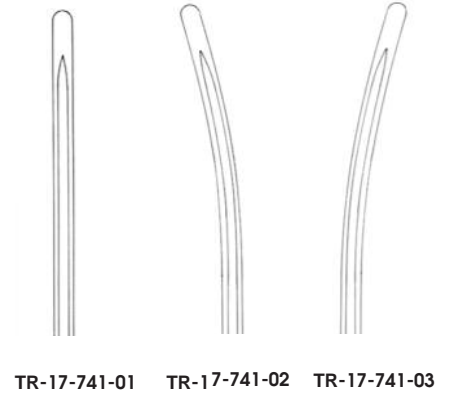
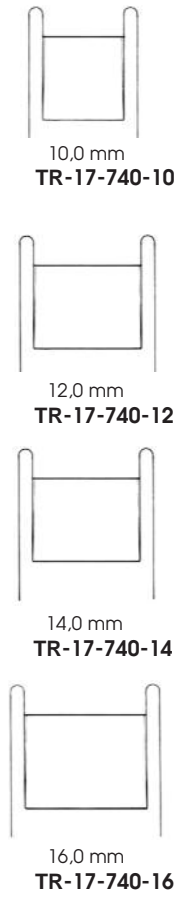

Nasal Instruments and Retractors

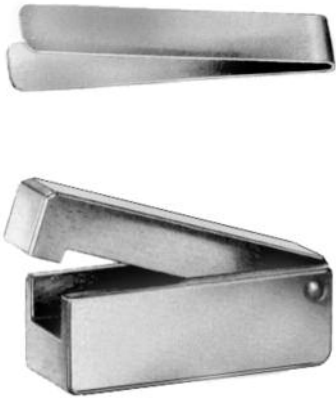

Cottle
Knorpelquetschinstrument
Bone crusher
TR-17-756-00



Columella
10,0 cm TR-17-760-10



Cottle
14,0 cm TR-17-761-14



Graefe
11,0 cm TR-17-762-11



Aufricht
16,0 cm TR-17-767-16



Walter
13,5 cm TR-17-769-



Kilner, 10,0 cm
TR-17-770-10
scharf
sharp
TR-17-770-11
stumpf
blunt



Converse
12,0 cm TR-17-771-12



Cottle, 15,0 cm



TR-17-772-01



TR-17-772-02



TR-17-772-03

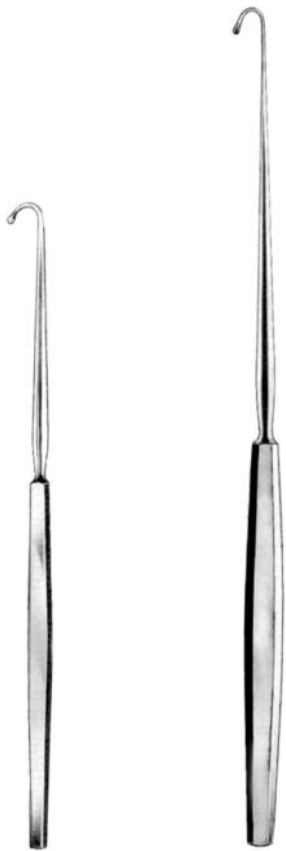

Fomon 17,0 cm **TR-17-776-17** **Lange** 22,0 cm **TR-17-777-22**



Cottle, 15,0 cm



TR-17-778-01



TR-17-778-02



TR-17-778-03



Fomon 16,0 cm **TR-17-779-16**



Cottle 20,0 cm **TR-17-780-20**



Neifert 16,0 cm **TR-17-782-16**



6x12 mm **TR-17-783-01**
10x12 mm **TR-17-783-02**

Massing, 14,0 cm



Cottle 15,0 cm **TR-17-785-15**



Cookley, 17,0 cm



Fig. 1
TR-17-790-01



Fig. 2
TR-17-790-02



Fig. 3
TR-17-790-03



Fig. 4
TR-17-790-04



Fig. 5
TR-17-790-05



Fig. 6
TR-17-790-06

Septum Forceps



TR-17-801-01



TR-17-803-01



TR-17-803-02

Craig, 17,0 cm

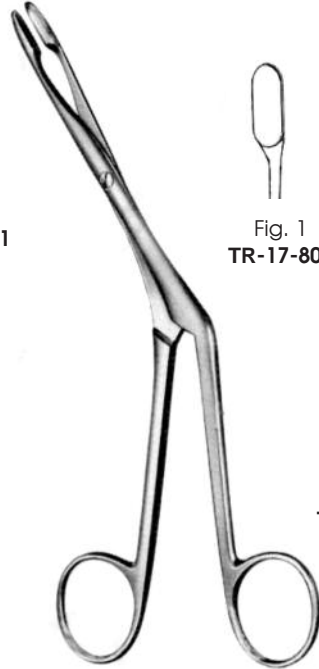

Fig. 1

TR-17-804-01



Fig. 2

TR-17-804-02



Fig. 3

TR-17-804-03

Heymann
18,0 cm TR-17-804-01

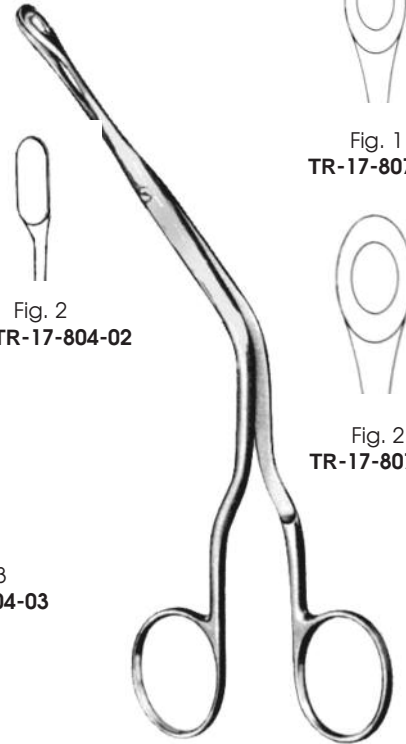

Fig. 1

TR-17-807-01



Fig. 2

TR-17-807-02

Luc, 20,0 cm

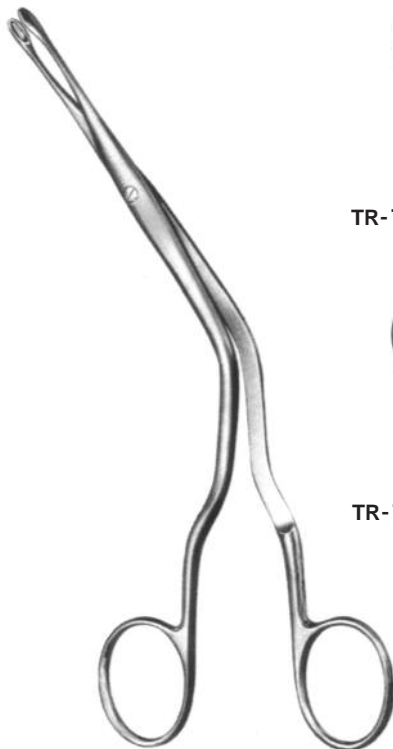

Fig. 1

TR-17-811-01



Fig. 2

TR-17-811-02

Luc, 20,0 cm



Fig. 1

TR-17-813-01



Fig. 2

TR-17-813-02



Fig. 3

TR-17-813-03



Fig. 4

TR-17-813-04

Brünings, 19,0 cm



Ash
22,0 cm TR-17-825-22



Cottle-Walsham, 22,0 cm



Fig. 1
TR-17-826-01



Fig. 2
TR-17-826-02



Fig. 3
TR-17-826-03



Kressner, 22,0 cm



3,0 mm
TR-17-829-03



4,0 mm
TR-17-829-04

Septum Forceps and Scissors



Middleton-Jansen, 19,0 cm



TR-17-830-01



TR-17-830-03

through-cutting

serrated



Caplan
20,0 cm **TR-17-841-20**

serrated



Killian
21,0 cm **TR-17-843-21**











Rubin
21,0 cm **TR-17-845-21**



Blakesley

very delicate

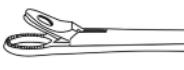
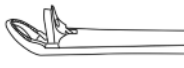
Blakesley Nasal Forceps	 3.0 mm	 3.5 mm	 4.2 mm	
 straight	TR-17-870-30	TR-17-870-35	TR-17-870-42	
 45°	TR-17-871-30	TR-17-871-35	TR-17-871-42	
Blakesley Throughcut Forceps bit	 2.2 mm	 2.5 mm	 3.0 mm	 3.7 mm
 straight	TR-17-880-22	TR-17-880-25	TR-17-880-30	TR-17-880-37
 45°	TR-17-880-22	TR-17-880-25	TR-17-880-30	TR-17-880-37



11

ENT Instruments/Ear

Tuning Forks



Hartmann
with clamps

c	64	TR-18-000-03
c	128	TR-18-000-04
c1	256	TR-18-000-05



Hartmann

c	128	TR-18-001-01
c1	256	TR-18-001-02
c2	512	TR-18-001-03
c3	1024	TR-18-001-04
c4	2048	TR-18-001-05
c5	4096	TR-18-001-06



Lucæ

c	128	TR-18-004-01
c1	256	TR-18-004-02
c2	512	TR-18-004-03
c3	1024	TR-18-004-04
c4	2048	TR-18-004-05
c5	4096	TR-18-004-06

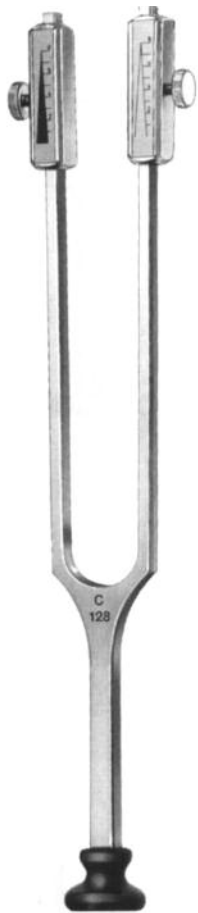

c 64 with clamps
c 128 without clamps

Rydell-Seiffer
c 64/c 128 **TR-18-008-01**



Lucae,
with clamps
c 128 **TR-18-012-01**

c
d
e
f
g
a
h



Hartmann,
with clamps
c 128 **TR-18-013-01**



Hartmann
c1 256 **TR-18-014-01**

Ear Catheters, Politzer Air Bag



Hartmann

- Ø 2,0 mm TR-18-031-01
- Ø 2,5 mm TR-18-031-02
- Ø 3,0 mm TR-18-031-03
- Ø 4,0 mm TR-18-031-04
- Ø 5,0 mm TR-18-031-05



TR-18-031-50



TR-18-034-18



TR-18-034-21



TR-18-034-23

Politzer /complete
TR-18-034-00

With 3 nasal olives TR-18-034-18
TR-18-034-21
TR-18-034-23
TR-18-034-50

Rubber Bulb



Rubber Bulb
TR-18-034-50



Kabierske
complete

TR-18-036-00

with 3 cannulas and rubber bulb

TR-18-042-01
10 ml

complete with protection disc and 2 tips

TR-18-044-05
50 ml

complete with protection disc and 2 tips

TR-18-044-10
100 ml

complete with protection disc and 2 tips



Ear Specula

stainless steel



Politzer
children

TR-18-100-00
TR-18-100-02
TR-18-100-03
TR-18-100-03

Set
ø 2 mm
ø 3 mm
ø 4 mm

ø = inside diameter

stainless steel



Hartmann

TR-18-102-12
TR-18-102-18
TR-18-102-32
TR-18-102-40

Set
ø 1,8 mm
ø 3,2 mm
ø 4,0 mm

TR-18-102-13
TR-18-102-45
TR-18-102-55
TR-18-102-65

Set
ø 4,5 mm
ø 5,5 mm
ø 6,5 mm

stainless steel















Toynbee













TR-18-108-00
TR-18-108-05
TR-18-108-06
TR-18-108-07

Set
ø 5,5 mm
ø 6,5 mm
ø 7,5 mm



Otoskopie-Besteck
TR-18-140-00

 <p>Buck</p>	 Fig. 000	 Fig. 00	 Fig. 0	 Fig. 1	 Fig. 2	 Fig. 3	 Fig. 4
	 blunt TR-18-150-01 TR-18-150-02 TR-18-150-03 TR-18-150-04 TR-18-150-05 TR-18-150-06 TR-18-150-07						
	 blunt TR-18-151-01 TR-18-151-02 TR-18-151-03 TR-18-151-04 TR-18-151-05 TR-18-151-06 TR-18-151-07						
	 sharp TR-18-152-01 TR-18-152-02 TR-18-152-03 TR-18-152-04 TR-18-152-05 TR-18-152-06 TR-18-152-07						
 sharp TR-18-153-01 TR-18-153-02 TR-18-153-03 TR-18-153-04 TR-18-153-05 TR-18-153-06 TR-18-153-07							

 Langenbeck 13,0 cm TR-18-155-13	 Billeau, 16,0 cm  Fig. 1 TR-18-156-01  Fig. 2 TR-18-156-02  Fig. 3 TR-18-156-03	 Shapleigh, 13,0 cm  Fig. 1 TR-18-160-01  Fig. 3 TR-18-160-03	 Jansen 15,0 cm TR-18-162-15  Fig. 2 TR-18-160-02  Fig. 4 TR-18-160-04	 Barth 18,0 cm TR-18-164-18
---	--	--	---	--

Ear Curettes



Gross

12,0 cm **TR-18-165-12**



16,0 cm **TR-18-166-16**



Zaufal

16,0 cm **TR-18-167-16**



Moldenhauer

16,5 cm **TR-18-169-16**

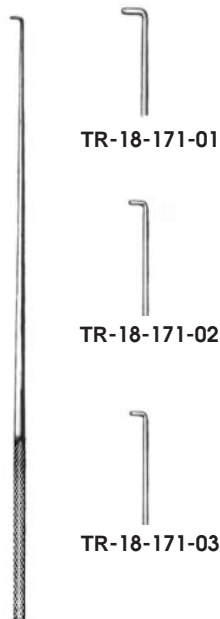

Day, 16,0 cm



Hartmann

16,0 cm **TR-18-175-16**



Lucae, 14,0 cm



Fig. 1

TR-18-177-01



Fig. 2

TR-18-177-02



Fig. 3

TR-18-177-03

Ear Hooks, Foreign Body Instruments



Wagener, 15,0 cm



**Fig. 1
TR-18-179-01**



**Fig. 2
TR-18-179-02**



**Fig. 3
TR-18-179-03**



**Fig. 4
TR-18-179-04**



**Fig. 5
TR-18-179-05**



**Fig. 6
TR-18-179-06**



**Fig. 7
TR-18-179-07**



**Quire
9,0 cm TR-18-200-09**



**Buck
9,0 cm TR-18-202-09**



**Littauer
12,0 cm TR-18-204-12**



Hartmann



12,0 cm

TR-18-206-06











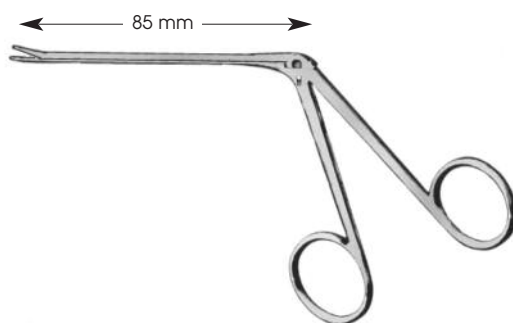



TR-18-206-12



TR-18-208-14

Ear Polypus Forceps



 <p>Hartmann 8,5 cm TR-18-210-08</p>	 <p>Ø 1,0 mm Hartmann-Wullstein 8,5 cm TR-18-212-08</p>	 <p>Hartmann 8,5 cm TR-18-214-08 14,0 cm TR-18-214-14 16,0 cm TR-18-214-16</p>
 <p>Hartmann 8,5 cm TR-18-216-08</p>	 <p>Hartmann 9,0 cm TR-18-218-09</p>	 <p>Hartmann 9,0 cm TR-18-220-09</p>
 <p>Hartmann 8,5 cm TR-18-222-08</p>	 <p>Hartmann 8,5 cm TR-18-224-08</p>	 <p>Hartmann Ø 2,0 mm TR-18-226-01 Ø 2,5 mm TR-18-226-02 Ø 3,0 mm TR-18-226-03</p>
 <p>Ø 3,0 mm Hartmann 8,5 cm TR-18-228-06</p>	 <p>Struempel 8,5 cm TR-18-230-08</p>	 <p>Ø 2,0 mm Hartmann 8,5 cm TR-18-232-08</p>



Muck
15,0 cm **TR-18-300-15**



Politzer
15,0 cm **TR-18-301-15**



Politzer
15,0 cm **TR-18-302-16**



Sexton
17,0 cm **TR-18-305-17** **TR-18-306-17**



Sexton
18,0 cm **TR-18-304-18**



Politzer
16,5 cm **TR-18-308-16**



Politzer
16,5 cm **TR-18-309-16**



Agnew
17,5 cm **TR-18-312-17**

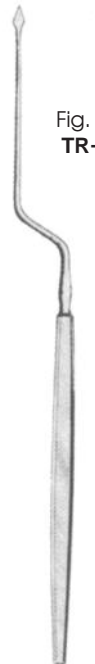

Lucae

Fig. 1 16,0 cm
TR-18-314-01

Fig. 2 18,0 cm
TR-18-314-02

Fig. 3 18,0 cm
TR-18-314-03
Needle horizontal

TR-18-311-16
Needle horizontal

Ear Elevators, -Raspatories, -Snares



TR-18-318-01

TR-18-318-02

TR-18-318-03



Lempert, 19,0 cm



6,0 mm



Lempert

18,0 cm TR-18-320-18



6,0 mm



Lempert

20,0 cm TR-18-320-20



Krause, 16,0 cm



TR-18-351-16



TR-18-353-16

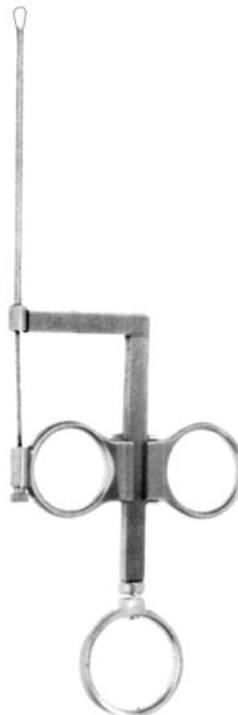

Glegg
16,0 cm TR-18-355-16

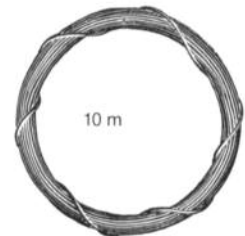

10 mm

Ø 3,0 mm TR-18-358-30
Ø 4,0 mm TR-18-358-40



Pack. = 12 Stck./Pcs. TR-18-359-12
Pack. = 100 Stck./Pcs. TR-18-359-99



smooth jaw

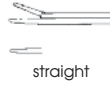

straight

TR-18-400-01

4,0 x 0,8 mm



serrated jaw



straight

TR-18-400-02



curved up

TR-18-400-03



right curved

TR-18-400-04



left curved

TR-18-400-05

← 80 mm →



smooth jaw

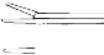

straight

TR-18-402-01

4,0 x 0,6 mm



serrated jaw



straight

TR-18-402-02



3,0 x 0,6 mm



curved up

TR-18-402-03



right curved

TR-18-402-04



left curved

TR-18-402-05

Micro Ear Forceps



3,5 x 0,6 mm

smooth jaw



straight

McGee
TR-18-404-01



3,5 x 0,6 mm

serrated jaw



straight

McGee
TR-18-404-02

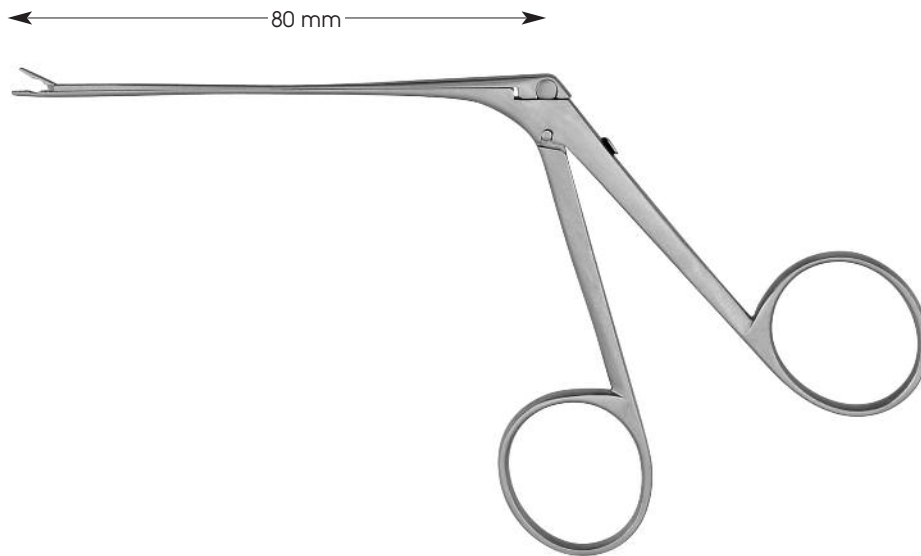

1,0 x 0,9 mm



straight

TR-18-406-01



curved up

TR-18-406-02

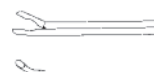

right curved

TR-18-406-03

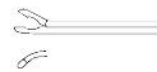

left curved

TR-18-406-04



straight

TR-18-406-11



curved up

TR-18-406-12

very delicate

0,6 x 0,5 mm



straight

TR-18-408-01



curved up

TR-18-408-02



right curved

TR-18-408-03



left curved

TR-18-408-04

Micro Ear Scissors and Wire closure Forceps

Bellucci

4,0 x 0,8 mm

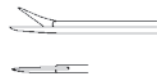

straight

TR-18-412-01

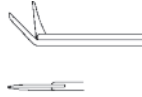

curved up

TR-18-412-02

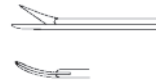

right curved

TR-18-412-03

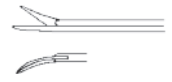

left curved

TR-18-412-04

80 mm



3:1

serrated jaw

Greven



straight

TR-18-420-01



3:1

downwards curved

TR-18-420-02



3:1



downwards curved
3,5 x 0,8 mm

TR-18-422-01



downwards curved
6,0 x 0,8 mm

TR-18-422-02

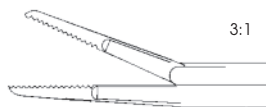

3:1

Juers



left curved

TR-18-424-01



right curved

TR-18-424-02

Micro Ear Forceps and Scissors

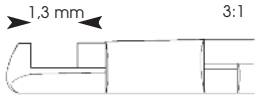

straight downwards
TR-18-426-01



straight upwards
TR-18-426-02



right
TR-18-426-03



left
TR-18-426-04

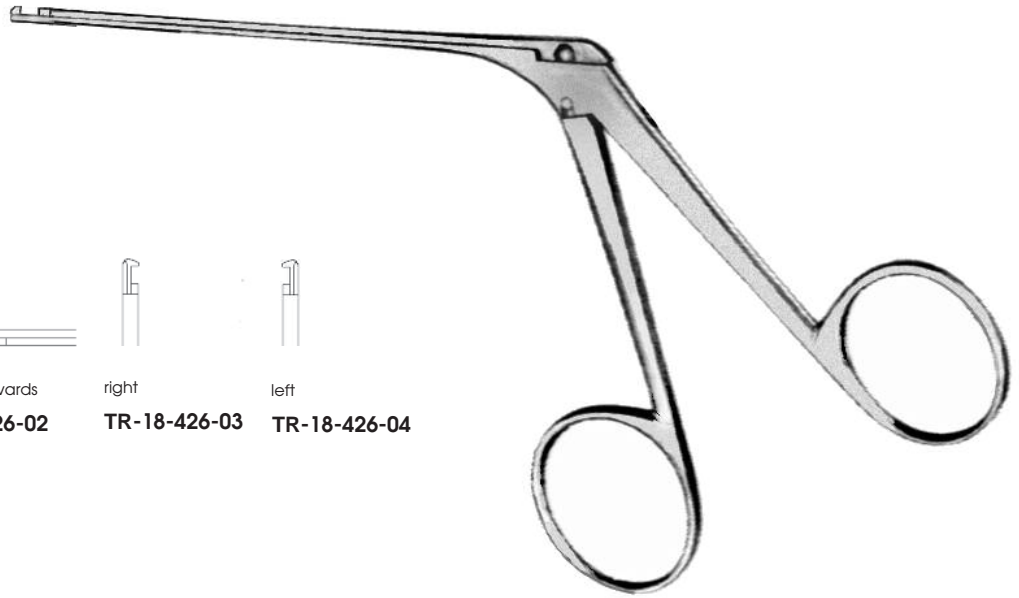

House-Dieter

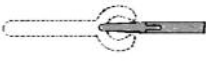

Introduction Forceps
TR-18-428-01

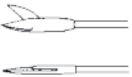

straight, sharp
TR-18-454-01



curved up, blunt
TR-18-454-02

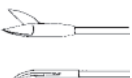

left curved, sharp
TR-18-454-03

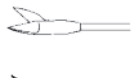

right curved, sharp
TR-18-454-04



Bellucci

Micro Ear Forceps

Dieter

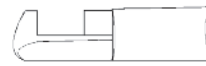

Mc Gee



jaw 3,0 mm



jaw 5,0 mm

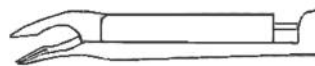

Micro Ear-Instruments



Discision Knife
TR-18-500-01



Sickle Knife
TR-18-500-02



Tabb
Mukosa Knife
TR-18-500-04



Flap Knife
3,0 mm **TR-18-501-01**
3,5 mm **TR-18-501-02**



16,0 cm



Roller Knife, parallel
TR-18-502-01



Roller Knife, right angled
TR-18-502-02



Rosen
Lanzettmesser
Lancet Knife
TR-18-503-01



Rosen
Rundschnittmesser
Flap Knife
45° Ø 3,0 mm **TR-18-503-02**
45° Ø 2,8 mm **TR-18-503-03**
45° Ø 2,6 mm **TR-18-503-04**
45° Ø 2,0 mm **TR-18-503-05**
45° Ø 1,6 mm **TR-18-503-06**
45° Ø 1,4 mm **TR-18-503-07**
45° Ø 1,0 mm **TR-18-503-08**



Rosen
Flap Knife
90° Ø 1,0 mm **TR-18-503-14**
90° Ø 1,5 mm **TR-18-503-09**
90° Ø 2,0 mm **TR-18-503-11**
90° Ø 2,3 mm **TR-18-503-12**
90° Ø 2,5 mm **TR-18-503-13**
90° Ø 3,0 mm **TR-18-503-10**



Raspatory
6x2 mm **TR-18-504-01**



Raspatory
12x1 mm **TR-18-504-02**



Raspatory
1,8 mm **TR-18-504-03**

Micro Ear-Instruments



Raspatory
1,0 mm **TR-18-504-04**



Plester
Applicator
TTR-18-504-05



Dissector, left
TR-18-504-06



Dissector, right
TR-18-504-07



16,0 cm



Roosen
Curette
2,0 mm **TR-18-504-08**



Roosen
Hook
0,6 mm **TR-18-504-09**



Roosen
Raspatory
1,8 mm **TR-18-504-10**



Micro Hook
0,6 mm **TR-18-504-11**



Micro Hook
90° **TR-18-504-12**



Plester
Micro Hook
45° **TR-18-504-14**



Fisch
left curved
TR-18-504-18



Fisch
right curved
TR-18-504-19

Micro Ear-Instruments



House

- 3,5 mm **TR-18-506-35**
- 4,0 mm **TR-18-506-40**
- 4,5 mm **TR-18-506-45**
- 5,0 mm **TR-18-506-50**



Micro Needle
TR-18-510-01



Micro Needle
TR-18-510-02



Micro Needle
TR-18-510-03



16,0 cm



25°



45°



90°

Micro Needle
TR-18-510-04

Shambough

- 0,3 mm **TR-18-510-05**
- 0,5 mm **TR-18-510-06**
- 0,6 mm **TR-18-510-07**

Shambough

- 0,4 mm **TR-18-510-08**
- 0,6 mm **TR-18-510-09**
- 0,8 mm **TR-18-510-10**
- 1,0 mm **TR-18-510-11**
- 1,2 mm **TR-18-510-54**
- 1,5 mm **TR-18-510-55**
- 2,0 mm **TR-18-510-56**
- 2,5 mm **TR-18-510-57**

Shambough

- 0,4 mm **TR-18-510-12**
- 0,6 mm **TR-18-510-13**
- 0,8 mm **TR-18-510-14**
- 1,0 mm **TR-18-510-15**
- 1,2 mm **TR-18-510-64**
- 1,5 mm **TR-18-510-65**
- 2,0 mm **TR-18-510-66**
- 2,5 mm **TR-18-510-67**



Micro Hook
TR-18-510-16



Plester
Scraper
TR-18-510-17



Gerlach
Micro Hook
TR-18-510-22

Micro Ear-Instruments



16,0 cm



90°

Micro Hook
0,3 mm **TR-18-511-01**
0,6 mm **TR-18-511-02**
1,0 mm **TR-18-511-03**



90°

Micro Hook
0,3 mm **TR-18-511-11**
0,6 mm **TR-18-511-12**
1,0 mm **TR-18-511-13**



90°

Micro Hook
0,5 mm **TR-18-513-02**
1,0 mm **TR-18-513-03**



90°

Micro Hook
0,5 mm **TR-18-513-12**
1,0 mm **TR-18-513-13**



Micro Hook
TR-18-514-01



Micro Hook
TR-18-515-01



25°

Micro Hook
0,3 mm **TR-18-517-01**
0,6 mm **TR-18-517-02**
1,0 mm **TR-18-517-03**



25°

Micro Hook
0,3 mm **TR-18-517-11**
0,6 mm **TR-18-517-12**
1,0 mm **TR-18-517-13**



45°

Micro Hook
0,3 mm **TR-18-517-21**
0,6 mm **TR-18-517-22**
1,0 mm **TR-18-517-23**



45°

Micro Hook
0,3 mm **TR-18-517-31**
0,6 mm **TR-18-517-32**
1,0 mm **TR-18-517-33**

Micro Ear-Instruments



Shea
16,0 cm TR-18-520-01



Shea
16,0 cm TR-18-521-01



TR-18-522-01
Ø 1,0/1,2 mm

TR-18-522-02
Ø 1,5/1,8 mm



TR-18-522-03
Ø 1,0/1,2 mm

TR-18-522-04
Ø 1,5/1,8 mm



House
17,0 cm TR-18-522-05



Heermann
TR-18-530-00



Heermann
TR-18-530-01



TR-18-530-02



TR-18-530-03

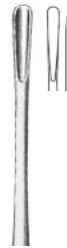

TR-18-530-04



TR-18-530-05



Heermann
19,5 cm TR-18-532-19



12

Thorax and Lung Instruments

Rib Instruments

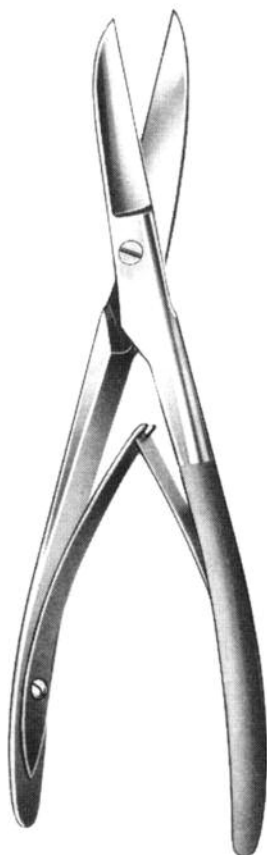

Rib shear plain (Scissor)
23,0 cm TR-21-100-23



Stille
22,0 cm TR-21-101-22



Gluck
22,0 cm TR-21-103-22

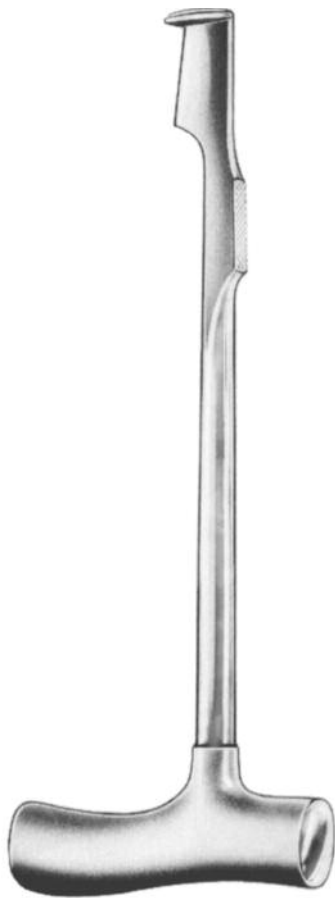

Lebsche
24,0 cm TR-21-109-24

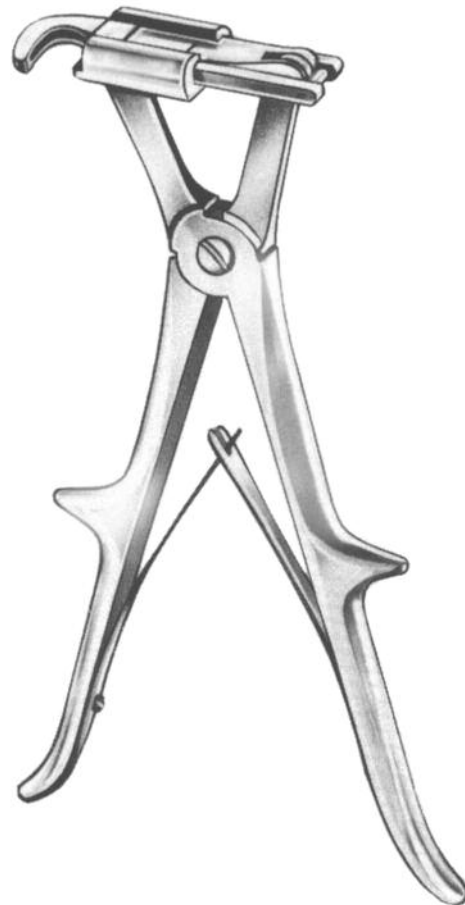

Sauerbruch
24,0 cm TR-21-110-24
27,0 cm TR-21-110-27

Rib Instruments

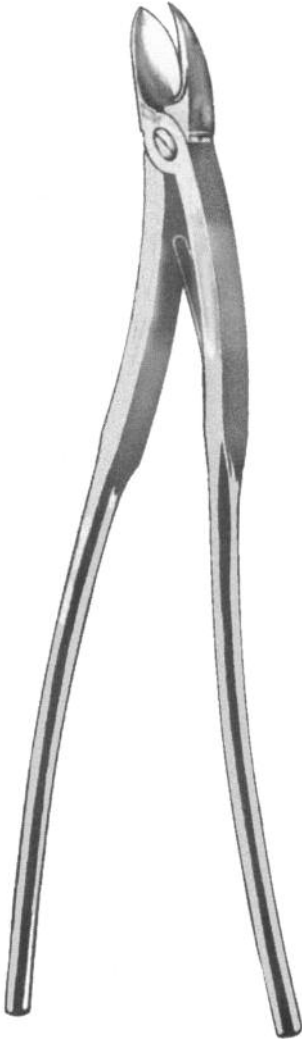

Bethune
34,0 cm TR-21-111-34



Sauerbruch-Frey
34,0 cm TR-21-112-37

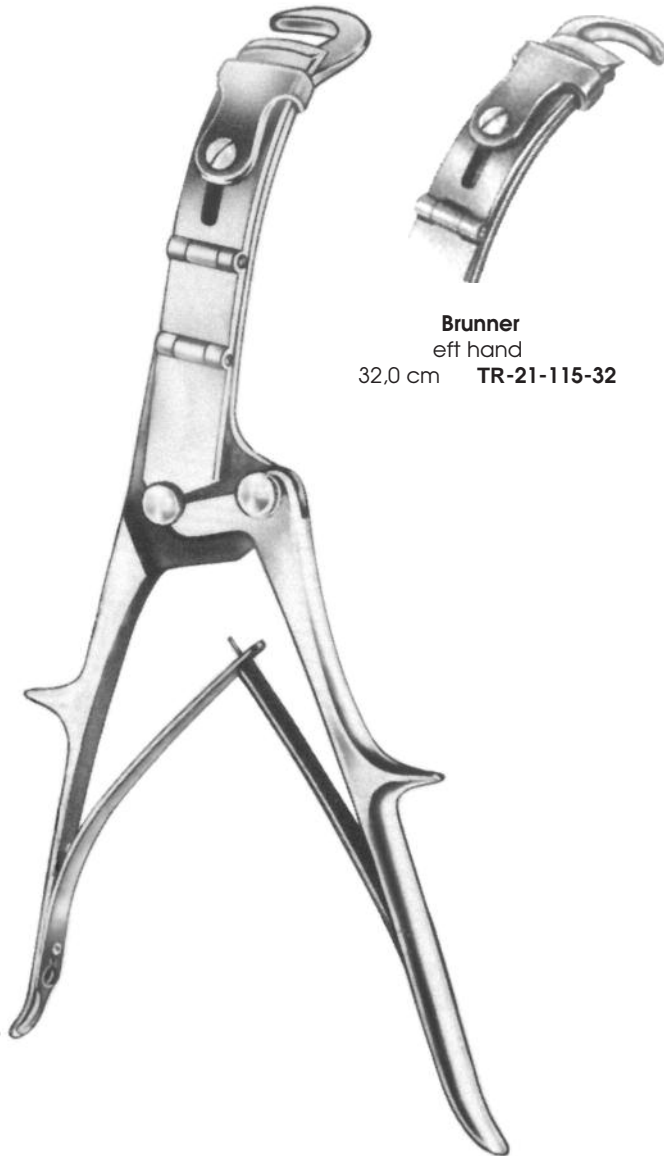

Brunner
left hand
32,0 cm **TR-21-115-32**



Brunner
right hand
32,0 cm **TR-21-113-32**

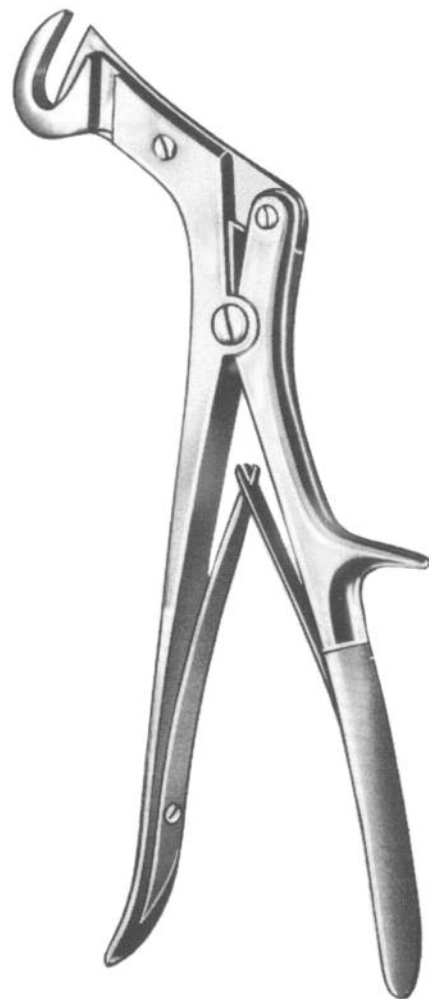

Giertz
27,0 cm **TR-21-117-27**

Rip Spreader

Measurement of blades and spreader

blade size

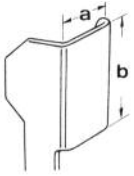

total spread

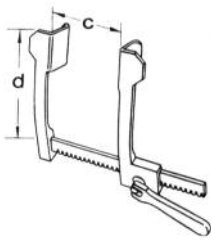

Cooley

		a	b	c	d
TR-21-201-00	mm	12	16	85	55
TR-21-202-00	mm	15	30	115	80
TR-21-203-00	mm	20	45	140	110



Cooley

		a	b	c	d
TR-21-204-00	mm	30	50	185	145

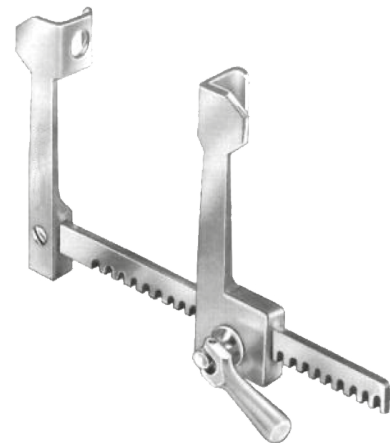

Finoccietto

		a	b	c	d
TR-21-205-00	mm	12	15	70	55
TR-21-206-00	mm	27	30	95	80

Rip Spreader

Measurement of blades and spreader

blade size

total spread

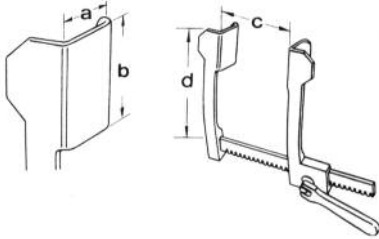

Finocchetto

		a	b	c	d
TR-21-207-00	mm	30	45	140	110
TR-21-208-00	mm	42	62	170	140
TR-21-209-00	mm	73	65	170	140



		a	b	c	d
TR-21-210-00	mm	10	15	120	105



Castaneda

		a	b	c	d
TR-21-211-00	mm	16	30	65	55
TR-21-212-00	mm	12	45	72	80
TR-21-213-00	mm	15	60	100	125

Rip Spreader

Measurement of blades and spreader

blade size

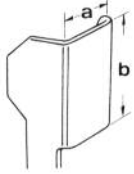

total spread

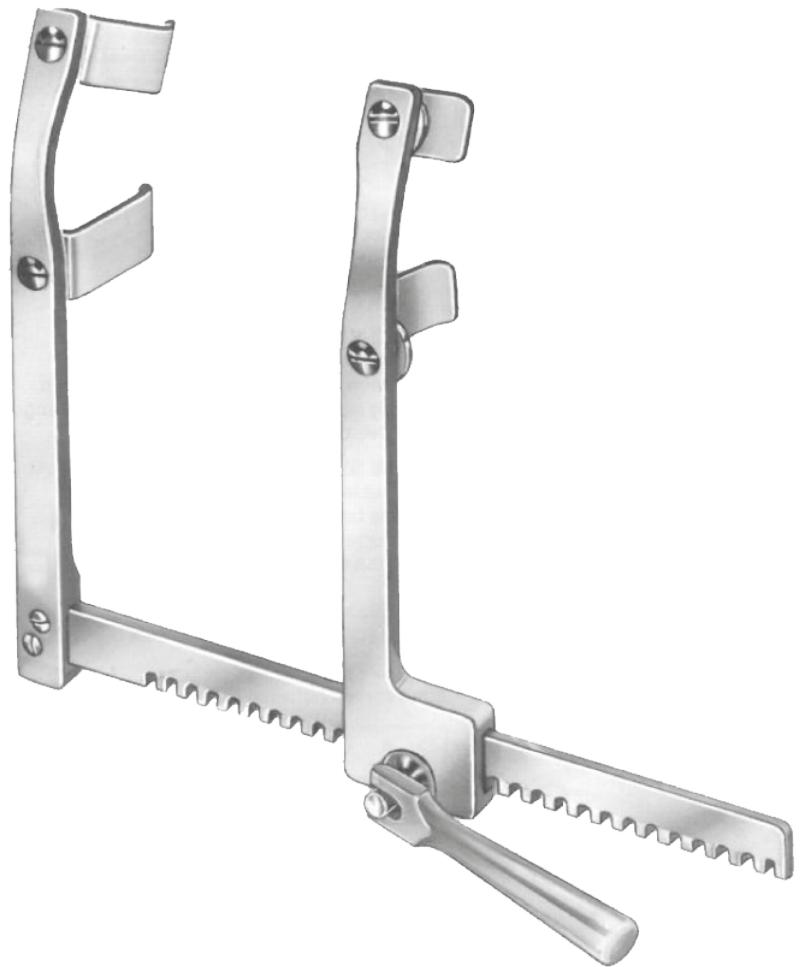
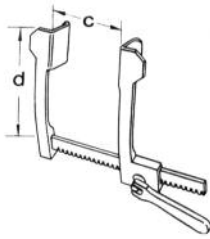

Morse

	a	b	c	d
TR-21-214-00	mm 20	28	210	155



Morse

	a	b	c	d
TR-21-221-00	mm 20	20	155	120

Measurement of blades and spreader

blade size

total spread

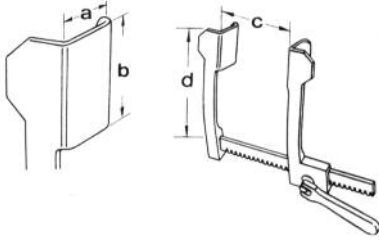

Burford

pair of blades

		a	b
TR-21-222-01	mm	30	42
TR-21-222-02	mm	41	42



Burford

pair of blades

		a	b
TR-21-223-03	mm	45	62
TR-21-223-04	mm	65	62



Burford

with 2 pairs of blades

		1. Pair		2. Pair		c	d
		a1	b1	a2	b2		
TR-21-222-00	mm	30	42	41	42	130	117
TR-21-223-00	mm	45	62	65	62	165	200
TR-21-224-00	mm	45	62	65	62	250	200
TR-21-225-00	mm	45	62	65	62	290	200

Measurement of blades and spreader

blade size

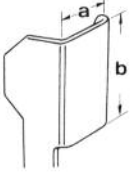

total spread

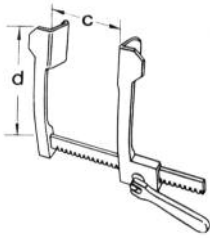

Rip Spreader



Tuffier

	a	b	c	d
TR-21-231-00	mm 42	45	175	110

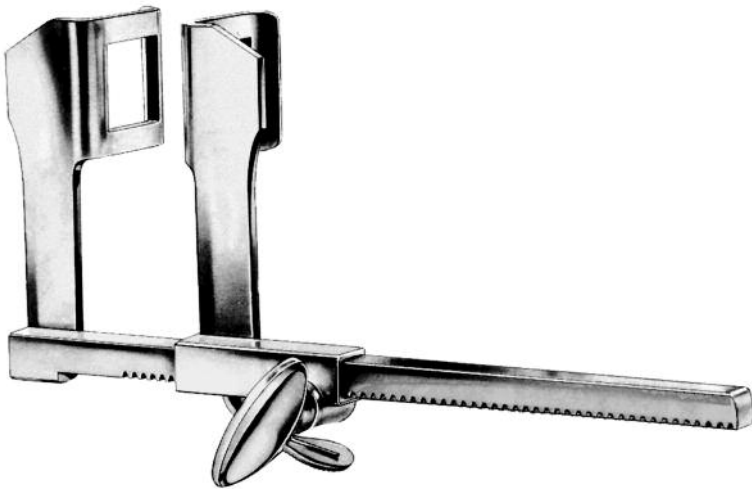

Haight

	a	b	c	d
TR-21-233-00	mm 30	30	120	90

Measurement of blades and spreader

blade size

total spread

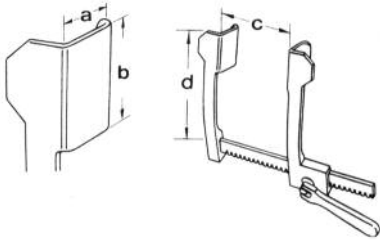

Chevalier

	a	b	c	d
TR-21-234-00	mm 27	100	190	185

Rip Spreader

Measurement of blades and spreader

blade size

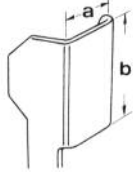

total spread

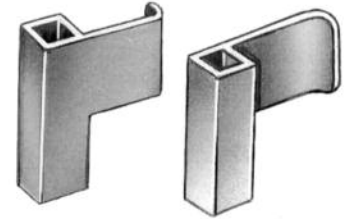
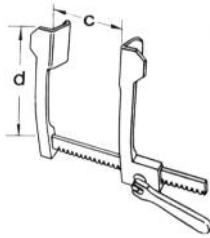

Struck

with two pairs of blades

	1. pair		2. pair		c	d
	a1	b1	a2	b2		
TR-21-235-00	mm	15	20	20	70	55

Struck

pair of blades

		a	b
TR-21-235-01	mm	10	10
TR-21-235-02	mm	10	15
TR-21-235-03	mm	10	20
TR-21-235-04	mm	15	20
TR-21-235-05	mm	20	20

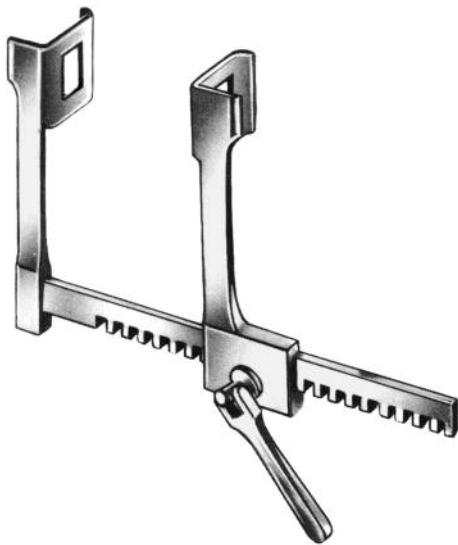

Finoccietto

		a	b	c	d
TR-21-237-00	mm	12	15	70	55



Finoccietto

		a	b	c	d
TR-21-240-00	mm	30	45	140	110
TR-21-241-00	mm	42	62	185	140
TR-21-243-00	mm	73	65	185	140

Measurement of blades and spreader

blade size

total spread

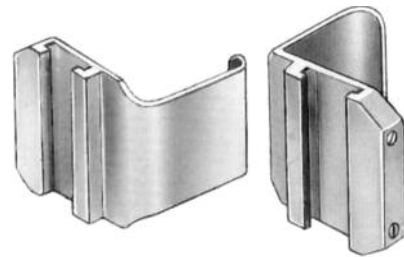
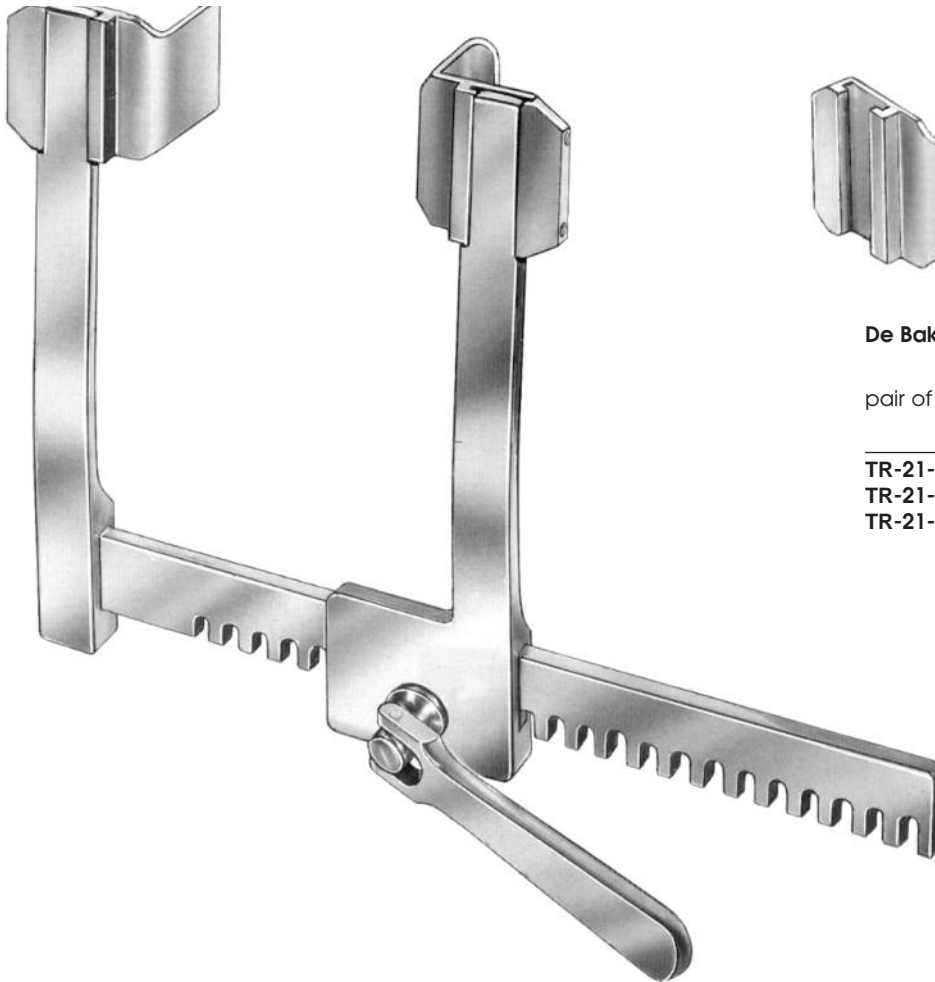
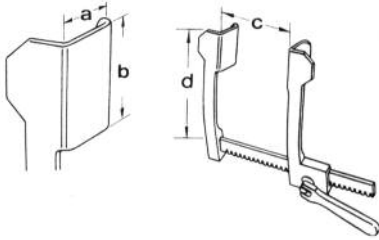

De Bakey

pair of blades

		a	b
TR-21-245-03	mm	30	30
TR-21-245-04	mm	40	40
TR-21-245-05	mm	50	50

De Bakey

		c	d
TR-21-245-00	mm	175	145

complete
consisting of:

TR-21-245-01 RipSpreader, only

TR-21-245-03 pair
TR-21-245-04 pair
TR-21-245-05 pair

Rip Spreader

Measurement of blades and spreader

blade size

total spread

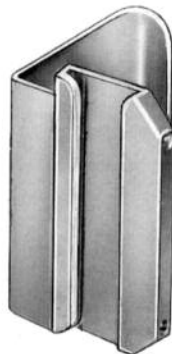
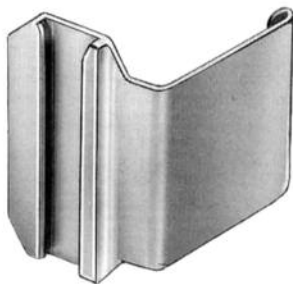
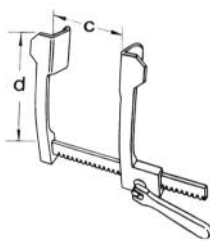
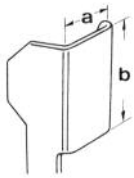

De Bakey

pair of blades

	a	b
TR-21-246-02	mm 55	60
TR-21-246-03	mm 60	60
TR-21-246-04	mm 50	80
TR-21-246-05	mm 40	100
TR-21-246-06	mm 80	60

De Bakey

	c	d
TR-21-246-00	mm 200	185

complete
consisting of:

TR-21-246-01 **RipSpreader,only**

TR-21-246-02	pair
TR-21-246-03	pair
TR-21-246-04	pair
TR-21-246-05	pair
TR-21-246-06	pair

Measurement of blades and spreader

blade size

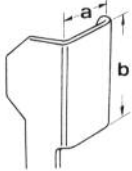

total spread

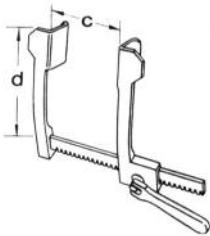

Cooley

	a	b	c	d
TR-21-247-00	mm 20	45	140	110

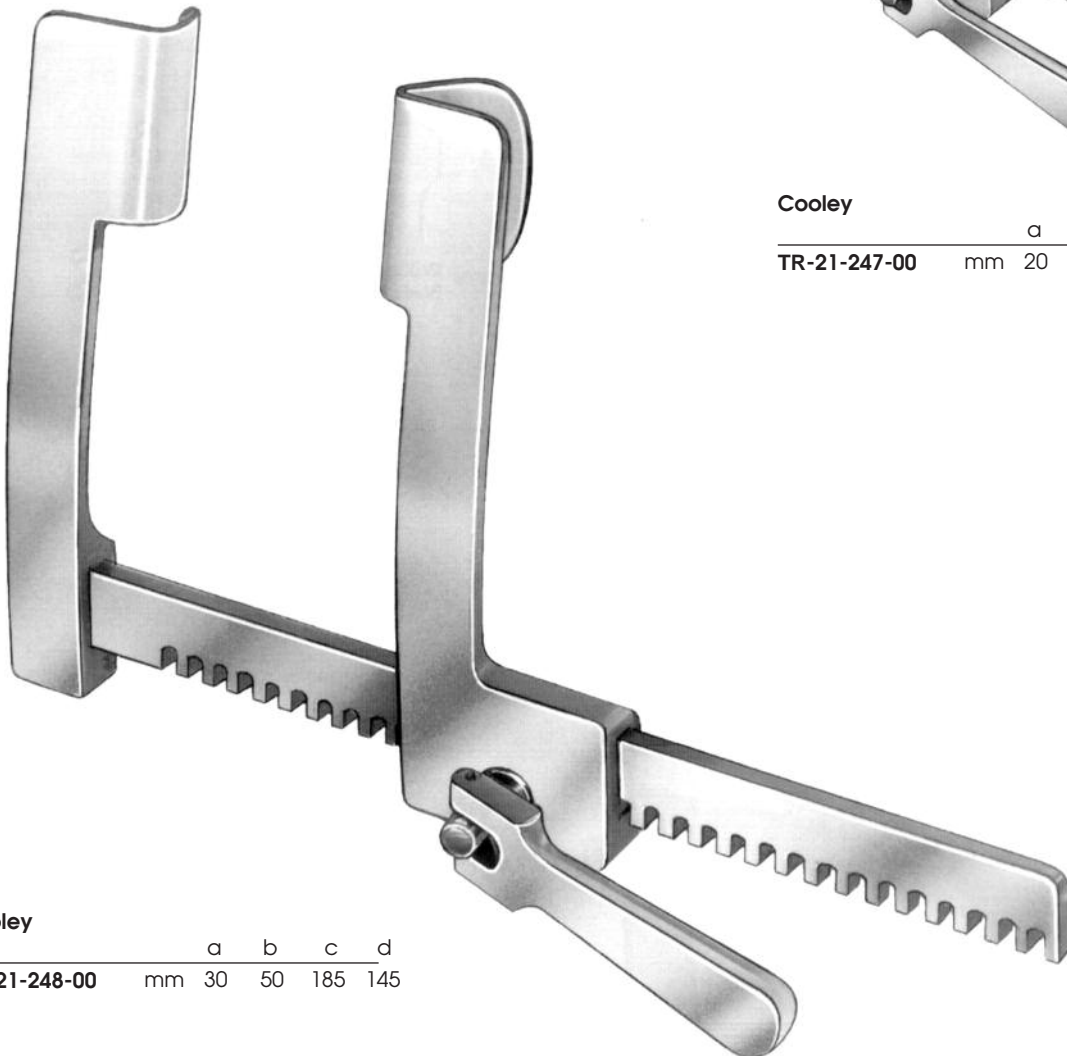

Cooley

	a	b	c	d
TR-21-248-00	mm 30	50	185	145

Measurement of blades and spreader

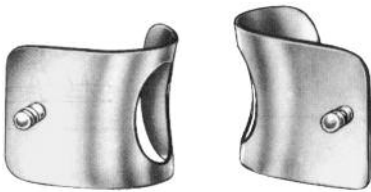
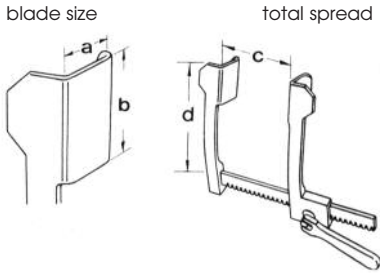

Mercedes
pair of blades

		a	b
TR-21-251-02	mm	45	68
TR-21-251-03	mm	78	78

Rip Spreader

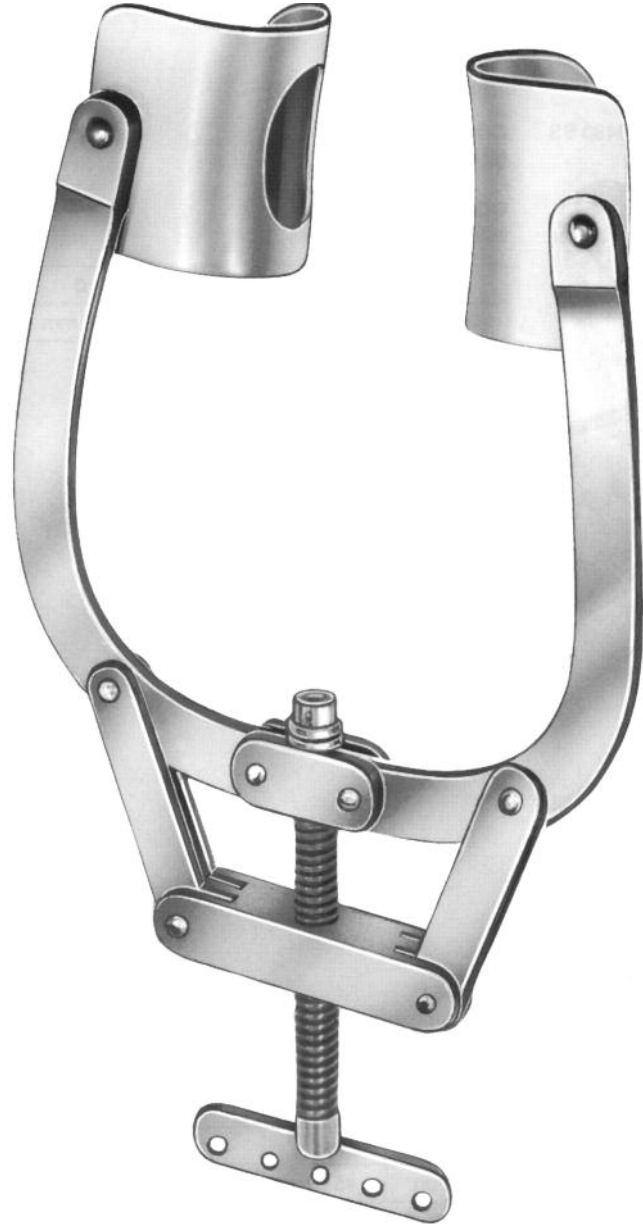

Mercedes

		c	d
TR-21-251-00	mm	285	185

complete
consisting of:

- TR-21-251-01 Rippensperrer, allein
- TR-21-251-02 pair
- 2WS-1-251-03 pair



Sellers
20,0 cm **TR-21-261-19**

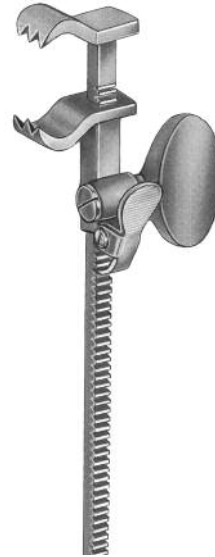

Baby-Bailey
15,0 cm **TR-21-262-14**

short claws



Bailey
16,5 cm **TR-21-263-16**

lang claws



Bailey-Gibbon
16,5 cm **TR-21-264-16**

Lung Spatula



Allison

40 mm/25,5 cm **TR-21-301-25**
50 mm/30,0 cm **TR-21-301-30**
54 mm/32,0 cm **TR-21-301-32**

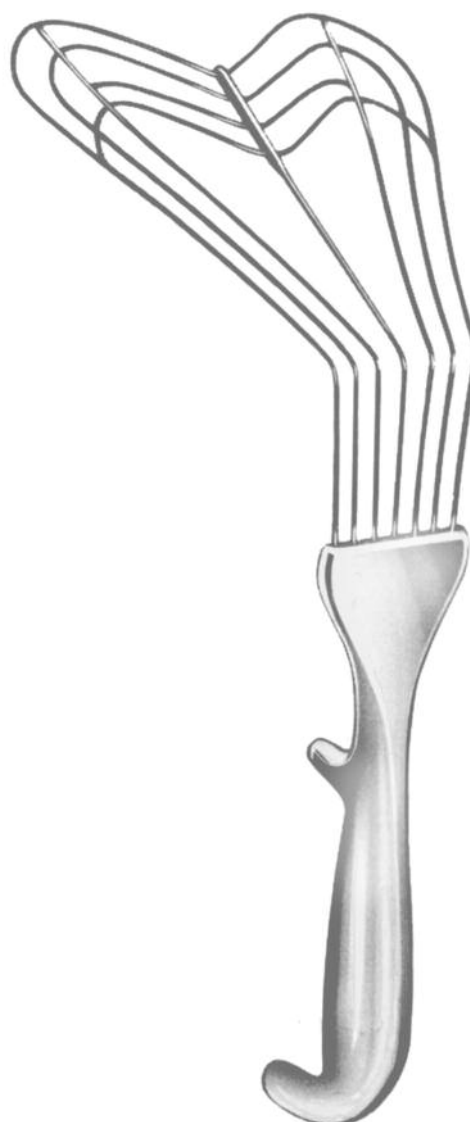

Spatula

135 mm/30,0 cm **TR-21-302-30**



Lovelace
20,5 cm **TR-21-310-20**

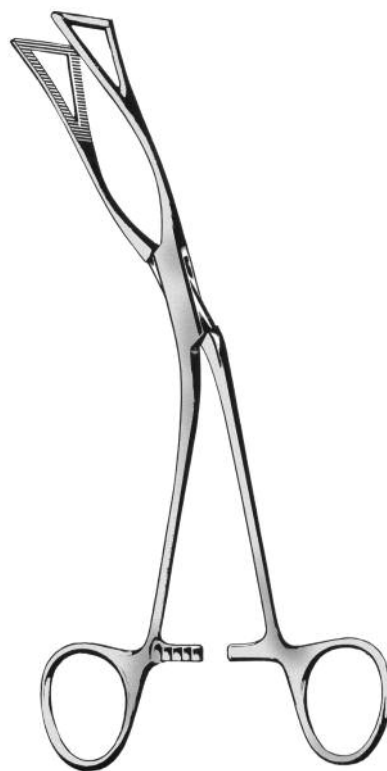

Lovelace
20,5 cm **TR-21-311-20**

Lung Instruments



Price-Thomas
22,0 cm TR-21-313-22



teeth left
22,0 cm TR-21-315-22



teeth right
22,0 cm TR-21-317-22



Semb



25,0 cm TR-21-325-23

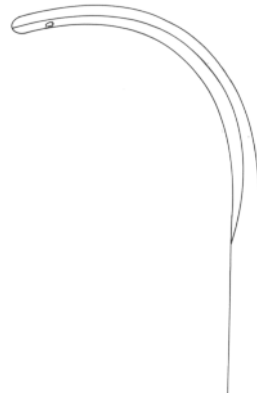

25,0 cm TR-21-327-23

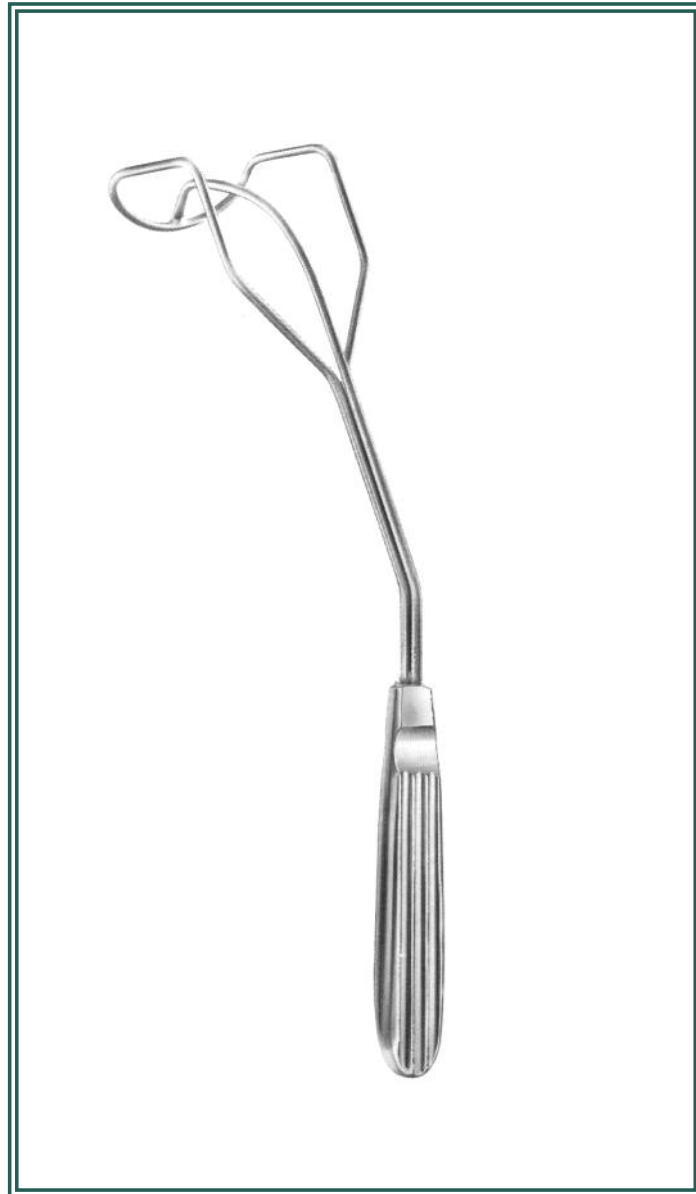

13

Cardiovascular

Varicose Vein Probe Set

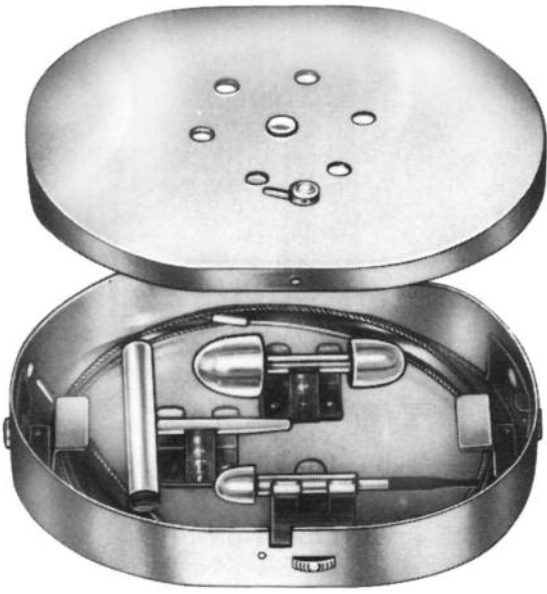

Nabatoff
complete
135x100x25 mm **TR-23-010-00**
Metal case , only **TR-23-010-09**

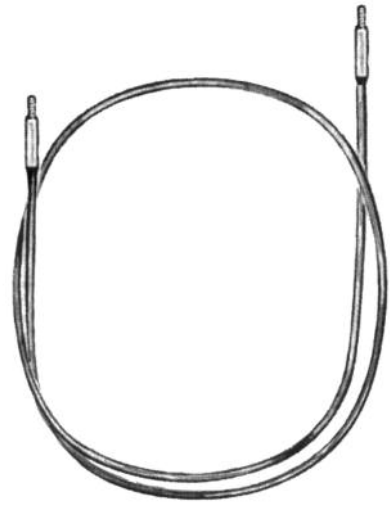

Zugseil
Traction Cable
90 cm **TR-23-010-01**

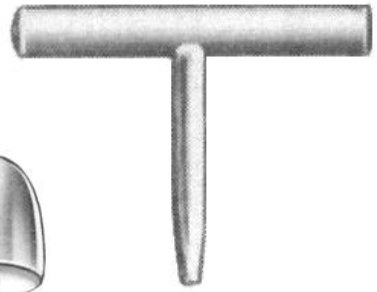

PlasticProbeTip **MetalProbeTip** \varnothing 6,0 mm \varnothing 9,0 mm \varnothing 12,0 mm \varnothing 15,0 mm Handle
TR-23-010-0 **TR-3-010-03** **TR-23-010-04** **TR-23-010-05** **TR-23-010-06** **TR-23-010-07** **TR-23-010-08**



TR-23-011-00, 11,0 cm

50,0 cm



Vollmar

TR-23-013-00

Set Ø 2,0 mm - 14,0 mm



TR-23-013-02 Ø 2,0 mm



TR-23-013-03 Ø 3,0 mm



TR-23-013-04 Ø 4,0 mm



TR-23-013-06 Ø 6,0 mm



TR-23-013-07 Ø 7,0 mm



TR-23-013-08 Ø 8,5 mm



TR-23-013-10 Ø 10 mm

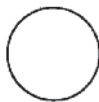

TR-23-013-12 Ø 12 mm

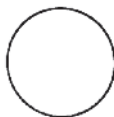

TR-23-013-14 Ø 14 mm

50,0 cm



Vollmar

TR-23-014-00

Set 2,0 mm - 14,0 mm



TR-23-014-02 2,5x2 mm



TR-23-014-03 3,6x3 mm



TR-23-014-04 5,2x4 mm



TR-23-014-05 6,5x5 mm



TR-23-014-06 7,8x6 mm



TR-23-014-07 9x7 mm



TR-23-014-08 10,5x8 mm



TR-23-014-09 11,5x9 mm



TR-23-014-10 13x10 mm



TR-23-014-12 16x12 mm



TR-23-014-14 19x14 mm

Vascular Dilators

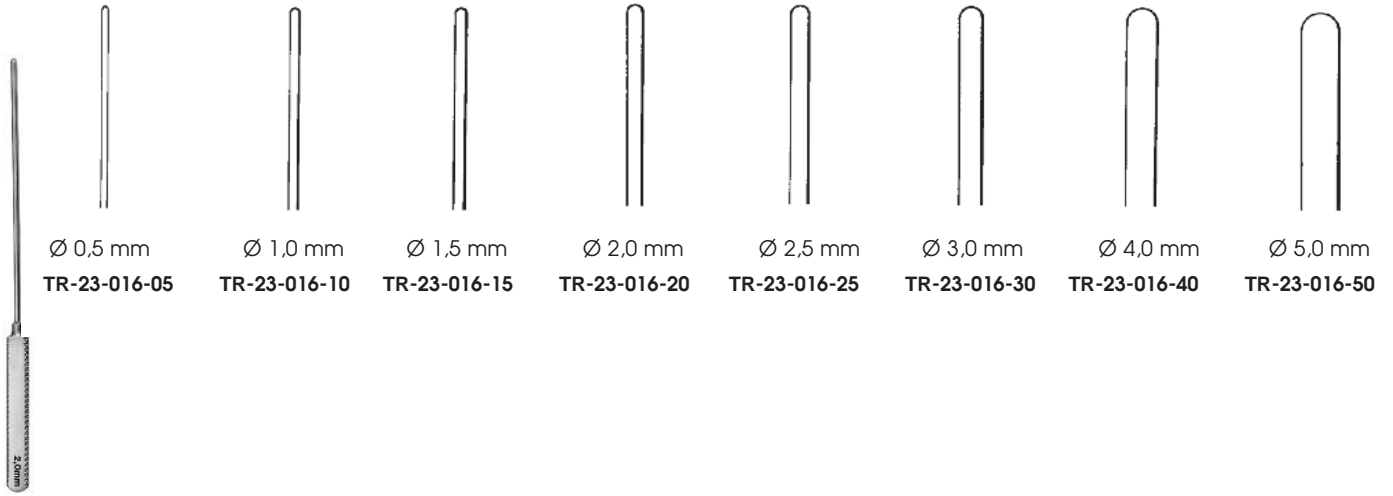

Cooley, 13,0 cm

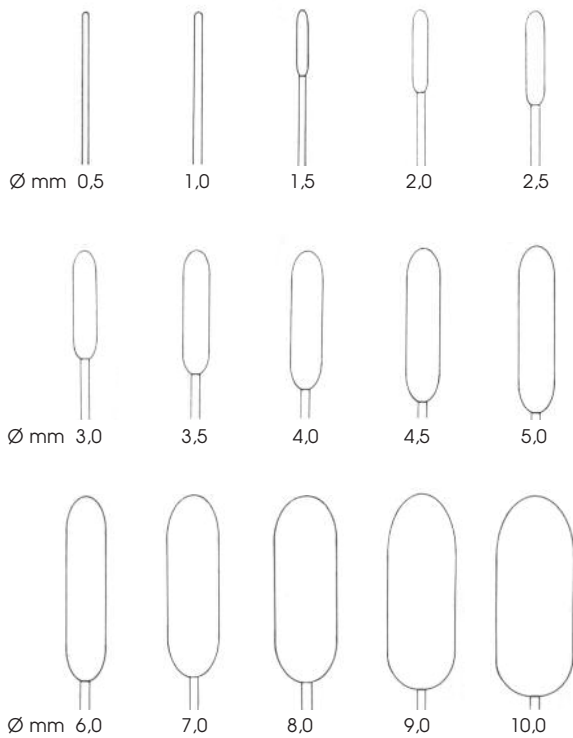

19,0 cm	35,0 cm	Ø mm
TR-23-018-05	TR-23-019-05	0,5
TR-23-018-10	TR-23-019-10	1,0
TR-23-018-15	TR-23-019-15	1,5
TR-23-018-20	TR-23-019-20	2,0
TR-23-018-25	TR-23-019-25	2,5
TR-23-018-30	TR-23-019-30	3,0
TR-23-018-35	TR-23-019-35	3,5
TR-23-018-40	TR-23-019-40	4,0
TR-23-018-45	TR-23-019-45	4,5
TR-23-018-50	TR-3-019-50	5,0
TR-23-018-60	TR-23-019-60	6,0
TR-23-018-70	TR-23-019-70	7,0
TR-23-018-80	TR-23-019-80	8,0
TR-23-018-90	TR-23-019-90	9,0
TR-23-018-99	TR-23-019-99	10,0



De Bakey

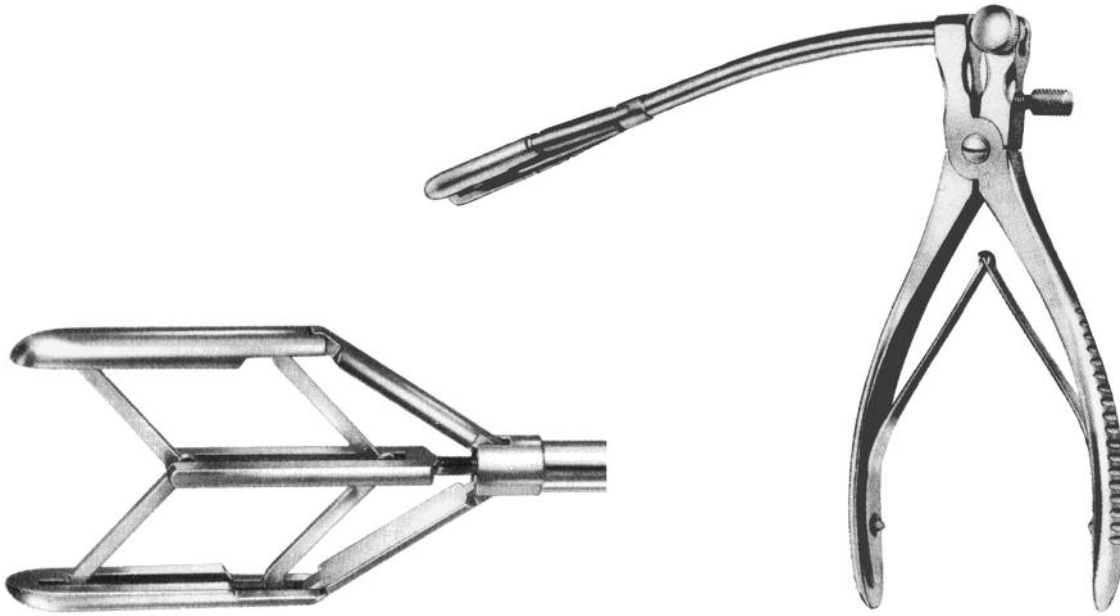

Blade opening 8 - 42 mm

Tubbs
TR-23-030-00

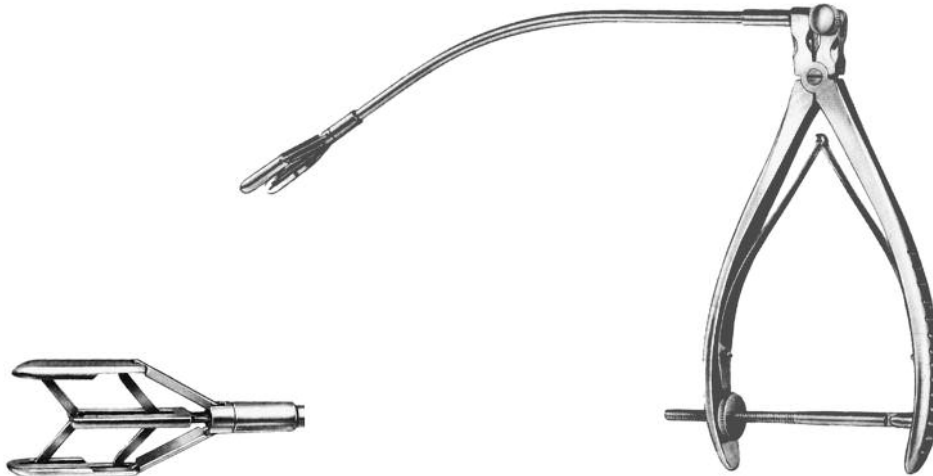

Blade opening 8 - 15 mm

Cooley
TR-23-032-00

Dura Dissectors

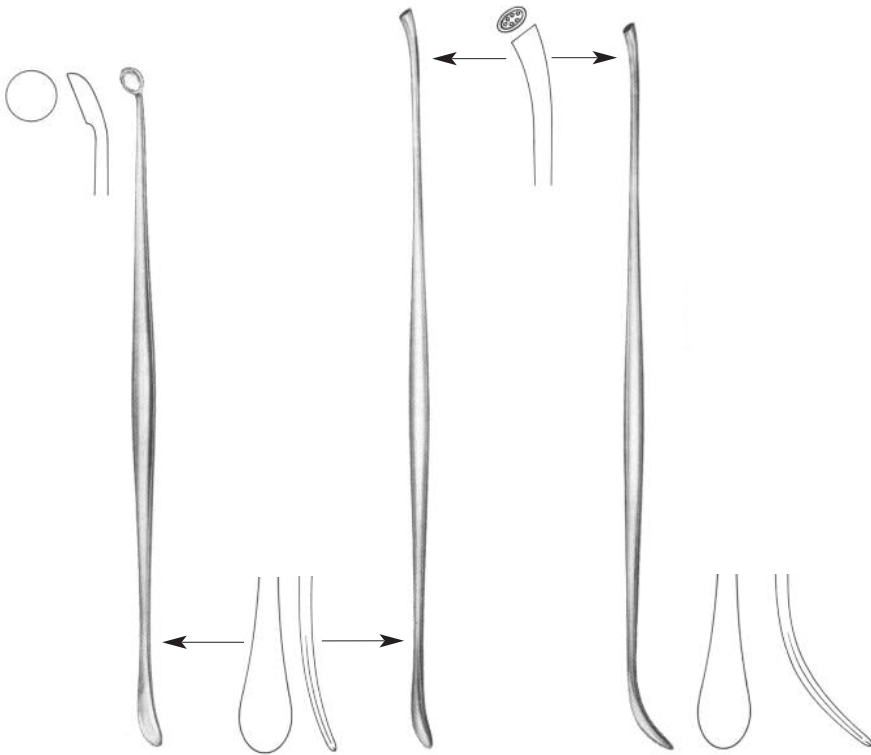

Penfield, Fig. 1
17,5 cm **TR-23-100-01**

Penfield, Fig. 2
19,5 cm **TR-23-100-02**

Penfield, Fig. 3
19,5 cm **TR-23-100-03**

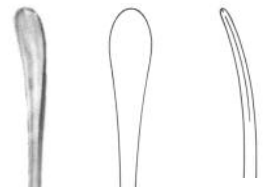

Penfield, Fig. 4
21,5 cm **TR-23-100-04**

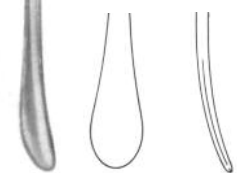

Penfield, Fig.5
29,0 cm **TR-23-100-05**



Halle
18,0 cm **TR-23-102-18**



23,0 cm **TR-23-104-23**



Freer
18,0 cm **TR-23-105-18**



18,5 cm **TR-23-107-18**
21,5 cm **TR-23-107-21**



Schmid



14,0 cm, 4 mm
TR-23-108-14



23,0 cm, 6 mm
TR-23-108-23

Dura Dissectors

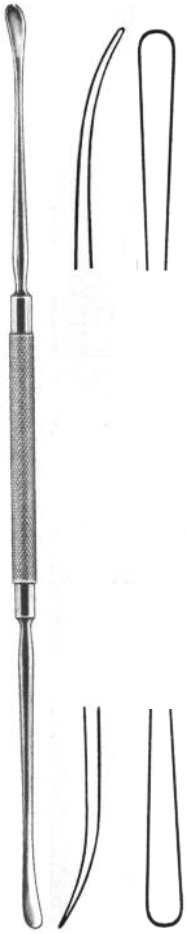

Davis
24,5 cm TR-23-109-24

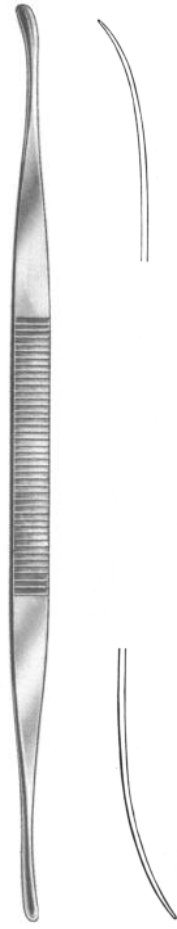

Tönnis

3/5 mm
TR-23-111-01

4/6 mm
TR-23-111-02



Robb
Fig. 1
2,5/5,0 mm
TR-23-113-01



Robb
Fig. 2
2,0/4,0 mm
TR-23-113-02



Robb
Fig. 3
1,5/3,0 mm
TR-23-113-03



Robb
Fig. 4
1,5/2,0 mm
TR-23-113-04

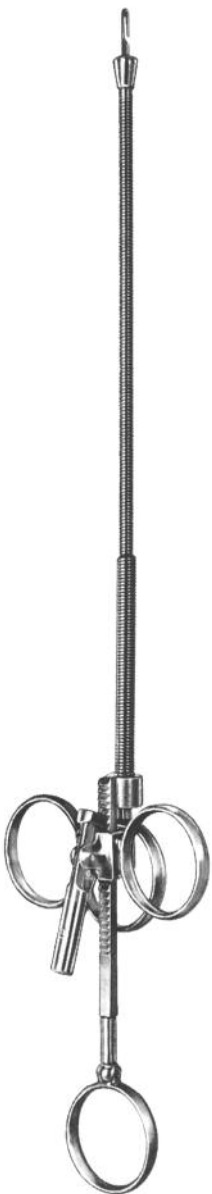

Rumel-Belmont, 32,0 cm

- Ø 3,2 mm **TR-23-130-32**
- Ø 4,0 mm **TR-23-130-40**
- Ø 6,4 mm **TR-23-130-64**



Fadenfänger, 26,0 cm



1,5 mm
TR-23-132-15



2,5 mm
TR-23-132-25



2,0 mm
TR-23-132-20



3,0 mm
TR-23-132-30



Blake

20,5 cm **TR-23-140-20**



Blake
20,5 cm **TR-23-141-20**

Atrium Retractors



Cooley
right
45x48 mm
24,5 cm **TR-23-200-24**



Cooley
right, serrated
45x48 mm
24,5 cm **TR-23-201-24**



Cooley
left
45x48 mm
25,5 cm **TR-23-202-25**

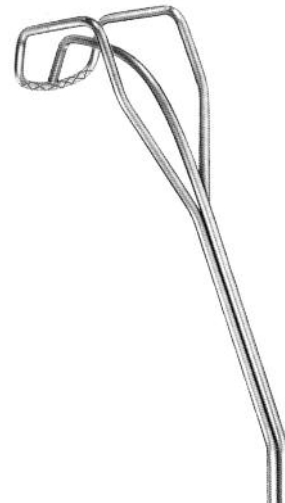

Cooley
right, serrated
24,0 cm 45x30 mm **TR-23-203-24**
24,0 cm 45x35 mm **TR-23-204-24**



Cooley

- 12,0 cm **TR-23-600-12**
- 18,0 cm **TR-23-600-18**



- 13,5 cm **TR-23-604-13**
- 15,5 cm **TR-23-606-15**
- 18,0 cm **TR-23-608-18**
- 20,0 cm **TR-23-610-20**



TR-23-611-21



Landolt
TR-23-613-25

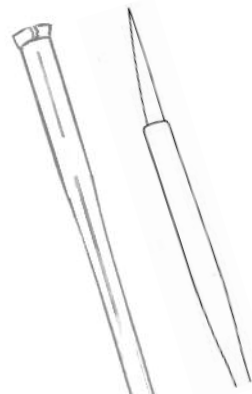

TR-23-615-21

Vessel Instruments

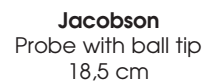
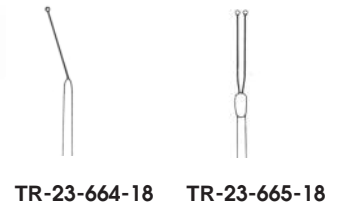
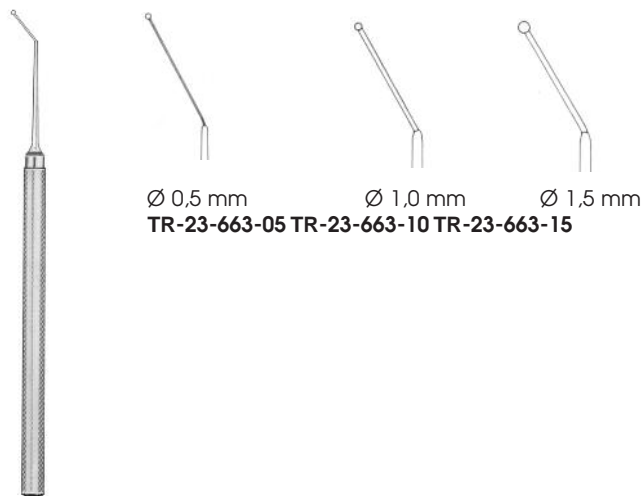
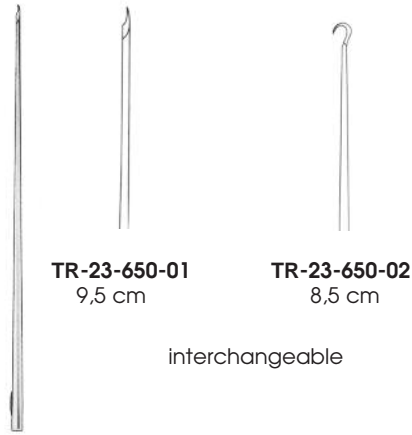
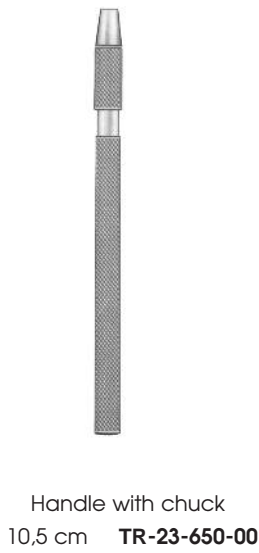

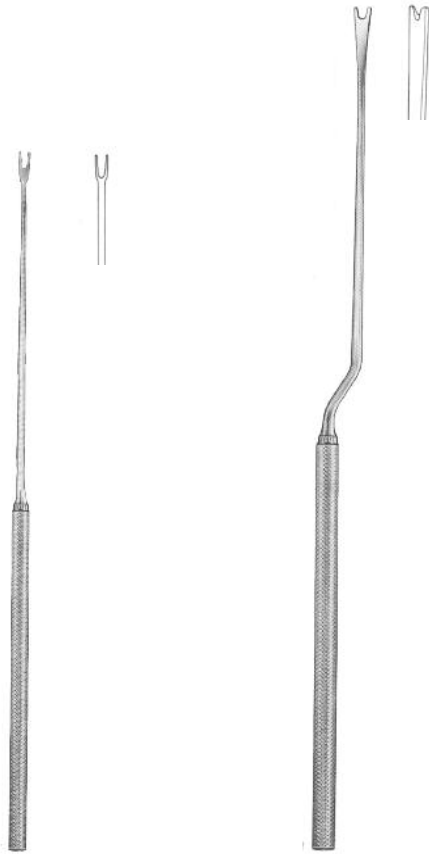

Jacobson
Suture Pusher
18,5 cm **TR-23-666-18**

Caspar
Suture Pusher
23,0 cm **TR-23-667-23**

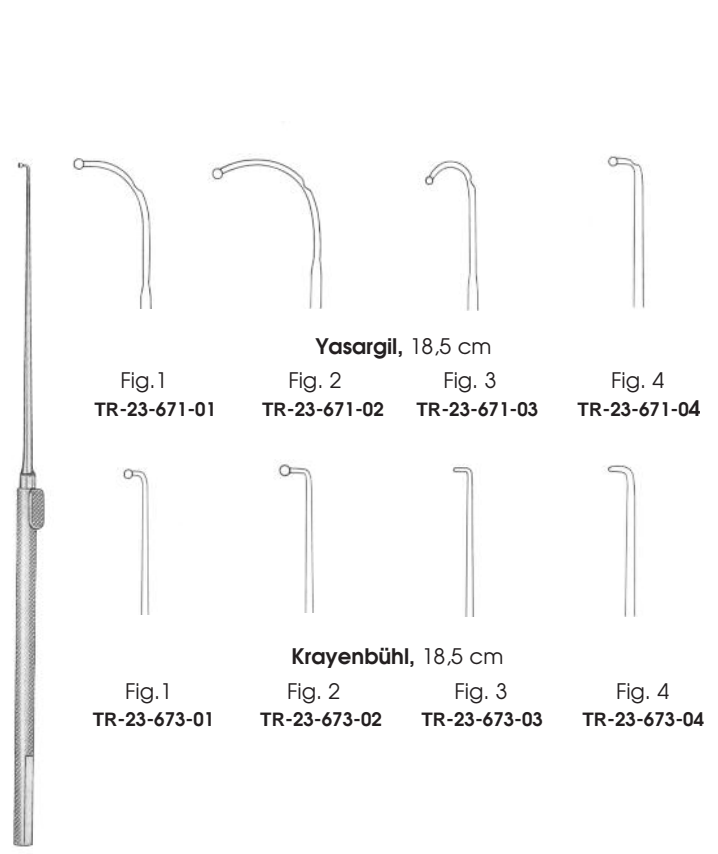

Yasargil, 18,5 cm
Fig. 1 **TR-23-671-01** Fig. 2 **TR-23-671-02** Fig. 3 **TR-23-671-03** Fig. 4 **TR-23-671-04**

Krayenbühl, 18,5 cm
Fig. 1 **TR-23-673-01** Fig. 2 **TR-23-673-02** Fig. 3 **TR-23-673-03** Fig. 4 **TR-23-673-04**

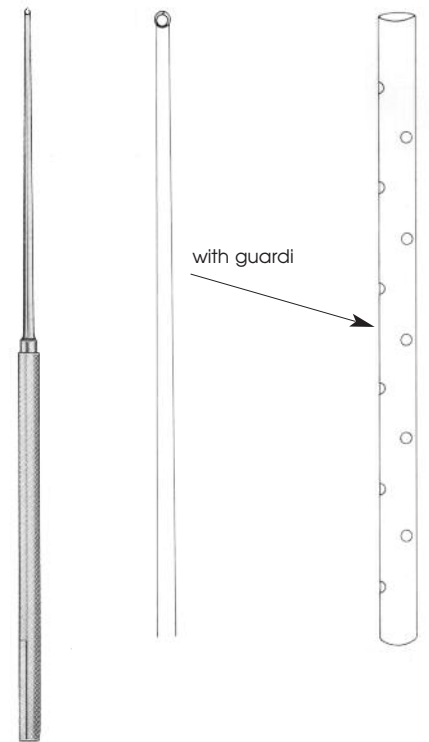

Tissue Picks
Ø 1,8 mm
18,5 cm **TR-23-674-18**

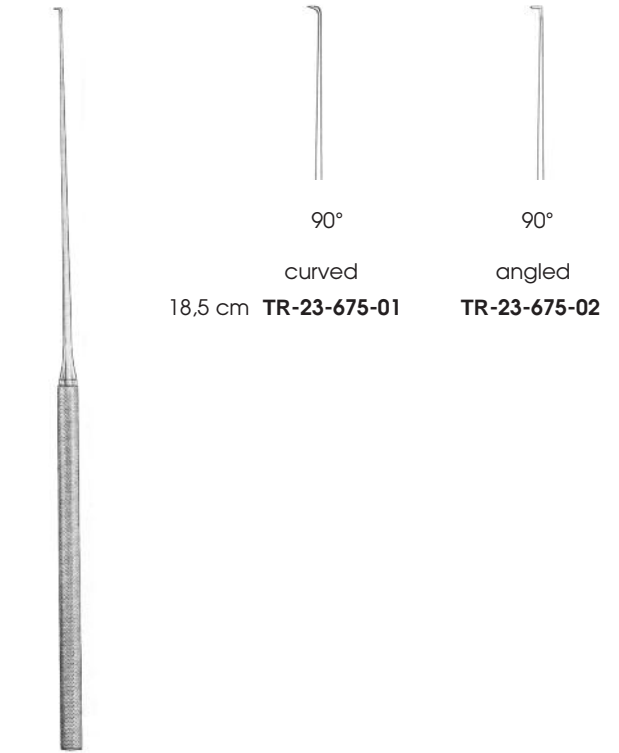

Sharp Hook

90° curved **TR-23-675-01**
90° angled **TR-23-675-02**



Micro Dissector
23,0 cm

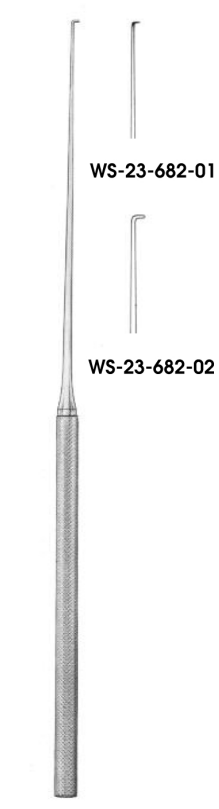

Micro Hook
23,0 cm

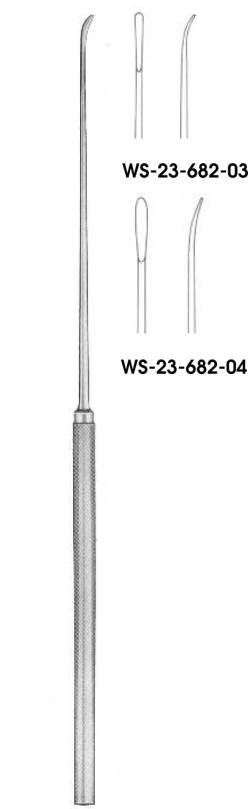

Micro Dissector
23,0 cm



Micro Scoop
23,0 cm

Vessel Instruments

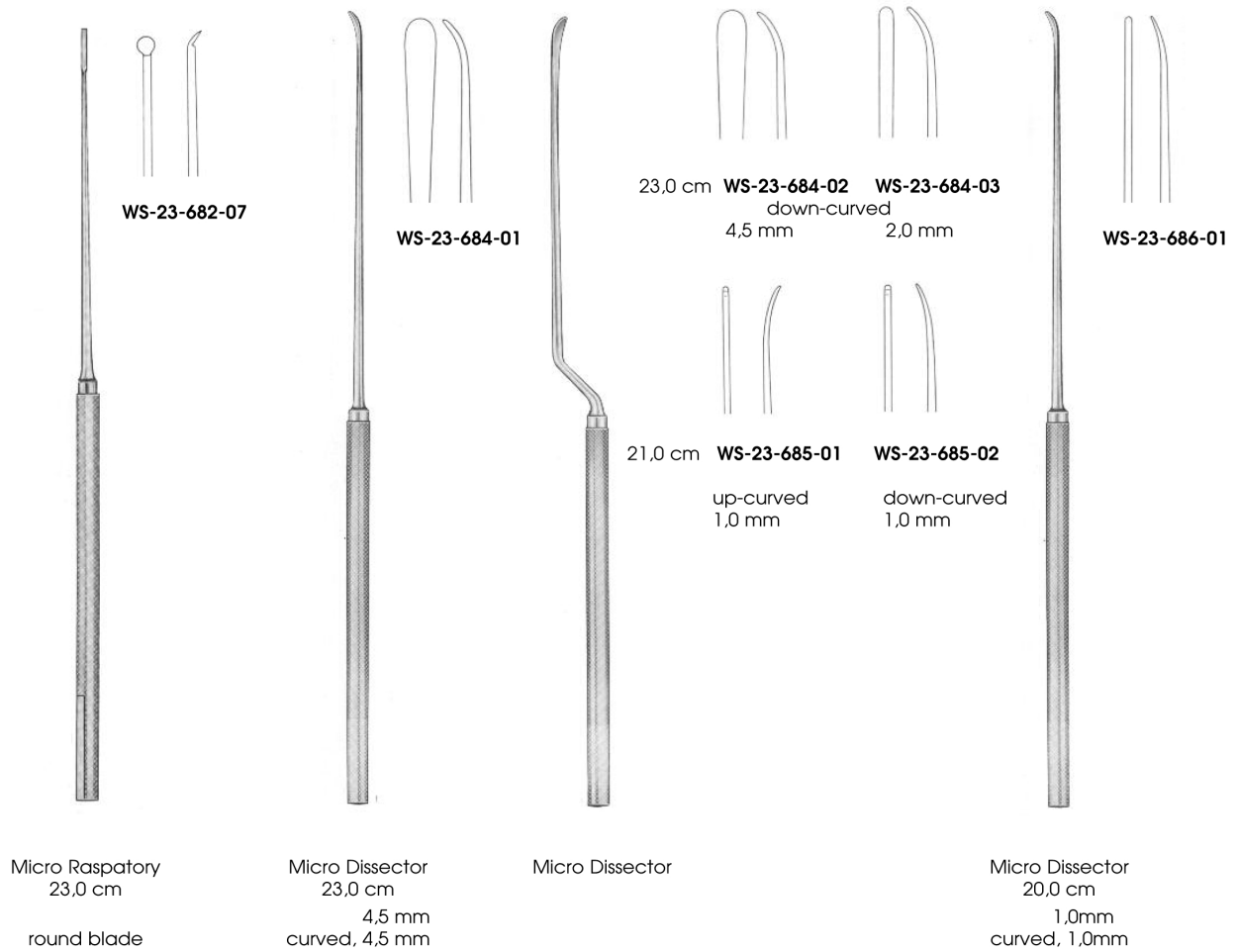

Micro Raspatory
23,0 cm
round blade

Micro Dissector
23,0 cm
4,5 mm
curved, 4,5 mm

Micro Dissector

Micro Dissector
20,0 cm
1,0mm
curved, 1,0mm

Vessel Instruments



Exploration- and
Coagulation Hook
24,5 cm



Fig. 1
TR-23-688-01



Fig. 2
TR-23-688-02



Fig. 3
TR-23-688-03



Fig. 4
TR-23-688-04

probe-end, insulated



Micro Raspatory
18,5 cm



angled
TR-23-692-01



angled
TR-23-692-02

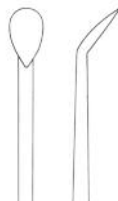

angled
TR-23-692-03

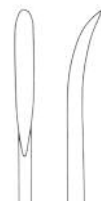

curved
TR-23-692-04



curved
TR-23-692-05



Micro Raspatory
18,5 cm



curved
TR-23-693-01

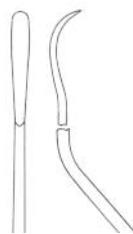

curved
TR-23-693-02

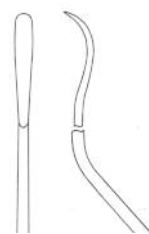

up-curved
TR-23-693-03



Micro Scoop
18,5 cm **TR-23-693-04**



1,0 mm

20,0 cm **TR-23-694-10**
23,0 cm **TR-23-695-10**



1,5 mm

TR-23-694-15
TR-23-695-15



2,0 mm

TR-23-694-20
TR-23-695-20



2,5 mm

TR-23-694-25
TR-23-695-25



3,0 mm

20,0 cm **TR-23-694-30**
23,0 cm **TR-23-695-30**



3,5 mm

TR-23-694-35
TR-23-695-35



4,0 mm

TR-23-694-40
TR-23-695-40



5,0 mm

TR-23-694-50
TR-23-695-50

Tumor Knife



1,5 mm

20,0 cm **TR-23-696-15**
23,0 cm **TR-23-697-15**



3,0 mm

TR-23-696-30
TR-23-697-30



4,5 mm

TR-23-696-45
TR-23-697-45



6,0 mm

TR-23-696-60
TR-23-697-60



1,8 mm

23,0 cm **TR-23-698-18**



2,5 mm

TR-23-698-25



Tumor Knife

Vessel Instruments



Micro Vessel Knife
18,5 cm **TR-23-699-01**



up-curved
TR-23-699-02



down-curved
TR-23-699-03



up-curved
TR-23-699-04



down-curved
TR-23-699-05



down-curved
TR-23-699-06



up-curved
TR-23-699-07



down-curved
TR-23-699-08



up-curved
TR-23-699-09



Micro Vessel Knife
18,5 cm



Micro Vessel Knife
18,5 cm **TR-23-699-10**

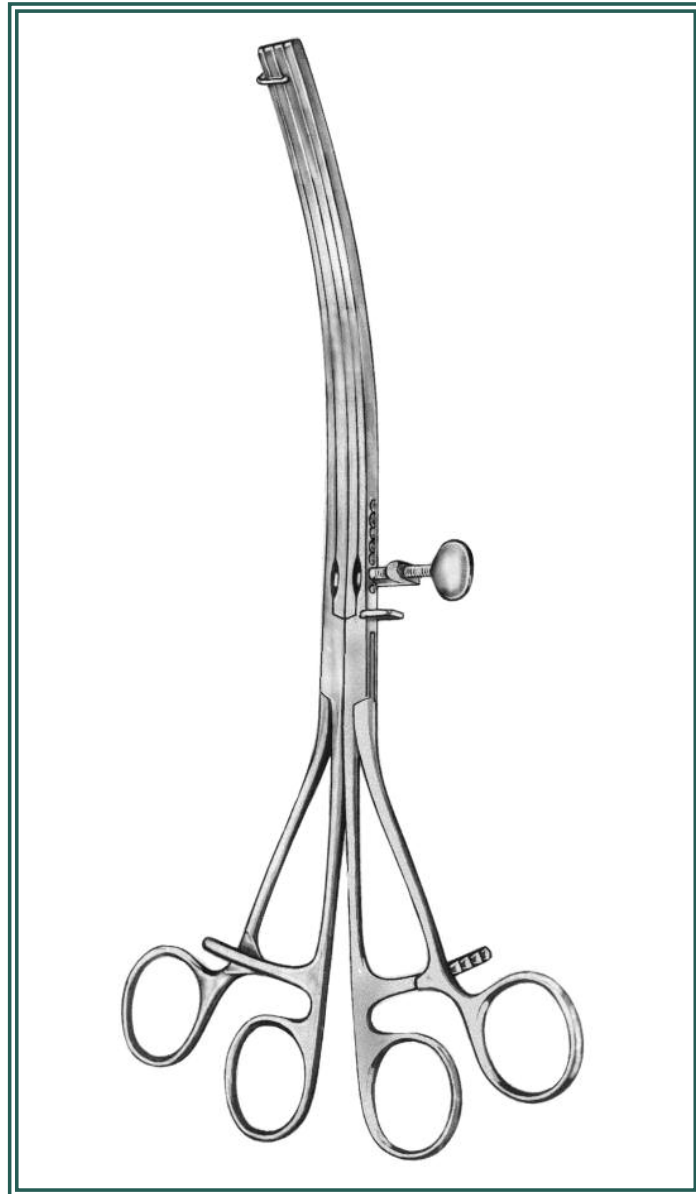

14

Stomach Intestinal Rectum

Intestinal Clamps

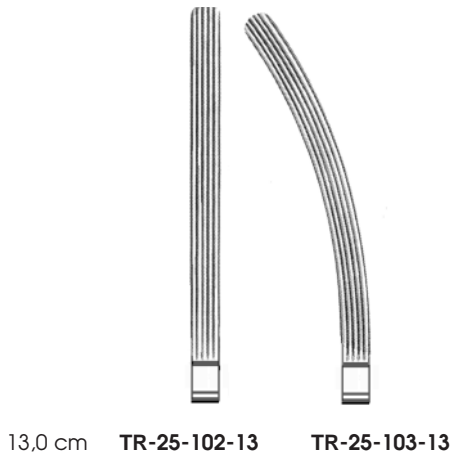

Baby-Kocher

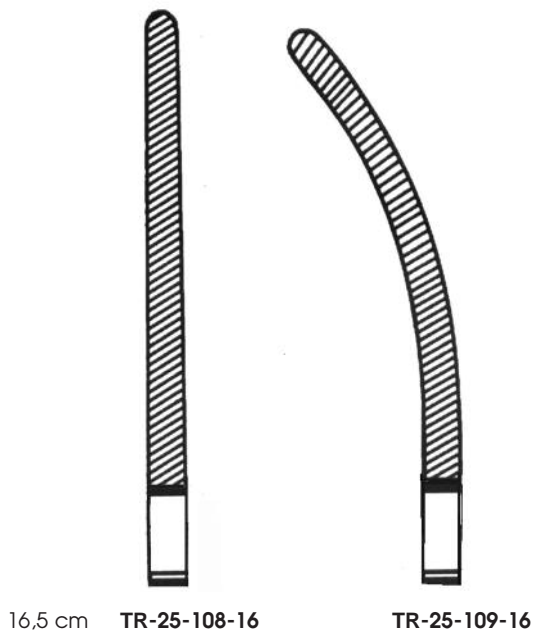
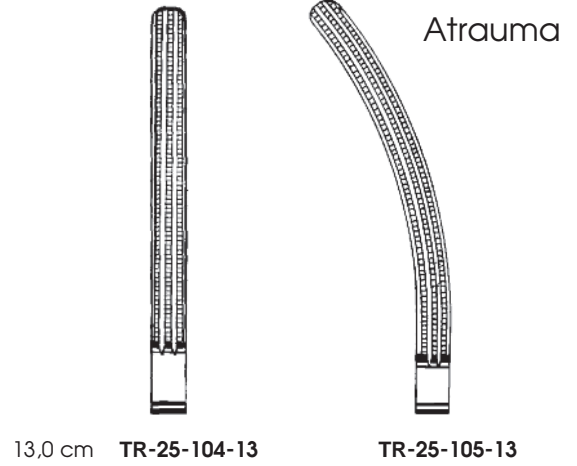

Doyen

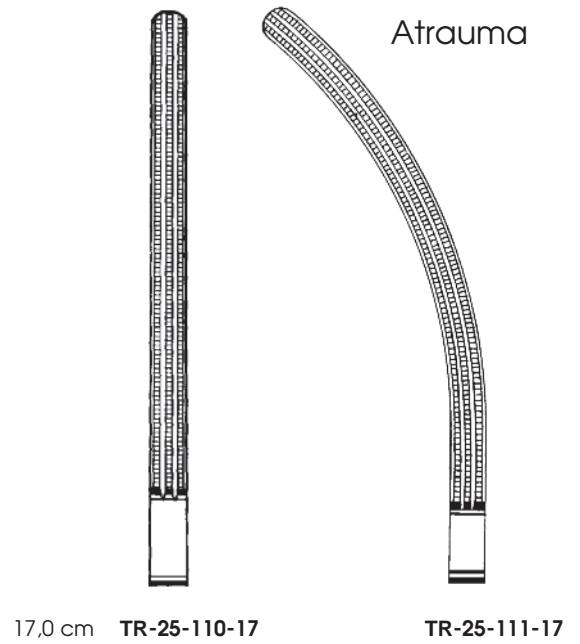



TR-25-114-20

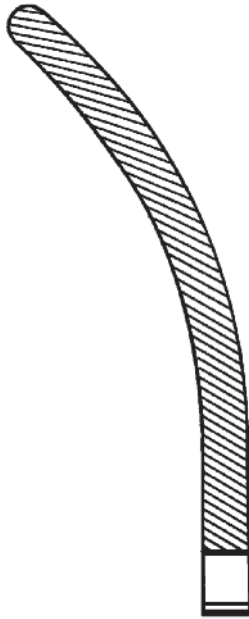

TR-25-115-20



Hartmann, 20 cm



TR-25-116-20

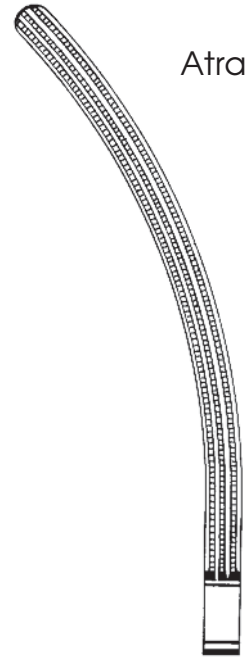

Atrauma

TR-25-117-20



21,0 cm TR-25-120-21
23,0 cm TR-25-120-23



TR-25-121-21
TR-25-121-23



Kocher

Intestinal Clamps



TR-25-126-23

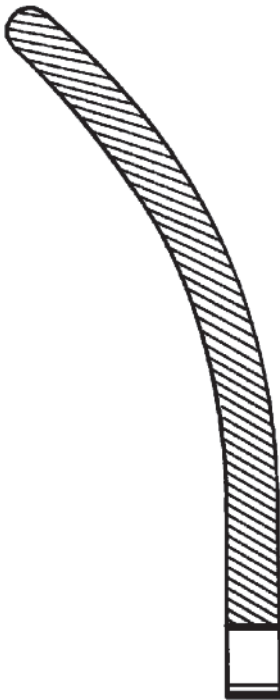

TR-25-127-23



Doyen, 23,0 cm



TR-25-128-23

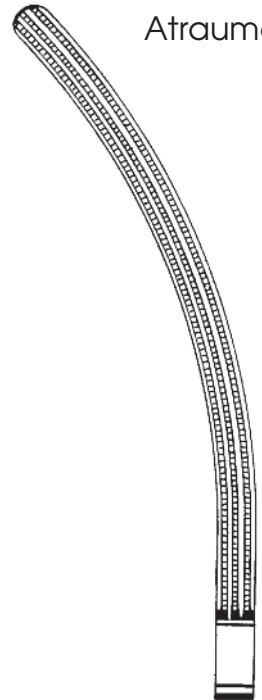

TR-25-129-23

Atrauma



Kocher

Intestinal Clamps

Atrauma



Kocher



22,0 cm
TR-25-134-22



25,0 cm
TR-25-134-25

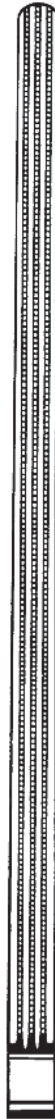

28,0 cm
TR-25-134-28

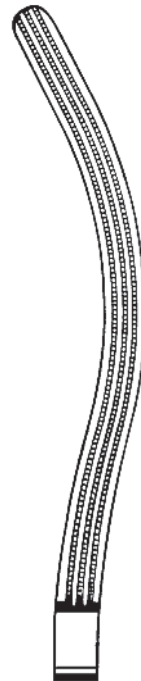

22,0 cm
TR-25-135-22

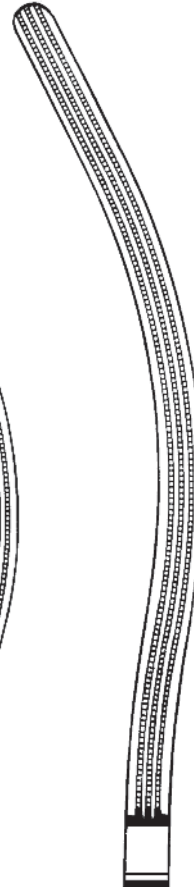

25,0 cm
TR-25-135-25

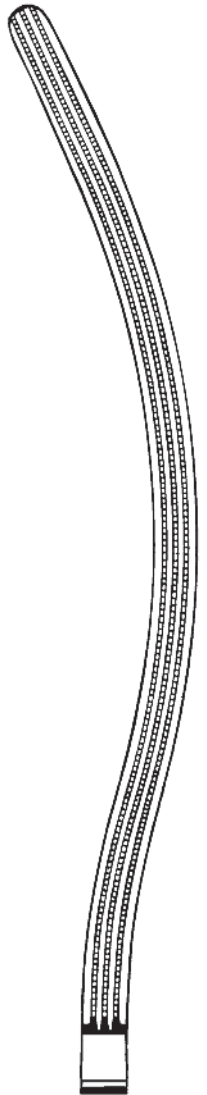

28,0 cm
TR-25-135-28

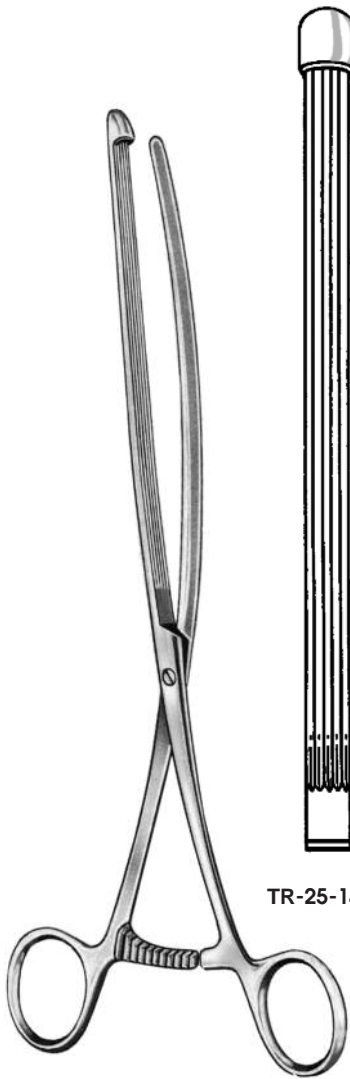

Nussbaum, 25,0 cm



TR-25-140-25

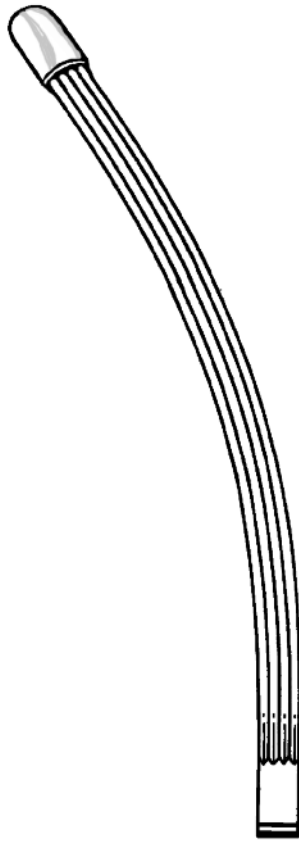

TR-25-141-25



Mayo-Robson, 25,0 cm



TR-25-144-25

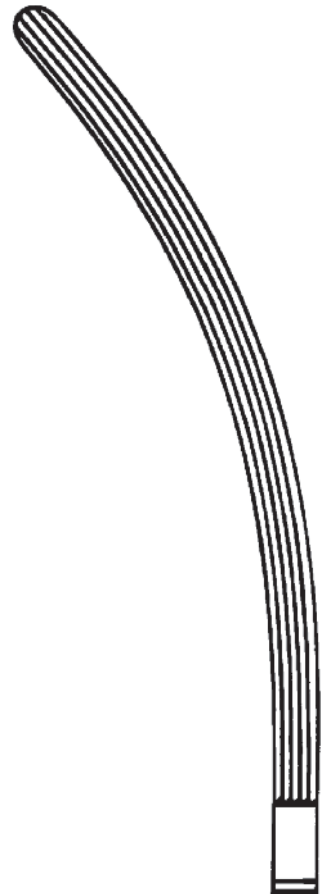

TR-25-145-25

Atrauma

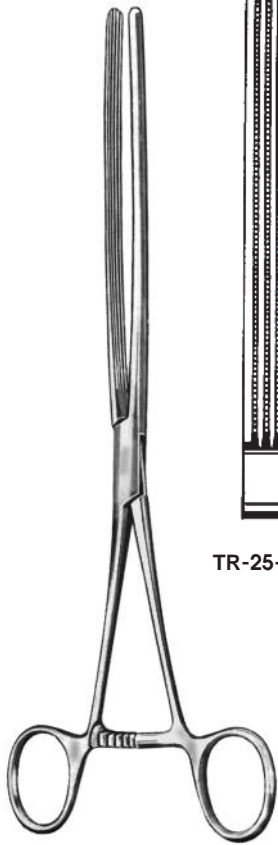

Mayo-Robson, 25,0 cm



TR-25-146-25

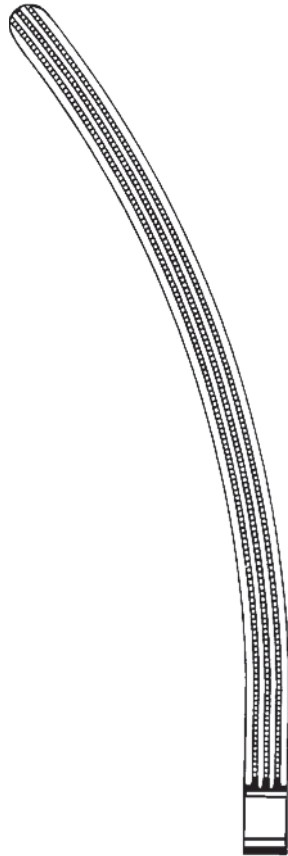

TR-25-147-25

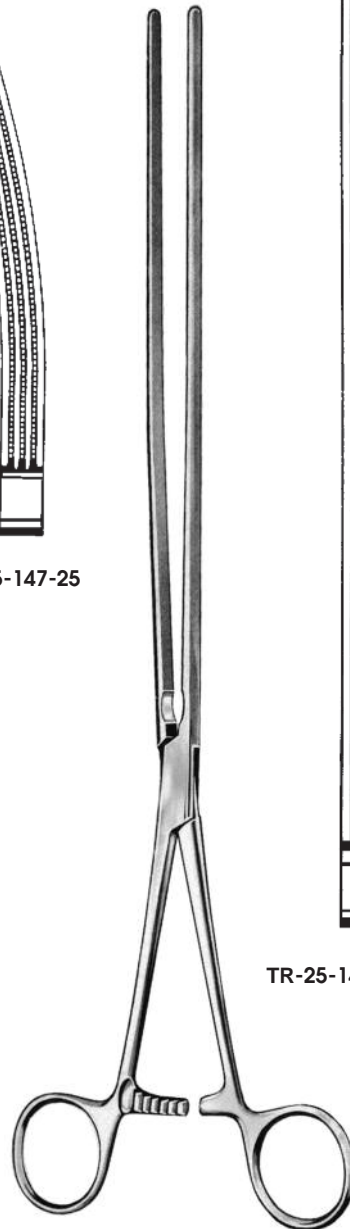

Scudder, 33,0 cm



TR-25-148-33

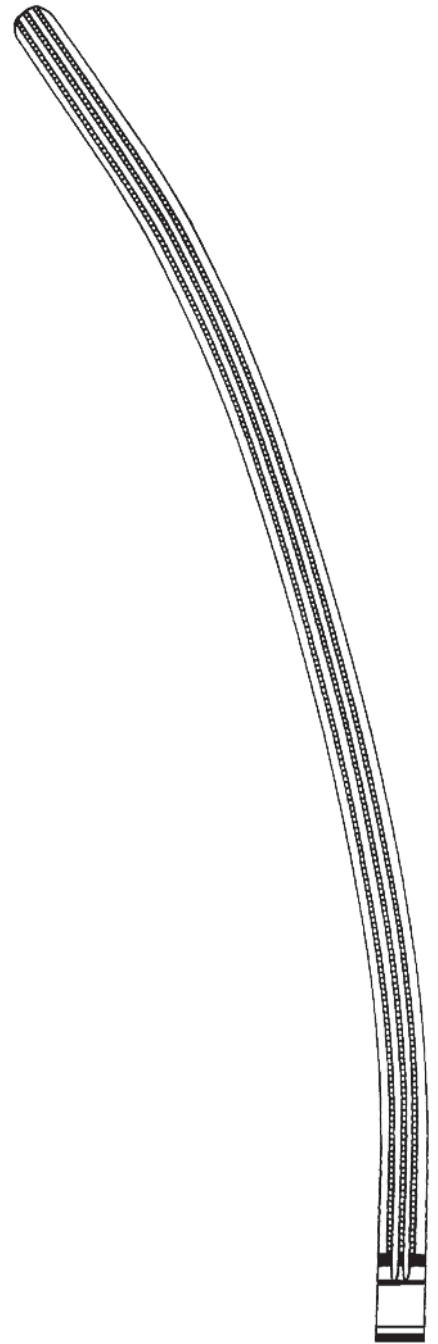

TR-25-149-33

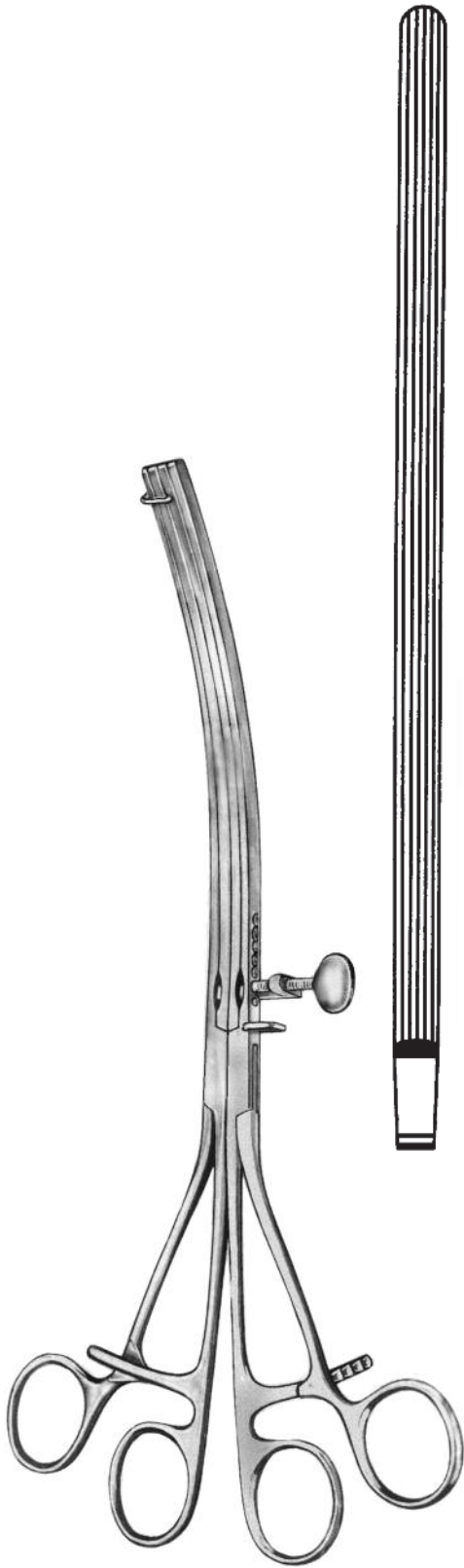

Lane, 30,0 cm

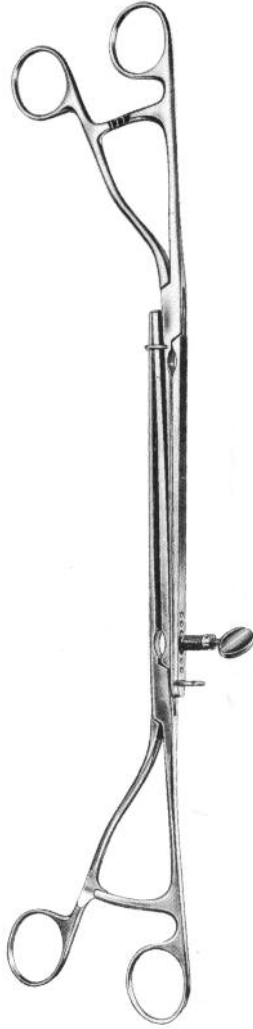

TR-25-160-30

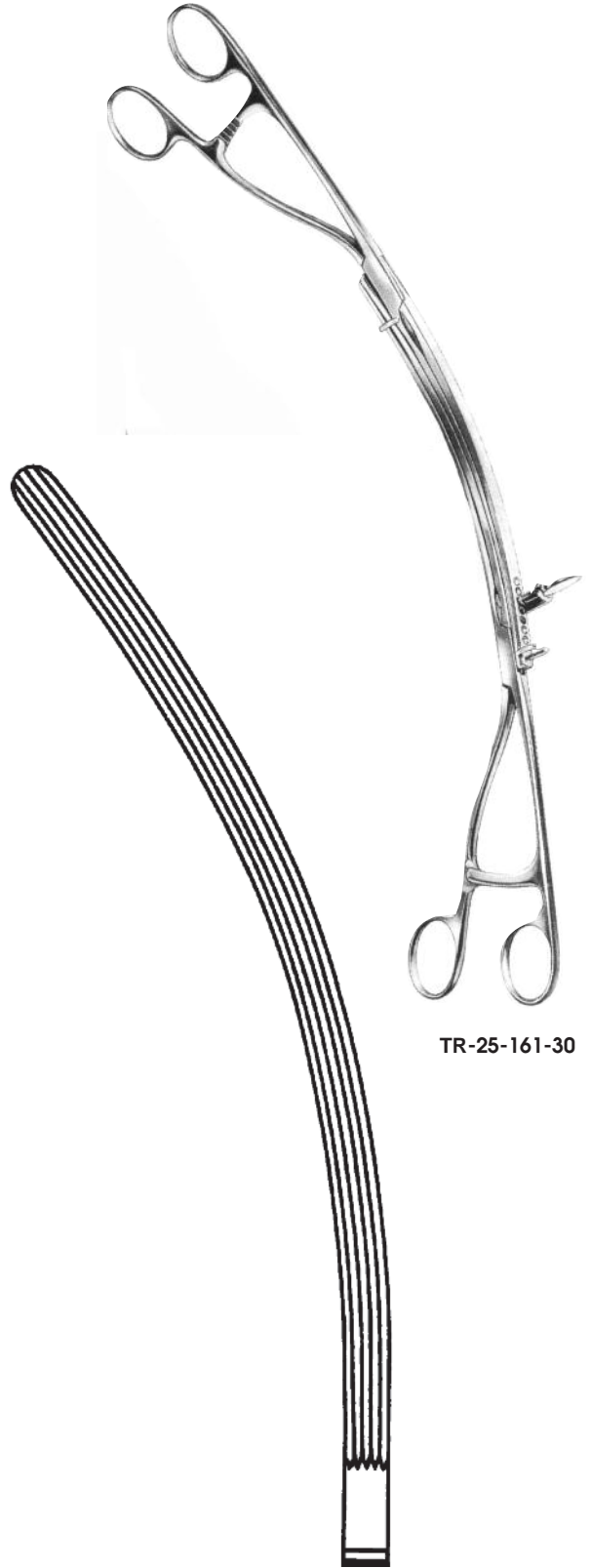

TR-25-161-30

Intestinal and Stomach Clamps



Payr

for Children
18,0 cm **TR-25-167-18**



Payr

20,0 cm
TR-25-167-20

27,0 cm
TR-25-167-27

31,0 cm
TR-25-167-31

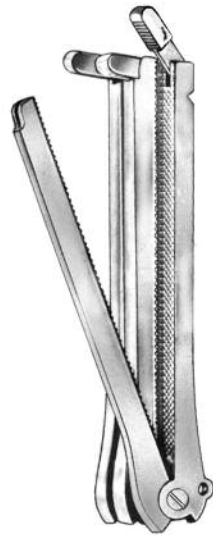

Set of 3 clamps



TR-25-170-07
7,0 cm



TR-25-170-10
10,0 cm



TR-25-170-12
12,0 cm

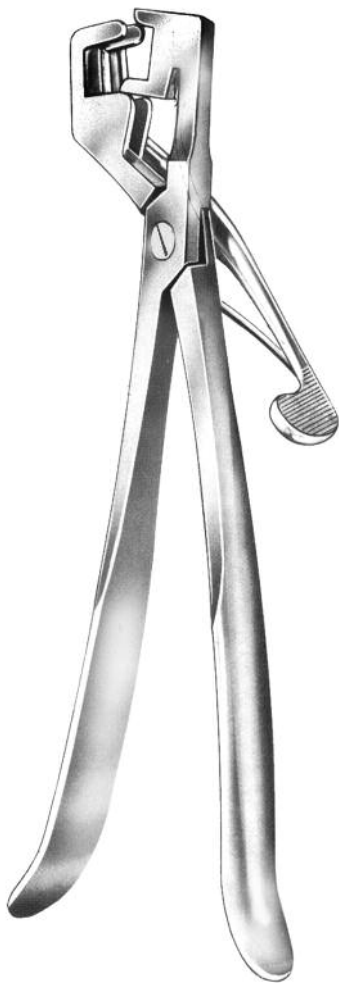

De Martel-Wolfson
26,0 cm TR-25-171-26

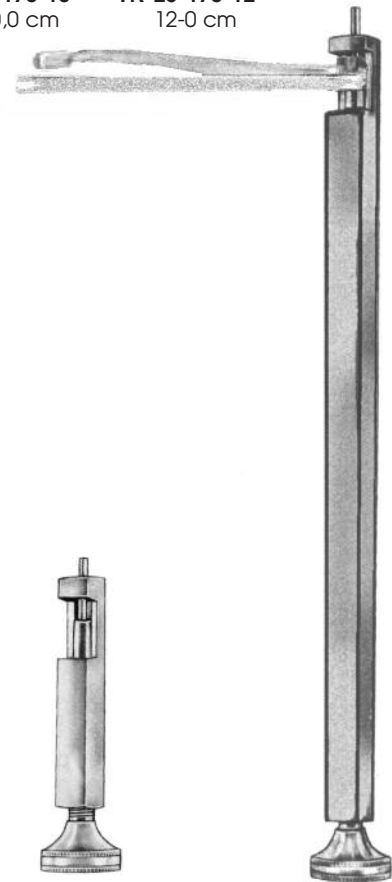

Clamp Holder
8,0 cm TR-25-176-08

Clamp Holder
23,0 cm TR-25-176-23

Sigmoid Anastomosis Clamps

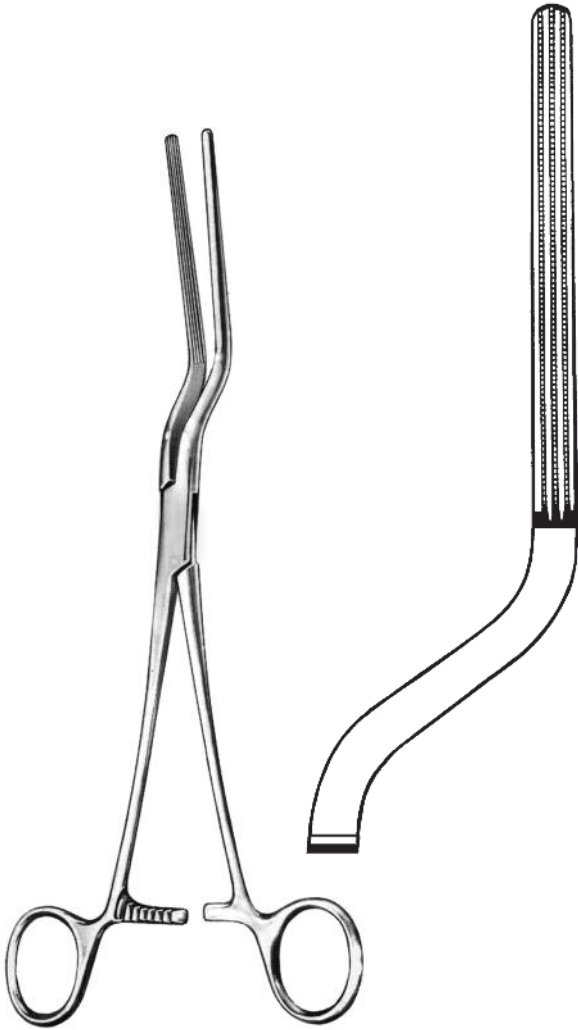

Brunner
24,0 cm TR-25-185-24

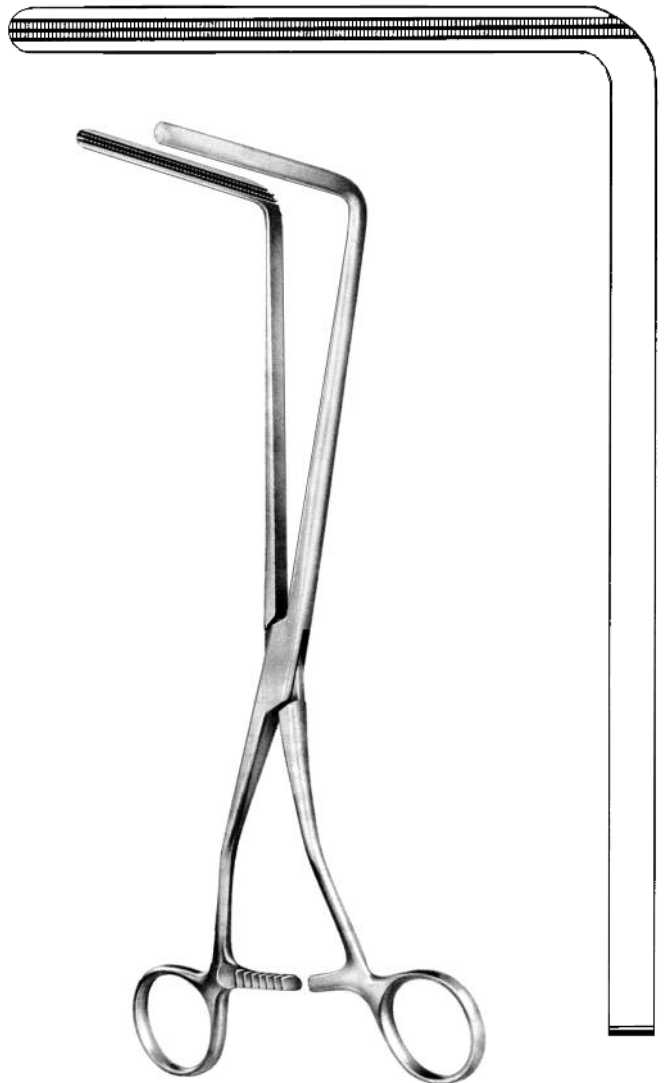

Resano
26,0 cm TR-25-194-26

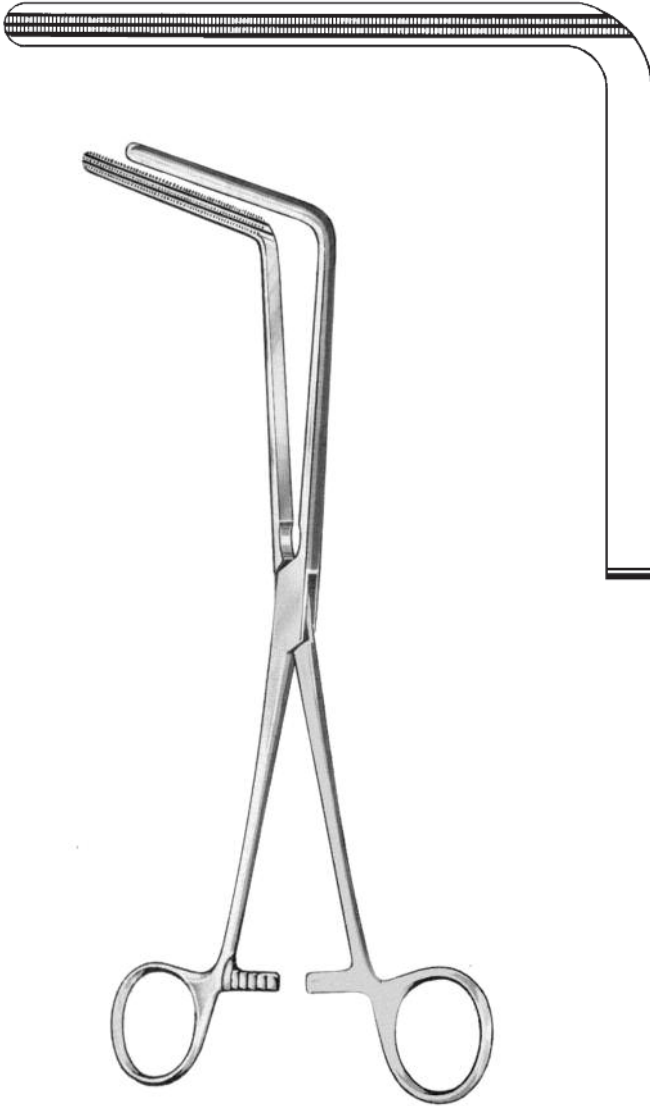

Fehland
24,0 cm TR-25-196-24

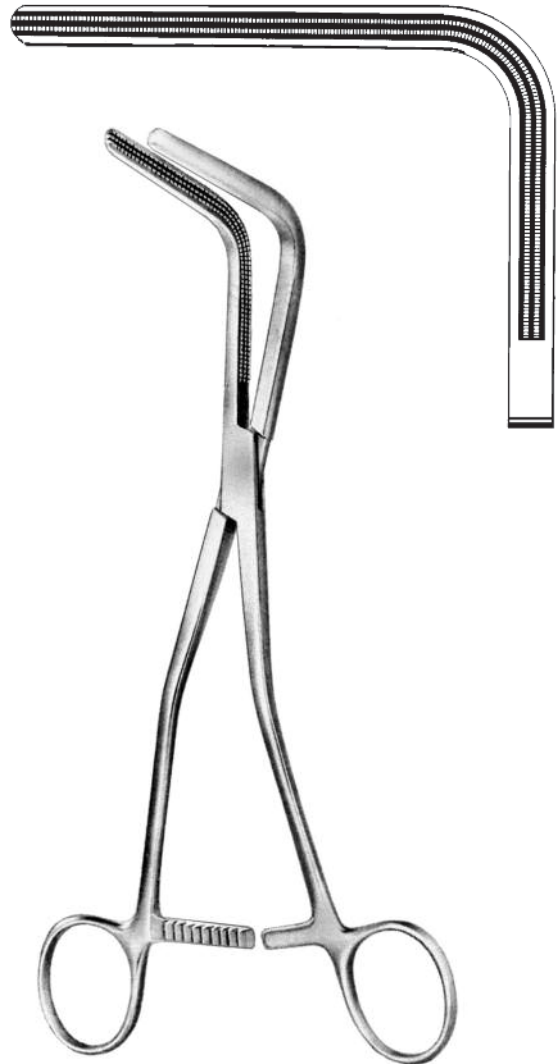

Veidenheimer
23,0 cm TR-25-197-23

Anastomosis Clamps



Hayes

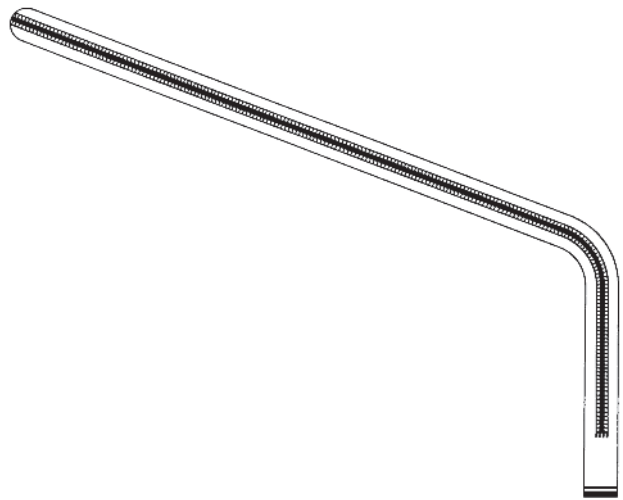

28,0 cm TR-25-198-28



27,0 cm TR-25-198-27



Sims
16,0 cm TR-25-300-16



Sims
16,0 cm TR-25-302-16

Cerny
22,5 cm TR-25-305-22



Pratt
20,5 cm TR-25-308-20

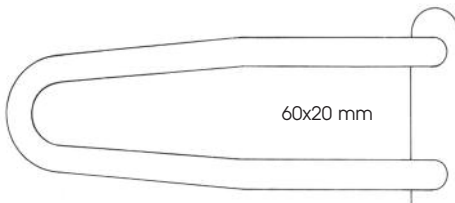
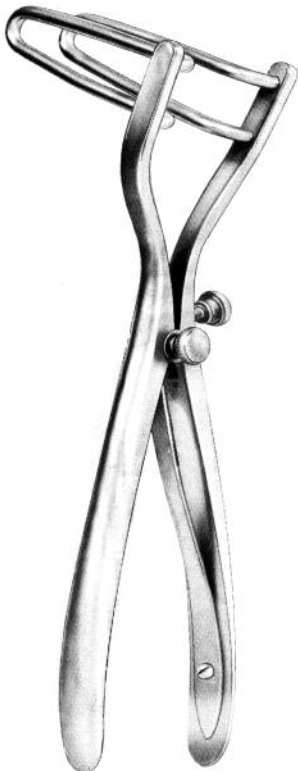

19,0 cm TR-25-310-19

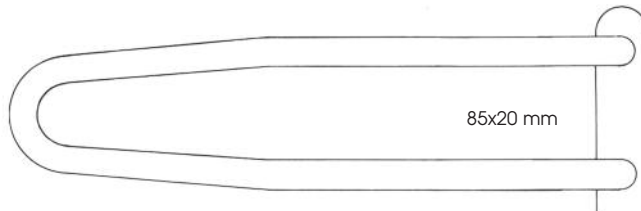

23,5 cm TR-25-310-23

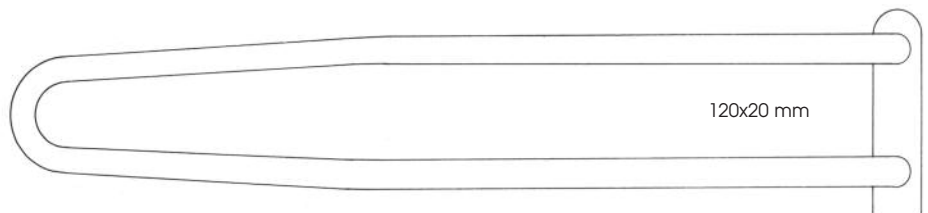

23,5 cm TR-25-310-24

Sims

Rectal Specula, Anuscope



Mathieu
21,5 cm TR-25-312-21



Ives-Fansler
14,5 cm, Ø 24 mm TR-25-316-24

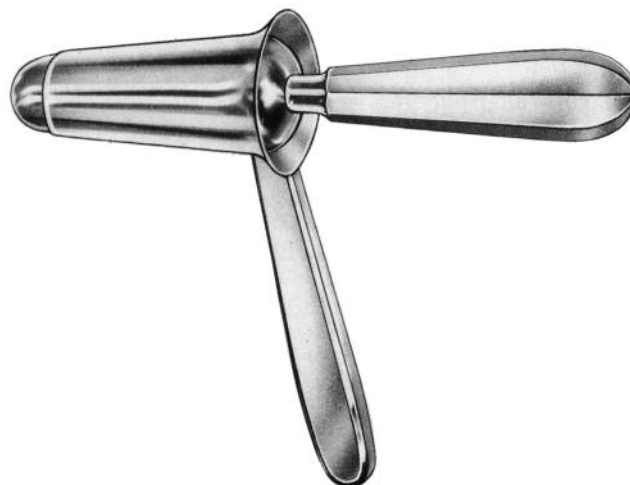

Kelly
16,0 cm, Ø 21 mm, 55 mm TR-25-318-21
16,0 cm, Ø 27 mm, 55 mm TR-25-318-27
14,0 cm, Ø 22 mm, 140 mm TR-25-320-22

TR-25-330-04 Sphincterblades95x22mmpair



Parks

TR-25-330-03 Rectalblades70x22mmpair



TR-25-330-06 Bladesforanastomosis90x22mmpair



TR-25-330-00 Parks, complete

consisting of:

- TR-25-330-01** spreader only
- TR-25-330-02** central blade 95 mm
- TR-25-330-03** Rectal blades 70x22 mm pair
- TR-25-330-04** Sphincter blades 95x22 mm pair
- TR-25-330-06** blades for anastomosis 90x22 mm pair

TR-25-331-00 Parks, complete with fiber optic light carrier

Hemorrhoidal Ligator, Hemorrhoidal Grasping Forceps



Rubber Rings, Pack = 100 pieces
TR-25-350-99



Rudd

31,5 cm **TR-25-350-31**

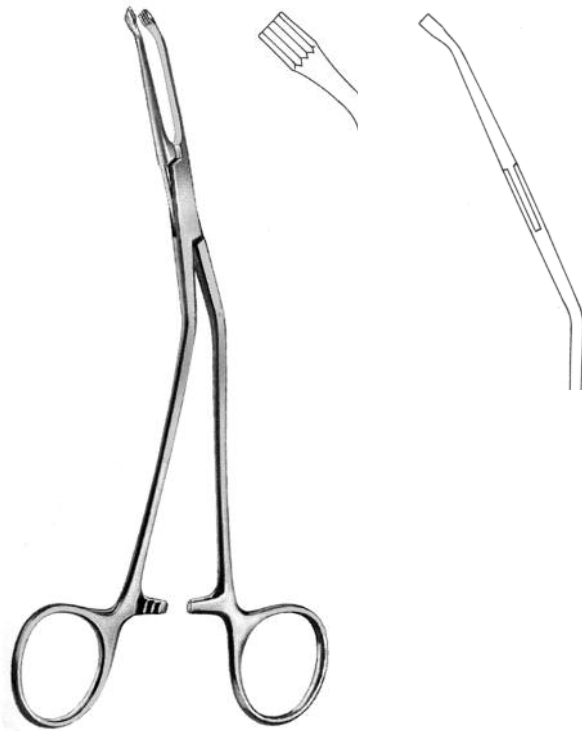

McGinvey

18,5 cm **TR-25-352-18**

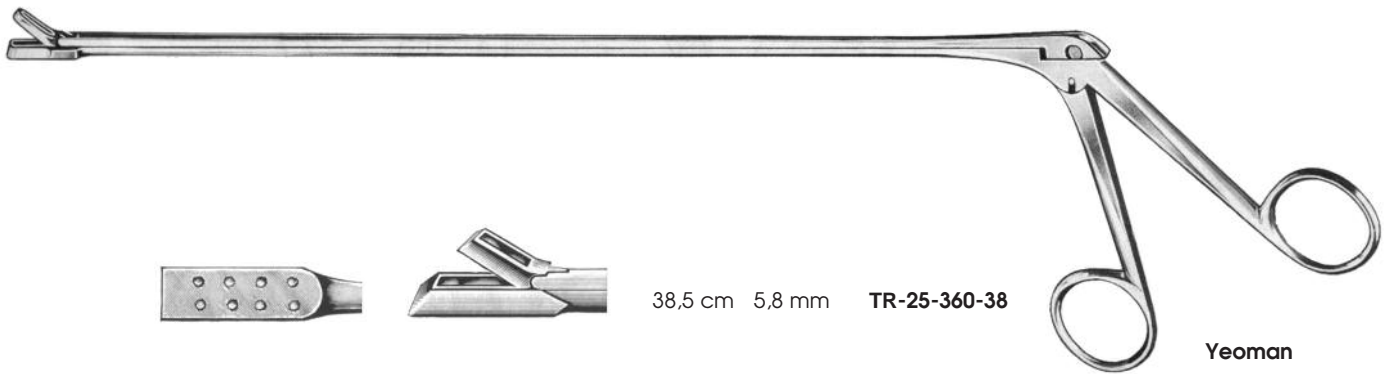

38,5 cm 5,8 mm **TR-25-360-38**

Yeoman



35,0 cm 4,0 mm **TR-25-362-35**
42,0 cm 4,0 mm **TR-25-362-42**

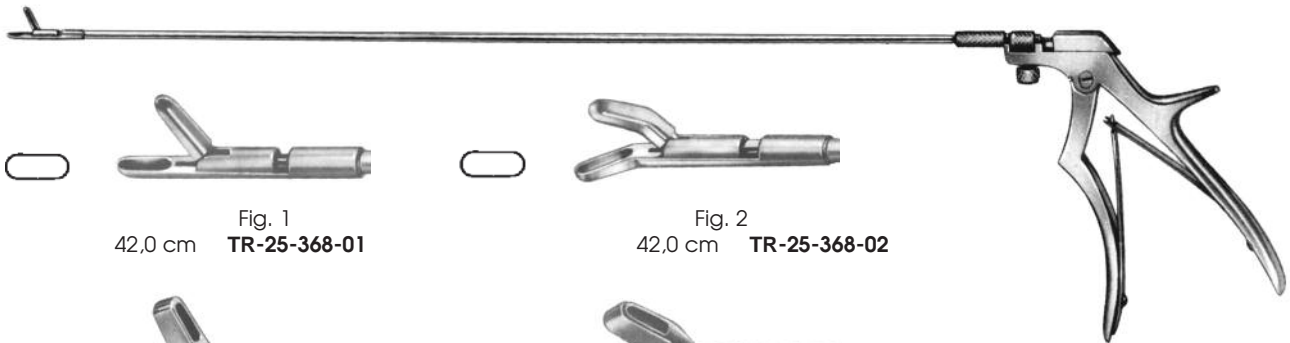

Fig. 1
42,0 cm **TR-25-368-01**



Fig. 2
42,0 cm **TR-25-368-02**



Fig. 3
42,0 cm **TR-25-368-03**

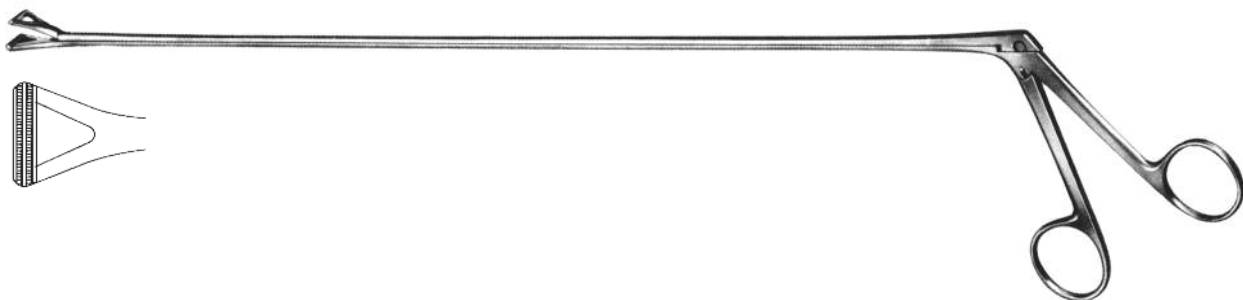

Fig. 4
42,0 cm **TR-25-368-04**

Handle only
TR-25-368-00



Fig. 5
42,0 cm **TR-25-368-05**



TR-25-370-38
38,0 cm 15 mm

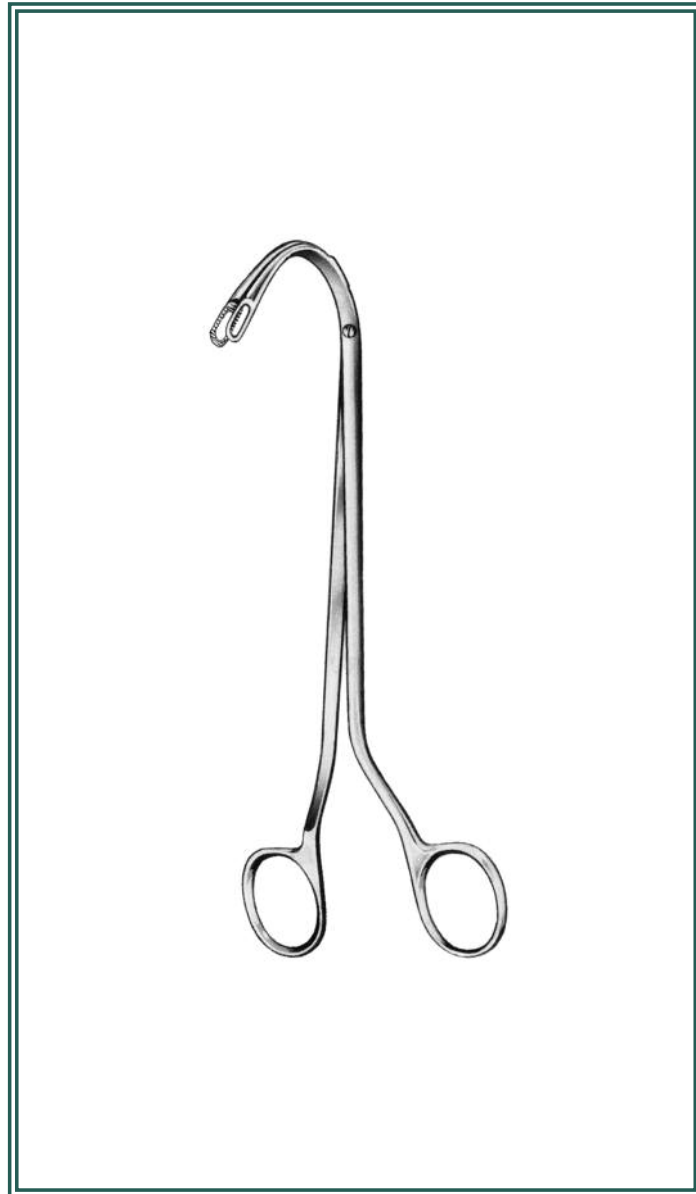

15

Liver, Gall Bladder, Kidney

Gall Duct Dilatators

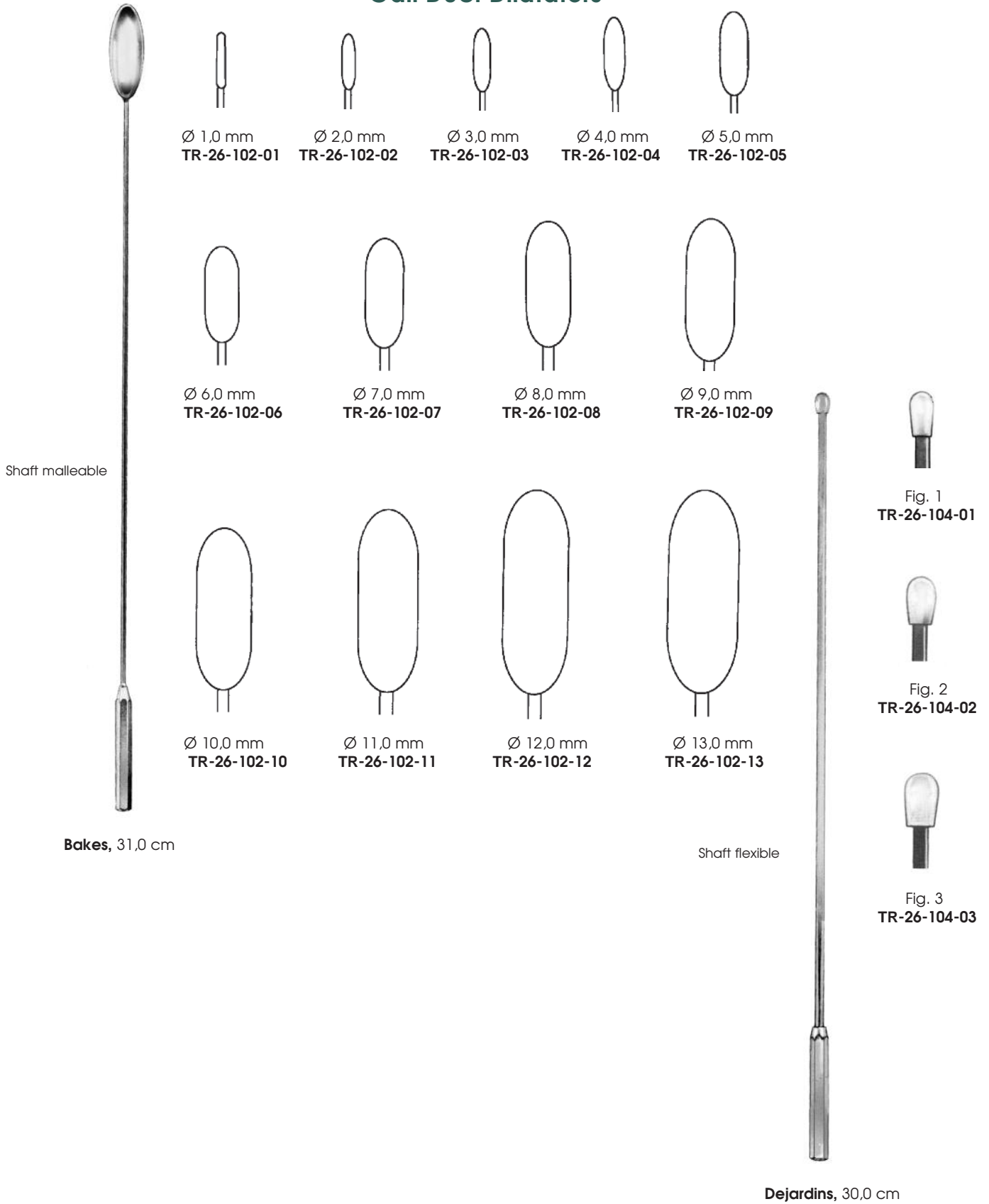



Shaft malleable

Luer-Koerte, 32,0 cm

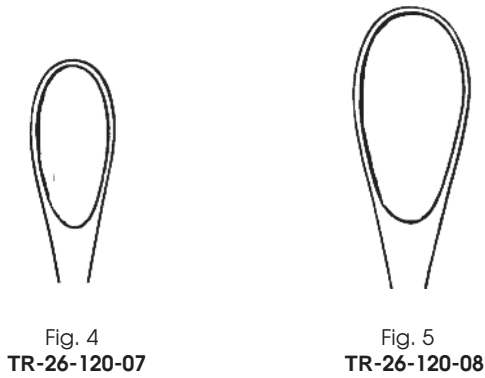
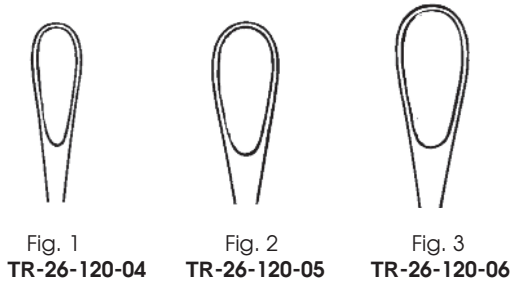
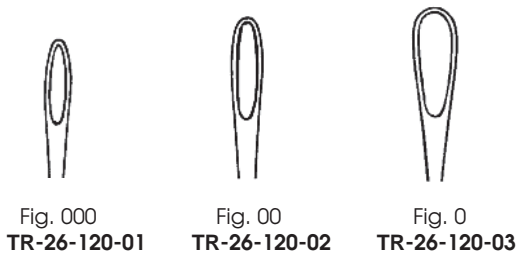

Shaft flexible

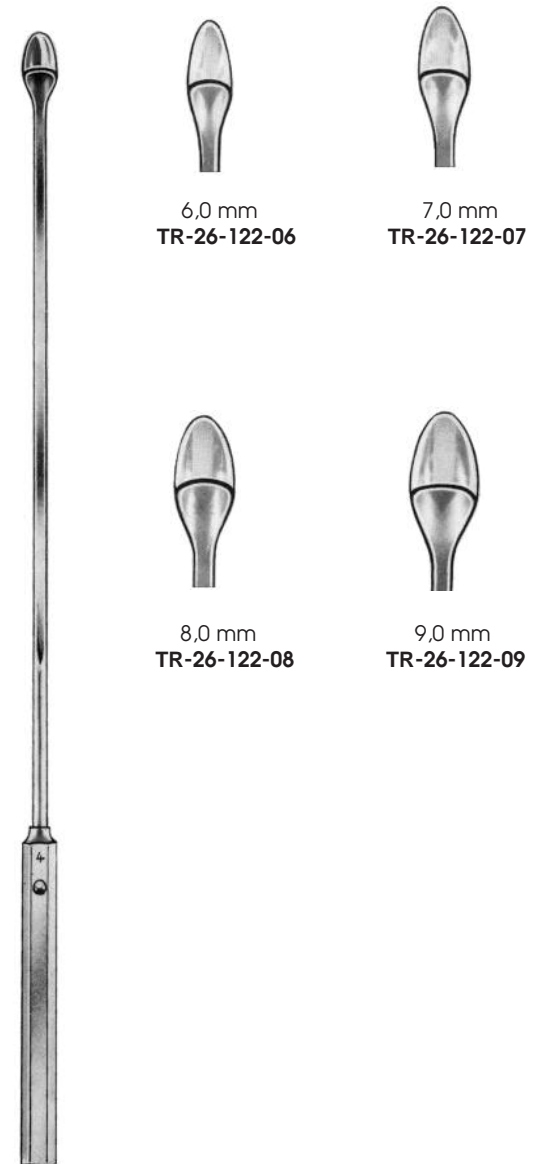

Dejardins, 30,0 cm

Kidney Stone Forceps

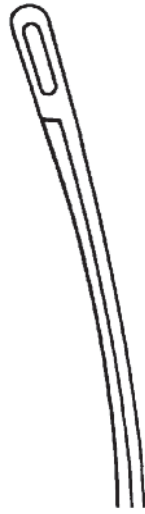

Fig. 1
TR-26-207-01

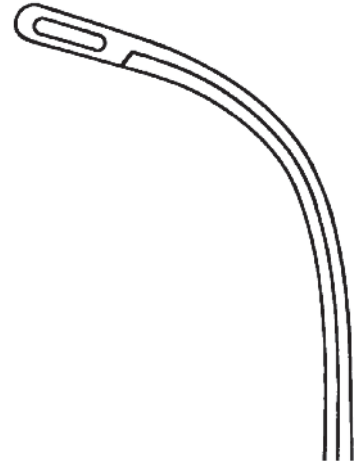
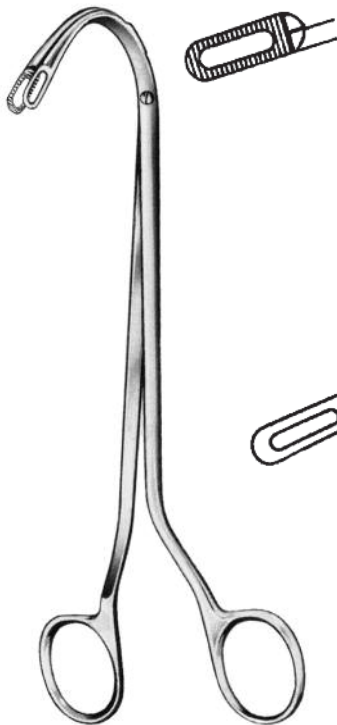

Fig. 2
TR-26-207-02



Randall

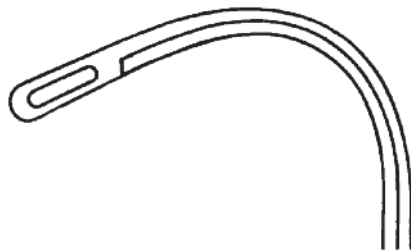

Fig. 3
TR-26-207-03



Fig. 4
TR-26-207-04

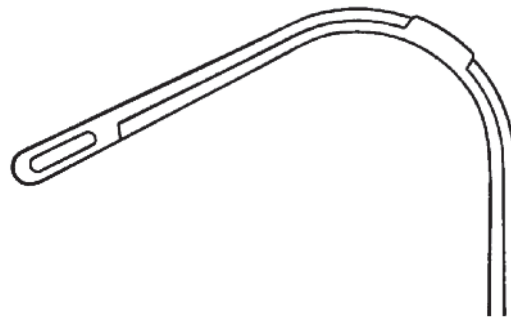

Fig. 5
TR-26-209-05

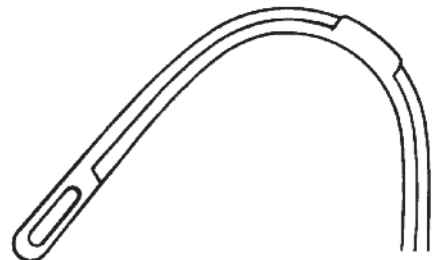
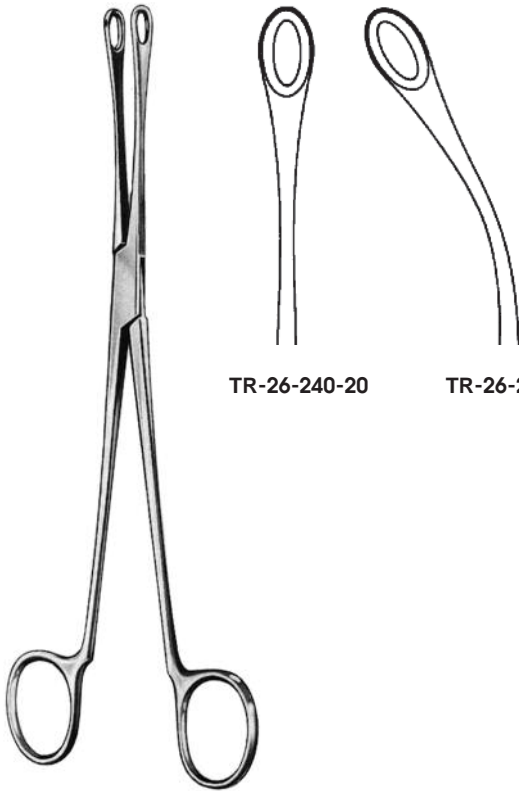

Fig. 6
TR-26-209-06



Blake, 20,0 cm

TR-26-240-20

TR-26-241-20

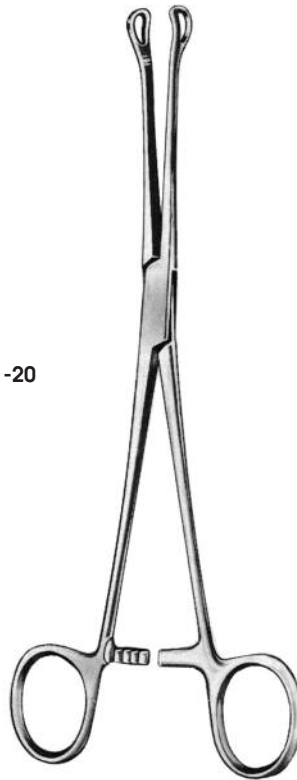

Mayo-Blake
20,0 cm TR-26-244-20



Mayo-Blake
20,0 cm TR-26-245-20



Mixer
22,0 cm TR-26-247-22

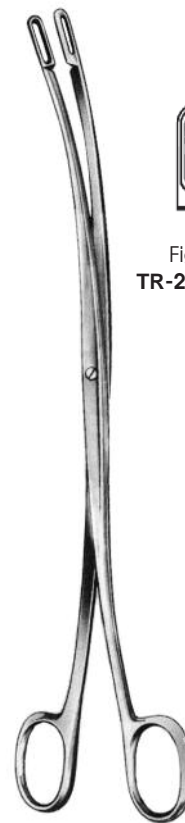

Dejardins



Fig. 1
TR-26-249-01



Fig. 2
TR-26-249-02

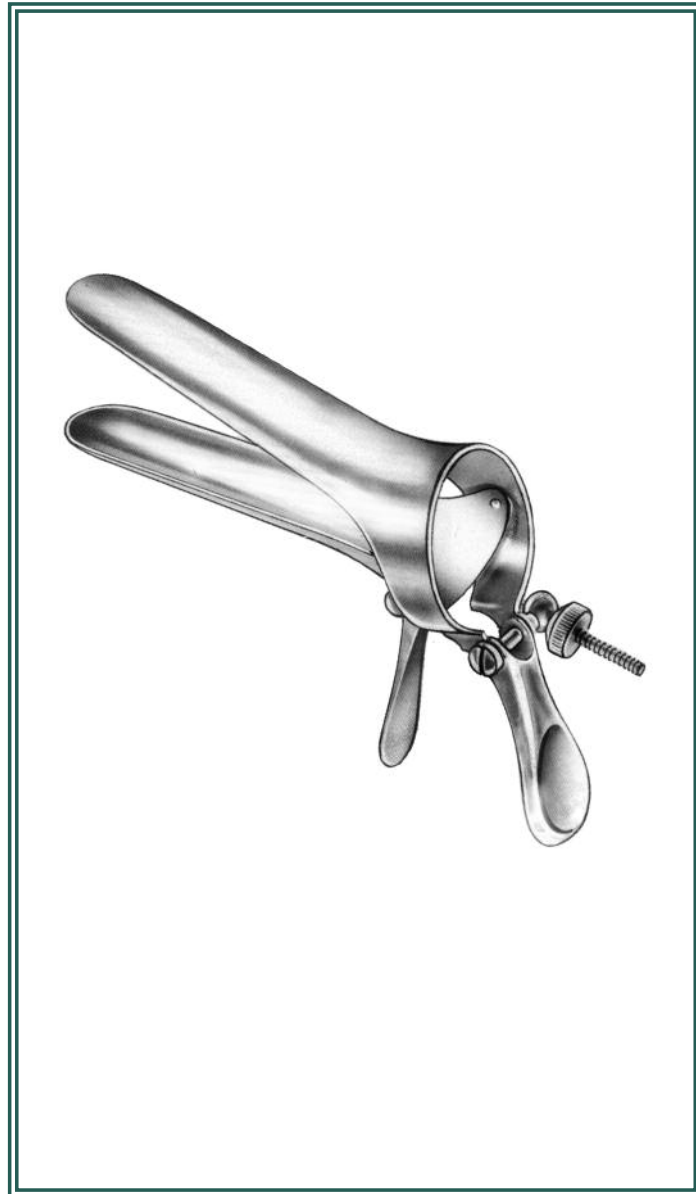

16

Gynecology

Vaginal Specula

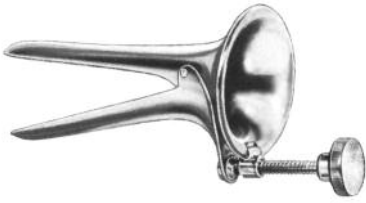

Collin
53x10 mm **TR-27-000-01**



Collin
85x18 mm **TR-27-001-01**
85x30 mm **TR-27-002-01**
100x35 mm **TR-27-002-02**
110x40 mm **TR-27-002-03**



Cusco
75x17 mm **TR-27-003-01**
75x32 mm **TR-27-005-01**
85x35 mm **TR-27-005-02**
100x35 mm **TR-27-005-03**



Cusco
75x17 mm **TR-27-003-02**
75x32 mm **TR-27-006-01**
85x35 mm **TR-27-006-02**
100x35 mm **TR-27-006-03**



Cusco, Schweizer Modell
90x22 mm **TR-27-007-01**
100x25 mm **TR-27-007-02**
105x27 mm **TR-27-007-03**

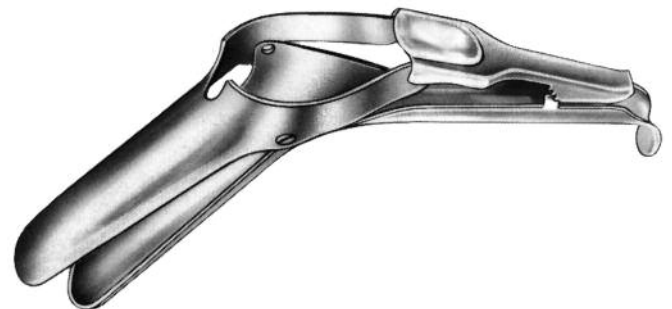

Semm
90x14-18 mm **TR-27-008-01**
100x17-20 mm **TR-27-008-02**
100x25-30 mm **TR-27-008-03**

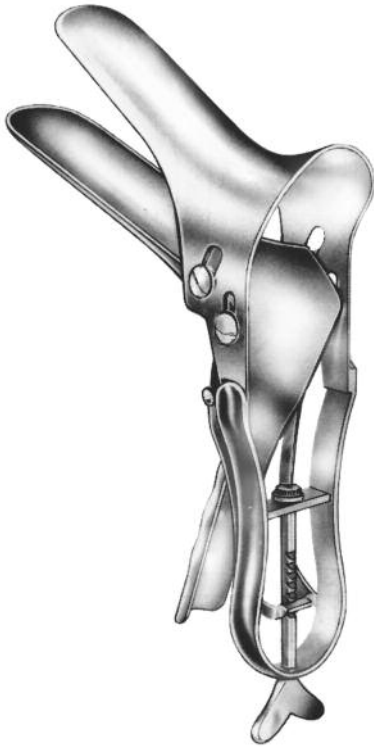

Seyffert

100x17 mm **TR-27-009-01**
110x33 mm **TR-27-009-02**

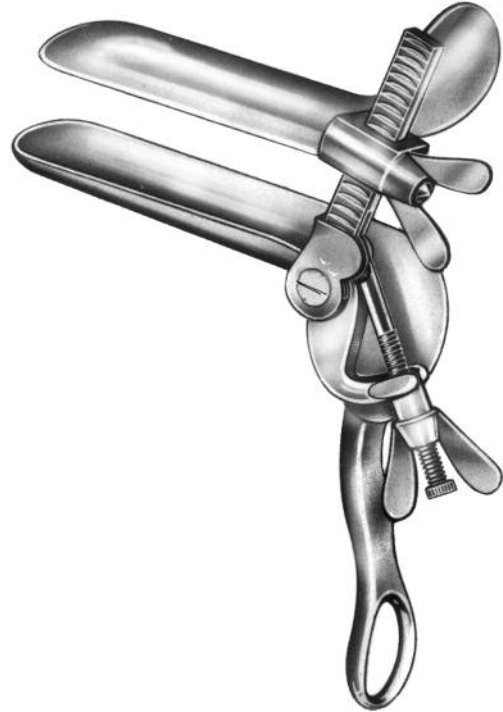

Trélat

85x33 mm **TR-27-011-01**
95x33 mm **TR-27-011-02**
115x43 mm **TR-27-011-03**

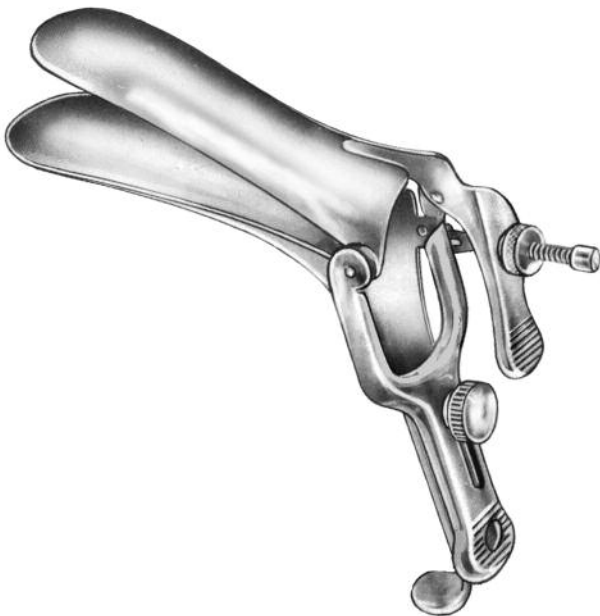

Grave

75x20 mm **TR-27-013-01**
95x35 mm **TR-27-013-02**
115x35 mm **TR-27-013-03**

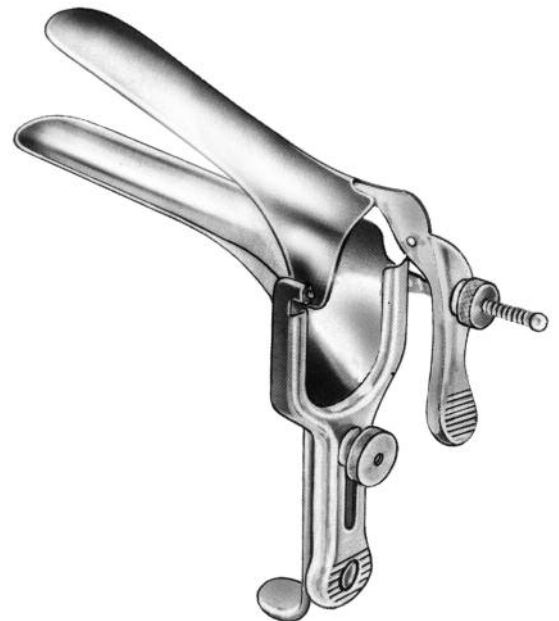

Pederson

75x13 mm **TR-27-014-01**
100x22 mm **TR-27-014-02**
120x25 mm **TR-27-014-03**

Vaginal Specula

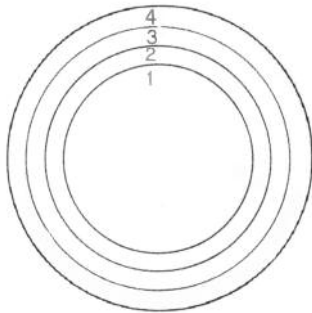

Ferguson

Set Fig. 1-4 **TR-27-016-00**

- Fig. 1, Ø 25 mm **TR-27-016-01**
- Fig. 2, Ø 30 mm **TR-27-016-02**
- Fig. 3, Ø 35 mm **TR-27-016-03**
- Fig. 4, Ø 40 mm **TR-27-016-04**



Sims

- 65x25/70x30 mm **TR-27-019-01**
- 70x30/70x35 mm **TR-27-019-02**
- 85x35/90x40 mm **TR-27-019-03**

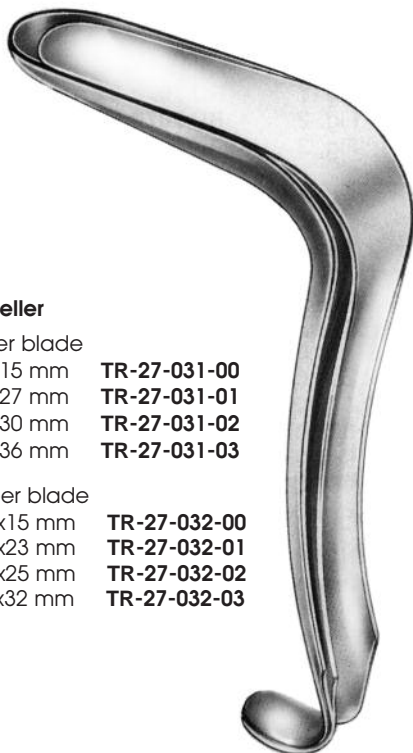

Kristeller

- lower blade
- 70x15 mm **TR-27-031-00**
- 70x27 mm **TR-27-031-01**
- 70x30 mm **TR-27-031-02**
- 90x36 mm **TR-27-031-03**

- upper blade
- 70x15 mm **TR-27-032-00**
- 70x23 mm **TR-27-032-01**
- 80x25 mm **TR-27-032-02**
- 100x32 mm **TR-27-032-03**

Kristeller

- Set 70x15 mm **TR-27-030-00**
- Set 70x27 mm **TR-27-030-01**
- Set 70x30 mm **TR-27-030-02**
- Set 90x36 mm **TR-27-030-03**

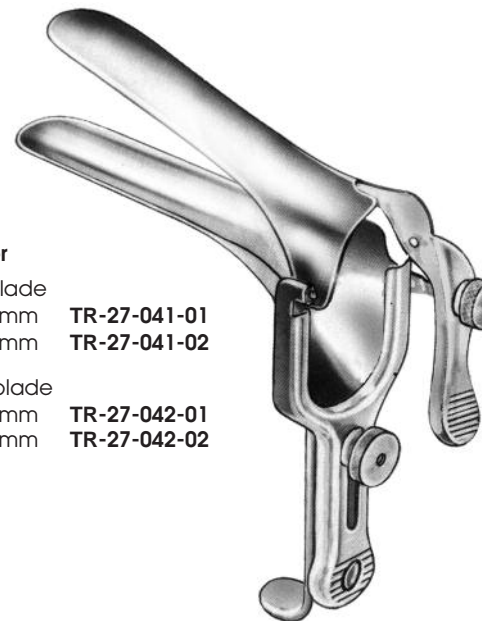

Kristeller

- lower blade
- 110x18 mm **TR-27-041-01**
- 110x20 mm **TR-27-041-02**

- upper blade
- 115x14 mm **TR-27-042-01**
- 115x16 mm **TR-27-042-02**

Kristeller

- Set 110x18 mm **TR-27-040-01**
- Set 110x20 mm **TR-27-040-02**

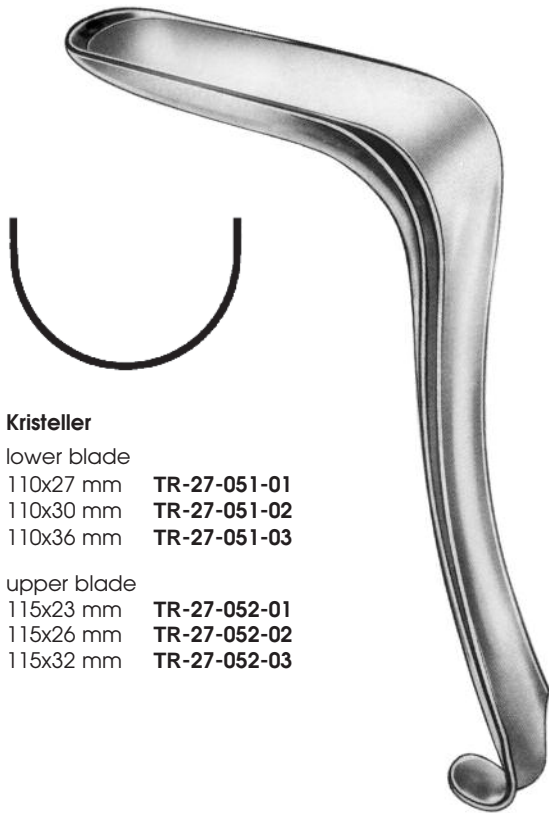

Kristeller

lower blade

110x27 mm **TR-27-051-01**

110x30 mm **TR-27-051-02**

110x36 mm **TR-27-051-03**

upper blade

115x23 mm **TR-27-052-01**

115x26 mm **TR-27-052-02**

115x32 mm **TR-27-052-03**

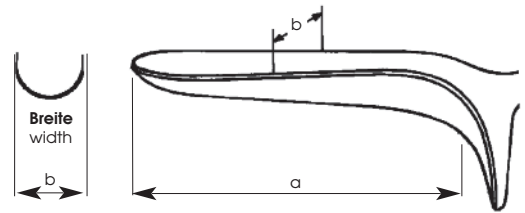

Kristeller

Set 110x27 mm **TR-27-050-01**

Set 110x30 mm **TR-27-050-02**

Set 110x36 mm **TR-27-050-03**

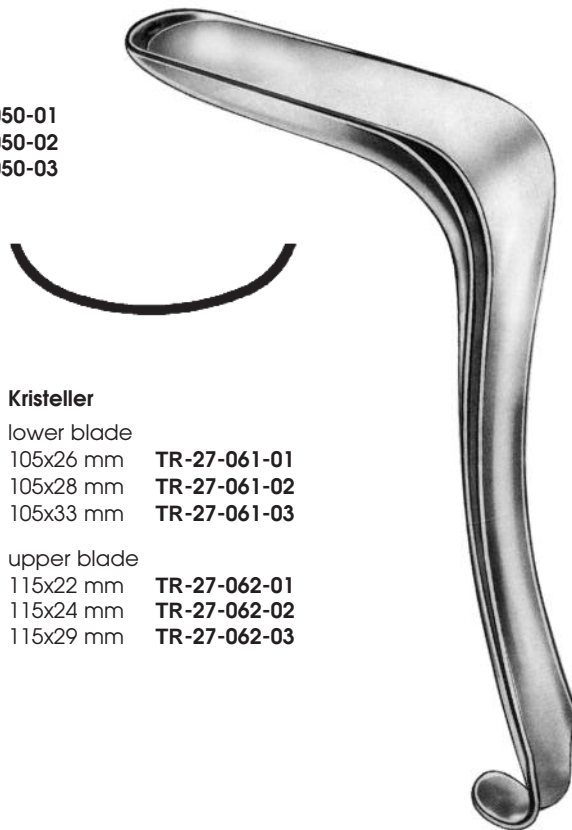

Kristeller

lower blade

105x26 mm **TR-27-061-01**

105x28 mm **TR-27-061-02**

105x33 mm **TR-27-061-03**

upper blade

115x22 mm **TR-27-062-01**

115x24 mm **TR-27-062-02**

115x29 mm **TR-27-062-03**

Kristeller

Set 105x26 mm **TR-27-060-01**

Set 105x28 mm **TR-27-060-02**

Set 105x33 mm **TR-27-060-03**

Vaginal Specula

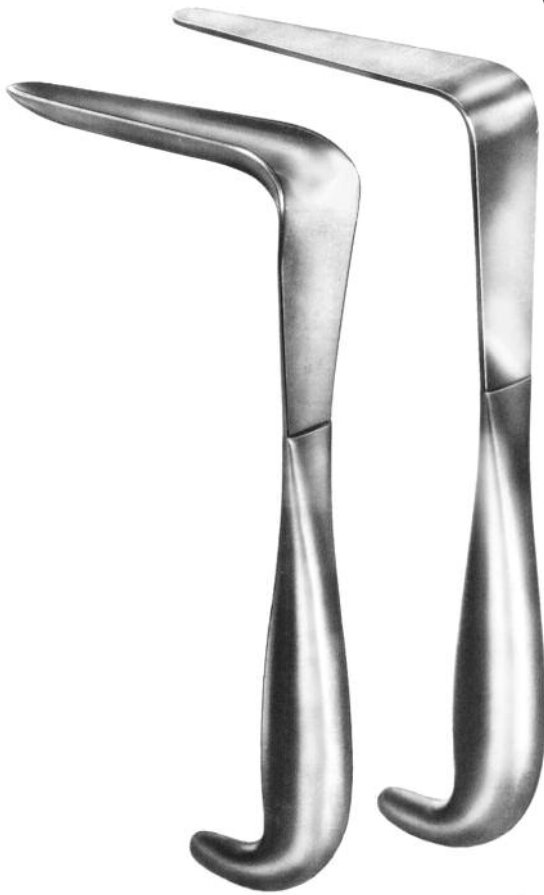

Kristeller "Wiener Modell"

lower blade
110x20 mm **TR-27-066-01**
110x30 mm **TR-27-066-02**
110x36 mm **TR-27-066-03**

upper blade
110x20 mm **TR-27-067-01**
110x30 mm **TR-27-067-02**
110x36 mm **TR-27-067-03**

Kristeller "Wiener Modell"

Set 110x20 mm **TR-27-065-01**
Set 110x30 mm **TR-27-065-02**
Set 110x36 mm **TR-27-065-03**



Kallmorgen

lower blade
70x40 mm **TR-27-071-01**
90x40 mm **TR-27-071-02**

upper blade
70x40 mm **TR-27-072-01**
90x40 mm **TR-27-072-02**

Kallmorgen

Set 70x40 mm **TR-27-070-01**
Set 90x40 mm **TR-27-070-02**

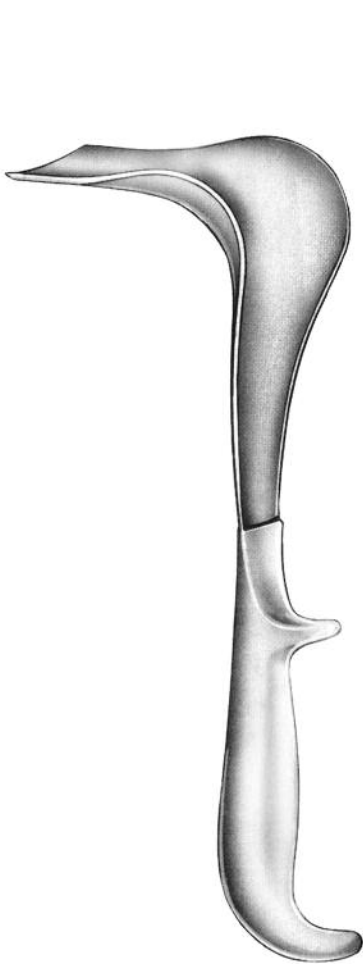

Doyen

60x45 mm **TR-27-081-01**
90x45 mm **TR-27-081-02**
112x45 mm **TR-27-081-03**



Doyen

60x30 mm **TR-27-081-60**
70x30 mm **TR-27-081-70**
80x30 mm **TR-27-081-80**



Doyen

55x35 mm **TR-27-082-01**
85x35 mm **TR-27-082-02**
115x35 mm **TR-27-082-03**

55x45 mm **TR-27-083-01**
85x45 mm **TR-27-083-02**
115x45 mm **TR-27-083-03**
160x45 mm **TR-27-083-04**

55x60 mm **TR-27-084-01**
85x60 mm **TR-27-084-02**
115x60 mm **TR-27-084-03**
160x60 mm **TR-27-084-04**

Vaginal Specula



Landau

100x28 mm **TR-27-086-28**
110x38 mm **TR-27-086-38**



Breisky

100x20 mm **TR-27-087-20**
100x25 mm **TR-27-087-25**
100x30 mm **TR-27-087-30**
100x35 mm **TR-27-087-35**
100x40 mm **TR-27-087-40**

130x20 mm **TR-27-088-20**
130x25 mm **TR-27-088-25**
130x30 mm **TR-27-088-30**
130x35 mm **TR-27-088-35**
130x40 mm **TR-27-088-40**



Breisky

160x40 mm **TR-27-089-40**
180x40 mm **TR-27-090-40**



80x30 mm **TR-27-092-01**



55x40/60 mm **TR-27-092-04**



85x35 mm **TR-27-092-02**



70x45/70 mm **TR-27-092-05**



90x40 mm **TR-27-092-03**



Weight only

400 gr. **TR-27-092-1**
800 gr. **TR-27-092-1**



Handle only

TR-27-092-1

Scherback, complete

TR-27-092-00

Set consisting of:

- TR-27-092-01** blade
- TR-27-092-02** blade
- TR-27-092-03** blade
- TR-27-092-04** blade
- TR-27-092-10** weight
- TR-27-092-12** handle



Auvard

75x45-40 mm **TR-27-093-01**
105x43-40 mm **TR-27-093-02**



Weissbarth, kompett

80x28 mm **TR-27-094-28**
85x42 mm **TR-27-094-42**

perforated bottom only

TR-27-094-99

Spreader, Endospecula

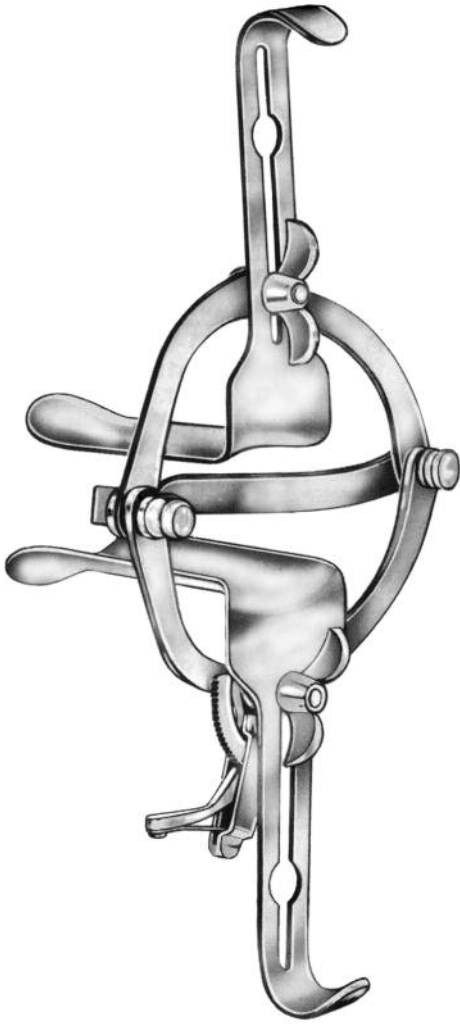

O'Sullivan-O'Connor, komplett
TR-27-095-00



Friedmann
15,5 cm TR-27-096-00



Kogan
24,0 cm TR-27-097-24

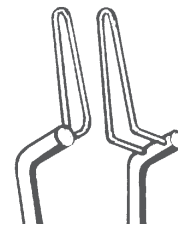

Kogan
with ratchet
24,0 cm TR-27-098-24

Hegar



Ø			Ø
1,0 mm	TR-27-100-01	1,5 mm	TR-27-105-01
2,0 mm	TR-27-100-02	2,5 mm	TR-27-105-02
3,0 mm	TR-27-100-03	3,5 mm	TR-27-105-03
4,0 mm	TR-27-100-04	4,5 mm	TR-27-105-04
5,0 mm	TR-27-100-05	5,5 mm	TR-27-105-05
6,0 mm	TR-27-100-06	6,5 mm	TR-27-105-06
7,0 mm	TR-27-100-07	7,5 mm	TR-27-105-07
8,0 mm	TR-27-100-08	8,5 mm	TR-27-105-08
9,0 mm	TR-27-100-09	9,5 mm	TR-27-105-09
10,0 mm	TR-27-100-10	10,5 mm	TR-27-105-10
11,0 mm	TR-27-100-11	11,5 mm	TR-27-105-11
12,0 mm	TR-27-100-12	12,5 mm	TR-27-105-12
13,0 mm	TR-27-100-13	13,5 mm	TR-27-105-13
14,0 mm	TR-27-100-14	14,5 mm	TR-27-105-14
15,0 mm	TR-27-100-15	15,5 mm	TR-27-105-15
16,0 mm	TR-27-100-16	16,5 mm	TR-27-105-16
17,0 mm	TR-27-100-17	17,5 mm	TR-27-105-17
18,0 mm	TR-27-100-18		
19,0 mm	TR-27-100-19		
20,0 mm	TR-27-100-20		
21,0 mm	TR-27-100-21		
22,0 mm	TR-27-100-22		
23,0 mm	TR-27-100-23		
24,0 mm	TR-27-100-24		
25,0 mm	TR-27-100-25		
26,0 mm	TR-27-100-26		
27,0 mm	TR-27-100-27		
28,0 mm	TR-27-100-28		
29,0 mm	TR-27-100-29		
30,0 mm	TR-27-100-30		
32,0 mm	TR-27-100-32		
34,0 mm	TR-27-100-34		



TR-27-106-14

Set with 14 pieces
4,0 - 17,0 mm
in metal case



TR-27-106-26

Set with 26 pieces
1,0 - 26,0 mm
in metal case

Uterine Dilators



Hegar	
Ø	
1- 2 mm	TR-27-110-02
3- 4 mm	TR-27-110-04
5- 6 mm	TR-27-110-06
7- 8 mm	TR-27-110-08
9-10 mm	TR-27-110-10
11-12 mm	TR-27-110-12
13-14 mm	TR-27-110-14
15-16 mm	TR-27-110-16
17-18 mm	TR-27-110-18
19-20 mm	TR-27-110-20
21-22 mm	TR-27-110-22
23-24 mm	TR-27-110-24
25-26 mm	TR-27-100-26

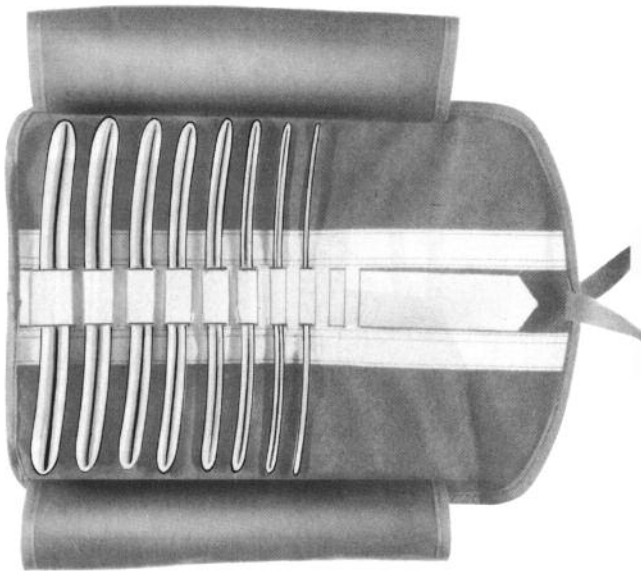

TR-27-111-08

Set with 8 pieces
Ø3,0/4,0 - 17,0/18,0 mm
in canvas roll



TR-27-112-08

Set with 8 pieces
Ø3,0/4,0 - 17,0/18,0 mm
in metal case

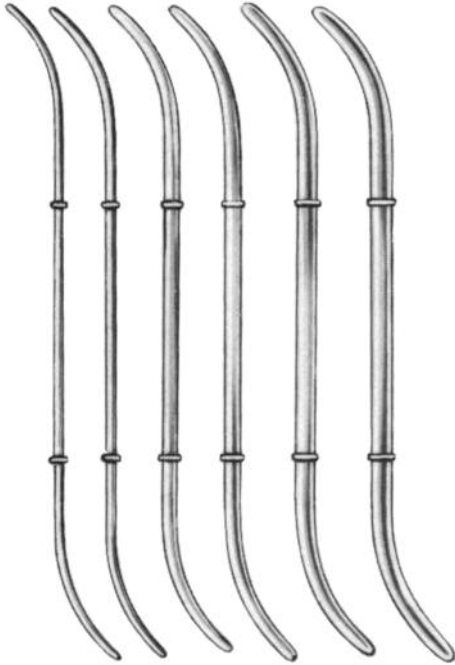

Hank
TR-27-117-01 - TR-27-117-06

Fig.	Ø	Hank
1	4,5/ 5,0 mm	TR-27-117-01
2	5,5/ 6,0 mm	TR-27-117-02
3	6,5/ 7,0 mm	TR-27-117-03
4	7,5/ 8,0 mm	TR-27-117-04
5	8,5/ 9,0 mm	TR-27-117-05
6	9,5/10,0 mm	TR-27-117-06

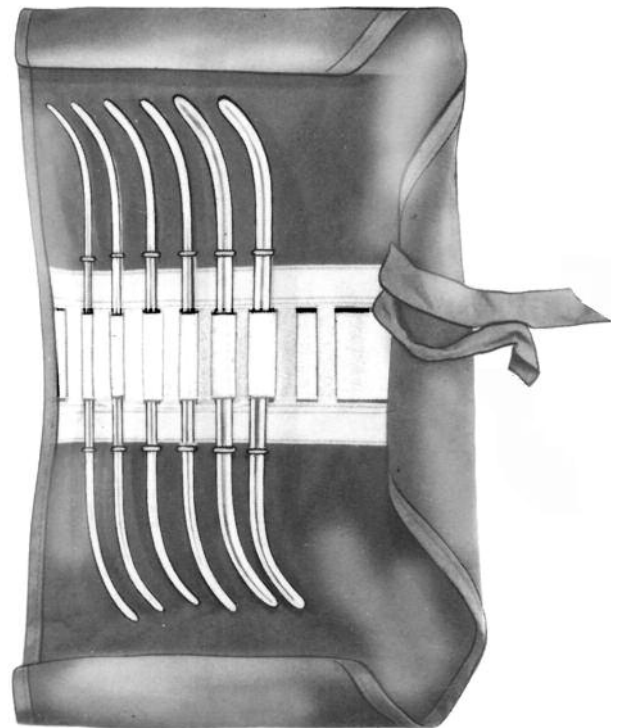

Hank
TR-27-117-99

Set Fig. 1-6 in canvas roll

Uterine Probe, Uterine Depressor



Sims

33,0 cm **TR-27-120-32**

33,0 cm **TR-27-121-32**

flexible



Martin

33,0 cm **TR-27-122-32**

33,0 cm **TR-27-123-32**

flexible



Braun

27,5 cm **TR-27-200-26**



Blake

26,0 cm **TR-27-202-27**

Tenaculum Forceps



Schröder
25,0 cm TR-27-204-25



Braun
25,0 cm TR-27-206-25

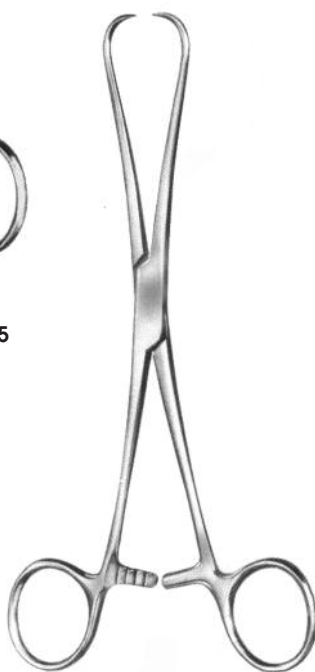

Pozzi
17,0 cm TR-27-208-17



Duplay
28,0 cm TR-27-209-28

Tenaculum Forceps



Pozzi

25,0 cm **TR-27-210-25**
26,0 cm **TR-27-210-26**



Skene

24,0 cm **TR-27-211-24**



Beacham

26,0 cm **TR-27-212-26**



Schröder

24,0 cm **TR-27-214-24**

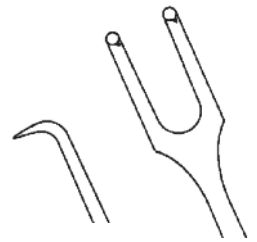

Schröder

24,0 cm **TR-27-215-24**



Teale
23,0 cm TR-27-217-23

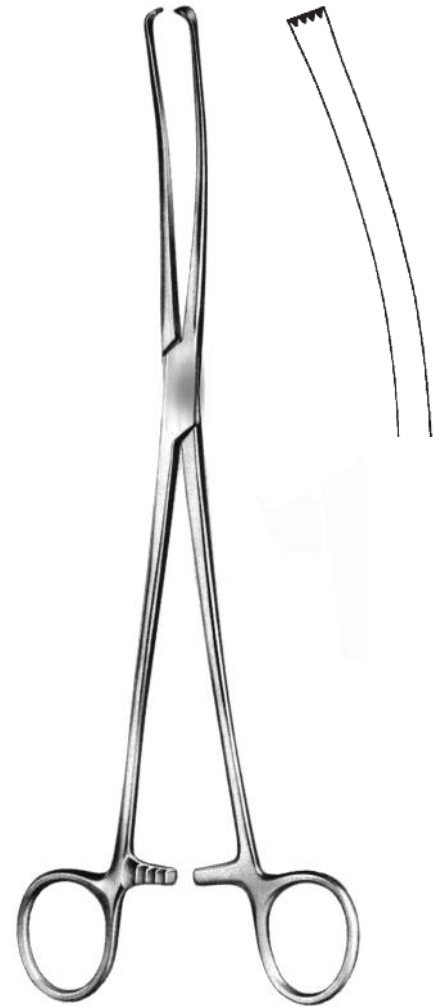

Iowa
26,0 cm TR-27-219-26

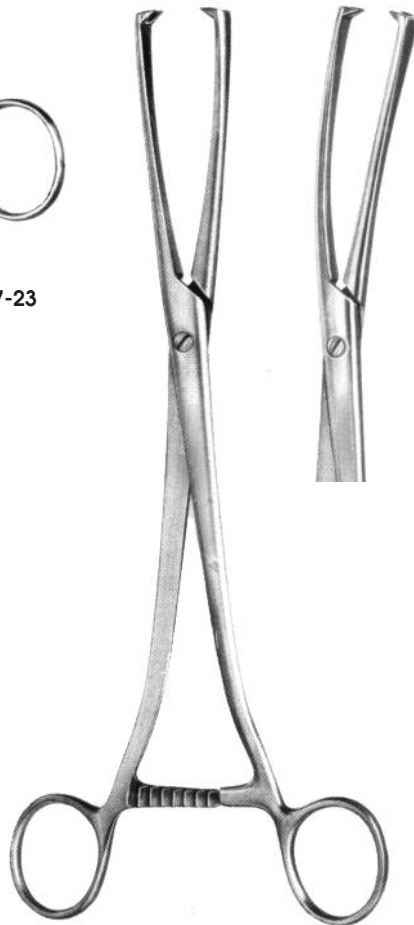

Museux, 26,0 cm
TR-27-220-06 - TR-27-221-10



6,0 mm
straight
curved sideways

TR-27-220-06
TR-27-221-06



8,0 mm
straight
curved sideways

TR-27-220-08
TR-27-221-08



10,0 mm
straight
curved sideways

TR-27-220-10
TR-27-221-10

Tenaculum Forceps

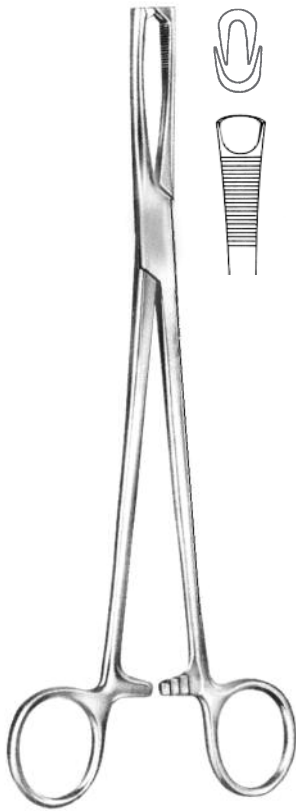

Jacobs
21,0 cm TR-27-222-21

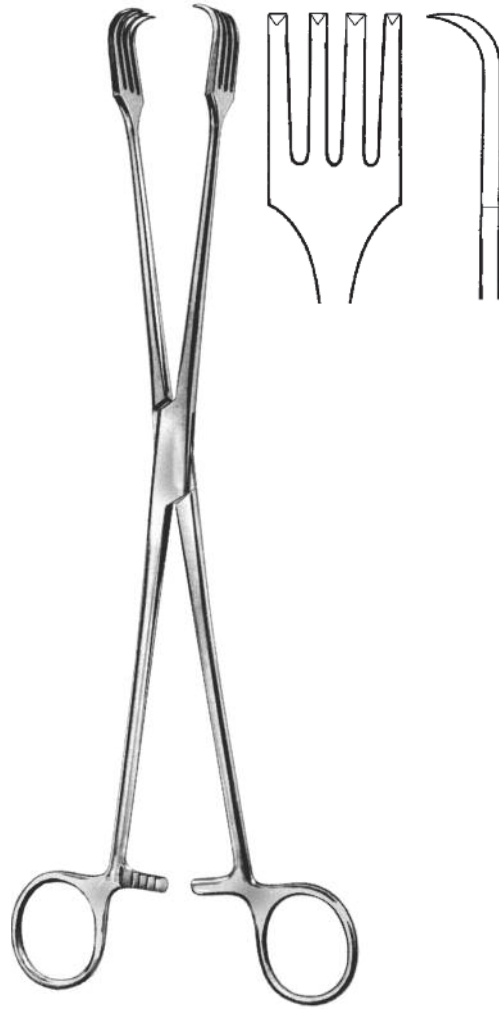

Pratt
26,0 cm TR-27-224-28



Cerny
21,0 cm TR-27-226-21

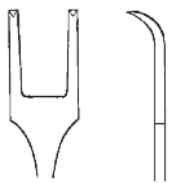

Lahey, 2x2
15,5 cm TR-27-228-01



Lahey, 3x3
15,5 cm TR-27-228-02

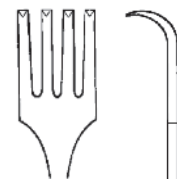

Braun, 4x4
15,5 cm TR-27-228-03

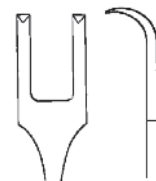

Museux, 2x2
20,0 cm TR-27-228-04

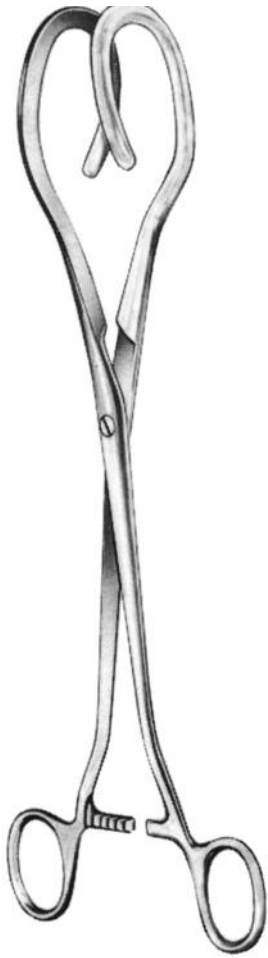

Dartigues
25,5 cm TR-27-230-22



Somer
23,5 cm TR-27-231-23

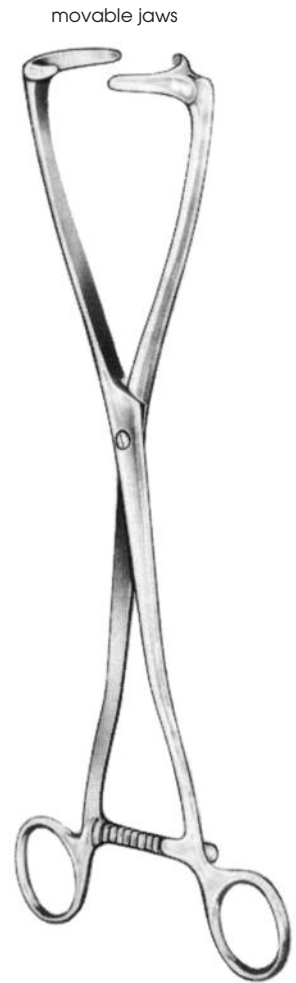

Collin
25,5 cm TR-27-232-25



Doyen
16,5 cm TR-27-233-17

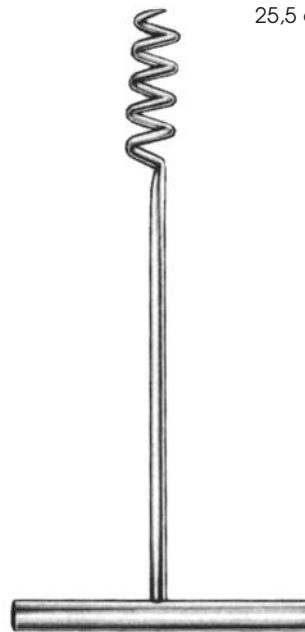

Doyen
17 cm TR-27-234-17

Aspirating Curettes

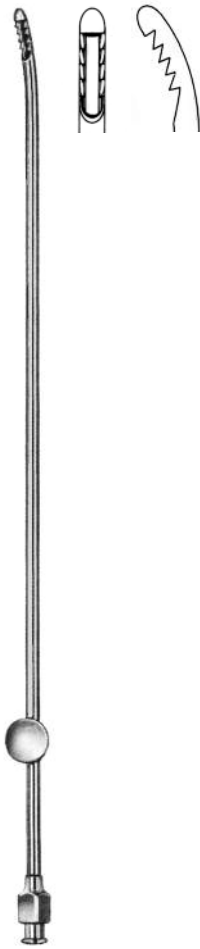

Novak, 24,0 cm

- Ø 1,0 mm **TR-27-301-01**
- Ø 2,0 mm **TR-27-301-02**
- Ø 3,0 mm **TR-27-301-03**
- Ø 4,0 mm **TR-27-301-04**

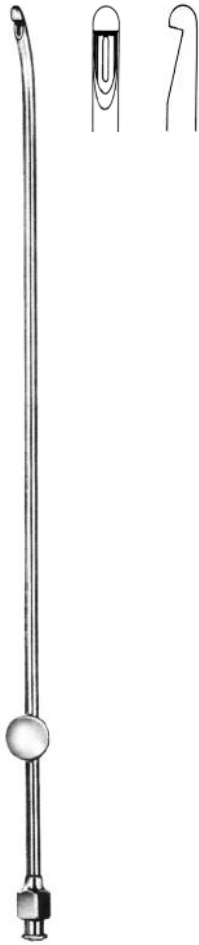

Randall, 24 cm

- Ø 4,0 mm **TR-27-303-04**

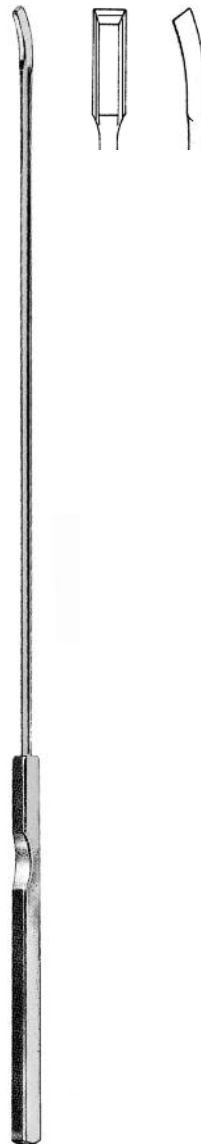

Kevorkian, 30,0 cm

- Ø 4,0 mm **TR-27-305-04**

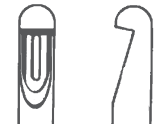

Modell Berlin, 27,0 cm
Ø 3,5 mm **TR-27-307-03**

Modell München, 27,0 cm
Ø 4,0 mm **TR-27-307-04**

Modell München, 27,0 cm
Ø 5,0 mm **TR-27-307-05**





24 cm
Ø 3,0 mm **TR-27-309-03**



Ø 4,5 mm
TR-27-309-04



Ø 6,0 mm
TR-27-309-06



Ø 8,0 mm
TR-27-309-08



Ø 10,0 mm
TR-27-309-10



Ø 12,0 mm
TR-27-309-12



Ø 14,0 mm
TR-27-309-14



TR-27-309-50

Spare rings for hose connection (pair)

TR-27-309-99

Salpingograph

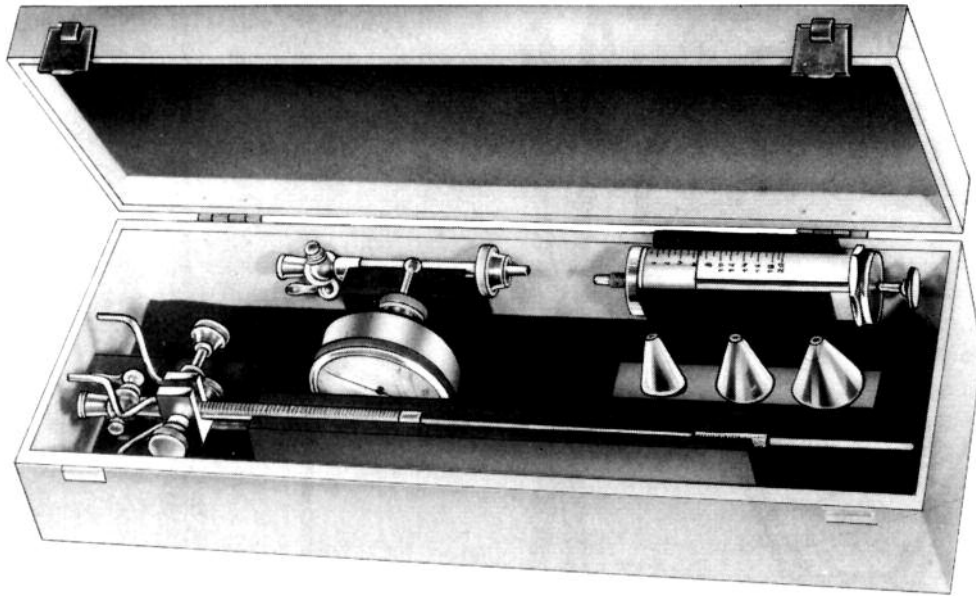

TR-27-320-00

complete in wood case TR-27-330-00

TR-27-340-00 Manometer only



Faure

21,0 cm **TR-27-401-21**
24,0 cm **TR-27-401-24**



Schubert

21,0 cm **TR-27-402-21**
29,0 cm **TR-27-402-29**

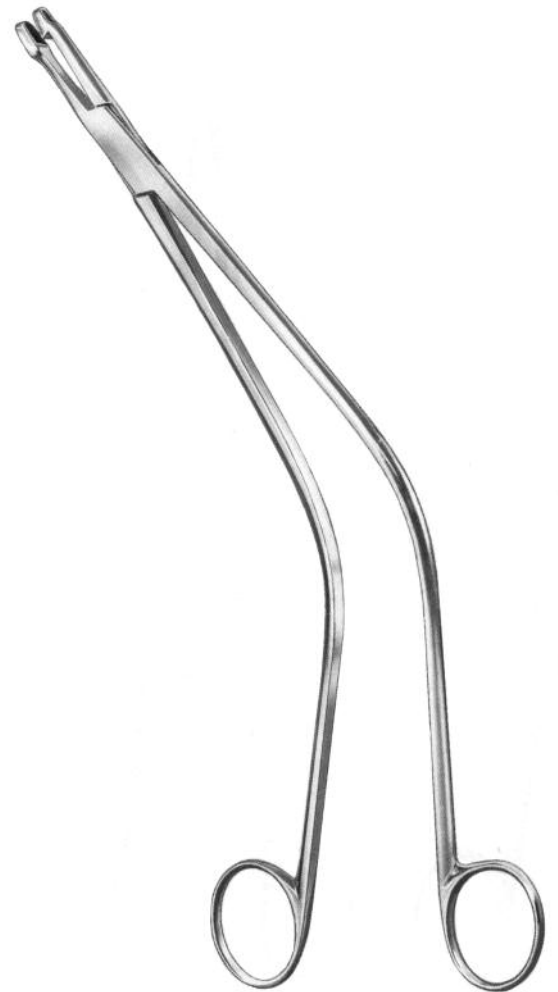

Schubert

26,0 cm **TR-27-403-26**

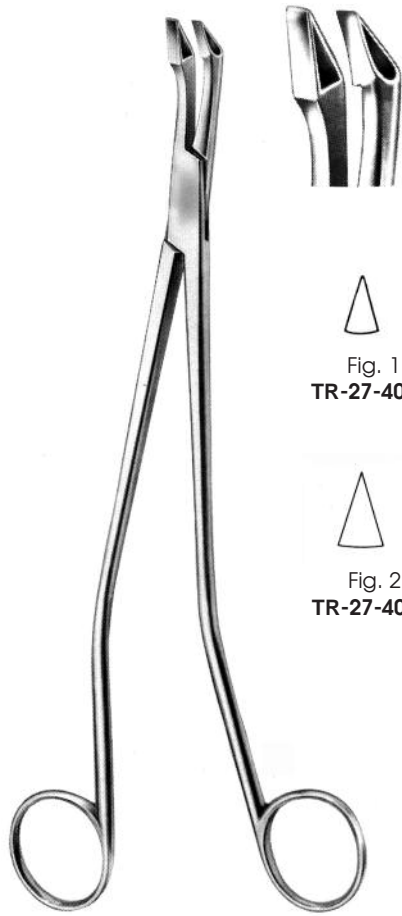

Schumacher, 24,0 cm



Fig. 1
TR-27-405-24



Fig. 2
TR-27-405-25

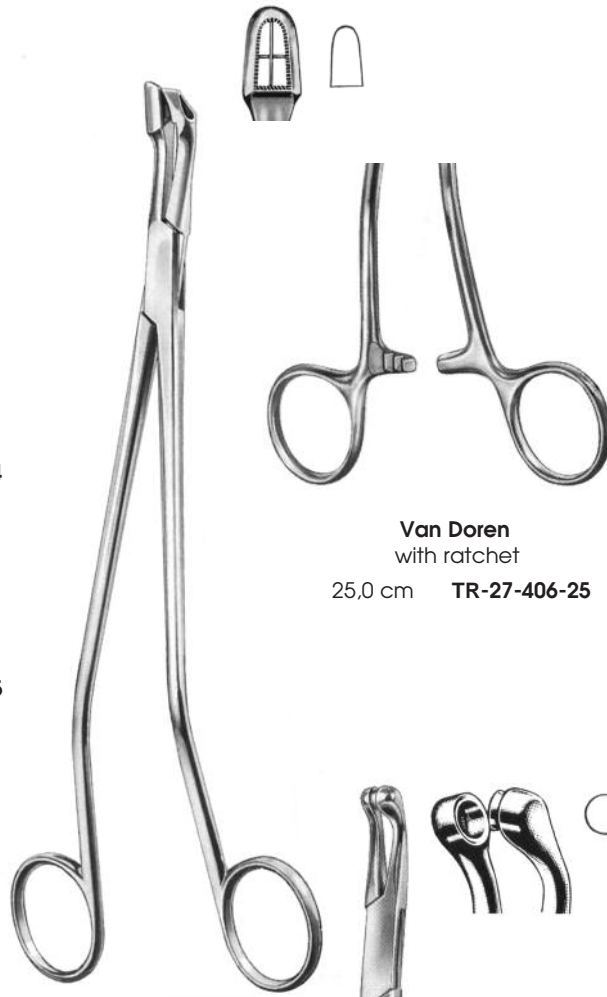

Van Doren
with ratchet
25,0 cm **TR-27-406-25**

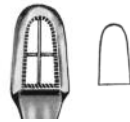

Van Doren
without ratchet
25,0 cm **TR-27-406-26**

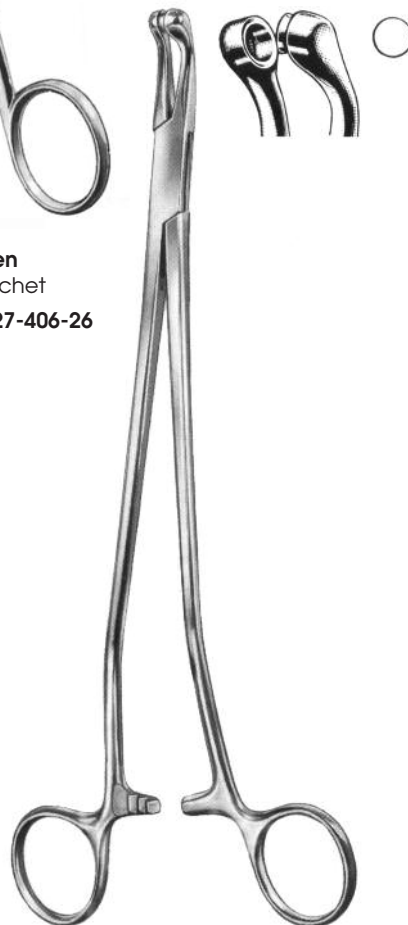

Thoms-Gaylor
s-curved
24,0 cm **TR-27-407-24**



Gelhorn
23,0 cm **TR-27-409-23**

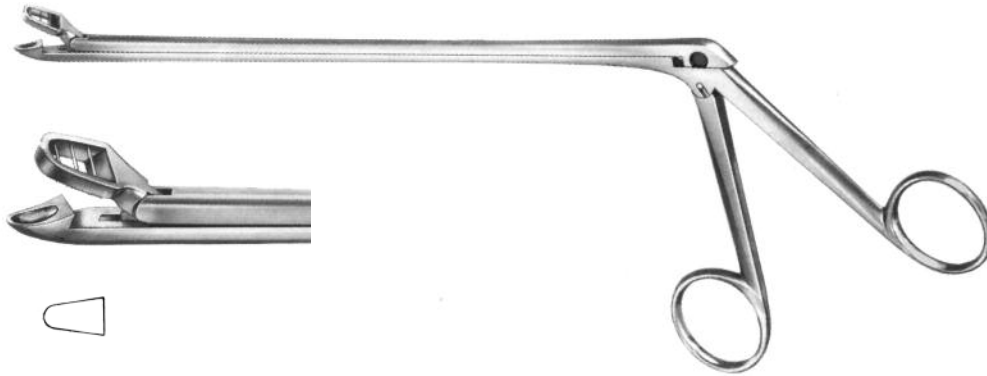

Alexander
28,0 cm **TR-27-410-28**

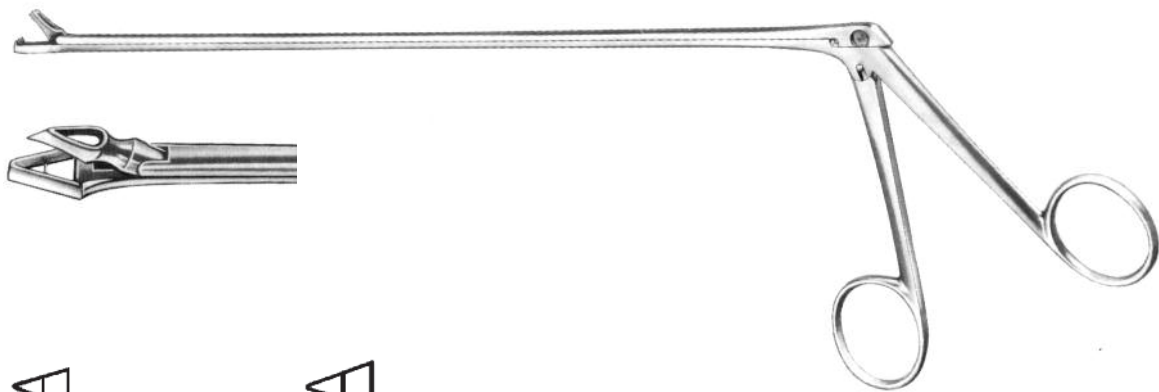

Fig. 1
TR-27-412-01

Fig. 2
TR-27-412-02

Schuhmacher, 24,0 cm



Eppendorf
20,0 cm **TR-27-414-20**



Kevorkian
24,5 cm **TR-27-416-24**

Uterine Scoopes

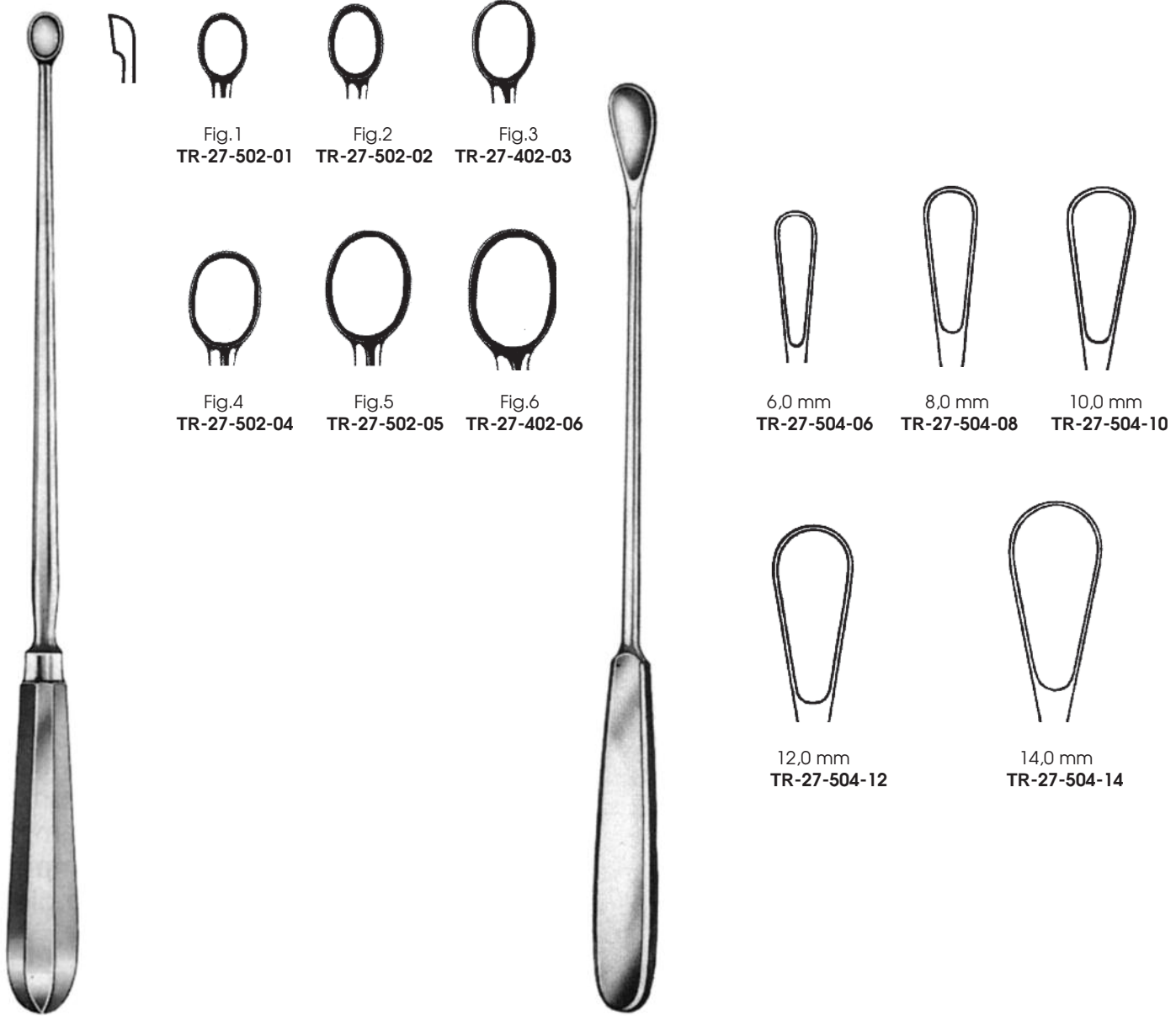

Schröder, 30,0 cm

Gourdet, 28,0 cm

Uterine Curettes



x	rigide/sharp	malleable/sharp
5 mm	TR-27-510-05	TR-27-511-05
6 mm	TR-27-510-06	TR-27-511-06
7 mm	TR-27-510-07	TR-27-511-07
8 mm	TR-27-510-08	TR-27-511-08
9 mm	TR-27-510-09	TR-27-511-09
11 mm	TR-27-510-11	TR-27-511-11
12 mm	TR-27-510-12	TR-27-511-12
14 mm	TR-27-510-14	TR-27-511-14
15 mm	TR-27-510-15	TR-27-511-15
16 mm	TR-27-510-16	TR-27-511-16
19 mm	TR-27-510-19	TR-27-511-19
20 mm	TR-27-510-20	TR-27-511-20
21 mm	TR-27-510-21	TR-27-511-21
23 mm	TR-27-510-23	TR-27-511-23
25 mm	TR-27-510-25	TR-27-511-25
30 mm	TR-27-510-30	TR-27-511-30
35 mm	TR-27-510-35	TR-27-511-35
40 mm	TR-27-510-40	TR-27-511-40



x	rigide/blunt	malleable/blunt
5 mm	TR-27-520-05	TR-27-521-05
6 mm	TR-27-520-06	TR-27-521-06
7 mm	TR-27-520-07	TR-27-521-07
8 mm	TR-27-520-08	TR-27-521-08
9 mm	TR-27-520-09	TR-27-521-09
11 mm	TR-27-520-11	TR-27-521-11
12 mm	TR-27-520-12	TR-27-521-12
14 mm	TR-27-520-14	TR-27-521-14
15 mm	TR-27-520-15	TR-27-521-15
16 mm	TR-27-520-16	TR-27-521-16
19 mm	TR-27-520-19	TR-27-521-19
20 mm	TR-27-520-20	TR-27-521-20
21 mm	TR-27-520-21	TR-27-521-21
23 mm	TR-27-520-23	TR-27-521-23
25 mm	TR-27-520-25	TR-27-521-25
30 mm	TR-27-520-30	TR-27-521-30
35 mm	TR-27-520-35	TR-27-521-35
40 mm	TR-27-520-40	TR-27-521-40

Recamier, ~ 28,0 cm
Recamier, ~ 31,0 cm

Sims, ~ 28,0 cm
Sims, ~ 31,0 cm

Pelvimeters



Martin
34,0 cm TR-27-701-34



Collin
35,0 cm TR-27-703-35

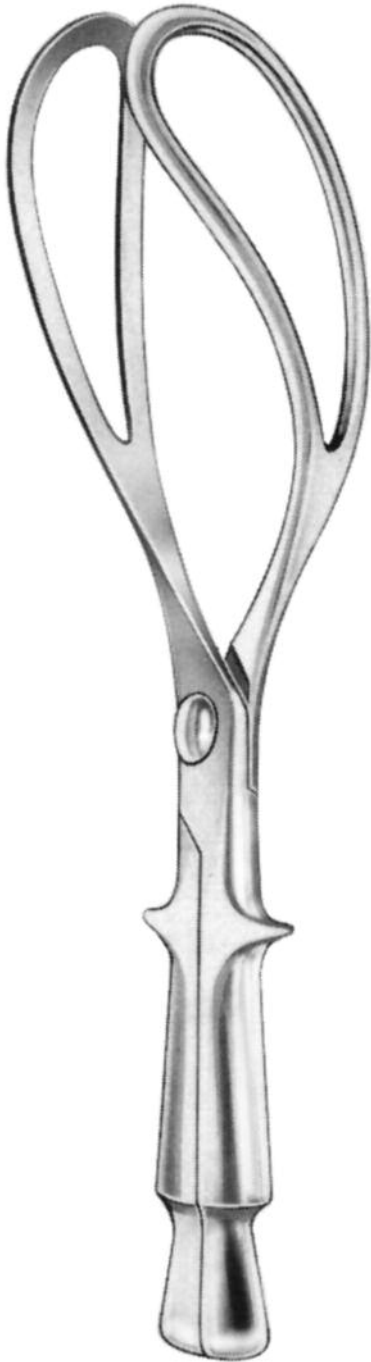

Nägele

36,0 cm **TR-27-711-36**
40,0 cm **TR-27-711-40**

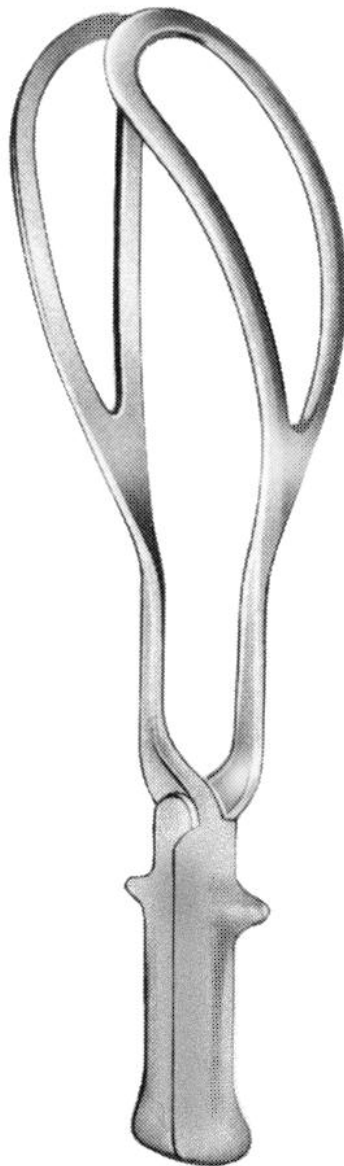

Simpson

30,0 cm **TR-27-713-30**
36,0 cm **TR-27-713-36**

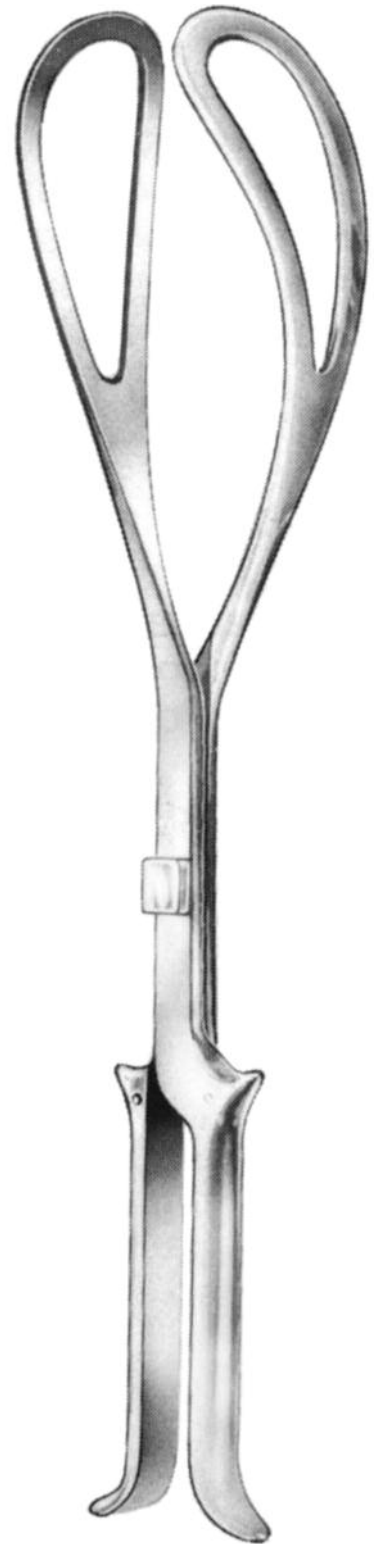

Kielland

41,0 cm **TR-27-715-41**

Obstetrics Instruments

Obstetric Lever



Sellheim

30,0 cm TR-27-731-28



Green-Armytage

22,0 cm TR-27-732-21

Umbilical Cord Clamps



Collin

9,0 cm TR-27-737-09

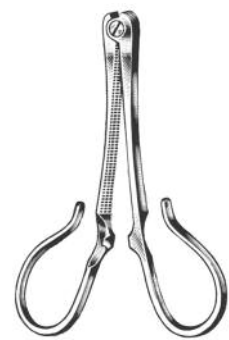

Kane

8,5 cm TR-27-739-09



Fig.1



Fig.2



Fig.3

straight
curved
curved

TR-27-750-01
TR-27-751-01
—

TR-27-750-02
TR-27-751-02
TR-27-751-12

TR-27-750-03
TR-27-751-03
TR-27-751-13

without ratched
without ratched
with ratched

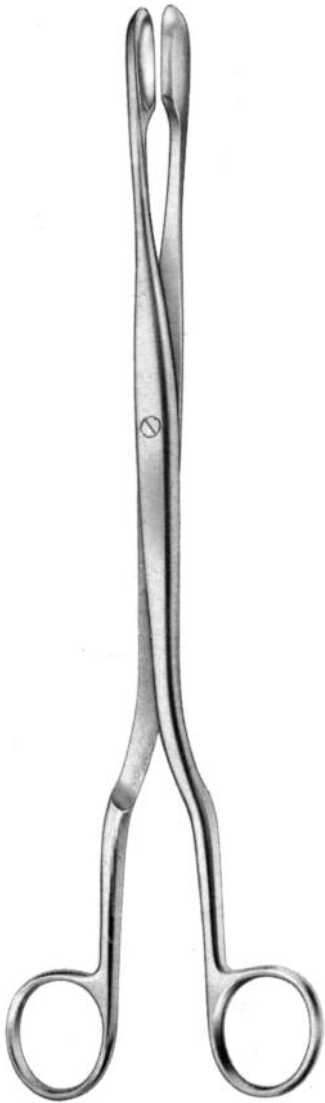

Winter, 29,0 cm

TR-27-750-01 - TR-27-750-03



Winter, 29,0 cm

TR-27-751-01 - TR-27-751-03

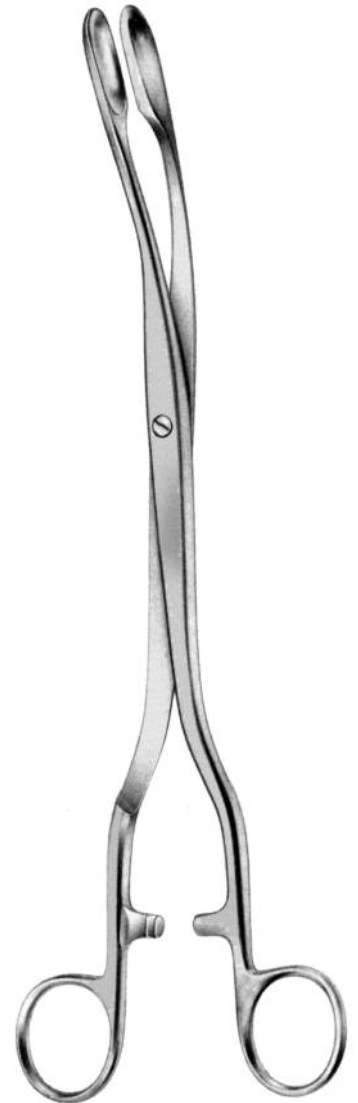

Winter, 29,0 cm

TR-27-751-12 - TR-27-751-13

Ovum Forceps, Ovum Curettes

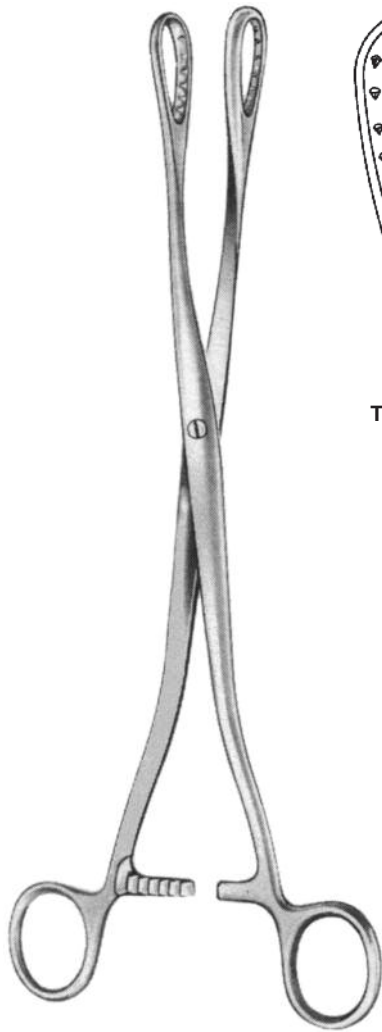

Saenger, 27,5 cm

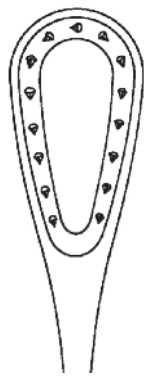

TR-27-752-27

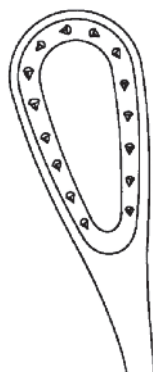

TR-27-753-27



Cuzzi, 30,0 cm



**18,0 mm
TR-27-754-18**



**14,0 mm
TR-27-754-14**



**20,0 mm
TR-27-754-20**



**Pestalozza
30,0 cm TR-27-756-30**



17

Genito-Urinary

Genito-Urinary Instruments

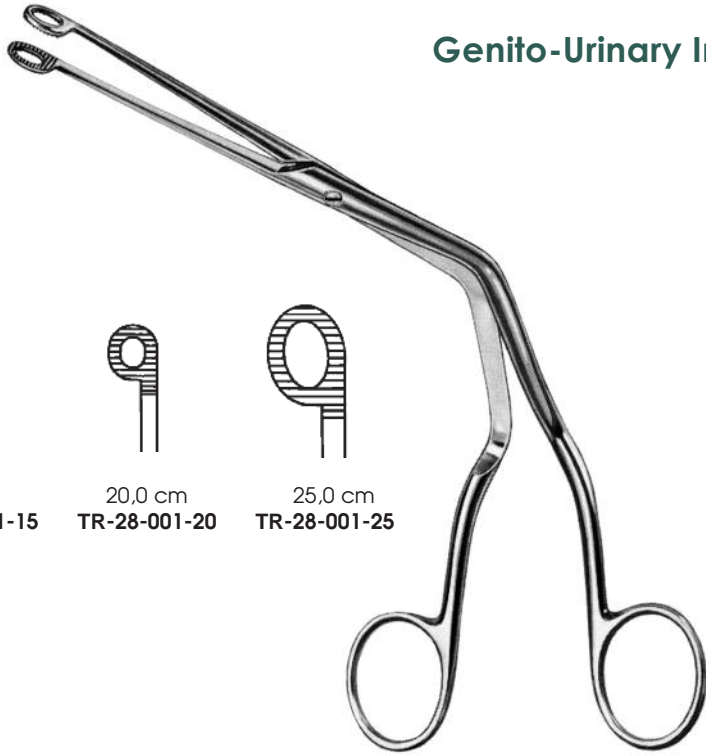

Magill



15,0 cm
TR-28-001-15



20,0 cm
TR-28-001-20



25,0 cm
TR-28-001-25

Lobe Grasping Forceps



24,5 cm
TR-28-011-24



22,0 cm
TR-28-012-22

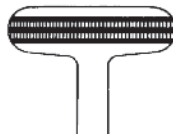

23,5 cm
TR-28-013-23

Ligature Carrying Forceps

Lobe Grasping Forceps

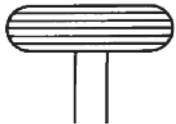

24,0 cm
TR-28-014-24

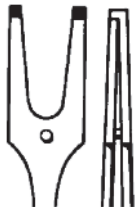

24,5 cm
TR-28-015-24



Millin

Genito-Urinary Instruments

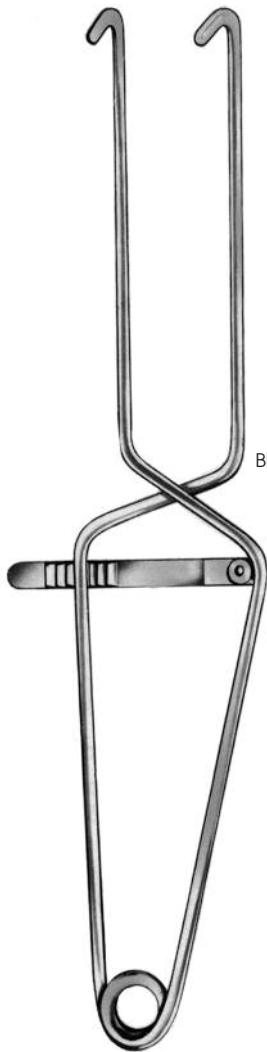

Bladder Neck Spreader

Millin

28,0 cm **TR-28-020-00**

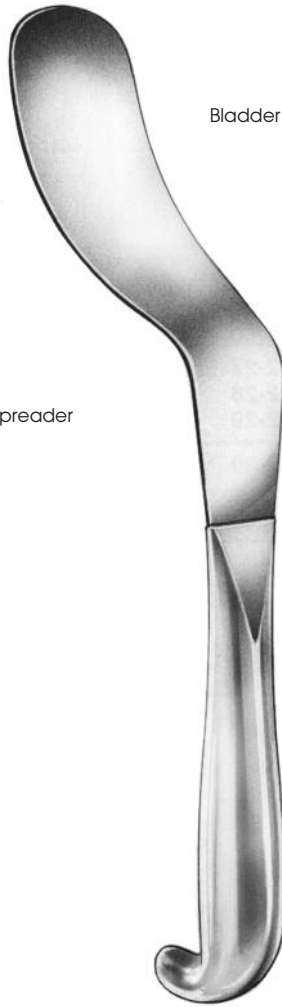

Bladder Spatula

Legueu

27,0 cm **TR-28-021-27**



Stockmann

8,0 cm **TR-28-050-08**

Penis Seizing Forceps



Strauss

13,0 cm **TR-28-052-13**

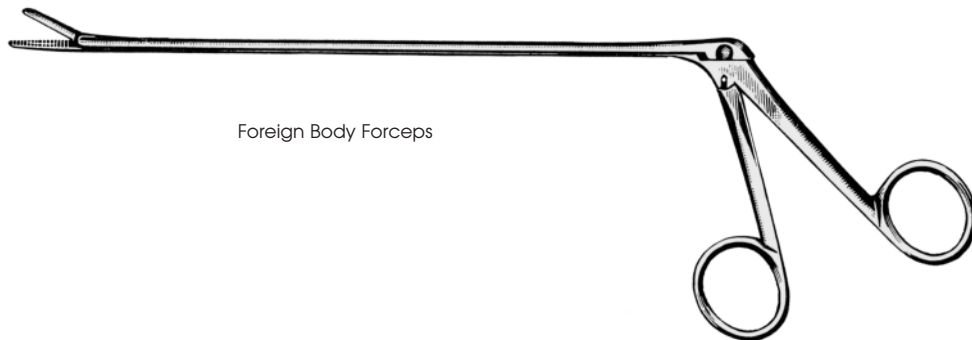

Foreign Body Forceps

Mathieu

19,0 cm **TR-28-080-19**

28,0 cm **TR-28-080-28**

Guyon Urethral Bougies

Set of 21 bougies in case (Fig. 10-30)

TR-28-100-00



Maßtabelle Metall Bougies, 25,5 cm
Table of measurements

Charrière	Art.-Nr.
8	TR-28-100-08
9	TR-28-100-09
10	TR-28-100-10
11	TR-28-100-11
12	TR-28-100-12
13	TR-28-100-13
14	TR-28-100-14
15	TR-28-100-15
16	TR-28-100-16
17	TR-28-100-17
18	TR-28-100-18
19	TR-28-100-19
20	TR-28-100-20
21	TR-28-100-21
22	TR-28-100-22
23	TR-28-100-23
24	TR-28-100-24
25	TR-28-100-25
26	TR-28-100-26
27	TR-28-100-27
28	TR-28-100-28
29	TR-28-100-29
30	TR-28-100-30

Dilating Bougies

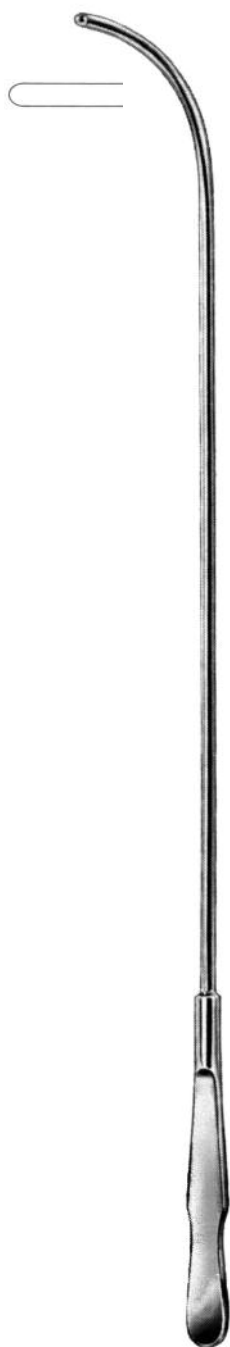

Dittel, 34,5 cm

Maßtabelle Metall Bougies, 34,5 cm
Table of measurements

Charrière	Art.-Nr.
8	TR-28-102-08
9	TR-28-102-09
10	TR-28-102-10
11	TR-28-102-11
12	TR-28-102-12
13	TR-28-102-13
14	TR-28-102-14
15	TR-28-102-15
16	TR-28-102-16
17	TR-28-102-17
18	TR-28-102-18
19	TR-28-102-19
20	TR-28-102-20
21	TR-28-102-21
22	TR-28-102-22
23	TR-28-102-23
24	TR-28-102-24
25	TR-28-102-25
26	TR-28-102-26
27	TR-28-102-27
28	TR-28-102-28
29	TR-28-102-29
30	TR-28-102-30
32	TR-28-102-32
34	TR-28-102-34
36	TR-28-102-36



Dittel, 19,0 cm

Maßtabelle Metall Bougies, Größe 19,5 cm
Table of measurements

Charrière	Art.-Nr.
8	TR-28-104-08
9	TR-28-104-09
10	TR-28-104-10
11	TR-28-104-11
12	TR-28-104-12
13	TR-28-104-13
14	TR-28-104-14
15	TR-28-104-15
16	TR-28-104-16
17	TR-28-104-17
18	TR-28-104-18
19	TR-28-104-19
20	TR-28-104-20
21	TR-28-104-21
22	TR-28-104-22
23	TR-28-104-23
24	TR-28-104-24
25	TR-28-104-25
26	TR-28-104-26
27	TR-28-104-27
28	TR-28-104-28
29	TR-28-104-29
30	TR-28-104-30

Metal Catheters

Table of measurements
Female Catheters, metal, 15,0 cm

Charrière	Art.-Nr.
6	TR-28-110-06
7	TR-28-110-07
8	TR-28-110-08
9	TR-28-110-09
10	TR-28-110-10
11	TR-28-110-11
12	TR-28-110-12
14	TR-28-110-14
16	TR-28-110-16
18	TR-28-110-18
20	TR-28-110-20
22	TR-28-110-22
24	TR-28-110-24

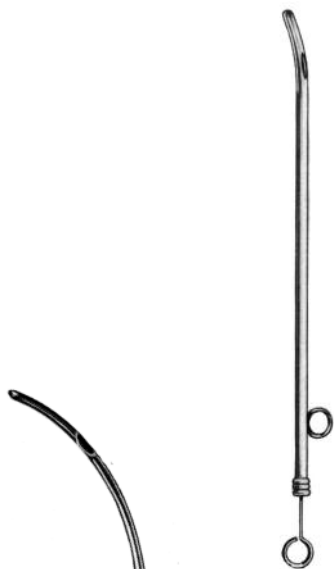
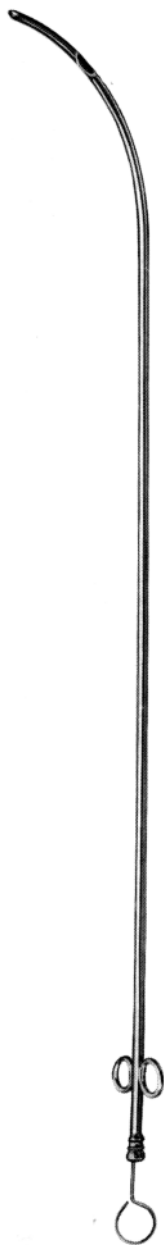
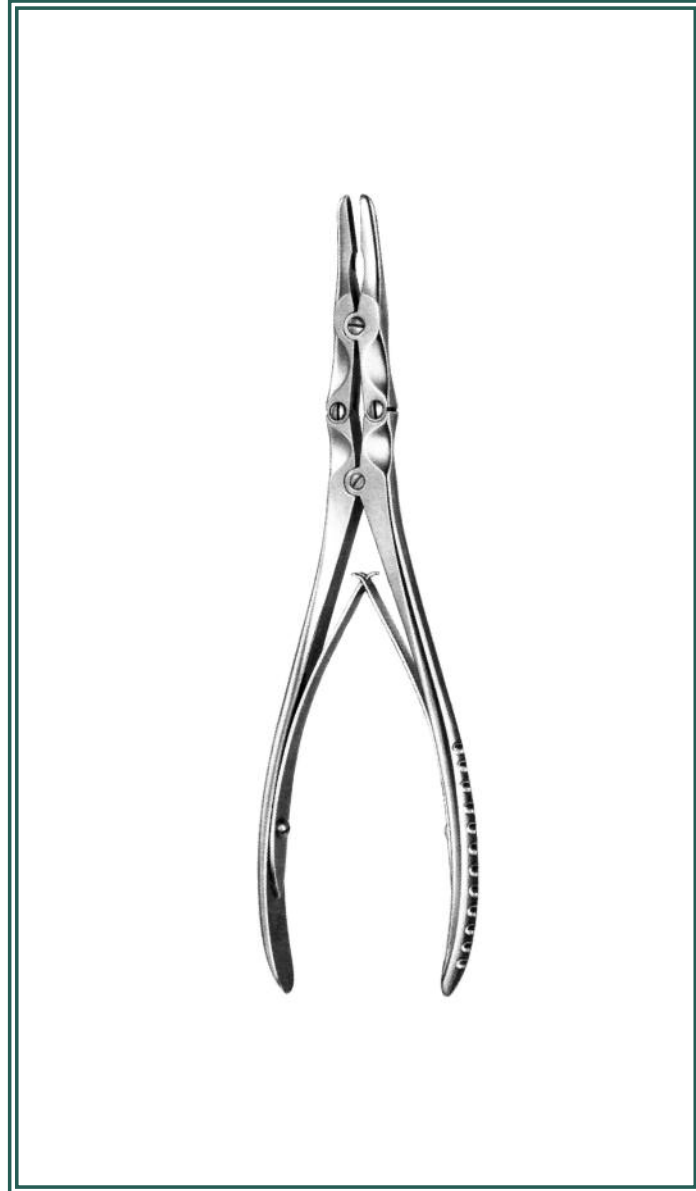

Table of measurements
Male Catheters, metal, 29,5 cm

Charrière	Art.-Nr.
8	TR-28-112-08
10	TR-28-112-10
12	TR-28-112-12
14	TR-28-112-14
16	TR-28-112-16
18	TR-28-112-18
20	TR-28-112-20



Catheter introducer
36,0 cm **TR-28-115-02**



18
Bone Surgery

Punches



Citelli

- ∅ 1,0 mm **TR-31-000-10**
- ∩ 2,0 mm **TR-31-000-20**
- ∪ 3,5 mm **TR-31-000-35**

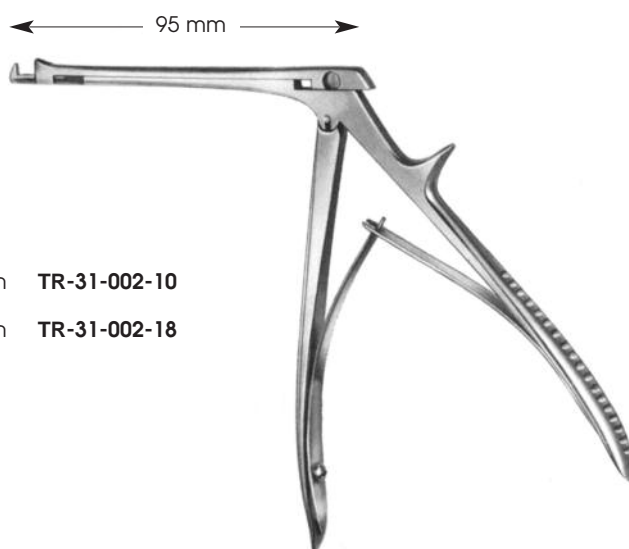





Citelli-Beyer

- ∅ 1,0 mm **TR-31-002-10**
- ∩ 1,8 mm **TR-31-002-18**

← 95 mm →



-  3,0 mm **TR-31-004-03**
-  4,0 mm **TR-31-004-04**
-  5,0 mm **TR-31-004-05**
-  6,0 mm **TR-31-004-06**

Kerrison

← 140 mm →

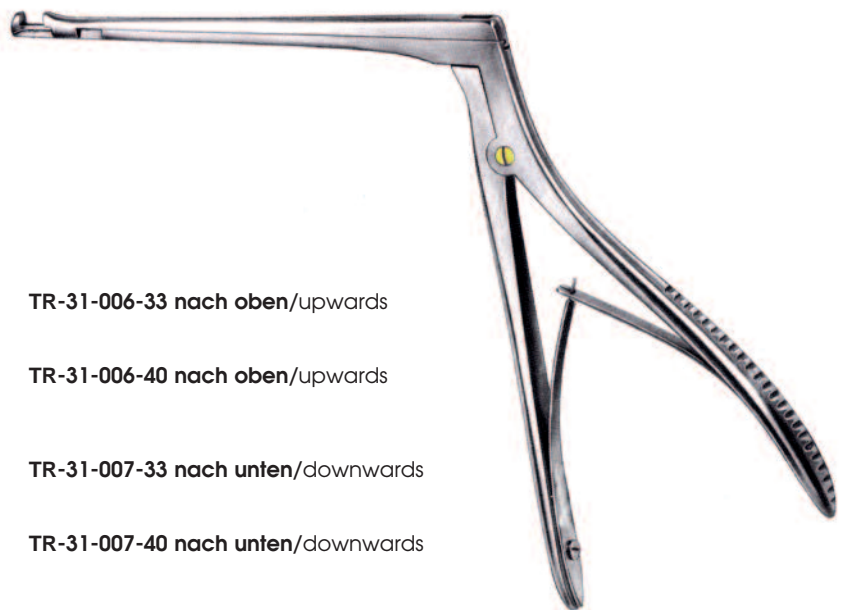

-  3,3 mm **TR-31-006-33 nach oben/upwards**
-  4,0 mm **TR-31-006-40 nach oben/upwards**
-  3,3 mm **TR-31-007-33 nach unten/downwards**
-  4,0 mm **TR-31-007-40 nach unten/downwards**

Kerrison

Punches



Ferris-Smith-Kerrison

item no.	length of shaft	bite	item no.	length of shaft	bite
TR-31-014-01	180 mm	1,0 mm	TR-31-016-01	180 mm	1,0 mm
TR-31-014-02	180 mm	2,0 mm	TR-31-016-02	180 mm	2,0 mm
TR-31-014-03	180 mm	3,0 mm	TR-31-016-03	180 mm	3,0 mm
TR-31-014-04	180 mm	4,0 mm	TR-31-016-04	180 mm	4,0 mm
TR-31-014-05	180 mm	5,0 mm	TR-31-016-05	180 mm	5,0 mm
TR-31-014-06	180 mm	6,0 mm	TR-31-016-06	180 mm	6,0 mm
TR-31-014-13	200 mm	3,0 mm			
TR-31-014-14	200 mm	4,0 mm			
TR-31-014-15	200 mm	5,0 mm			
TR-31-014-16	200 mm	6,0 mm			
TR-31-014-22	230 mm	2,0 mm	TR-31-016-22	230 mm	2,0 mm
TR-31-014-23	230 mm	3,0 mm	TR-31-016-23	230 mm	3,0 mm
TR-31-014-24	230 mm	4,0 mm	TR-31-016-24	230 mm	4,0 mm
TR-31-014-25	230 mm	5,0 mm	TR-31-016-25	230 mm	5,0 mm

Punches, detachable and with thin footplate, available on request.

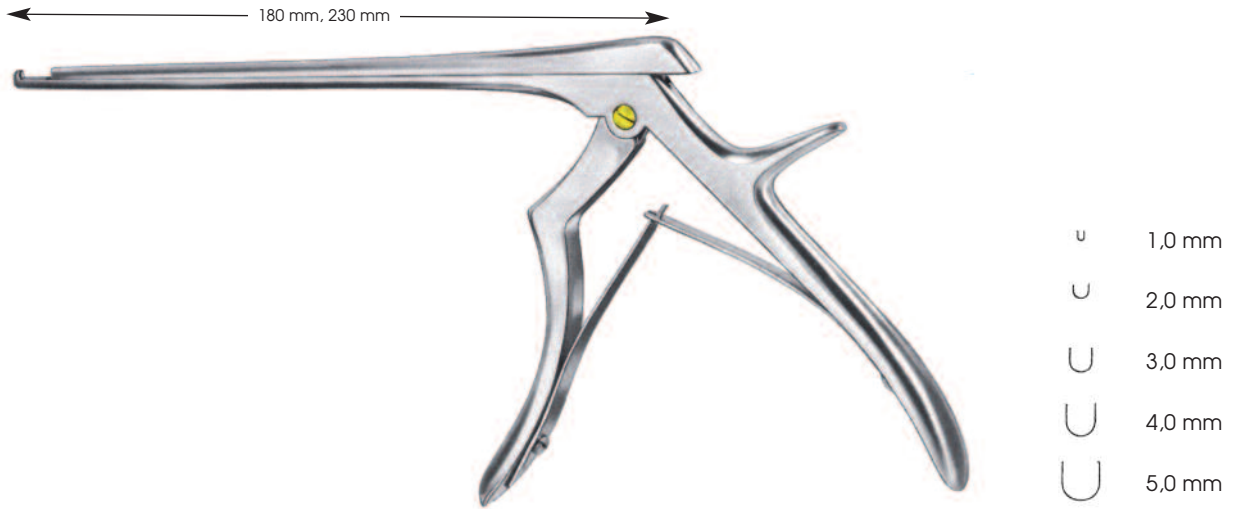

Ferris-Smith-Kerrison

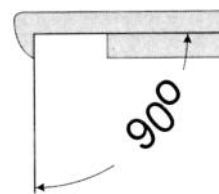
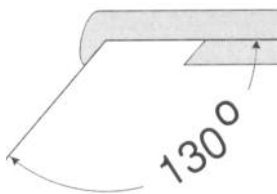

item no.	length of shaft	bite
TR-31-017-01	180 mm	1,0 mm
TR-31-017-02	180 mm	2,0 mm
TR-31-017-03	180 mm	3,0 mm
TR-31-017-04	180 mm	4,0 mm
TR-31-017-05	180 mm	5,0 mm
TR-31-017-22	230 mm	2,0 mm
TR-31-017-23	230 mm	3,0 mm
TR-31-017-24	230 mm	4,0 mm
TR-31-017-25	230 mm	5,0 mm

item no.	length of shaft	bite
TR-31-019-01	180 mm	1,0 mm
TR-31-019-02	180 mm	2,0 mm
TR-31-019-03	180 mm	3,0 mm
TR-31-019-04	180 mm	4,0 mm
TR-31-019-05	180 mm	5,0 mm
TR-31-019-22	230 mm	2,0 mm
TR-31-019-23	230 mm	3,0 mm
TR-31-019-24	230 mm	4,0 mm
TR-31-019-25	230 mm	5,0 mm

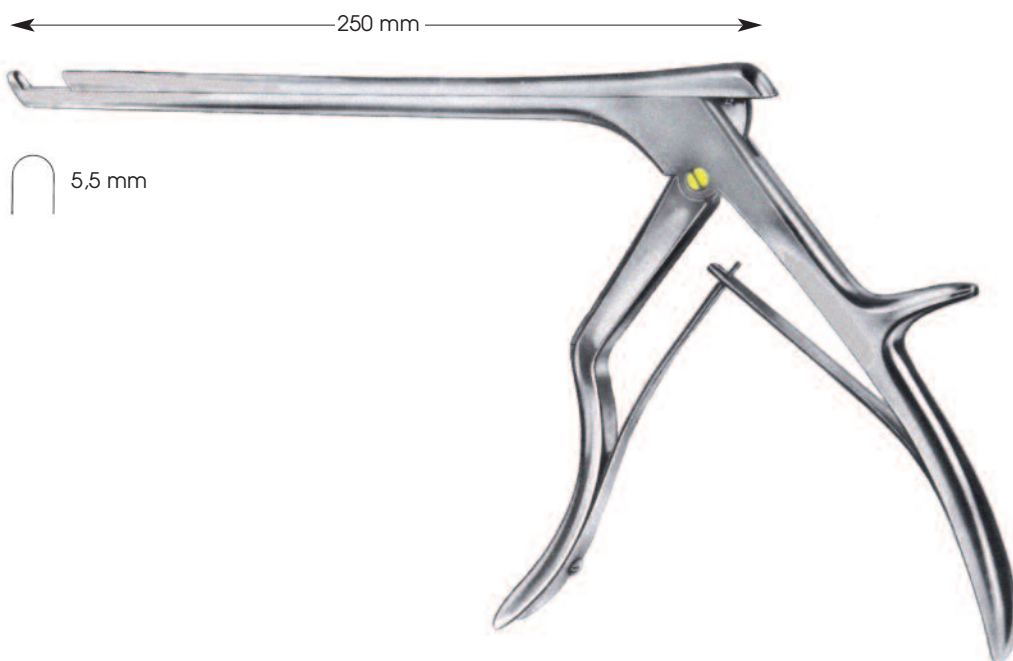

Punches, detachable and with thin footplate, available on request.

Punches

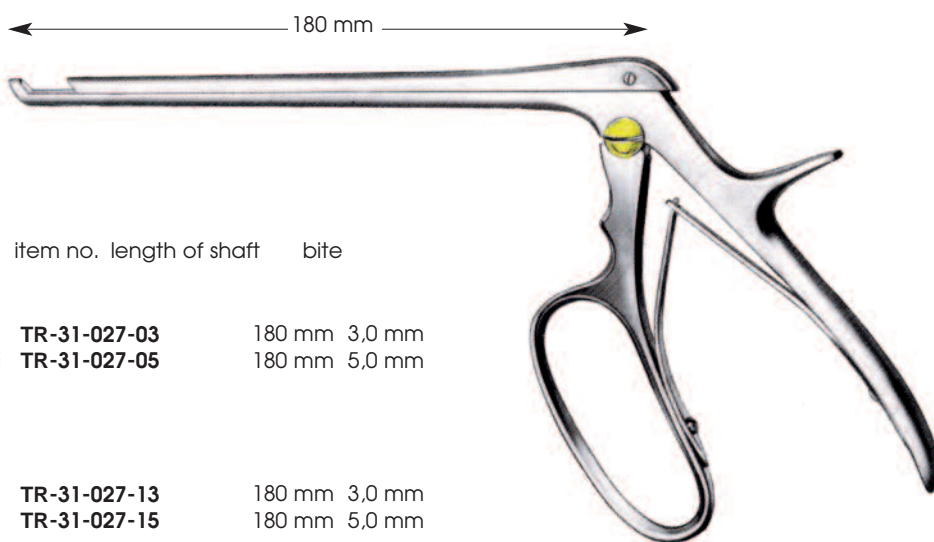

Syper
130°, 5,5 mm **31-026-55**



item no.	length of shaft	bite
 TR-31-027-03	180 mm	3,0 mm
TR-31-027-05	180 mm	5,0 mm
 TR-31-027-13	180 mm	3,0 mm
TR-31-027-15	180 mm	5,0 mm
 TR-31-027-23	180 mm	3,0 mm
TR-31-027-25	180 mm	5,0 mm

Ferris-Smith-Kerrison

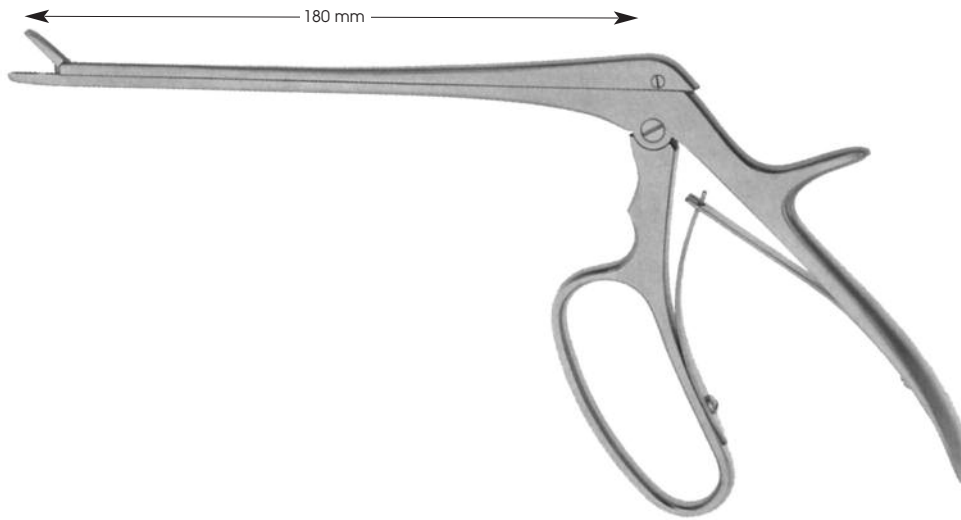

Ferris-Smith-Cushing

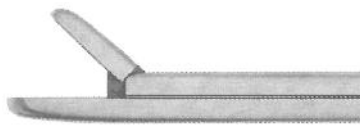

straight

- TR-31-028-02** 2 x 10 mm
- TR-31-028-03** 3 x 10 mm
- TR-31-028-04** 4 x 10 mm
- TR-31-028-05** 5 x 10 mm
- TR-31-028-06** 6 x 10 mm

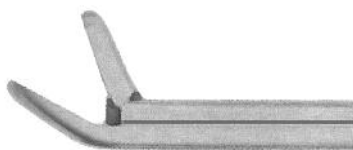

curved on flat

- TR-31-028-12** 2 x 10 mm
- TR-31-028-13** 3 x 10 mm
- TR-31-028-14** 4 x 10 mm

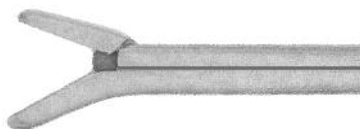

curved down

- TR-31-028-22** 2 x 10 mm
- TR-31-028-23** 3 x 10 mm
- TR-31-028-24** 4 x 10 mm

Nasal Forceps

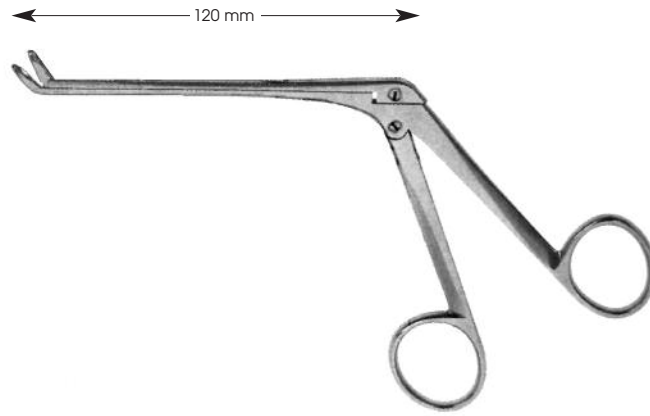

Weil-Blakesley



3,0 mm



3,6 mm



4,2 mm



4,8 mm



5,8 mm



straight

TR-31-036-30

TR-31-036-36

TR-31-036-42

TR-31-036-48

TR-31-036-58



45°

TR-31-037-31

TR-31-037-36

TR-31-037-42

TR-31-037-48

TR-31-037-58



90°

TR-31-037-66

TR-31-037-72

TR-31-037-78

Nasal Forceps, Tonsil Forceps



Myles

 2,0 mm **TR-31-038-02**

 3,0 mm **TR-31-038-03**

 4,0 mm **TR-31-038-04**



Hajek

 2,5 mm **TR-31-039-25**

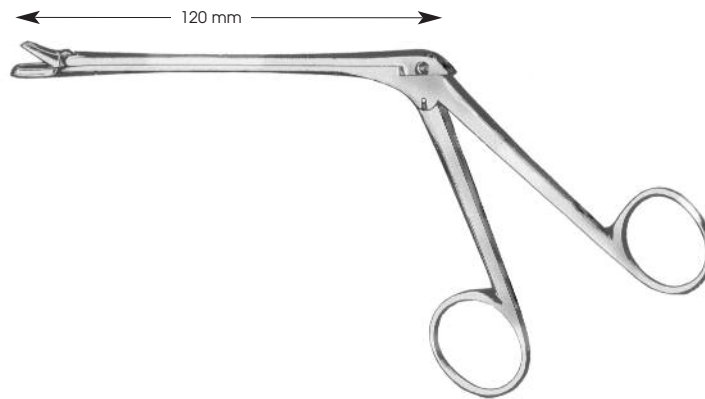



Hartmann

 5,0 mm **TR-31-040-05**

 7,0 mm **TR-31-040-07**

 9,0 mm **TR-31-040-09**

 11,0 mm **TR-31-040-11**

 13,0 mm **TR-31-040-13**

 15,0 mm **TR-31-040-15**

 17,0 mm **TR-31-040-17**



Schmeden

 5,0 mm **TR-31-041-12**

 7,0 mm **TR-31-041-13**

Nasal Forceps

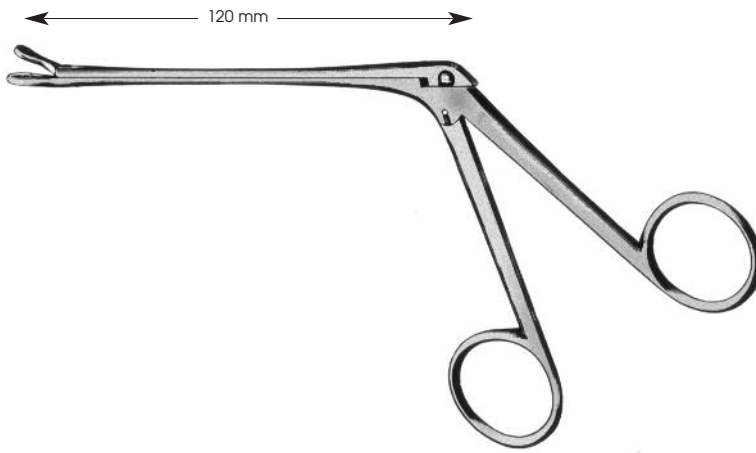

Watson-Williams
TR-31-042-01



Weil
TR-31-042-02

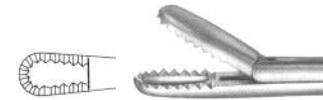

Watson-Williams
TR-31-042-03



TR-31-044-03



TR-31-045-03

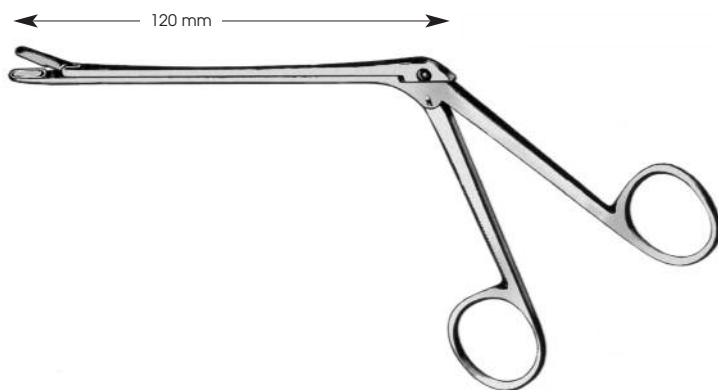

Takahashi

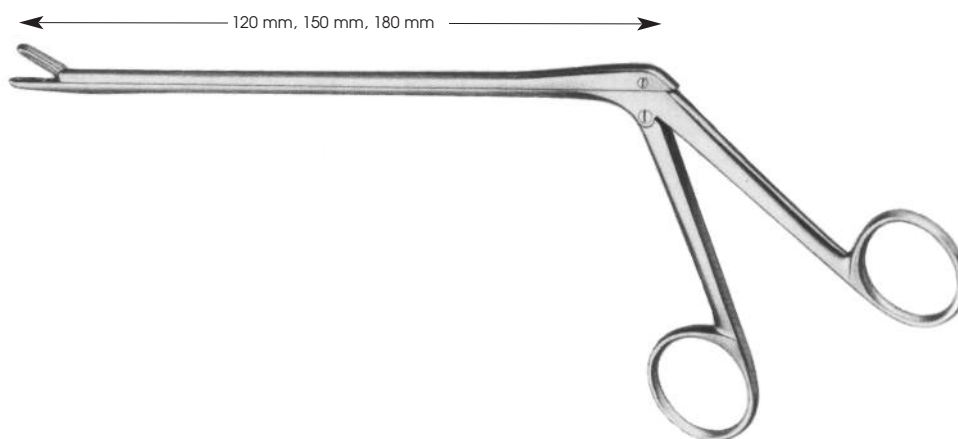

tem-no.	description	size of jaws	length of shaft
TR-31-046-02	Cushing	2 x 10 mm	120 mm
TR-31-050-02	Cushing	2 x 10 mm	150 mm
TR-31-066-02	Cushing	2 x 10 mm	180 mm
TR-31-046-03	Love Grünwald	3 x 10 mm	120 mm
TR-31-050-03	Love Grünwald	3 x 10 mm	150 mm
TR-31-066-03	Love Grünwald	3 x 10 mm	180 mm
TR-31-046-04	Spurling	4 x 10 mm	120 mm
TR-31-050-04	Spurling	4 x 10 mm	150 mm
TR-31-066-04	Spurling	4 x 10 mm	180 mm



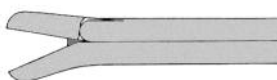

TR-31-047-02	Cushing	2 x 10 mm	120 mm
TR-31-051-02	Cushing	2 x 10 mm	150 mm
TR-31-067-02	Cushing	2 x 10 mm	180 mm
TR-31-047-03	Love Grünwald	3 x 10 mm	120 mm
TR-31-051-03	Love Grünwald	3 x 10 mm	150 mm
TR-31-067-03	Love Grünwald	3 x 10 mm	180 mm
TR-31-047-04	Spurling	4 x 10 mm	120 mm
TR-31-051-04	Spurling	4 x 10 mm	150 mm
TR-31-067-04	Spurling	4 x 10 mm	180 mm



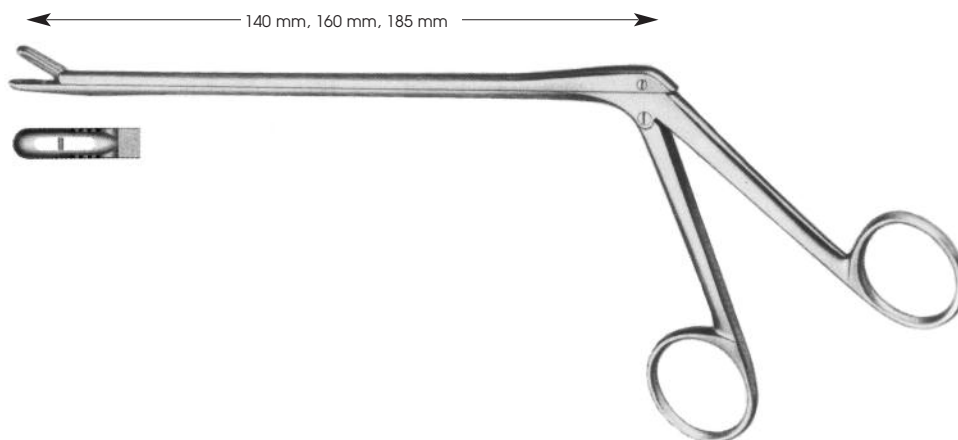

TR-31-049-02	Cushing	2 x 10 mm	120 mm
TR-31-053-02	Cushing	2 x 10 mm	150 mm
TR-31-069-02	Cushing	2 x 10 mm	180 mm
TR-31-049-03	Love Grünwald	3 x 10 mm	120 mm
TR-31-053-03	Love Grünwald	3 x 10 mm	150 mm
TR-31-069-03	Love Grünwald	3 x 10 mm	180 mm
TR-31-049-04	Spurling	4 x 10 mm	120 mm
TR-31-053-04	Spurling	4 x 10 mm	150 mm
TR-31-069-04	Spurling	4 x 10 mm	180 mm

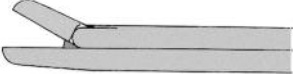
Laminectomy Rongeurs

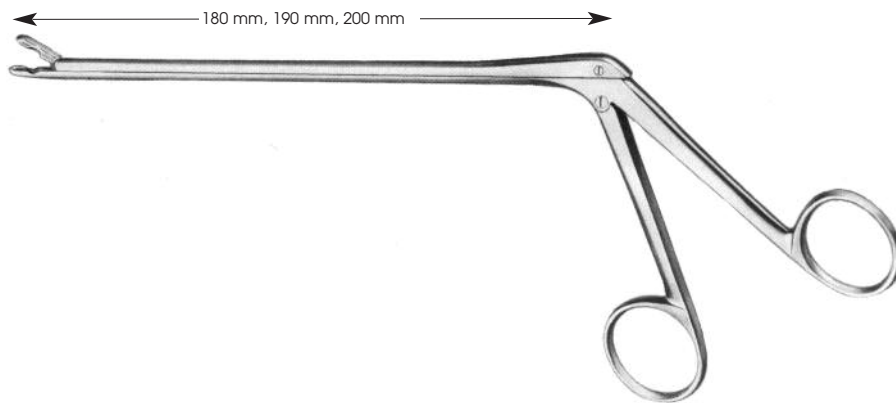

	item-no.	description	size of jaws	length of shaft
	TR-31-054-02	Caspar	2 x 12 mm	140 mm
	TR-31-056-02	Caspar	2 x 12 mm	160 mm
	TR-31-058-02	Caspar	2 x 12mm	185 mm
	TR-31-054-03	Caspar	3 x 13 mm	140 mm
	TR-31-056-03	Caspar	3 x 13 mm	160 mm
	TR-31-058-03	Caspar	3 x 13 mm	185 mm
	TR-31-054-04	Caspar	4 x 14 mm	140 mm
	TR-31-056-04	Caspar	4 x 14 mm	160 mm
	TR-31-058-04	Caspar	4 x 14 mm	185 mm
	TR-31-054-05	Caspar	5 x 14 mm	140 mm
	TR-31-056-05	Caspar	5 x 14 mm	160 mm
	TR-31-058-05	Caspar	5 x 14 mm	185 mm
	TR-31-054-06	Caspar	6 x 16 mm	140 mm
	TR-31-056-06	Caspar	6 x 16 mm	160 mm
	TR-31-058-06	Caspar	6 x 16 mm	185 mm
	TR-31-055-03	Caspar	3 x 13 mm	140 mm
	TR-31-057-03	Caspar	3 x 13 mm	160 mm
	TR-31-059-03	Caspar	3 x 13 mm	185 mm
	TR-31-055-04	Caspar	4 x 14 mm	140 mm
	TR-31-057-04	Caspar	4 x 14 mm	160 mm
	TR-31-059-04	Caspar	4 x 14 mm	185 mm
	TR-31-055-05	Caspar	5 x 14 mm	140 mm
	TR-31-057-05	Caspar	5 x 14 mm	160 mm
	TR-31-059-05	Caspar	5 x 14 mm	185 mm
	TR-31-061-03	Caspar	3 x 13 mm	140 mm
	TR-31-063-03	Caspar	3 x 13 mm	160 mm
	TR-31-065-03	Caspar	3 x 13 mm	185 mm
	TR-31-061-04	Caspar	4 x 14 mm	140 mm
	TR-31-063-04	Caspar	4 x 14 mm	160 mm
	TR-31-065-04	Caspar	4 x 14 mm	185 mm



 **Oldberg**
18,0 cm Ø 7,0 mm **TR-31-072-07**

 **Landolt**
20,0 cm Ø 9,0 mm **TR-31-074-09**

 **Yasargil**
19,0 cm Ø 2,2 mm **TR-31-076-22**

 **Yasargil**
19,0 cm Ø 3,5 mm **TR-31-076-35**

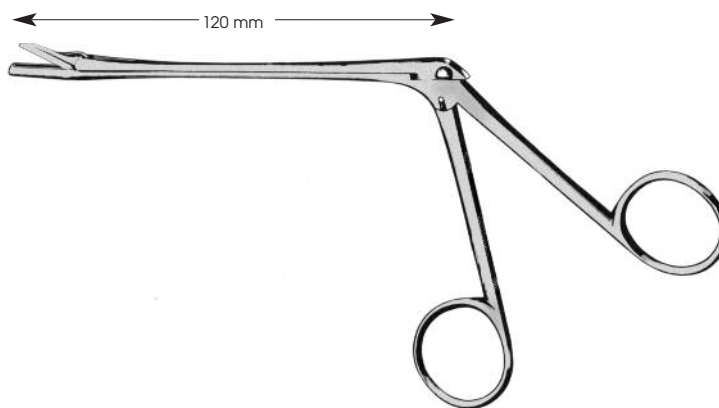

Struycken, 12,0 cm



TR-31-078-10

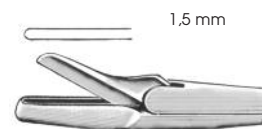

TR-31-078-15

Amputation

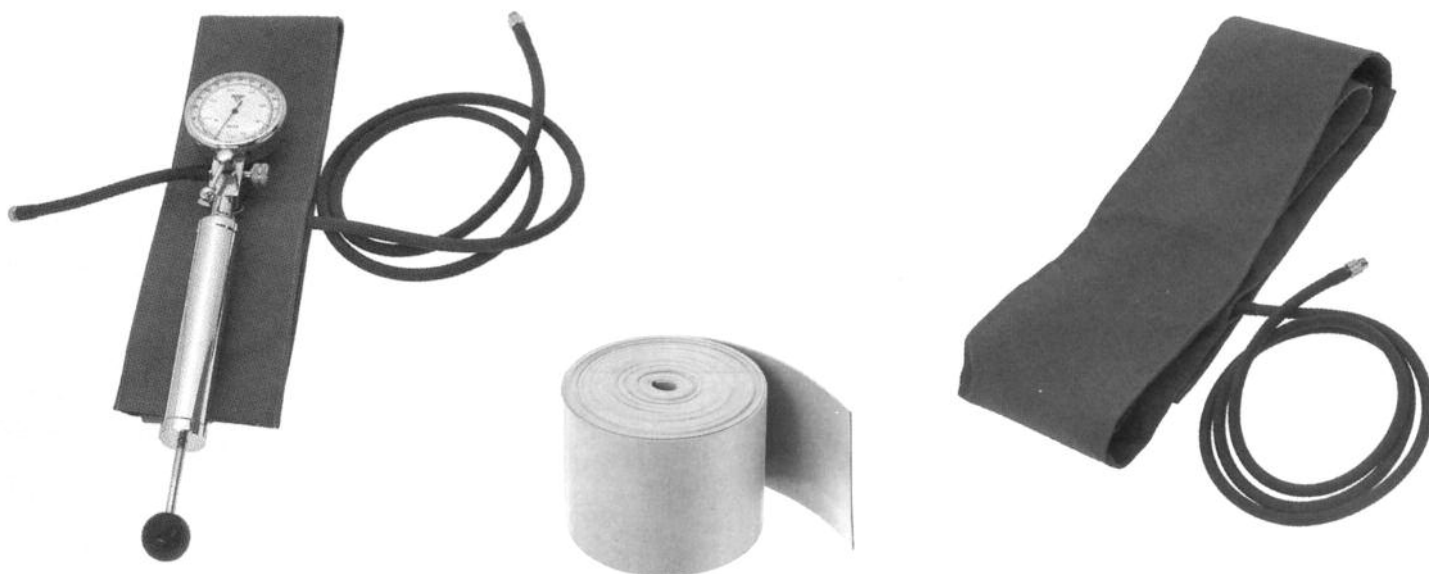

TR-31-110-00 High precision instrument for causing lack of blood in the limbs. complete consisting of:

Manometer with diaphragm, scale graduated to 700 mmHg,
Resistant pump.
1 each upper arm and upper thigh cuff

TR-31-110-02 Pump with manometer

TR-31-110-03 Cuff for the leg

TR-31-110-04 Cuff for the lower arm

TR-31-110-10 Compression bandage , 5m

TR-31-110-14 Cuff for the upper arm



Langenbeck
TR-31-114-55

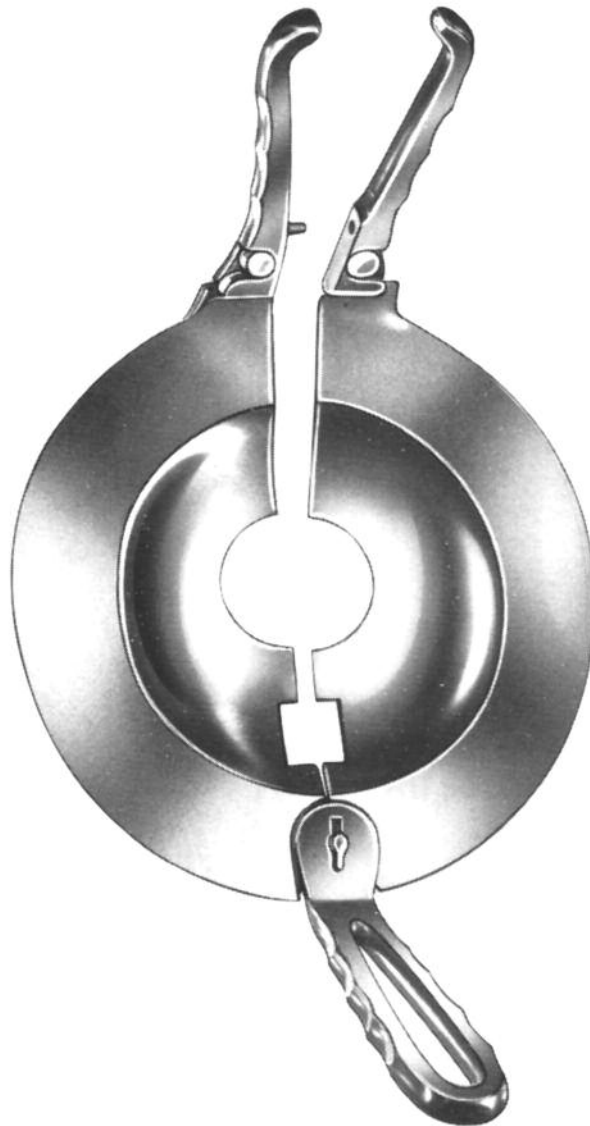

Handles detachable

Percy
TR-31-117-01

Amputation

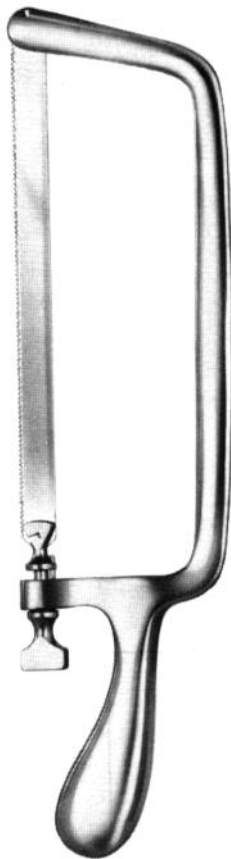

Charrière
35,0 cm **TR-31-120-00**

Spare saw blades

12,0 mm **TR-31-120-12**
15,0 mm **TR-31-120-15**
18,0 mm **TR-31-120-18**

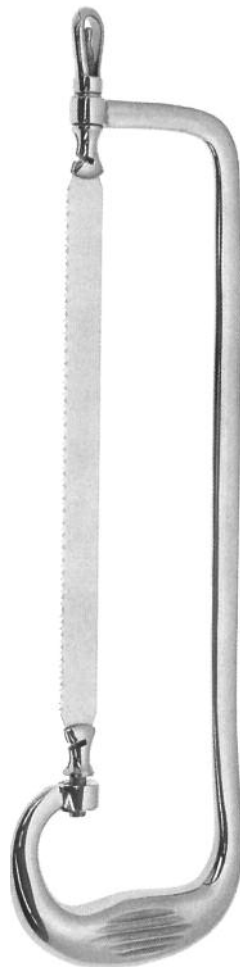

Rust
39,0 cm **TR-31-121-00**

Spare saw blades

6,0 mm **TR-31-121-06**
8,0 mm **TR-31-121-08**
15,0 mm **TR-31-121-15**
20,0 mm **TR-31-121-20**



Helferich-Bier
42,0 cm **TR-31-122-00**

Spare saw blades

4,0 mm **TR-31-122-04**
6,0 mm **TR-31-122-06**
8,0 mm **TR-31-122-08**

Amputation

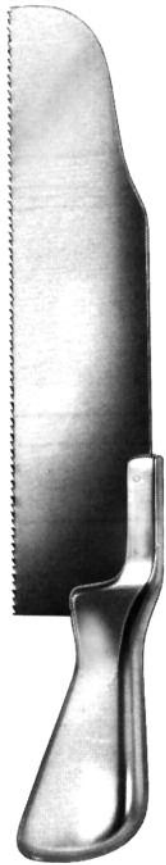

27,0 cm **Charrière**
TR-31-124-00, Blade 180 mm

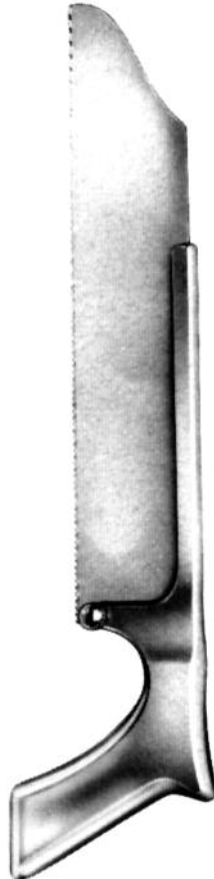

29,0 cm **Satterlee**
TR-31-126-00, Blade 200 mm



23,0 cm **Langenbeck**
TR-31-128-00, Blade 115 mm

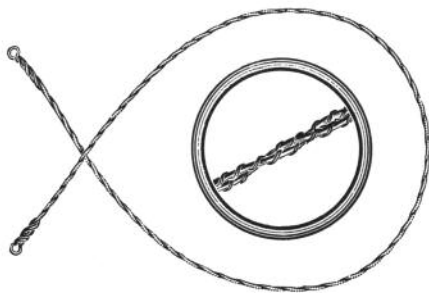

Olivecrona
30,0 cm TR-31-130-30
40,0 cm TR-31-130-40
50,0 cm TR-31-130-50
60,0 cm TR-31-130-60
70,0 cm TR-31-130-70



Gigli
Handle for wire saws
TR-31-135-00

Amputation



Finger Ring Saw
17,0 cm **TR-31-137-00**
Saw blade
TR-31-137-01



Finger Ring Saw
17,0 cm **TR-31-139-00**
Saw blade
TR-31-139-01



Riemer, 4-edge
14,0 cm **TR-31-150-14**

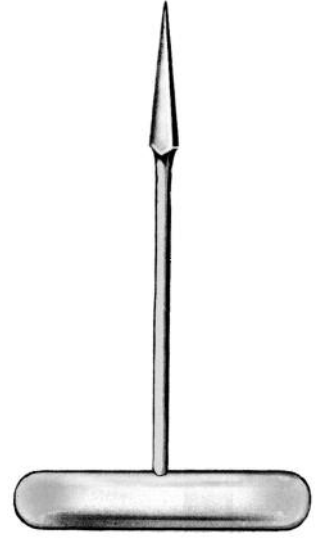

Riemer, 4-edge
14,0 cm **TR-31-152-14**

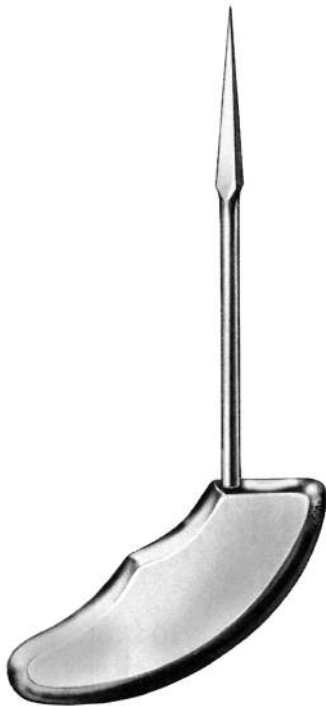

Perthes
Riemer
18,0 cm **TR-31-154-18**

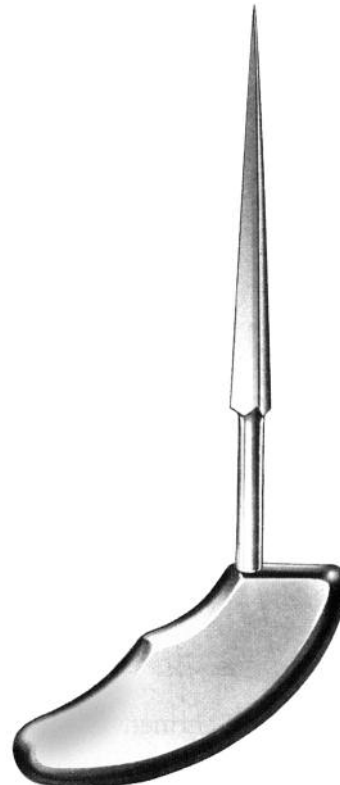

Perthes
Riemer
21,0 cm **TR-31-156-21**

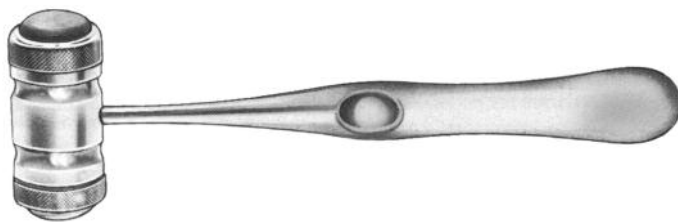

Mead
18,0 cm, Ø 20 mm, 185 g
TR-31-200-20

Spare jaws, pair
TR-31-200-22



18,5 cm, Ø 25 mm, 140 g
TR-31-201-25

Spare jaws, pair
TR-31-201-27

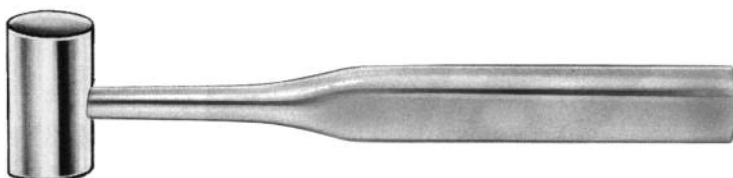

Cottle
19,0 cm, Ø 30 mm, 240 g
TR-31-202-30

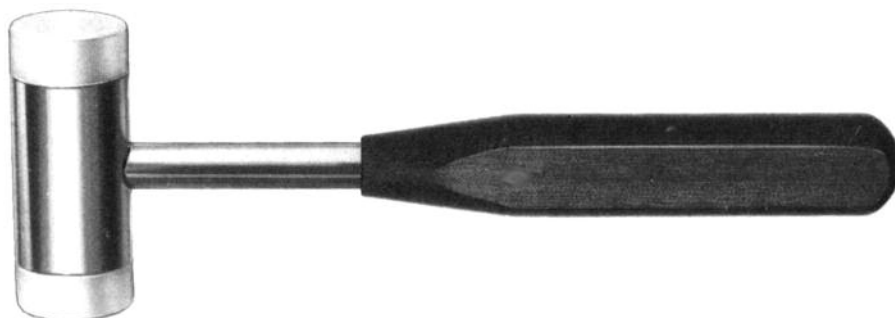

24,5 cm, Ø 30 mm, 215 g
TR-31-206-30

plastic disks
TR-31-206-32



Ferrozell
25,0 cm, Ø 35 mm **TR-31-210-35**
25,0 cm, Ø 42 mm **TR-31-210-42**
25,0 cm, Ø 50 mm **TR-31-210-50**

lead filled
25,0 cm, Ø 42 mm, 400 g
TR-31-224-42



24,0 cm, Ø 32/42 mm, 400 g
TR-31-212-42

26,0 cm, Ø 30/42 mm, 530 g
TR-31-228-42

Mallets

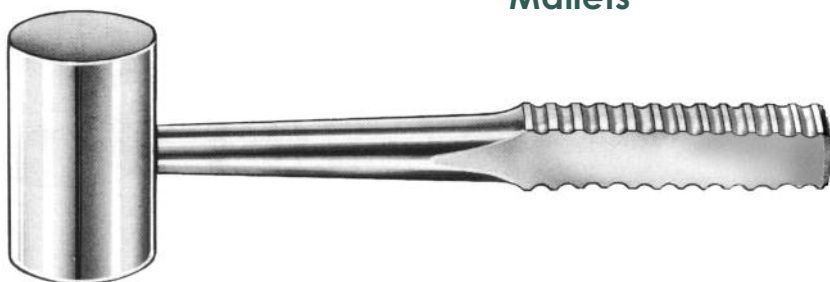

Heath
18,5 cm, Ø 40 mm, 700 g
TR-31-214-40

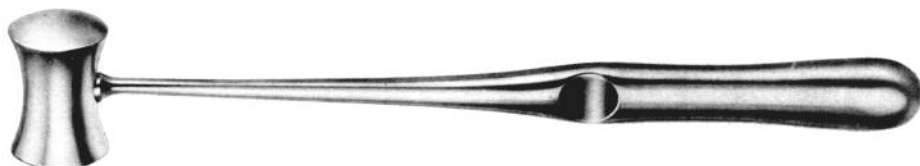

Williger
24,0 cm, Ø 26 mm, 300 g **TR-31-215-26**
24,0 cm, Ø 28 mm, 340 g **TR-31-215-28**
24,0 cm, Ø 30 mm, 400 g **TR-31-215-30**



DOYEN
21,0 cm, Ø 25 mm, 120 g **TR-31-216-25**
21,0 cm, Ø 30 mm, 180 g **TR-31-216-30**
21,0 cm, Ø 35 mm, 260 g **TR-31-216-35**

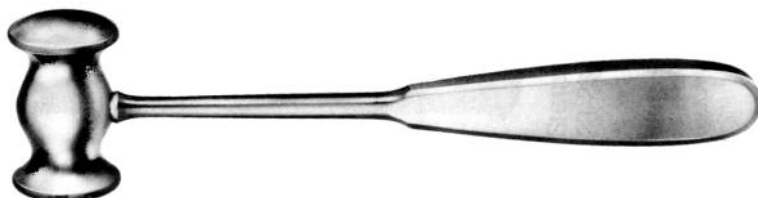

Collin
20,0 cm, Ø 30 mm, 220 g
TR-31-217-30

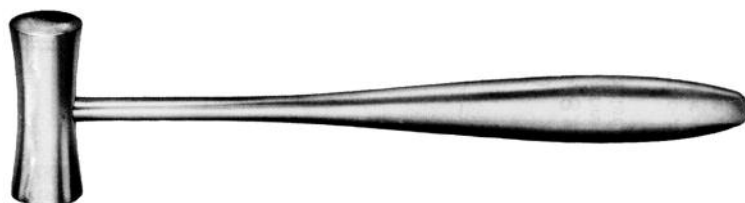

Lucae
lead filled
19,0 cm, Ø 19 mm, 230 g **TR-31-218-19**
25,0 cm, Ø 25 mm, 260 g **TR-31-218-25**

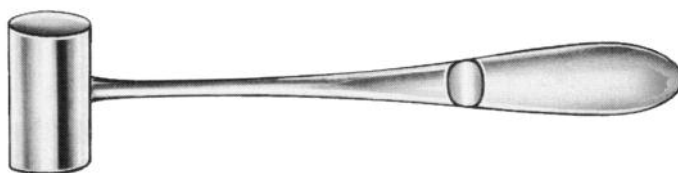

lead filled
16,5 cm, Ø 22 mm, 140 g
TR-31-219-20

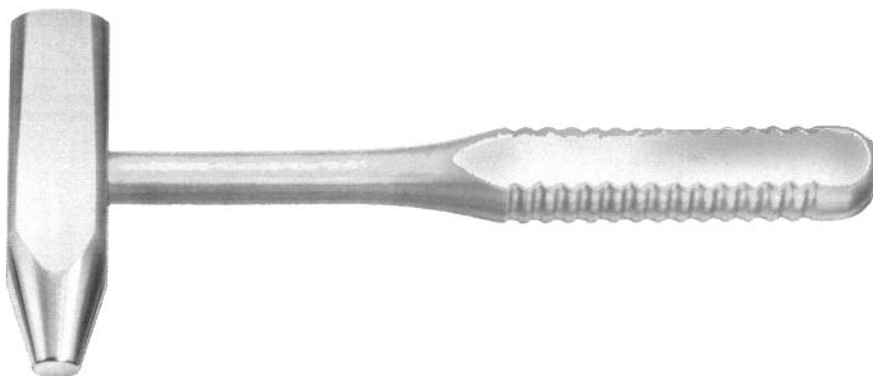

23,5 cm, 27 mm/Ø 13,5 mm
TR-31-220-27



26,0 cm, Ø 30 mm, 510 g
TR-31-221-30



Partsch
18,0 cm, Ø 22 mm
TR-31-222-22



Ferozell
lead filled
26,0 cm, Ø 42 mm, 400 g
TR-31-226-42



Ferozell
18,0 cm, Ø 30 mm, 125 g
TR-31-227-30



26,0 cm, Ø 32 mm, 675 g
repercussion free
TR-31-229-29

one side: Steel convex
one side: Nylon plane

Mallets



26,0 cm, Ø 30 mm, 450 g
TR-31-230-45



26,0 cm, Ø 50 mm, 900 g
TR-31-230-90



24,0 cm, Ø 30 mm, 480 g
TR-31-231-48



Handle and disks of plastic
24,0 cm, Ø 37 mm, 370 g
TR-31-232-37

Spare jaws, pair
TR-31-232-42

Bone Chisels and Gouges



□ 2,5 mm
TR-31-250-25
□ 3,5 mm
TR-31-250-35

Passow, 12,0 cm



● Ø 2 mm
TR-31-251-02 ● Ø 3 mm
TR-31-251-02
● Ø 4 mm
TR-31-251-04 ● Ø 5 mm
TR-31-251-05
● Ø 6 mm
TR-31-251-06 ● Ø 8 mm
TR-31-251-08
● Ø 10 mm
TR-31-251-10

Stöbel, 15,5 cm



Freer, 4 mm
16,0 cm **TR-31-254-04**



Freer, 4 mm
16,0 cm **TR-31-255-04**



4 mm **TR-31-262-04** 6 mm **TR-31-262-06** 8 mm **TR-31-262-08**
10 mm **TR-31-262-10** 12 mm **TR-31-262-12**
14 mm **TR-31-262-14** 16 mm **TR-31-262-16**

Osteotome
14,0 cm









4 mm **TR-31-263-04** 6 mm **TR-31-263-06** 8 mm **TR-31-263-08**
10 mm **TR-31-263-10** 12 mm **TR-31-263-12**
14 mm **TR-31-263-14** 16 mm **TR-31-263-16**

Chisel
14,0 cm





Bone Chisels and Gouges



		
4 mm TR-31-264-04	6 mm TR-31-264-06	8 mm TR-31-264-08
		
10 mm TR-31-264-10	12 mm TR-31-264-12	
		
10 mm TR-31-264-10	12 mm TR-31-264-12	





Hohlmeißel
Gouge
14,0 cm



		
2 mm TR-31-265-02 TR-31-266-02	3 mm TR-31-265-03 TR-31-266-03	4 mm TR-31-265-04 TR-31-266-04
		
5 mm TR-31-265-05 TR-31-266-05	6 mm TR-31-265-06 TR-31-266-06	







Partsc
Chisel



		
2 mm TR-31-267-02 TR-31-268-02	3 mm TR-31-267-03 TR-31-268-03	4 mm TR-31-267-04 TR-31-268-04
		
5 mm TR-31-267-05 TR-31-268-05	6 mm TR-31-267-06 TR-31-268-06	

Partsch
Gouge



		
4 mm TR-31-273-04	6 mm TR-31-273-06	8 mm TR-31-273-08
		
10 mm TR-31-273-10	12 mm TR-31-273-12	14 mm TR-31-273-14

Alexander
Chisel
18,0 cm

Bone Chisels and Gouges



Alexander
Gouge
18,0 cm

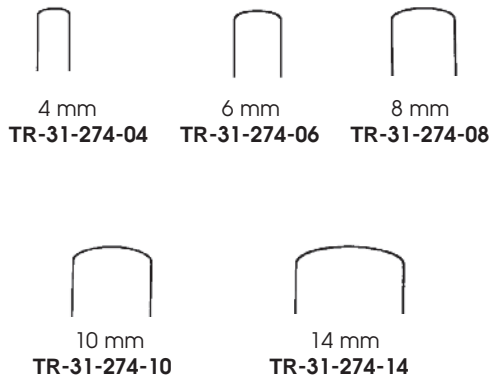

Mini-Lambotte
Osteotome

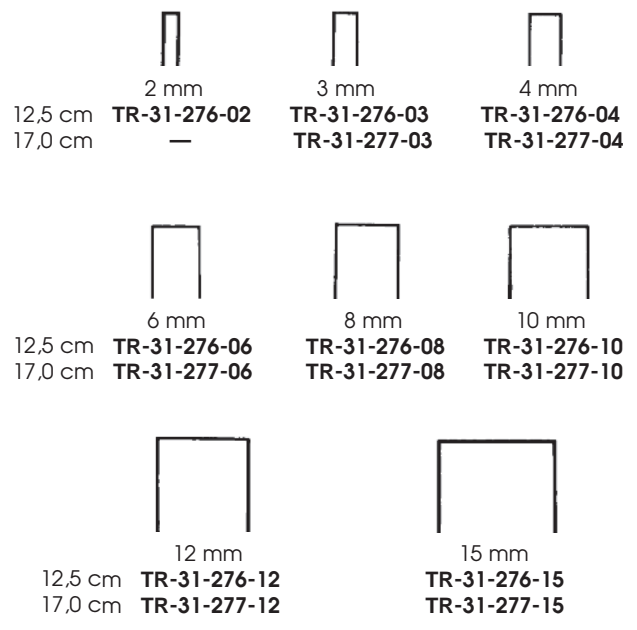

Cottle, 18,0 cm



Cottle, 18,0 cm

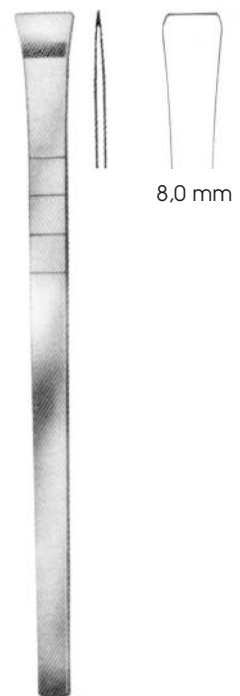

Fishtail Osteotome
18,0 cm **TR-31-280-08**

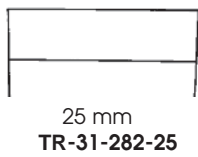
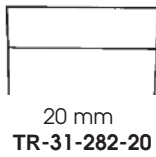
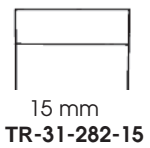
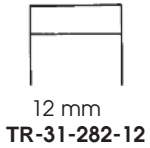
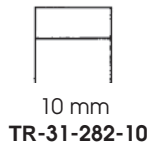
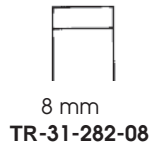

Stille
Chisel
20,0 cm



straight
curved
small

straight
curved
small

straight
curved
small

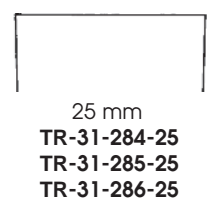
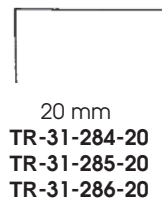
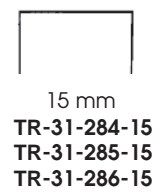
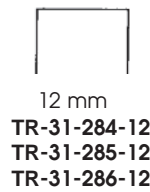
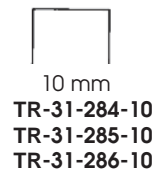
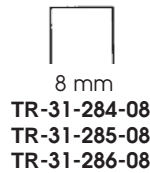

Stille
Osteotome
TR-31-284-08 - TR-31-286-25
20,0 cm

Bone Chisels and Gouges



Stille
Gouge
20,0 cm

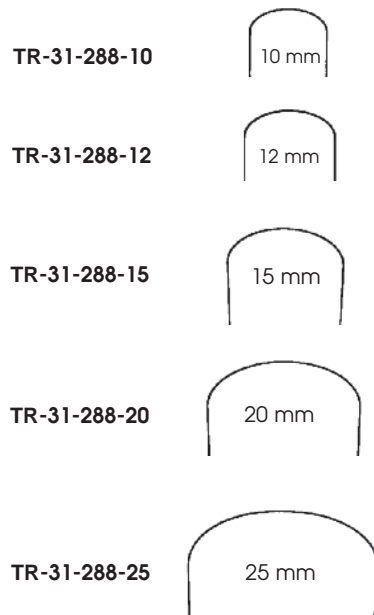

TR-31-288-10

10 mm

TR-31-288-12

12 mm

TR-31-288-15

15 mm

TR-31-288-20

20 mm

TR-31-288-25

25 mm

TR-31-289-10

TR-31-289-12

TR-31-289-15

TR-31-289-20

TR-31-289-25



- 4,0 mm TR-31-292-04
- 5,0 mm TR-31-292-05
- 6,0 mm TR-31-292-06
- 8,0 mm TR-31-292-08
- 10,0 mm TR-31-292-10
- 13,0 mm TR-31-292-13
- 15,0 mm TR-31-292-15
- 18,0 mm TR-31-292-18
- 20,0 mm TR-31-292-20
- 25,0 mm TR-31-292-25
- 30,0 mm TR-31-292-30
- 38,0 mm TR-31-292-38
- 44,0 mm TR-31-292-44
- 50,0 mm TR-31-292-50

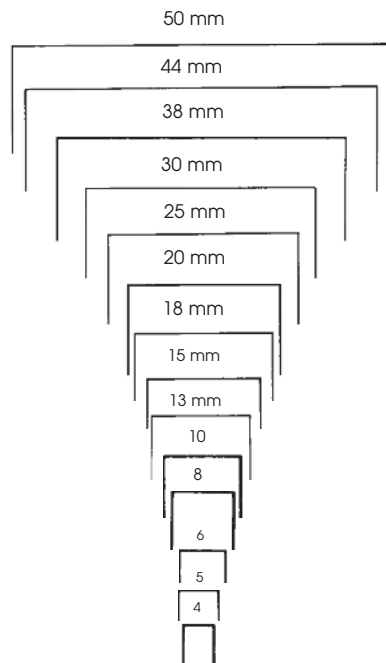

- 4,0 mm TR-31-293-04
- 5,0 mm TR-31-293-05
- 6,0 mm TR-31-293-06
- 8,0 mm TR-31-293-08
- 10,0 mm TR-31-293-10
- 13,0 mm TR-31-293-13
- 15,0 mm TR-31-293-15
- 18,0 mm TR-31-293-18
- 20,0 mm TR-31-293-20
- 25,0 mm TR-31-293-25
- 30,0 mm TR-31-293-30
- 38,0 mm TR-31-293-38
- 44,0 mm TR-31-293-44
- 50,0 mm TR-31-293-50

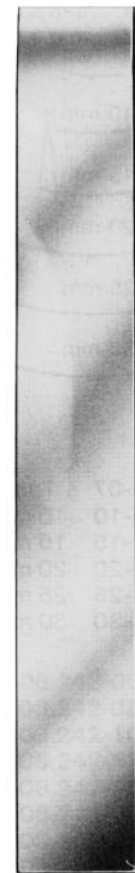

Lambotte
Osteotome
24,0 cm

Bone Chisels and Gouges



Hoke
Chisel
17,0 cm

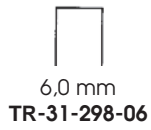
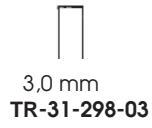

TR-31-300-06

TR-31-301-06

TR-31-302-06

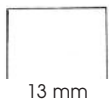

TR-31-300-13

TR-31-301-13

TR-31-302-13

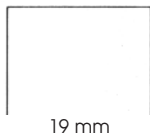

TR-31-300-19

TR-31-301-19

TR-31-302-19



TR-31-300-25

TR-31-301-25

TR-31-302-25



TR-31-300-32







TR-31-301-32

TR-31-302-32



Hibbs
Chisel
24,0 cm

Bone Chisels and Gouges

	6,0 mm	TR-31-303-06	TR-31-304-06	
	13,0 mm	TR-31-303-06	TR-31-304-06	
	19,0 mm	TR-31-303-06	TR-31-304-06	
	25,0 mm	TR-31-303-06	TR-31-304-06	
	32,0 mm	TR-31-303-06	TR-31-304-06	

Hibbs
Gouge
24,0 cm

Bone Chisels and Gouges



Smith-Petersen, 20,0 cm

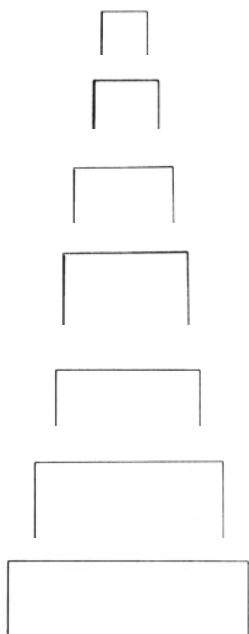

6,0 mm	TR-31-306-06	TR-31-307-06
9,0 mm	TR-31-306-09	TR-31-307-09
13,0 mm	TR-31-306-13	TR-31-307-13
16,0 mm	TR-31-306-16	TR-31-307-16
19,0 mm	TR-31-306-19	TR-31-307-19
25,0 mm	TR-31-306-25	TR-31-307-25
32,0 mm	TR-31-306-32	TR-31-307-32



6,0 mm	TR-31-308-06	TR-31-309-06
9,0 mm	TR-31-308-09	TR-31-309-09
13,0 mm	TR-31-308-13	TR-31-309-13
16,0 mm	TR-31-308-16	TR-31-309-16
19,0 mm	TR-31-308-19	TR-31-309-19
25,0 mm	TR-31-308-25	TR-31-309-25
32,0 mm	TR-31-308-32	TR-31-309-32



Smith-Petersen, 20,0 cm

Bone Chisels and Gouges



Handle for blades, with key
TR-31-310-00



Interchangeable blades

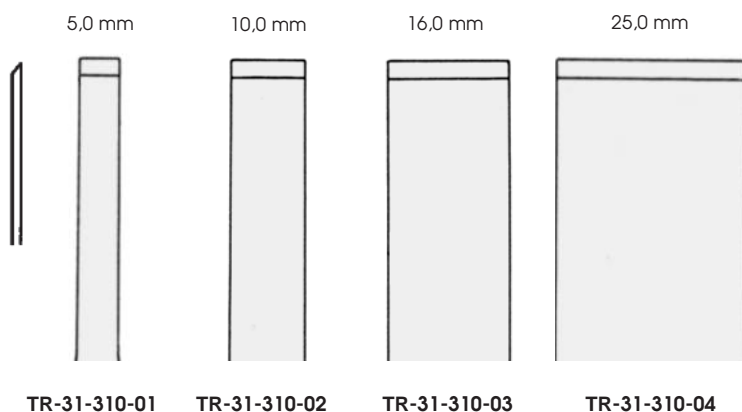

TR-31-310-01

TR-31-310-02

TR-31-310-03

TR-31-310-04

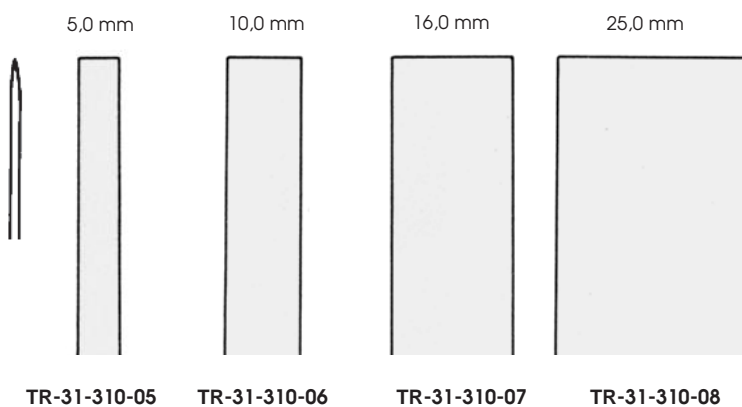

TR-31-310-05

TR-31-310-06

TR-31-310-07

TR-31-310-08

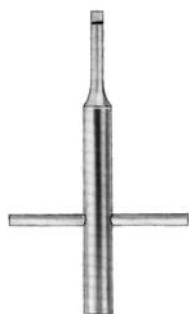

Key
TR-31-310-80

Bone Chisels and Gouges



Osteotom, 20,0 cm



10,0 mm

TR-31-313-10



10,0 mm

TR-31-314-10

15,0 mm

TR-31-313-15

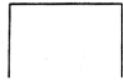

15,0 mm

TR-31-314-15

20,0 mm

TR-31-313-20

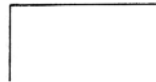

20,0 mm

TR-31-314-20



Osteotom, 20,0 cm



Lexer-Mini, 18,0 cm



4,0 mm
TR-31-316-04

6,0 mm
TR-31-316-06

8,0 mm
TR-31-316-08

10,0 mm
TR-31-316-10

12,0 mm
TR-31-316-12



Lexer-Mini, 18,0 cm



4,0 mm
TR-31-318-04

6,0 mm
TR-31-318-06

8,0 mm
TR-31-318-08

10,0 mm
TR-31-318-10

12,0 mm
TR-31-318-12

Bone Chisels and Gouges



Lexer, 22,0 cm

5,0 mm **TR-31-320-05**

7,0 mm **TR-31-320-07**

10,0 mm **TR-31-320-10**

15,0 mm **TR-31-320-15**

20,0 mm **TR-31-320-20**

25,0 mm **TR-31-320-25**

30,0 mm **TR-31-320-30**

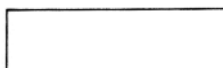
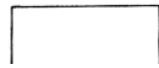
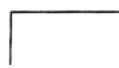

5,0 mm **TR-31-322-05**

7,0 mm **TR-31-322-07**

10,0 mm **TR-31-322-10**

15,0 mm **TR-31-322-15**

20,0 mm **TR-31-322-20**

25,0 mm **TR-31-322-25**

30,0 mm **TR-31-322-30**



Lexer, 22,0 cm



Spongiosa, 25,0 cm

5,0 mm
TR-31-326-05

10,0 mm
TR-31-326-100

15,0 mm
TR-31-326-15

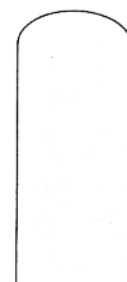

5,0 mm
TR-31-327-05

10,0 mm
TR-31-327-10

15,0 mm
TR-31-327-15



Spongiosa, 25,0 cm

Gouge and Raspatories

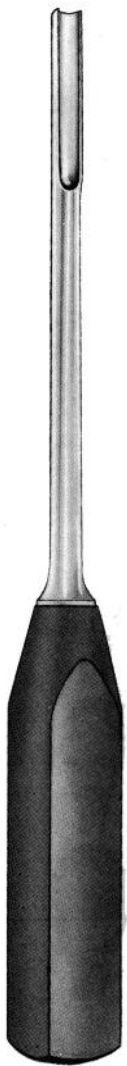

Lexer-Spongiosa, 28,0 cm



7,0 mm
TR-31-334-07

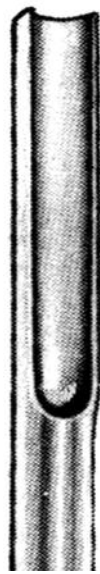

10,0 mm
TR-31-334-10

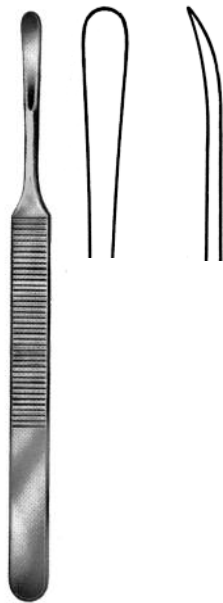

König, 5,0 mm
15,5 cm **TR-31-353-15**

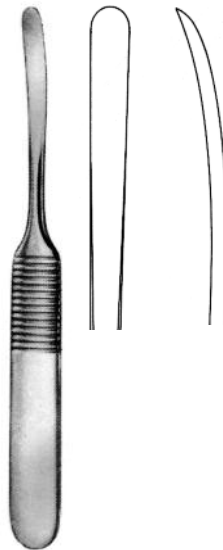

Williger, 4,2 mm
14,0 cm **TR-31-355-14**



Williger, 6,0 mm
16,0 cm **TR-31-355-16**

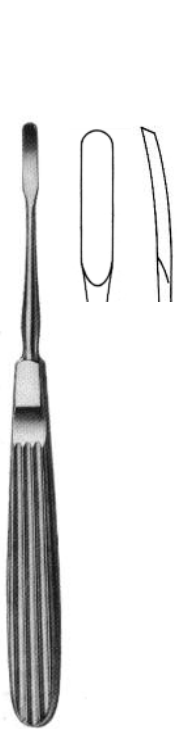

Joseph, 4,0 mm

16,0 cm **TR-31-356-17**

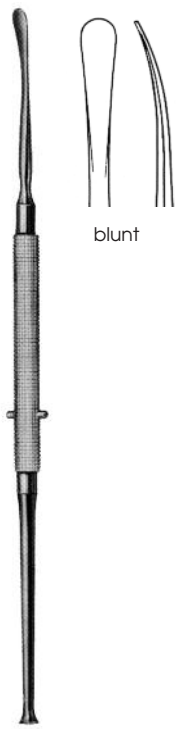

blunt

Freer, 4,0 mm

19,0 cm **TR-31-358-19**

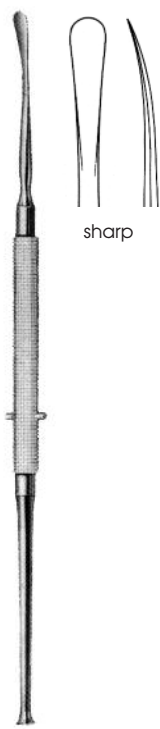

sharp

Freer, 4,0 mm

19,0 cm **TR-31-359-19**

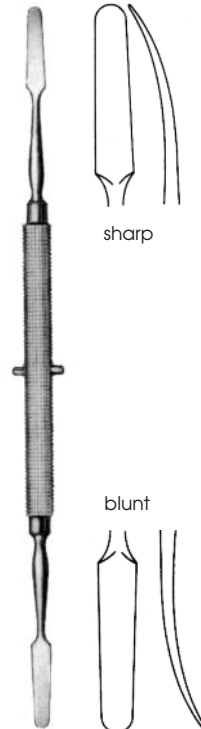

sharp

Killian

18,5 cm **TR-31-363-18**

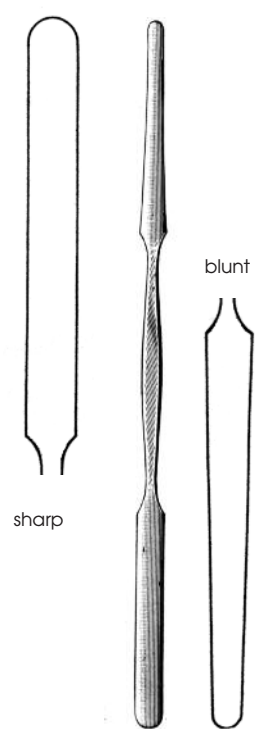

blunt

sharp

Killian

18,5 cm **TR-31-365-18**

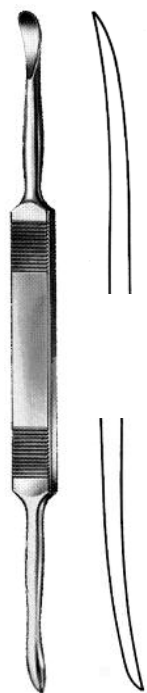

Ohl

19,0 cm **TR-31-372-19**

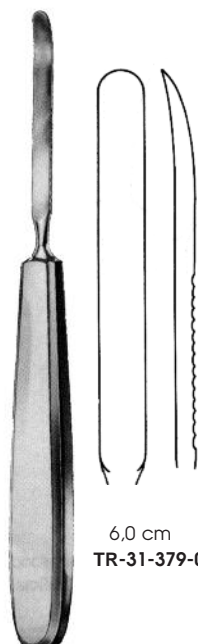

6,0 cm
TR-31-379-06

Raspatorium, 17,0 cm

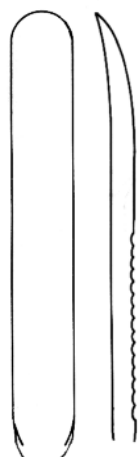

8,0 cm
TR-31-379-08



Adson, 17,0 cm



8,0 mm, Fig. 1
TR-31-380-01



7,0 mm, Fig. 3
TR-31-380-03



7,0 mm, Fig. 2
TR-31-380-02

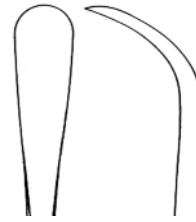

7,0 mm, Fig. 4
TR-31-380-04

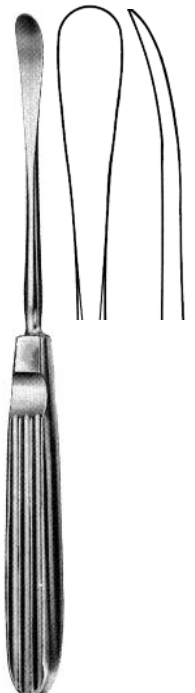

Cottle, 8,0 mm

19,5 cm **TR-31-382-19**



19,0 cm, 6 mm
TR-31-390-01



18,5 cm, 3 mm
TR-31-390-02



19,0 cm, 6 mm
TR-31-390-03



19,0 cm, 6 mm
TR-31-390-04



18,5 cm, 13 mm
TR-31-391-01



19,5 cm, 14 mm
TR-31-391-02

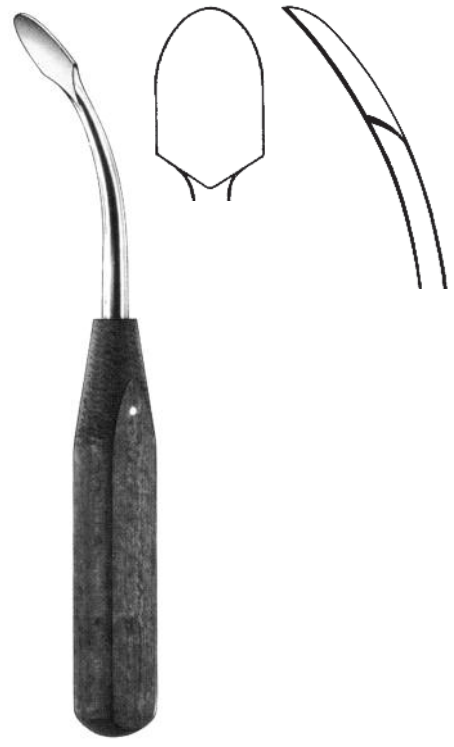

19,0 cm, 14 mm
TR-31-391-03

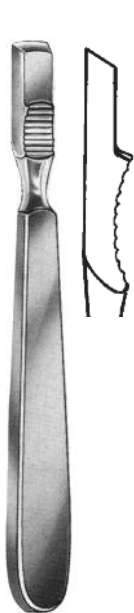

Farabeuf, 12,5 mm
15,0 cm TR-31-392-14

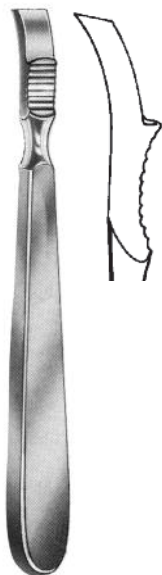

Farabeuf, 12,5 mm
15,0 cm TR-31-393-14



Farabeuf-Collin, 11,0 mm
16,0 cm TR-31-394-16



Farabeuf-Collin, 11,0 mm
16,0 cm TR-31-395-16

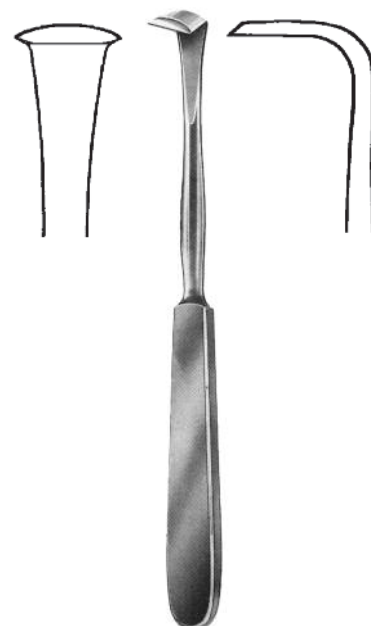

Langenbeck, 16 mm
16,5 cm TR-31-401-01



Langenbeck, 16 mm
19,0 cm TR-31-401-02



Sedillot, 14 mm
21,0 cm TR-31-404-21



Lambotte, 21,5 cm
5 mm TR-31-405-05
10 mm TR-31-405-10
15 mm TR-31-405-15
20 mm TR-31-405-20
25 mm TR-31-405-25

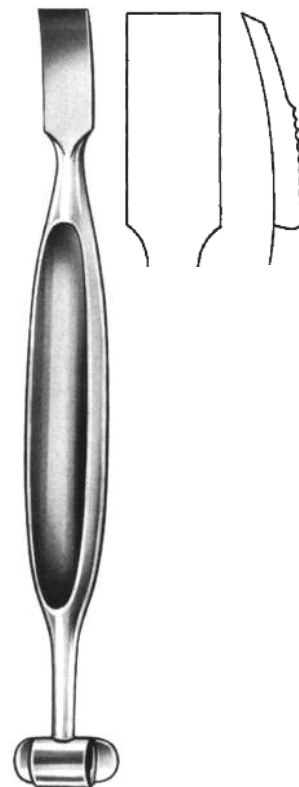

Alexander, 12 mm
21,0 cm TR-31-406-21

Raspatories



Semb



12 mm, 18 cm
TR-31-408-01



13 mm, 18 cm
TR-31-408-02



12 mm, 21 cm
TR-31-408-03



13 mm, 21 cm
TR-31-408-04



13 mm, 18 cm
TR-31-408-05



15 mm, 21 cm
TR-31-408-06



10 mm, 21 cm
TR-31-408-07



Doyen, 17,5 cm
TR-31-409-01 - TR-31-409-02 children
TR-31-410-01 - TR-31-410-02 adults



TR-31-409-01



TR-31-409-02

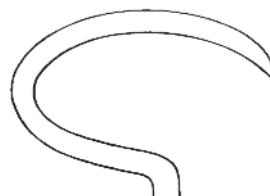

TR-31-410-01
TR-31-411-01

left curved

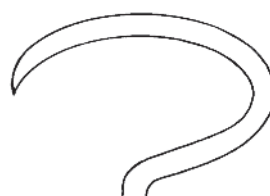

TR-31-410-02
TR-31-411-02

right curved



Doyen, 24,0 cm
TR-31-411-01 - TR-31-411-02

Raspatories

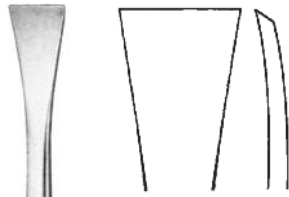

16 mm, 19 cm
TR-31-412-01

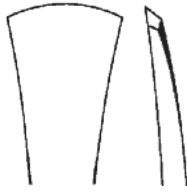

16 mm, 19 cm
TR-31-412-02

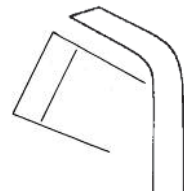

12 mm, 19 cm
TR-31-412-03

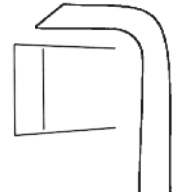

12 mm, 18 cm
TR-31-412-04



Langenbeck



Hoen

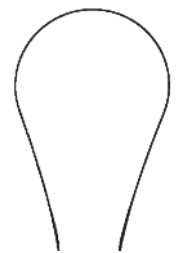

7 mm, 16 cm
TR-31-412-10

15 mm, 18,5 cm
TR-31-412-11

20 mm, 19 cm
TR-31-412-23



Cushing



4 mm, 17 cm
TR-31-412-20

6 mm, 17 cm
TR-31-412-21



5 mm, 19,5 cm
TR-31-412-25

7 mm, 19,5 cm
TR-31-412-26

8 mm, 17 cm
TR-31-412-30

Raspatories



Raspatorium, 16,0 cm

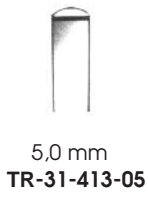

5,0 mm
TR-31-413-05



6,0 mm
TR-31-413-06



7,0 mm
TR-31-413-07



Obwegeser, 15,0 cm

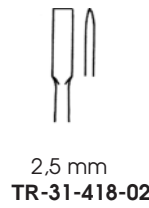

2,5 mm
TR-31-418-02

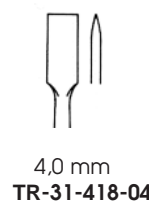

4,0 mm
TR-31-418-04

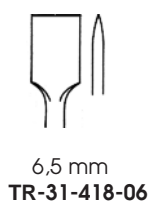

6,5 mm
TR-31-418-06



Raspatorium
27,5 cm TR-31-415-27 20 mm



Raspatorium
33,0 cm TR-31-416-01 8 mm
33,0 cm TR-31-416-02 17 mm

Elevators/Bone Levers

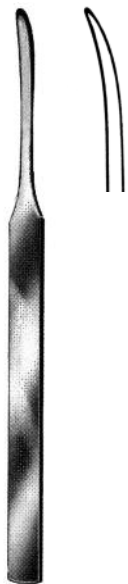

König, 4,5 mm
15,5 cm **TR-31-420-01**



König, 4,5 mm
15,5 cm **TR-31-420-02**

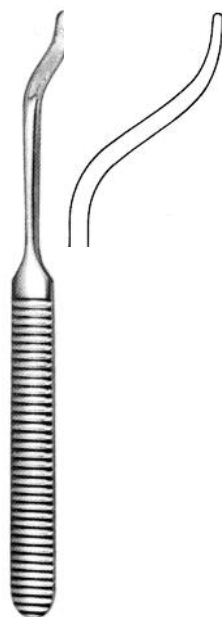

5,5 mm
15,5 cm **TR-31-421-16**



Williger



16,5 cm, 5,0 mm
TR-31-422-01



17,0 cm, 5,5 mm
TR-31-422-02

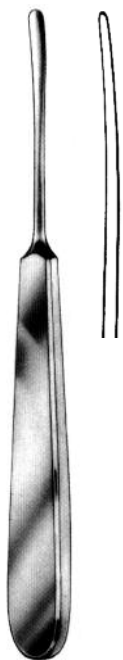

Sebileau, 5,0 mm
17,5 cm **TR-31-423-01**

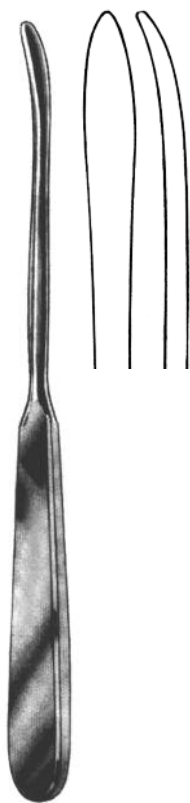

Quervain, 6,0 mm
20,0 cm **TR-31-423-02**



Langenbeck



19,5 cm, 8,0 mm
TR-31-423-03



19,5 cm, 10,0 mm
TR-31-423-04

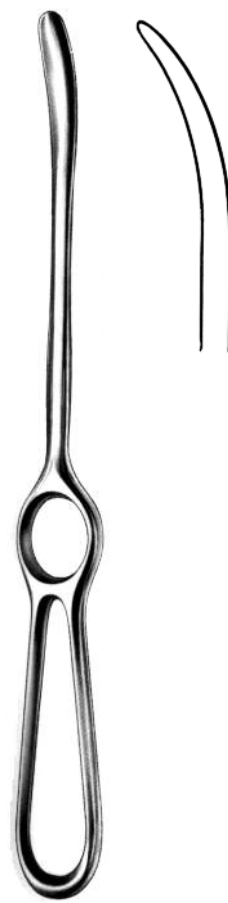

Langenbeck, 11,0 mm
23,0 cm **TR-31-423-05**

Elevators/Bone Levers



Martin-Langenbeck



17,0 cm, 5,0 mm
TR-31-423-15



17,0 cm, 7,0 mm
TR-31-423-17



17,0 cm, 8,0 mm
TR-31-423-18



20,0 cm, 10,0 mm
TR-31-423-19



2,8 mm
14,0 cm **TR-31-424-01**

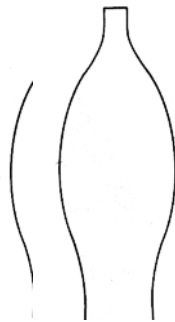

15,0 cm
4,5 mm **TR-31-424-0**



6,0 mm
TR-31-424-03



16,0 cm
2/6 mm **TR-31-425-02**

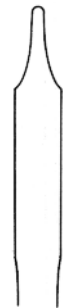

2/8 mm
TR-31-425-03



2/15 mm
12,5 cm **TR-31-425-04**

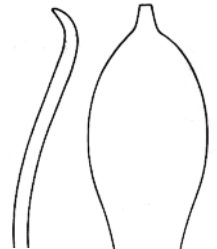

Bone Levers



Hohmann, 10 mm
22,0 cm **TR-31-428-01**

Hohmann, 17 mm
24,0 cm **TR-31-428-02**

Hohmann, 44 m
24,0 cm **TR-31-428-03**

Hohmann, 65 mm
25,5 cm **TR-31-428-04**

Bone Levers



Hohmann, 43 mm
25,0 cm **TR-31-428-05**

Hohmann, 24 mm
26,0 cm **TR-31-428-06**
27,0 cm **TR-31-428-09**

Hohmann, 34 mm
28,5 cm **TR-31-428-07**

Hohmann, 25 mm
26,0 cm **TR-31-428-08**

Bone Levers

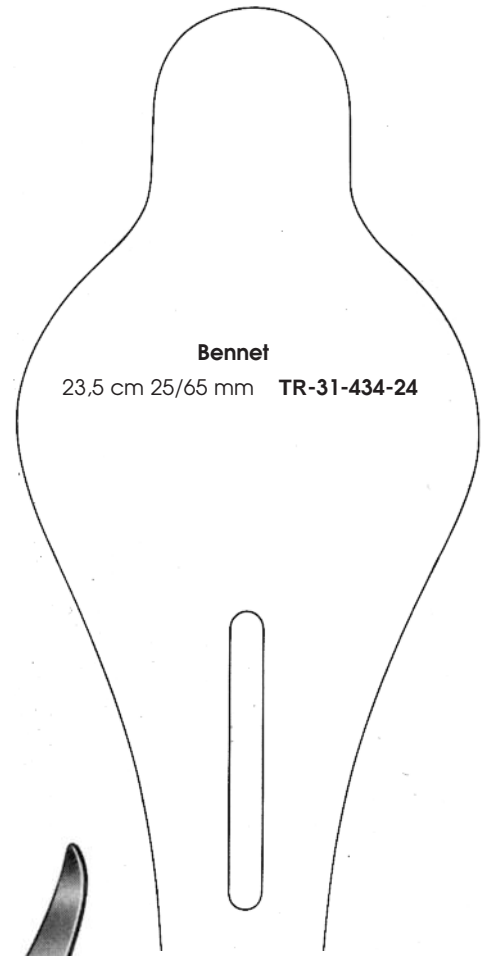
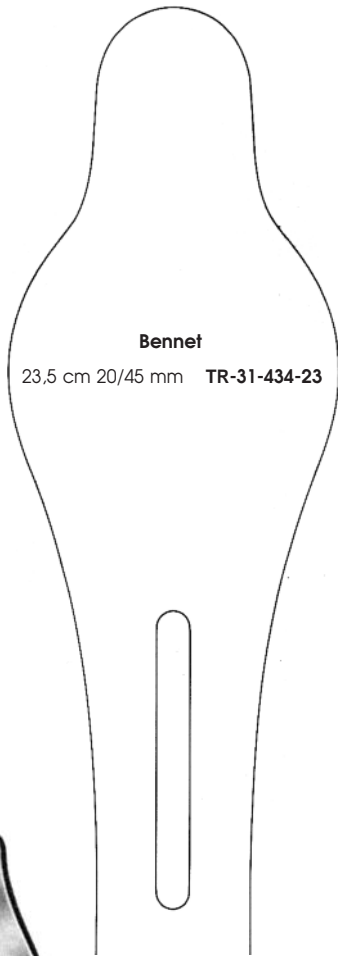

Blount, 38,0 mm
26,0 cm TR-31-436-26

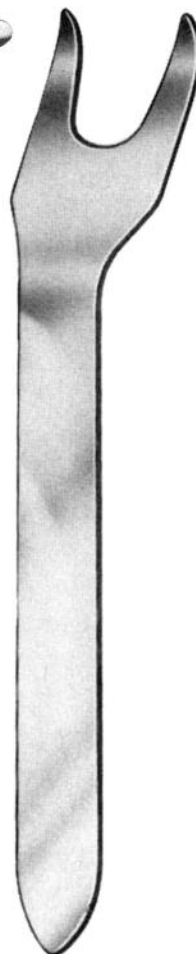

Blount, 2-zinkig, 38,0 mm
26,0 cm, TR-31-437-26

Files and Rasps



Josef, 16,5 cm

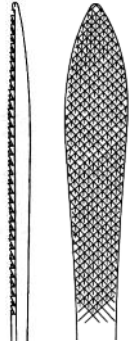

TR-31-440-01



TR-31-440-02



Lewis, 17,5 cm

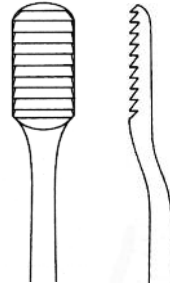

TR-31-441-01

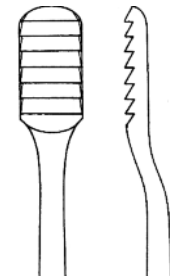

TR-31-441-02



Maltz, 9,0 mm
17,5 cm

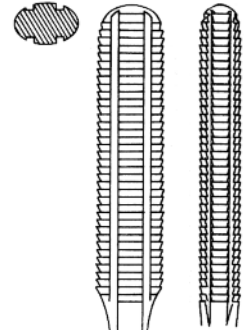

TR-31-442-18



Aufricht, 22,0 cm

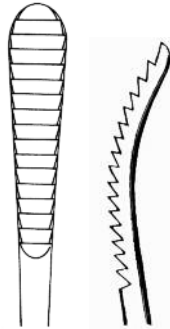

TR-31-443-01

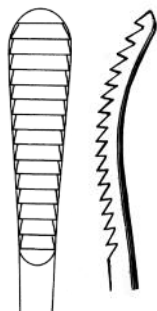

TR-31-443-02



Gallaher, 19,0 cm



Fig. 1
TR-31-444-01



Fig. 2
TR-31-444-02



Fig. 3
TR-31-444-03



Fomon, 21,5 cm

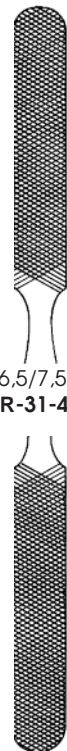

6,5/7,5 mm
TR-31-445-01

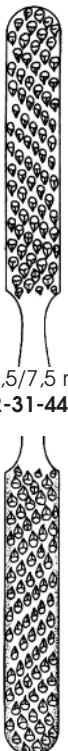

6,5/7,5 mm
TR-31-445-02

Files and Rasps



Raspel, 21,0 cm

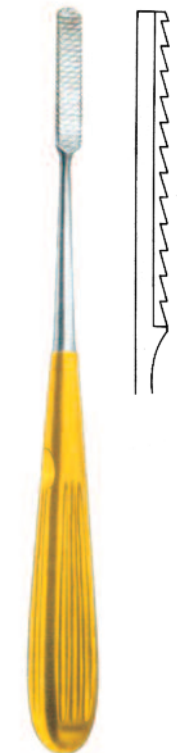
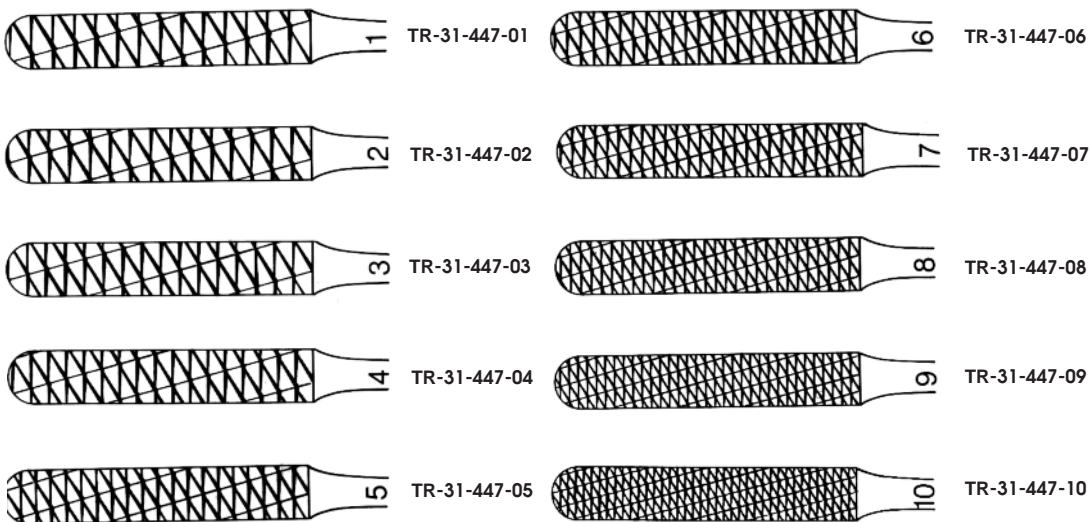
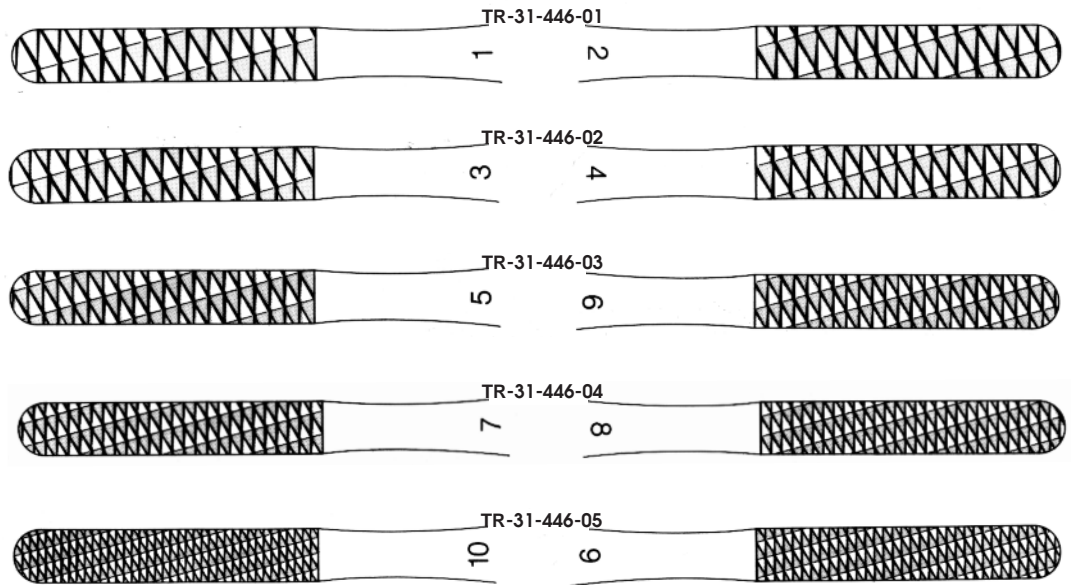

Maltz, 21,0 cm

Files and Rasps

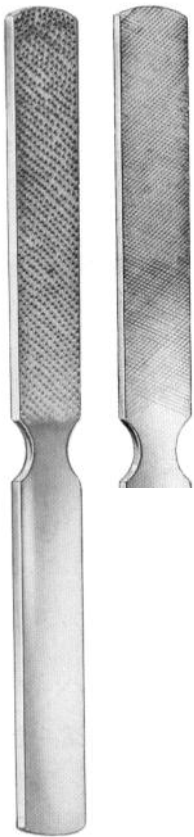

22,0 cm, 20 mm
TR-31-448-22

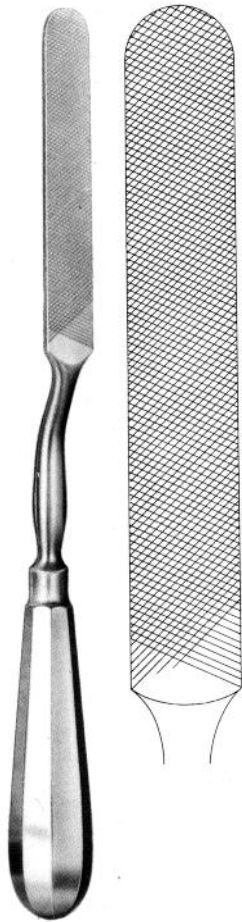

22,0 cm, 13 mm
TR-31-449-24

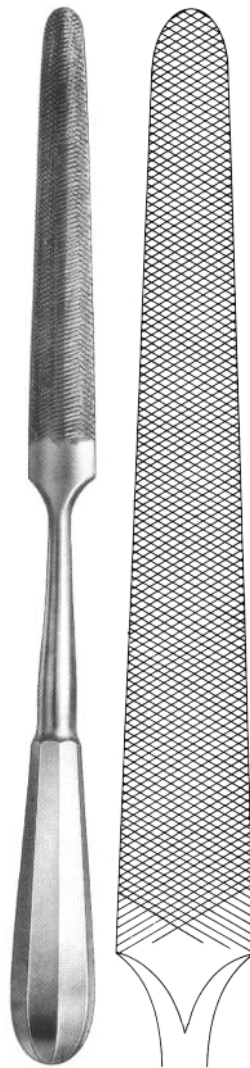

28,0 cm, 20 mm
TR-31-449-28



Putti
27,0 cm, 18/20 mm
TR-31-451-27



Putti
30,0 cm **TR-31-452-30**

Files and Rasps



Wiener, 18,0 cm

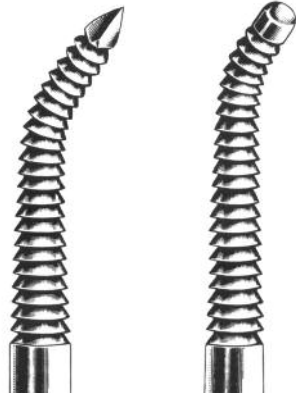

TR-31-453-01 TR-31-453-02

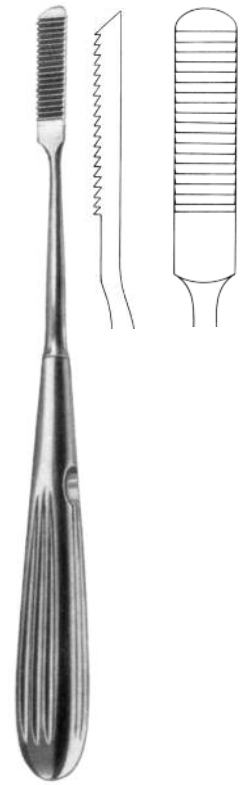

Cottle
21,0 cm TR-31-454-21



Fig. 1
TR-31-455-01

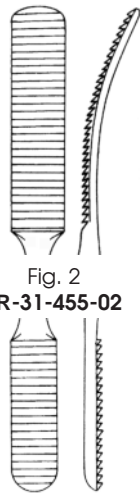

Fig. 2
TR-31-455-02

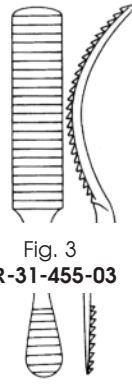

Fig. 3
TR-31-455-03

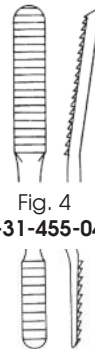

Fig. 4
TR-31-455-04

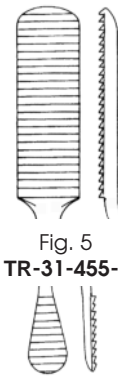
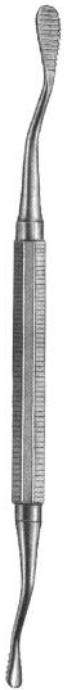

Fig. 5
TR-31-455-05



Miller, 19,0 cm



Fig. 1
TR-31-455-11



Fig. 2
TR-31-455-12

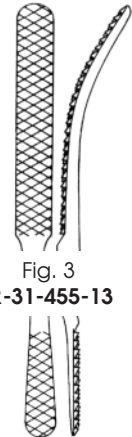

Fig. 3
TR-31-455-13



Fig. 4
TR-31-455-14



Miller, 19,0 cm

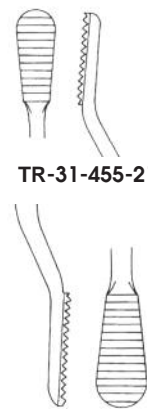

TR-31-455-21

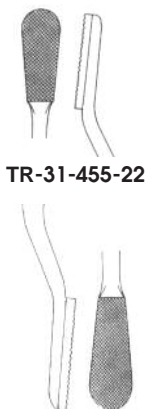

TR-31-455-22

Bone Curettes



Jacobson
14,0 cm
TR-31-460-01

Martini
14,0 cm
TR-31-460-02

Martini
14,0 cm
TR-31-460-03

Williger
14,5 cm
TR-31-460-04

Jansen
16,5 cm
TR-31-460-05

Barth
18,0 cm
TR-31-460-06

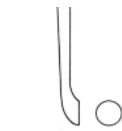
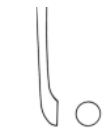

Volkman
13,0 cm
TR-31-461-01

Volkman
16,0 cm
TR-31-461-02

Volkman
20,0 cm
TR-31-461-03

13,0 cm
TR-31-462-01

14,5 cm
TR-31-462-02

17,0 cm 31-462-03
20,0 cm TR-31-462-04

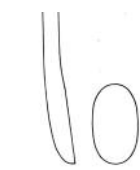
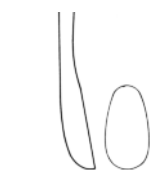
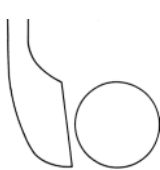

16,0 cm
TR-31-463-01

Jansen
16,0 cm
TR-31-463-02



Hemmingway
17,0 cm
TR-31-463-03

17,0 cm
TR-31-463-04



Fig. 00/0
TR-31-464-01

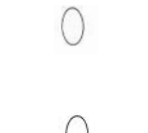

Fig. 0/1
TR-31-464-02

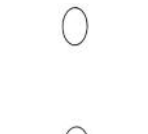

Fig. 1/2
TR-31-464-03

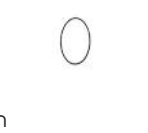

Fig. 0000
TR-31-465-01

Fig. 000
TR-31-465-02

Fig. 00
TR-31-465-03

Fig. 0
TR-31-465-04

Fig. 1
TR-31-465-05

Fig. 2
TR-31-465-06

Fig. 3
TR-31-465-07

Fig. 4
TR-31-465-08

Fig. 5
TR-31-465-09

Fig. 6
TR-31-465-10

Williger, 13,5 cm

Bruns, 17,0 cm



- 2,0 mm
TR-31-466-11
- 2,6 mm
TR-31-466-12
- 3,4 mm
TR-31-466-13
- 5,2 mm
TR-31-466-15

Williger, 17,0 cm



- Fig. 0000
TR-31-467-01
- Fig. 000
TR-31-467-02
- Fig. 00
TR-31-467-03
- Fig. 0
TR-31-467-04
- Fig. 1
TR-31-467-05
- Fig. 2
TR-31-467-06
- Fig. 3
TR-31-467-07
- Fig. 4
TR-31-467-08
- Fig. 5
TR-31-467-09
- Fig. 6
TR-31-467-10

Volkmann, 17,0 cm



- Fig. 0000
TR-31-468-01
- Fig. 000
TR-31-468-02
- Fig. 00
TR-31-468-03
- Fig. 0
TR-31-468-04
- Fig. 1
TR-31-468-05
- Fig. 2
TR-31-468-06
- Fig. 3
TR-31-468-07
- Fig. 4
TR-31-468-08
- Fig. 5
TR-31-468-09
- Fig. 6
TR-31-468-10

Spratt, 17,0 cm



- 1,0 mm
21,0 cm **TR-31-469-00**
- 1,7 mm
21,0 cm **TR-31-469-01**
- 2,0 mm
21,0 cm **TR-31-469-02**
17,0 cm **TR-31-469-20**
- 2,4 mm
21,0 cm **TR-31-469-03**
17,0 cm **TR-31-469-24**
- 2,7 mm
21,0 cm **TR-31-469-04**
17,0 cm **TR-31-469-27**
- 3,0 mm
21,0 cm **TR-31-469-05**
17,0 cm **TR-31-469-30**
- 3,3 mm
17,0 cm **TR-31-469-33**

Lempert

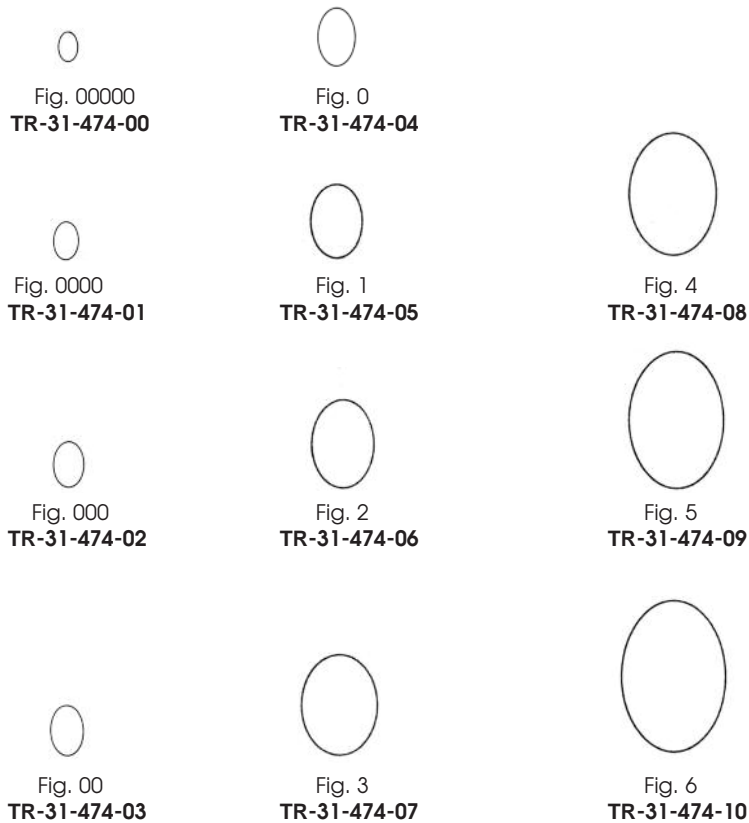
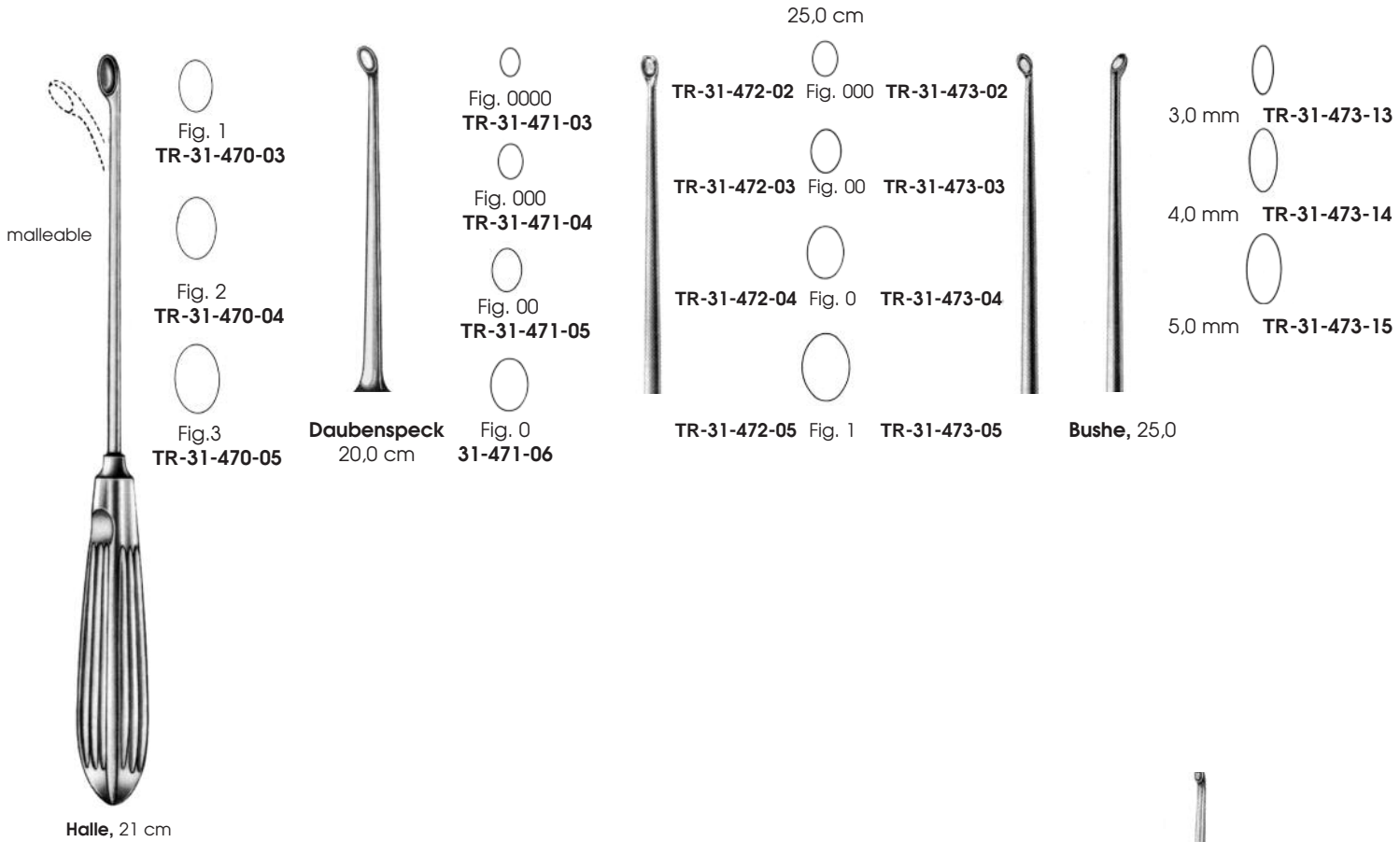



Volkmann

- | | | | |
|---------------------|---|---------------------|--|
| 17,0 cm |  | 27,0 cm | |
| TR-31-479-01 | Fig. 0000 | | |
| TR-31-479-02 | Fig. 000 | | |
| TR-31-479-03 | Fig. 00 | | |
| TR-31-479-04 | Fig. 0 | TR-31-480-04 | |
| TR-31-479-05 | Fig. 1 | TR-31-480-05 | |
| TR-31-479-06 | Fig. 2 | TR-31-480-06 | |
| TR-31-479-07 | Fig. 3 | TR-31-480-07 | |

- | | | |
|---------------------|--------|---------------------|
| 17,0 cm | | 27,0 cm |
| TR-31-479-08 | Fig. 4 | TR-31-480-08 |
| TR-31-479-09 | Fig. 5 | |
| TR-31-479-09 | Fig. 6 | |



Scoville, 25,0 cm

- | | |
|---|---------------------|
|  | 3WS-1-481-01 |
|  | TR-31-481-02 |
|  | TR-31-481-03 |



Bruns, 23,0 cm



















- | | |
|---|---|
|  |  |
| Fig. 0000 | Fig. 2 |
| TR-31-483-01 | TR-31-483-06 |
|  |  |
| Fig. 000 | Fig. 3 |
| TR-31-483-02 | TR-31-483-07 |
|  |  |
| Fig. 00 | Fig. 4 |
| TR-31-483-03 | TR-31-483-08 |
|  |  |
| Fig. 0 | Fig. 5 |
| TR-31-483-04 | TR-31-483-09 |
|  |  |
| Fig. 1 | Fig. 6 |
| TR-31-483-05 | TR-31-483-10 |



	Fig. 1	Fig. 2	Fig. 3	Fig. 4	Fig. 5	Fig. 6
						
TR-31-484-01	TR-31-484-02	TR-31-484-03	TR-31-484-04	TR-31-484-05	TR-31-484-06	
						
TR-31-485-01	TR-31-485-02	TR-31-485-03	TR-31-485-04	TR-31-485-05	TR-31-485-06	
						
TR-31-486-01	TR-31-486-02	TR-31-486-03	TR-31-486-04	TR-31-486-05	TR-31-486-06	

Bone Holding Forceps



14,0 cm **TR-31-502-14**



9,0 cm **TR-31-503-09**
13,0 cm **TR-31-503-13**
18,0 cm **TR-31-503-18**



12,0 cm **TR-31-506-12**



Lewin
17,5 cm **TR-31-508-17**



Reill
17,0 cm **TR-31-511-17**



20,5 cm **31-513-20**

Bone Holding Forceps

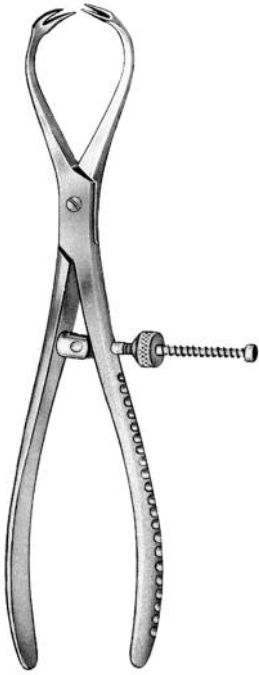

Patella Forceps
17,5 cm **TR-31-516-18**



14,0 cm **TR-31-519-14**

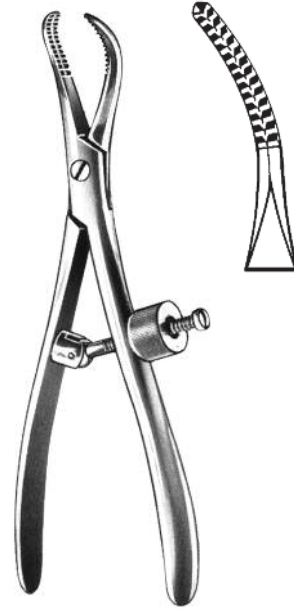

17,0 cm **TR-31-521-17**
23,0 cm **TR-31-521-23**

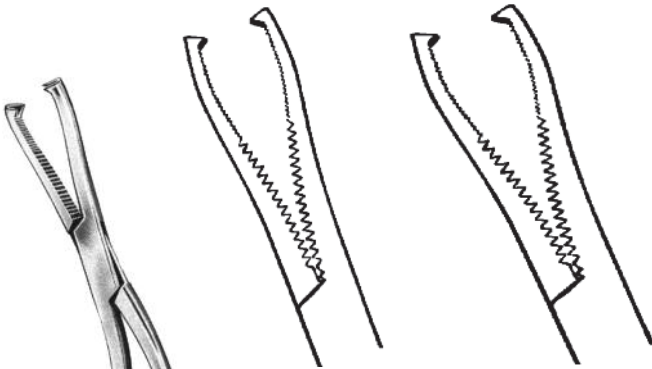

TR-31-523-18

TR-31-523-19

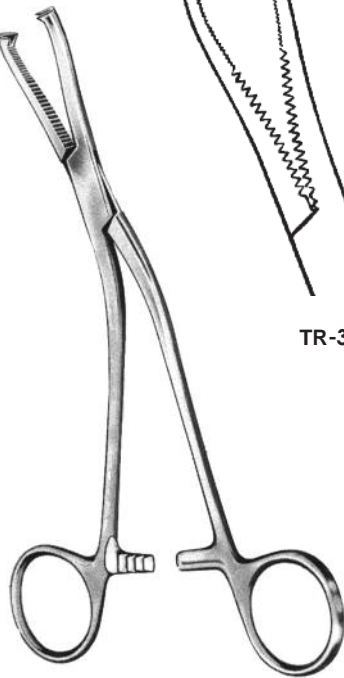

Dingmann, 18,0cm

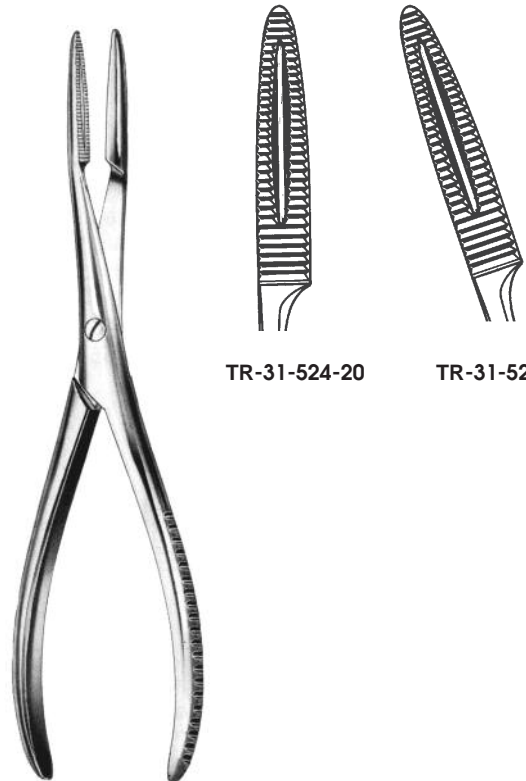

TR-31-524-20

TR-31-525-20

Sequestrum Forceps
20,0 cm

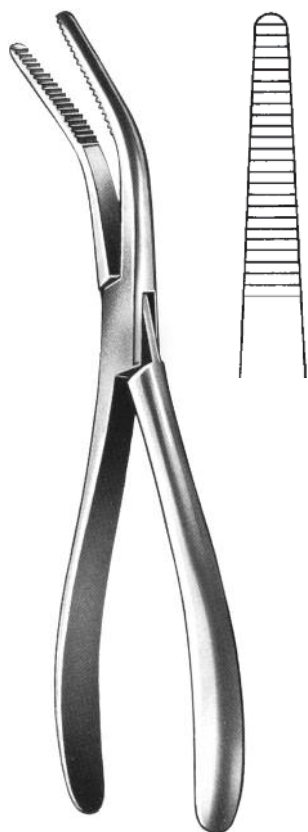

Van Buren
22,5 cm TR-31-527-23



22,5 cm
TR-31-528-20



Frosch
18,0 cm TR-31-529-18



Langenbeck
20,0 cm TR-31-530-20



Fergusson
20,0 cm TR-31-532-20



Semb
19,0 cm TR-31-533-19

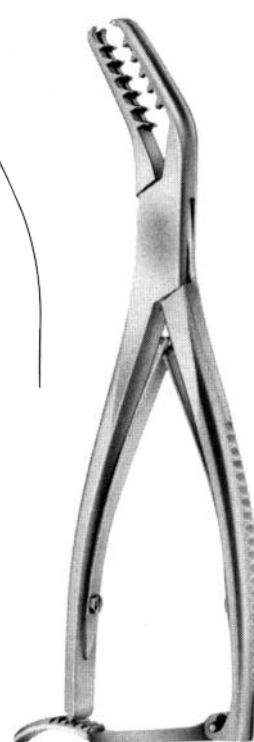

Semb
19,0 cm TR-31-535-19

Bone Holding Forceps



Farabeuf

23,0 cm **TR-31-536-23** 9,0 mm 25,0 cm **TR-31-538-25** 11,0 mm
25,0 cm **TR-31-536-25** 11,0 mm

Farabeuf



23,0 cm
TR-31-546-23
TR-31-547-23



25,0 cm
TR-31-546-25
TR-31-547-25



28,0 cm
TR-31-546-28
TR-31-547-28

Ulrich

TR-31-546-23 - TR-31-546-28

Ulrich

TR-31-547-23 - TR-31-547-28

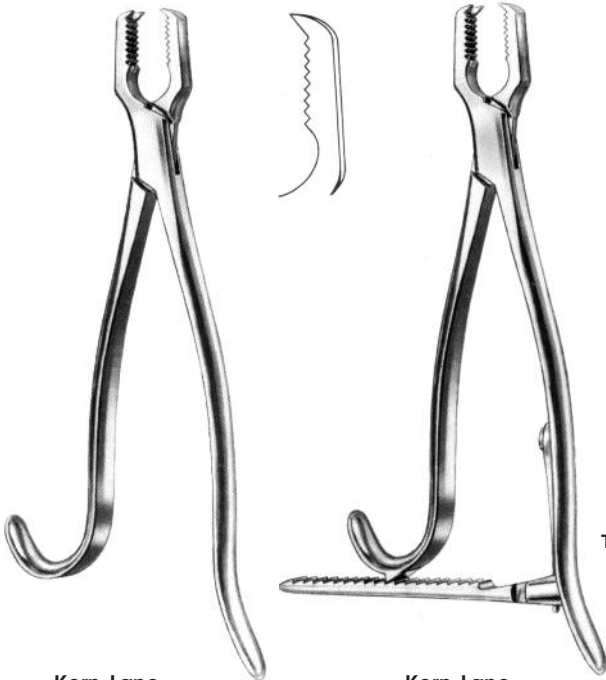

Kern-Lane

15,0 cm **TR-31-540-15**, 7,0 mm 15,0 cm **TR-31-542-15**, 7,0 mm
17,0 cm **TR-31-540-17**, 7,0 mm 17,0 cm **TR-31-542-17**, 7,0 mm
21,0 cm **TR-31-540-21**, 8,0 mm 21,0 cm **TR-31-542-21**, 8,0 mm
24,0 cm **TR-31-540-24**, 9,0 mm 24,0 cm **TR-31-542-24**, 9,0 mm
33,0 cm **TR-31-540-33**, 10,0 mm 33,0 cm **TR-31-542-33**, 10,0 mm
45,0 cm **TR-31-540-45**, 12,0 mm 45,0 cm **TR-31-542-45**, 12,0 mm

Kern-Lane

Bone Holding Forceps

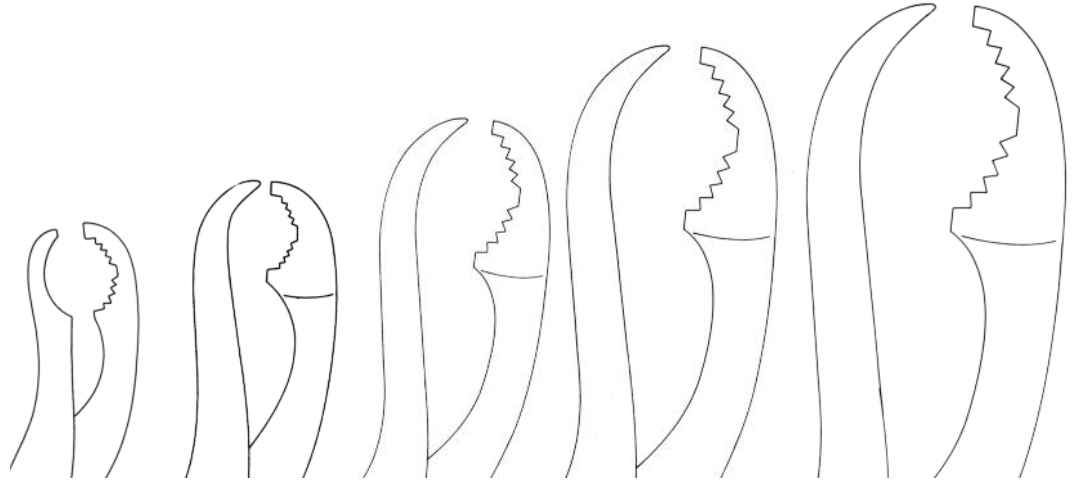

15,0 cm
TR-31-549-15

19,0 cm
TR-31-549-19

24,0 cm
TR-31-549-24

26,0 cm
TR-31-549-26

28,0 cm
TR-31-549-28

self-centering with thread fixation

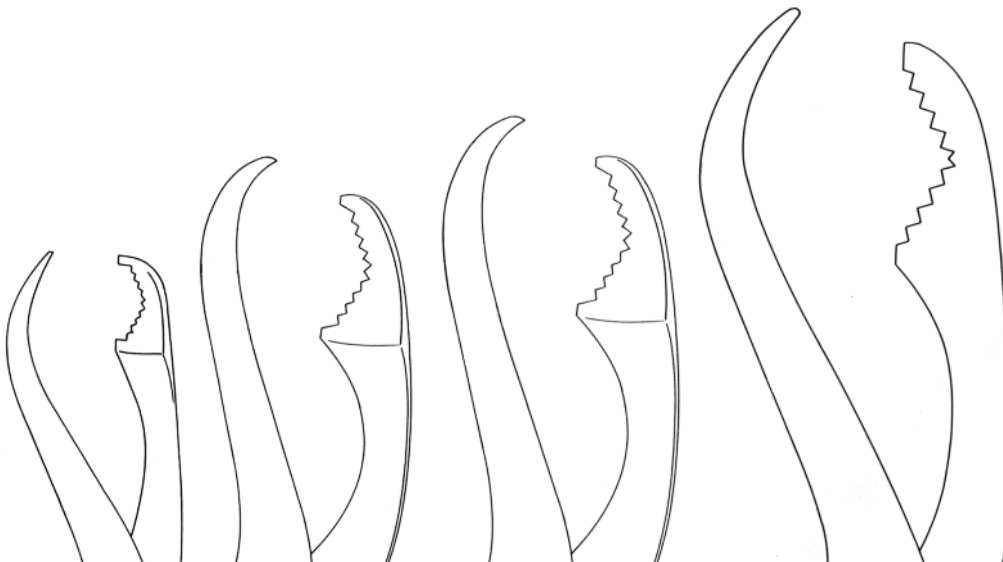

17,0 cm
TR-31-551-17

25,0 cm
TR-31-551-25

26,0 cm
TR-31-551-26

27,0 cm
TR-31-551-27



Verbrugge

Bone Holding Forceps



Lambotte
22,0 cm TR-31-552-22
27,0 cm TR-31-552-27

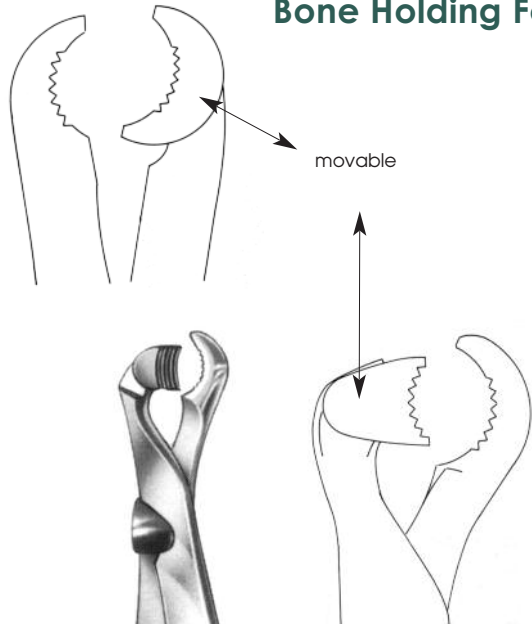

Lambotte
22,0 cm TR-31-554-22
26,0 cm TR-31-554-26
33,0 cm TR-31-554-33

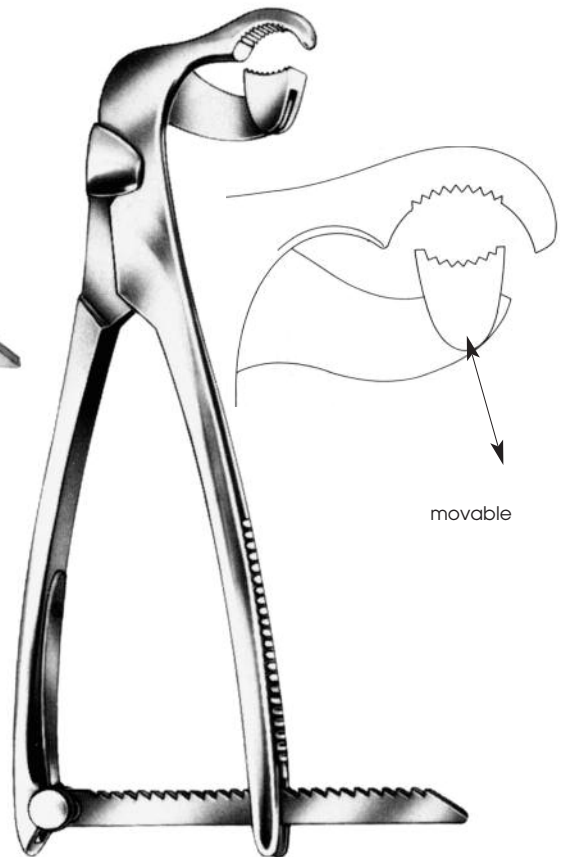

Lambotte
19,0 cm TR-31-555-19
23,0 cm TR-31-555-23
26,0 cm TR-31-556-26

Bone Rongeur Forceps

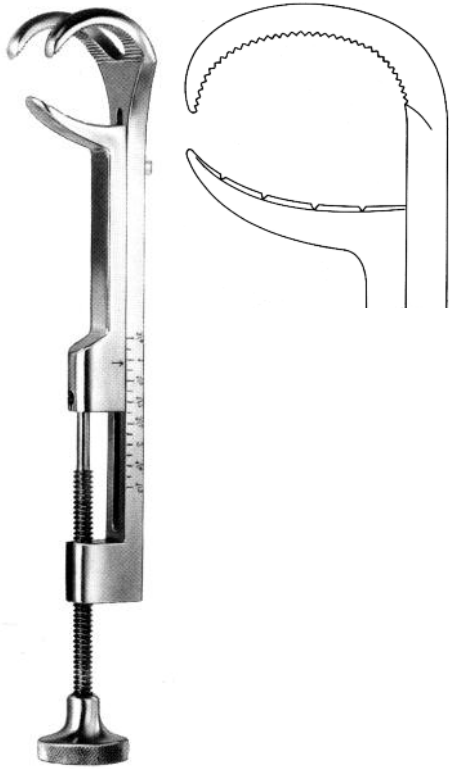

Lowmann

TR-31-561-13 - TR- 31-561-22

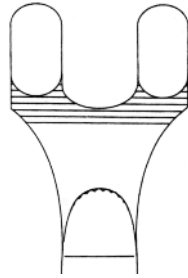

13,0 cm
TR-31-561-13

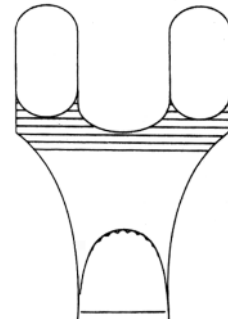

18,0 cm
TR-31-561-18

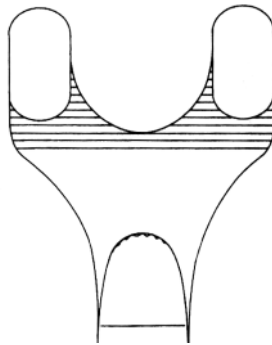

20,0 cm
TR-31-561-20

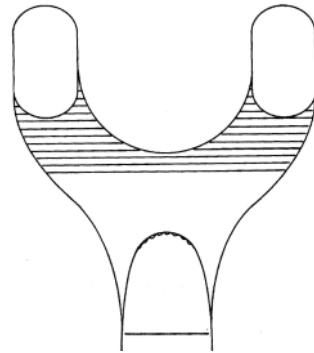

22,0 cm
TR-31-561-22

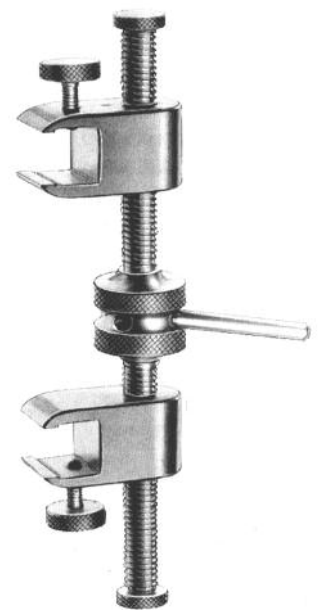

Gerster

15,0 cm **TR-31-564-00**



TR-31-601-01

Synovectomy Rongeur
13 cm, 1,2 mm



TR-31-601-02

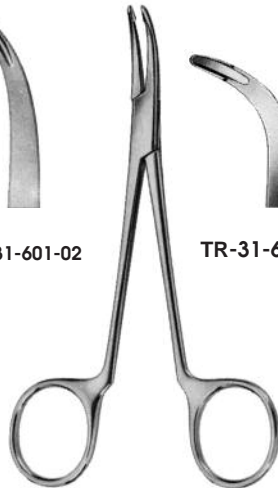

TR-31-603-01

Synovectomy Rongeur
13 cm, 2,0 mm



TR-31-603-02



Stellbrink, 17 cm



TR-31-605-01



TR-31-605-02



Friedmann
12 cm TR-31-607-12



Luer-Friedmann
14,5 cm TR-31-607-14



Friedmann-Vickers
14,0 cm TR-31-608-14



Luer, 15,0 cm



TR-31-611-01



TR-31-611-02



TR-31-611-03

Bone Rongeur Forceps

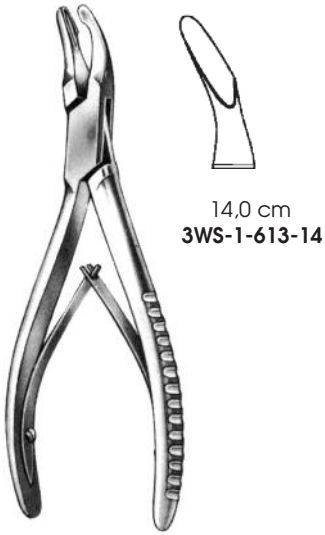

14,0 cm
3WS-1-613-14



17,0 cm
TR-31-613-17



Blumenthal, 15,0 cm

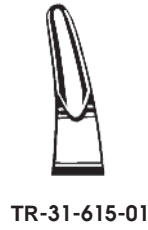

TR-31-615-01



TR-31-615-02



TR-31-615-03

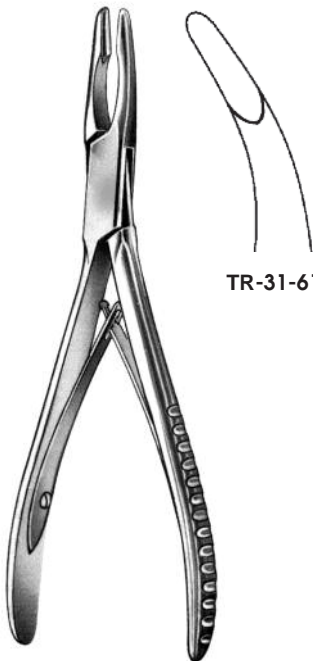

TR-31-617-16



TR-31-617-17

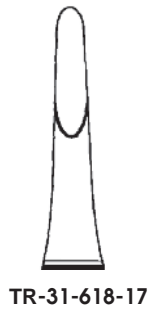

TR-31-618-17



Hartmann
17,0 cm TR-31-619-17



TR-31-622-20



TR-31-623-20

Lemper, 20,0 cm

Bone Rongeur Forceps



Mead, 16,5 cm



TR-31-627-01



TR-31-627-02



Luer



**17,0 cm
TR-31-628-17**



**17,0 cm
TR-31-629-17**



**18,0 cm
TR-31-630-18**



**18,0 cm
TR-31-631-18**



Böhler



**3,0 mm
15,0 cm
TR-31-640-03**



**3,0 mm
15,0 cm
TR-31-641-03**



**3,0 mm
15,5 cm
TR-31-641-15**

**4,0 mm
15,0 cm
TR-31-640-04**

**4,0 mm
15,0 cm
TR-31-641-04**

**5,0 mm
5,0 cm
TR-31-640-05**

**5,0 mm
15,0 cm
TR-31-641-05**

Bone Rongeur Forceps



Mayfield
17,0 cm TR-31-645-17



Marquardt
20,0 cm TR-31-647-20



Beyer
18,0 cm TR-31-649-18



Zaufal-Janson
18,0 cm TR-31-651-18



Ruskin



18,0 cm TR-31-653-05
24,0 cm TR-31-655-05

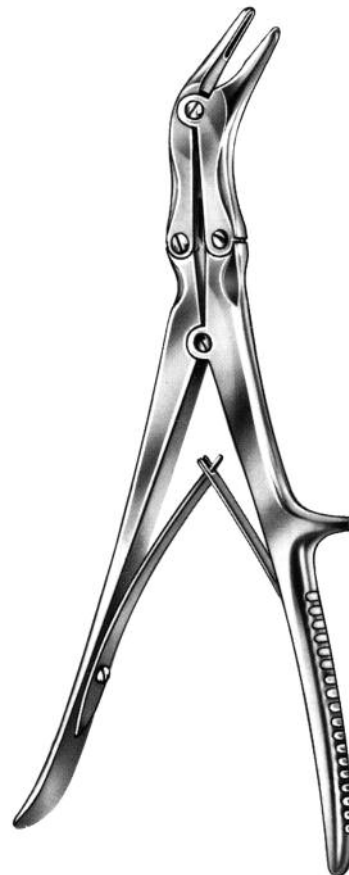

Echlin, 23,0 cm



TR-31-658-02



TR-31-658-03



TR-31-658-04



Frykholm
24,0 cm TR-31-659-24



Stille
23,5 cm TR-31-660-06



Leksell-Stille, 24,0 cm



TR-31-662-03



TR-31-662-07



Stille-Ruskin
24,0 cm
TR-31-663-24



Luer-Stille, 22,0 cm



TR-31-664-22



TR-31-665-22

Bone Rongeur Forceps



Luer-Stillé



23,0 cm
TR-31-666-23



27,0 cm
TR-31-666-27

23,0 cm
TR-31-667-23

27,0 cm
TR-31-667-27



Markwalder
19,0 cm TR-31-669-19

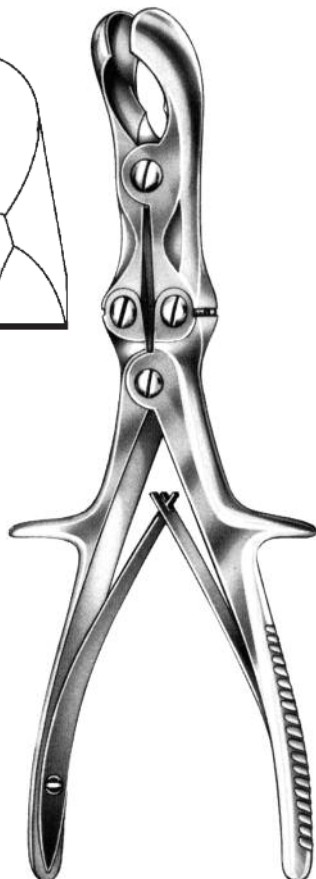

Semb
24,0 cm TR-31-669-24



TR-31-670-01



TR-31-670-02

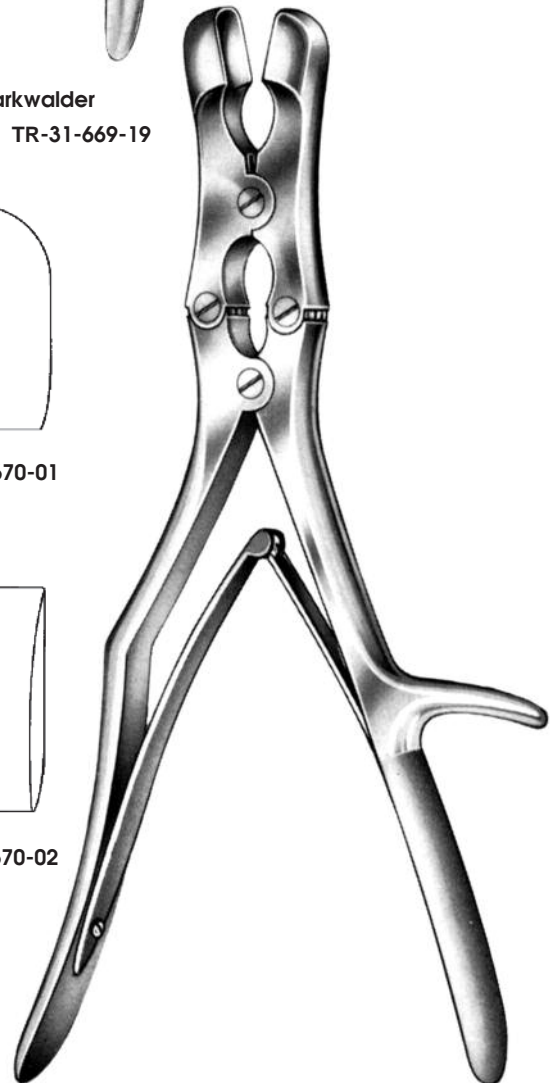

Sauerbruch-Coryllos, 31,0 cm

Bone Cutting Forceps



Cleveland
15,0 cm TR-31-701-15



Cleveland
17,0 cm TR-31-701-17



Gardner, 16,0 cm



4,0 mm
TR-31-703-04



6,0 mm
TR-31-703-06



Cottle
19,0 cm TR-31-704-19



Liston



14,0 cm
TR-31-706-14



17,0 cm
TR-31-706-17

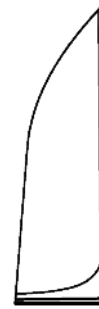

20,0 cm
TR-31-706-20



22,0 cm
TR-31-706-22



14,0 cm
TR-31-707-14

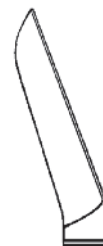

17,0 cm
TR-31-707-17

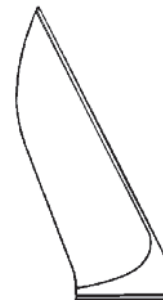

20,0 cm
TR-31-707-20



22,0 cm
TR-31-707-22

Bone Cutting Forceps



Böhler
15,0 cm
WS-31-708-15



Mc Indoe
17,5 cm
WS-31-711-18



Böhler
15,0 cm
WS-31-709-15



Ruskin- Liston



19,0 cm
WS-31-712-19



19,0 cm
WS-31-713-19



Liston



Liston
28,0 cm
WS-31-714-28



Liston
24,0 cm
WS-31-715-24



Liston
28,0 cm
WS-31-715-28

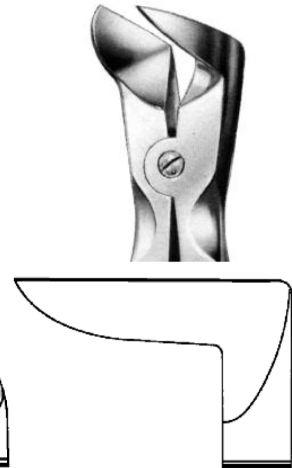

Liston-Stillé
27,0 cm
WS-31-717-27



Liston-Key
27,0 cm TR-31-719-27



Semb
24,0 cm TR-31-721-24

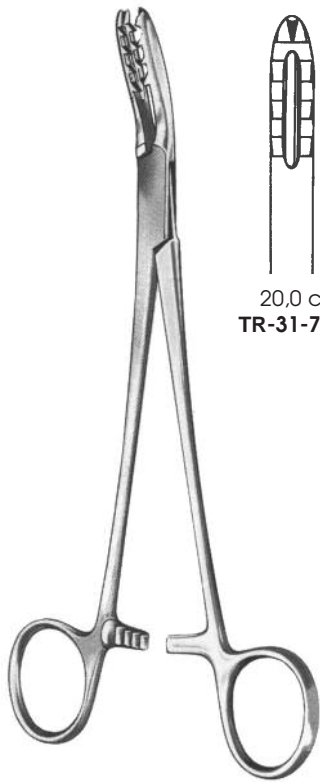

20,0 cm
TR-31-738-20

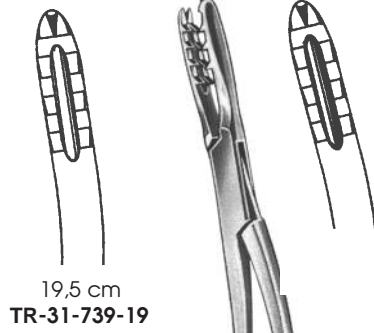

19,5 cm
TR-31-739-19

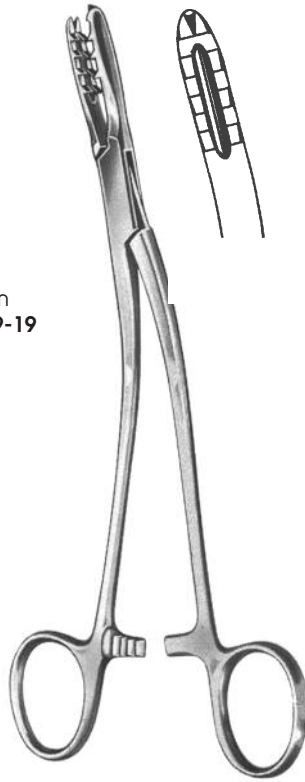

Bircher-Ganske
20,0 cm TR-31-739-20



Martin
20,5 cm TR-31-740-20

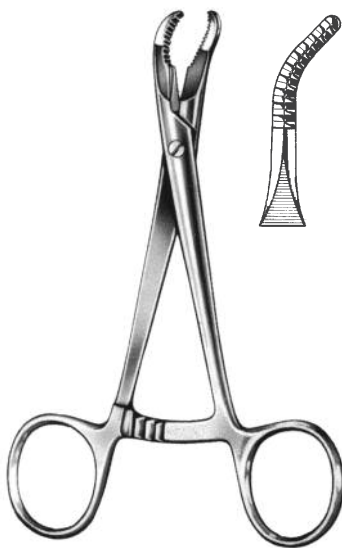

Cartilage Seizing Forceps
13,5 cm TR-31-741-14



Neff, 13,5 cm



TR-31-742-01



TR-31-747-02



Salenius, 22,0 cm
TR-31-745-01



TR-31-745-02

Meniscus Instruments



Bircher, 19,5 cm



TR-31-754-01



TR-31-754-02



Smillie
17,0 cm **TR-31-755-01**



Smillie
17,0 cm **TR-31-755-02**



Smillie
17,0 cm **TR-31-755-03**

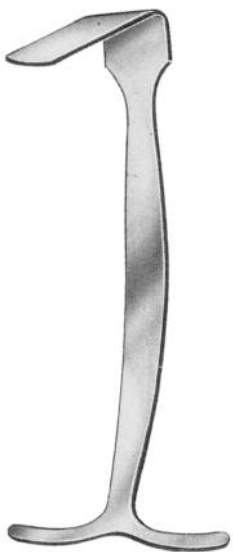

Smillie, 14,0 cm



TR-31-760-01 32x19 mm
TR-31-760-02 48x19 mm
TR-31-760-03 57x19 mm



TR-31-760-04 52x13 mm



TR-31-760-05 12 x 13 mm

Meniscus and Tendon Instruments

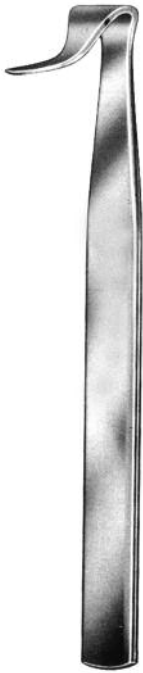

Blount, 40 x 4 mm
17,5 cm **TR-31-762-17**

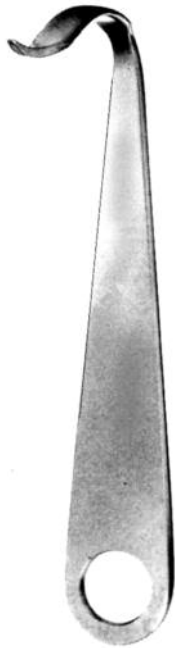

75 x 30 mm
17,0 cm **TR-31-763-17**



Taylor
16,5 cm, 75 x 30 mm **TR-31-764-01**
16,5 cm, 100 x 30 mm **TR-31-764-02**

Tendon Interlacing Forceps

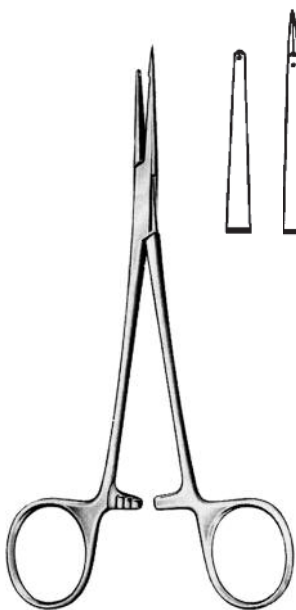

15,0 cm **TR-31-770-15**

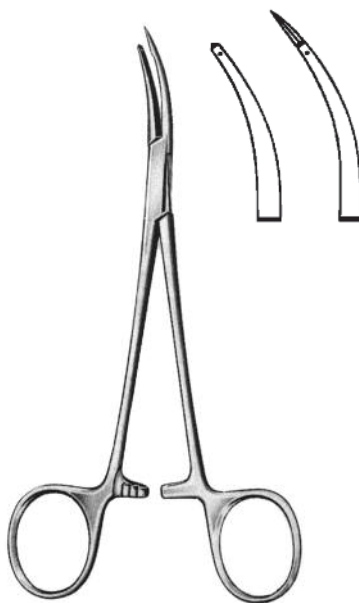

15,0 cm **TR-31-771-15**

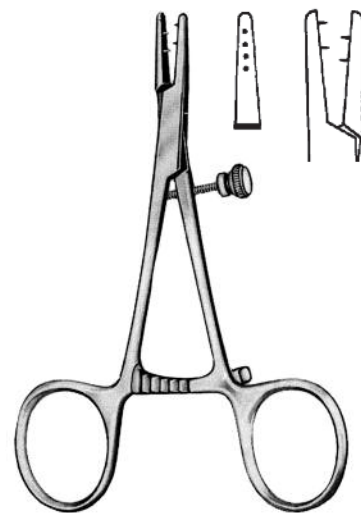

Tendon Seizing Forceps
12,0 cm **TR-31-772-12**

Meniscus and Tendon Instruments

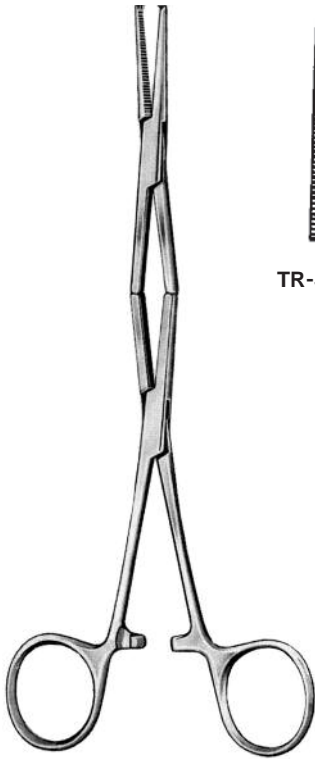

Tendon Seizing Forceps
20,5 cm



TR-31-774-20



TR-31-775-20



Tendon Seizing Forceps
11,0 cm **TR-31-777-11**



15,0 cm

TR-31-778-15

straight
curved



18,0 cm

TR-31-778-18

straight
curved



24,0 cm

TR-31-778-24

straight
curved



Brand

Tendon Seizing Forceps

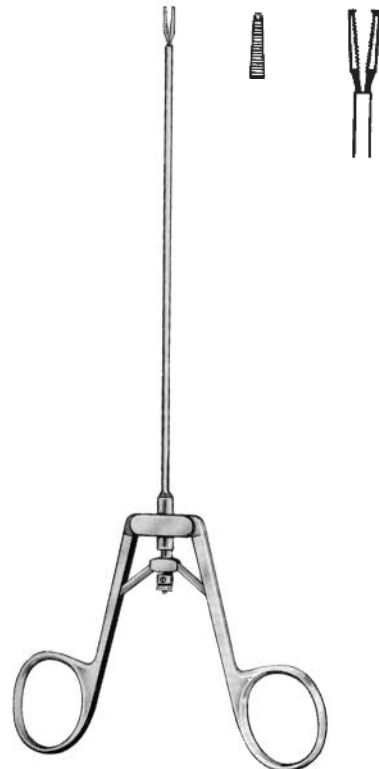

Kleinert-Kutz

Tendon Passing Forceps
20,5 cm **TR-31-781-20**

Wire Extension



Kirschner

- 95 x 70 mm **TR-31-801-01**
- 95 x 110 mm **TR-31-801-02**
- 105 x 110 mm **TR-31-801-03**
- 120 x 120 mm **TR-31-801-04**
- 135 x 130 mm **TR-31-801-05**
- 155 x 155 mm **TR-31-801-06**
- 200 x 155 mm **TR-31-801-07**



adjustable

- 40 - 140 **TR-31-802-01**
- 65 - 140 **TR-31-802-02**
- 60 - 220 **TR-31-802-03**



Kirschner, amerik. Modell
American type

- max. 105 mm **TR-31-803-01**
- max. 160 mm **TR-31-803-02**
- max. 200 mm **TR-31-803-03**



Böhler

- 16 x 9 mm **TR-31-804-01**
- 21 x 11 mm **TR-31-804-02**
- 21 x 15 mm **TR-31-804-03**



wire tightener
with clamping jaws
TR-31-804-01



Wrench
TR-31-806-01



Traction hook
TR-31-807-00



Traction hook
TR-31-808-00

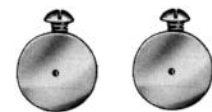

Fixation Disc, pair
TR-31-809-00

Drilling Chucks, Cerclage Instruments



Drilling chuck
for shanks up to Ø 4,5 mm
6,35 mm **TR-31-813-00**



Drilling chuck
for shanks up to 6,35 mm
TR-31-816-00



Key for drilling chuck 31-816-00
TR-31-816-01



Wire, soft

10 m x 0,2 mm	TR-31-821-02
10 m x 0,3 mm	TR-31-821-03
10 m x 0,4 mm	TR-31-821-04
10 m x 0,5 mm	TR-31-821-05
10 m x 0,6 mm	TR-31-821-06
10 m x 0,7 mm	TR-31-821-07
10 m x 0,8 mm	TR-31-821-08
10 m x 0,9 mm	TR-31-821-09
10 m x 1,0 mm	TR-31-821-10
10 m x 1,2 mm	TR-31-821-12
10 m x 1,5 mm	TR-31-821-15
10 m x 2,0 mm	TR-31-821-20

Wire, TITAN

10 m x 0,8 mm	TR-31-821-38
10 m x 1,0 mm	TR-31-821-40



Loute

Wire tightener
22,0 cm **TR-31-822-22**



Demel

Wire tightening forceps
27,0 cm **TR-31-824-27**



Demel

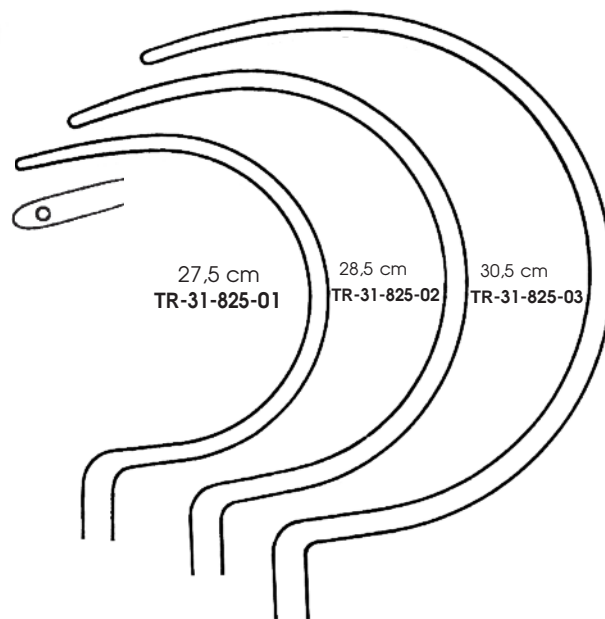

27,5 cm
TR-31-825-01

28,5 cm
TR-31-825-02

30,5 cm
TR-31-825-03

Wire Guide

Wire Extension

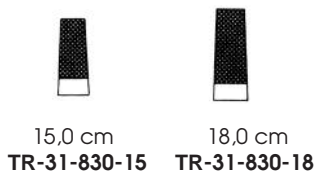

15,0 cm TR-31-830-15 18,0 cm TR-31-830-18

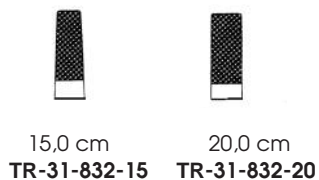

15,0 cm TR-31-832-15 20,0 cm TR-31-832-20

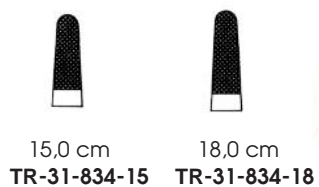

15,0 cm TR-31-834-15 18,0 cm TR-31-834-18

TR-31-830-15 - TR-31-834-18



15,0 cm TR-31-835-15



18,5 cm TR-31-836-18



Corwig-Hegar
16,0 cm TR-31-838-16



14,0 cm TR-31-850-14

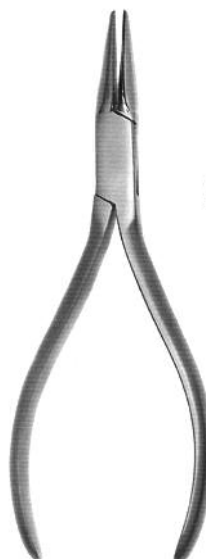

TR-31-851-01 - TR-31-851-03

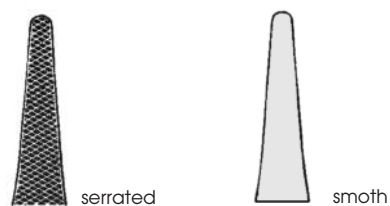

serrated smooth

TR-31-851-01 14,0 cm
jaws serrated

TR-31-851-02 14,0 cm
one jaw serrated, one jaw smooth

TR-31-851-03 14,0 cm
jaws smooth

Wire Extension



15,0 cm **TR-31-852-15**



16,0 cm **TR-31-852-16**

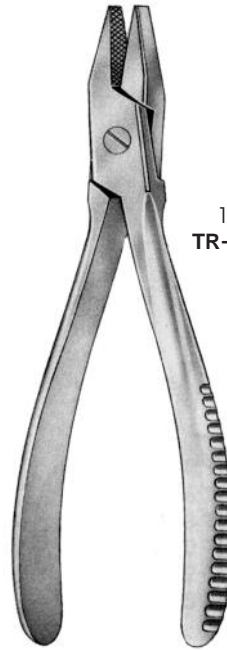

TR-31-854-01 - **TR-31-854-03**



17,0 cm
TR-31-854-01



17,0 cm
TR-31-854-02



19,0 cm
TR-31-854-03



17,0 cm **TR-31-856-17**

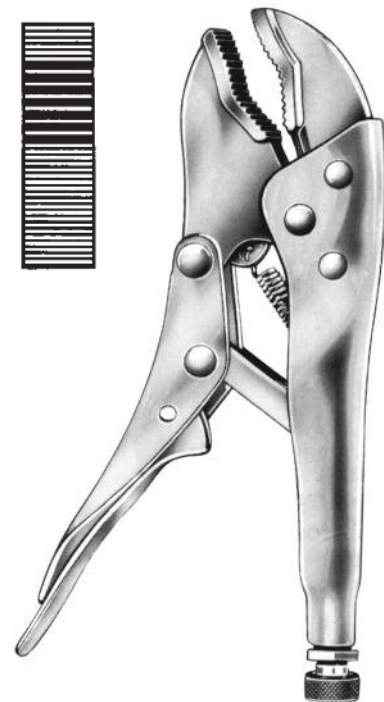

18,0 cm **TR-31-858-18**

Wire Extension

Standard

TC



TR-31-862-01



TR-31-863-01

TR-31-862-02



TR-31-863-02

TR-31-862-03

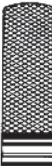

TR-31-863-03



18,0 cm TR-31-864-18



12,0 cm TR-31-865-12
14,0 cm TR-31-868-14

18,0 cm
TR-31-862-01 - TR-31-863-03



22,0 cm TR-31-873-22



17,0 cm TR-31-874-17



14,5 cm TR-31-882-14



16,0 cm TR-31-884-16



18,0 cm TR-31-886-18

Wire Cutting Pliers

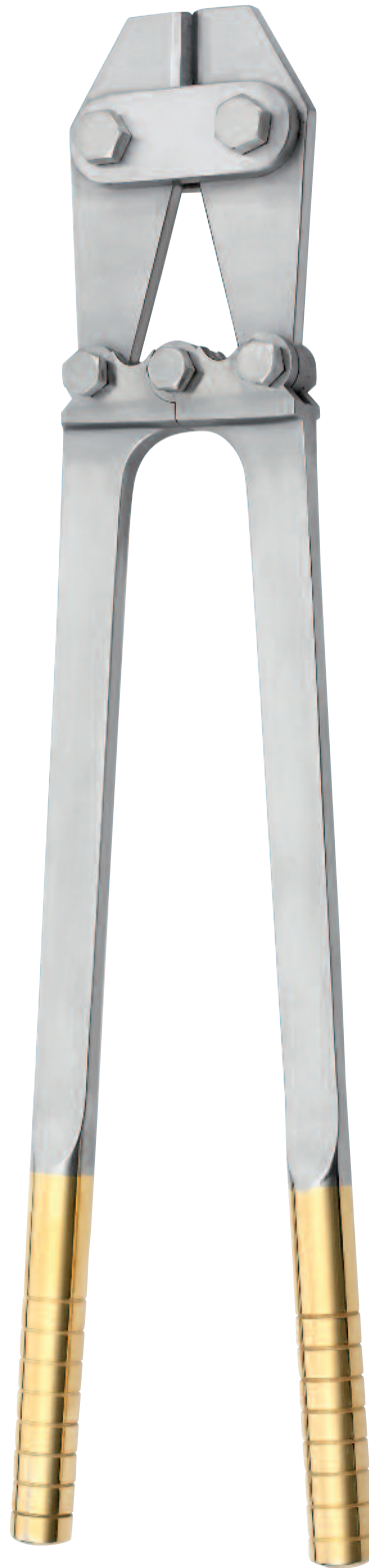

47,0 cm TR-31-890-47
57,0 cm TR-31-890-57

TR-31-890-98 Spare Currens (Pair) TR-31-890-47
TR-31-890-99 Spare Currens (Pair) TR-31-890-57

Hand Drills

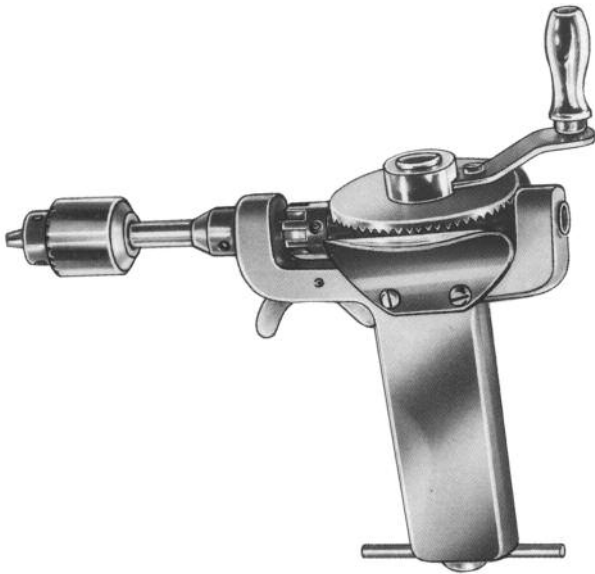

Bunnell
TR-31-909-00



TR-31-914-00

Hudson, complete
TR-31-916-00



Extension piece
TR-31-916-09

Hudson, alone
TR-31-916-10



Hudson
Fig.1 Ø 9 mm
TR-31-916-01



Hudson
Fig. 2 Ø 14 mm
TR-31-916-02



Hudson
Fig. 3 Ø 16 mm
TR-31-916-03



Hudson
Fig. 3 Ø 22 mm
TR-31-916-04



Cushing
Ø 14 mm
TR-31-916-05



Hudson
Ø 2 mm
TR-31-916-06



Mc Kenzie
Ø 13 mm
TR-31-916-07



Adson
Ø 15 mm
TR-31-916-08

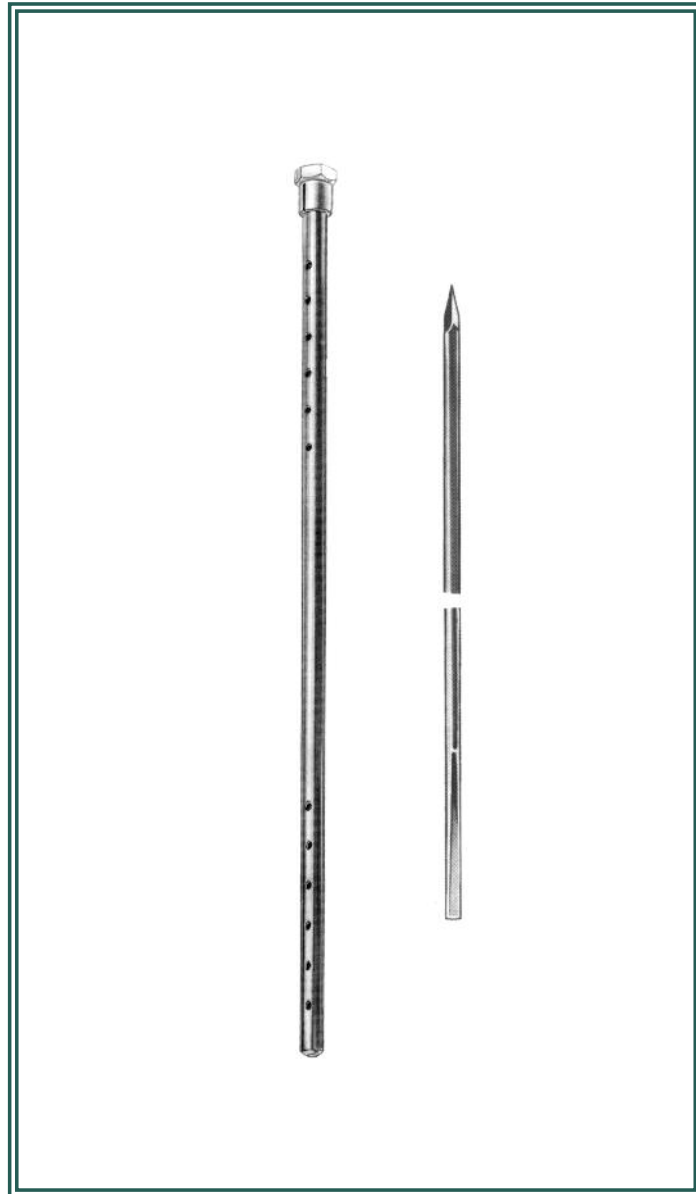

19

Kirschner Wire

Kirschner wires dispenser/Kirschner Wires



clear size markings on the dispenser
sterilization and storage in dispenser possible

for Kirschner Wires

TR-32-018-08	0,8 mm	18,0 cm
TR-32-018-10	1,0 mm	18,0 cm
TR-32-018-11	1,1 mm	18,0 cm
TR-32-018-12	1,2 mm	18,0 cm
TR-32-018-13	1,3 mm	18,0 cm
TR-32-018-14	1,4 mm	18,0 cm
TR-32-018-15	1,5 mm	18,0 cm
TR-32-018-16	1,6 mm	18,0 cm
TR-32-018-17	1,7 mm	18,0 cm
TR-32-018-18	1,8 mm	18,0 cm
TR-32-018-20	2,0 mm	18,0 cm
TR-32-018-22	2,2 mm	18,0 cm
TR-32-018-25	2,5 mm	18,0 cm
TR-32-018-30	3,0 mm	18,0 cm

TR-32-033-08	0,8 mm	33,0 cm
TR-32-033-10	1,0 mm	33,0 cm
TR-32-033-11	1,1 mm	33,0 cm
TR-32-033-12	1,2 mm	33,0 cm
TR-32-033-13	1,3 mm	33,0 cm
TR-32-033-14	1,4 mm	33,0 cm
TR-32-033-15	1,5 mm	33,0 cm
TR-32-033-16	1,6 mm	33,0 cm
TR-32-033-17	1,7 mm	33,0 cm
TR-32-033-18	1,8 mm	33,0 cm
TR-32-033-20	2,0 mm	33,0 cm
TR-32-033-22	2,2 mm	33,0 cm
TR-32-033-25	2,5 mm	33,0 cm
TR-32-033-30	3,0 mm	33,0 cm



Trocar point

mm Ø	length 60 mm	length 100 mm	length 150 mm	length 310 mm
0,6	TR-32-060-06	TR-32-100-06	TR-32-150-06	TR-32-310-06
0,8	TR-32-060-08	TR-32-100-08	TR-32-150-08	TR-2-310-08
0,9	TR-32-060-09	TR-32-100-09	TR-32-150-09	TR-32-310-09
1,0	TR-32-060-10	TR-32-100-10	TR-32-150-10	TR-32-310-10
1,1	TR-32-060-11	TR-32-100-11	TR-32-150-11	TR-32-310-11
1,2	TR-32-060-12	TR-32-100-12	TR-32-150-12	TR-32-310-12
1,3	TR-32-060-13	TR-32-100-13	TR-32-150-13	TR-32-310-13
1,4	TR-32-060-14	TR-32-100-14	TR-32-150-14	TR-32-310-14
1,5	TR-32-060-15	TR-32-100-15	TR-32-150-15	TR-32-310-15
1,6	TR-32-060-16	TR-32-100-16	TR-32-150-16	TR-32-310-16
1,7	TR-32-060-17	TR-32-100-17	TR-32-150-17	TR-32-310-17
1,8	TR-32-060-18	TR-32-100-18	TR-32-150-18	TR-32-310-18
1,9	TR-32-060-19	TR-32-100-19	TR-32-150-19	TR-32-310-19
2,0	TR-32-060-20	TR-32-100-20	TR-32-150-20	TR-32-310-20
2,2	TR-32-060-22	TR-32-100-22	TR-32-150-22	TR-32-310-22
2,4	TR-32-060-24	TR-2-100-24	TR-32-150-24	TR-32-310-24
2,5	TR-32-060-25	TR-32-100-25	TR-32-150-25	TR-32-310-25
3,0	TR-32-060-30	TR-32-100-30	TR-32-150-30	TR-32-310-30

with flat shaft

□
Kirschner

in packages with 10 pieces

Kirschner Wires



Trocar point

with round shaft

Kirschner

mm Ø	length 60 mm	length 100 mm	length 150 mm	length 310 mm
0,6	TR-32-061-06	TR-32-101-06	TR-32-151-06	TR-32-311-06
0,8	TR-32-061-08	TR-32-101-08	TR-32-151-08	TR-32-311-08
0,9	TR-32-061-09	TR-32-101-09	TR-32-151-09	TR-32-311-09
1,0	TR-32-061-10	TR-32-101-10	TR-32-151-10	TR-32-311-10
1,1	TR-32-061-11	TR-32-101-11	TR-32-151-11	TR-32-311-11
1,2	TR-32-061-12	TR-32-101-12	TR-32-151-12	TR-32-311-12
1,3	TR-32-061-13	TR-32-101-13	TR-32-151-13	TR-32-311-13
1,4	TR-32-061-14	TR-32-101-14	TR-32-151-14	TR-32-311-14
1,5	TR-32-061-15	TR-32-101-15	TR-32-151-15	TR-32-311-15
1,6	TR-32-061-16	TR-32-101-16	TR-32-151-16	TR-32-311-16
1,7	TR-32-061-17	TR-32-101-17	TR-32-151-17	TR-32-311-17
1,8	TR-32-061-18	TR-32-101-18	TR-32-151-18	TR-32-311-28
1,9	TR-32-061-19	TR-32-101-19	TR-32-151-19	TR-32-311-19
2,0	TR-32-061-20	TR-32-101-20	TR-32-151-20	TR-32-311-20
2,2	TR-32-061-22	TR-32-101-22	TR-32-151-22	TR-32-311-22
2,4	TR-32-061-24	TR-32-101-24	TR-32-151-24	TR-32-311-24
2,5	TR-32-061-25	TR-32-101-25	TR-32-151-25	TR-32-311-25
3,0	TR-32-061-30	TR-32-101-30	TR-32-151-30	TR-32-311-30

in packages with 10 pieces



Trocar point

with trocar shaft

mm Ø	length 100 mm	length 150 mm	length 310 mm
0,6	TR-32-102-06	TR-32-152-06	TR-32-312-06
0,8	TR-32-102-08	TR-32-152-08	TR-32-312-08
0,9	TR-32-102-09	TR-32-152-09	TR-32-312-09
1,0	TR-32-102-10	TR-32-152-10	TR-32-312-10
1,1	TR-32-102-11	TR-32-152-11	TR-32-312-11
1,2	TR-32-102-12	TR-32-152-12	TR-32-312-12
1,3	TR-32-102-13	TR-32-152-13	TR-32-312-13
1,4	TR-32-102-14	TR-32-152-14	TR-32-312-14
1,5	TR-32-102-15	TR-32-152-15	TR-32-312-15
1,6	TR-32-102-16	TR-32-152-16	TR-32-312-16
1,7	TR-32-102-17	TR-32-152-17	TR-32-312-17
1,8	TR-32-102-18	TR-32-152-18	TR-32-312-28
1,9	TR-32-102-19	TR-32-152-19	TR-32-312-19
2,0	TR-32-102-20	TR-32-152-20	TR-32-312-20
2,2	TR-32-102-22	TR-32-152-22	TR-32-312-22
2,4	TR-32-102-24	TR-32-152-24	TR-32-312-24
2,5	TR-32-102-25	TR-32-152-25	TR-32-312-25
3,0	TR-32-102-30	TR-32-152-30	TR-32-312-30

in packages with 10 pieces

Further Kirschner Wires with thread tips, other length and from Titanium are possible.

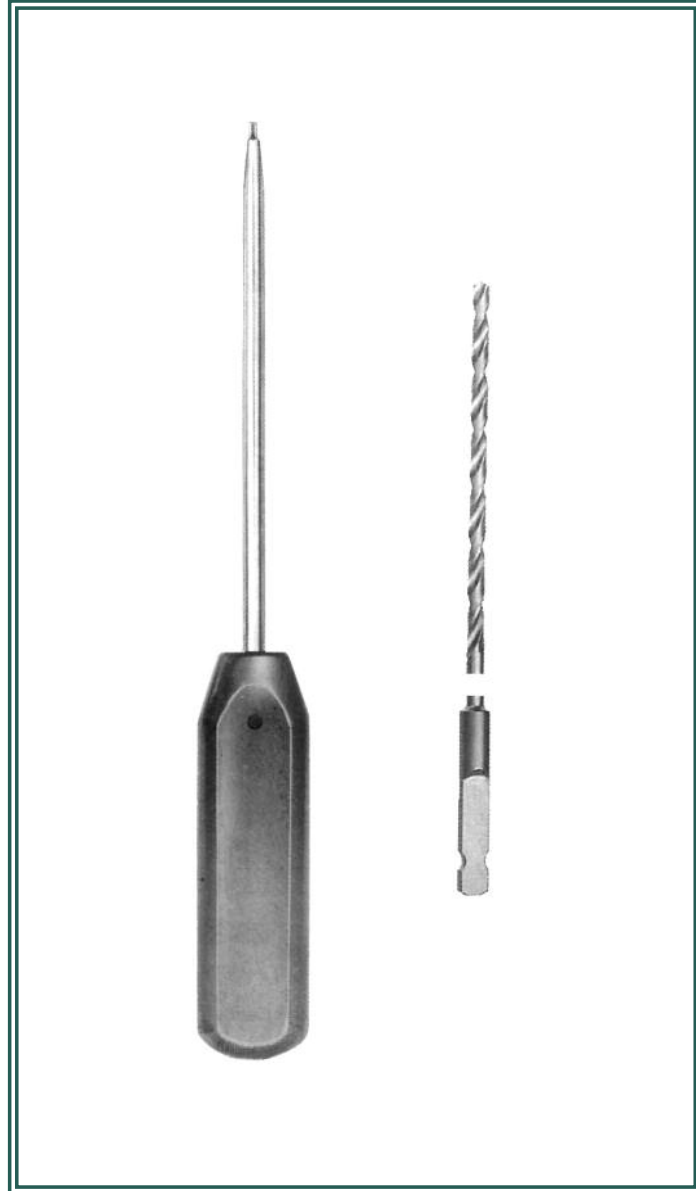

20

Drills/Screw Driver

Drills



round shaft			length mm	round shaft, long			length mm	quick coupling (AO)			length* mm	quadroangular shaft		length mm	triangular shaft		length mm
1,0	TR-3	0	56	TR-3	0	180		TR-3	1	60/ 35		TR-3	1	90			
1,1	TR-3	1	45														
1,2	TR-3	2	65														
1,5	TR-3	5	70	TR-3	5	180		TR-3	5	85/ 60		TR-3	5	105			
1,8	TR-3	8	80														
2,0	TR-3	0	85	TR-3	0	180		TR-3	0	100/ 75		TR-3	0	115			
2,0								TR-3	1	125/100							
2,2	TR-3	2	90														
2,5	TR-3	5	95	TR-3	5	180		TR-3	4	180/155		TR-3	5	115			
2,5								TR-3	5	110/ 85							
2,5								TR-3	6	125/100							
2,7	TR-3	7	100	TR-3	7	180		TR-3	7	100/ 75		TR-3		115			
2,8												TR-3		115			
3,0	TR-3	0	100	TR-3	0	180						TR-3	0	145/120	TR-3	0	115
3,2	TR-3	2	106	TR-3	2	180						TR-3	2	145/120	TR-3	2	115
3,2								TR-3	3	195/170							
3,5	TR-3	5	112	TR-3	5	180		TR-3	5	110 / 85		TR-3	5	125			
3,5								TR-3	6	145/120							
3,5								TR-3	7	195/175							
4,0	TR-3	0	119	TR-3	0	180		TR-3		130							
4,5	TR-3	5	126	TR-3	5	180		TR-3	5	145/120							
4,5								TR-3		130							
4,5															TR-3	6	195/170
5,0	TR-3	0	132	TR-3	0	180									TR-3		180
6,0	TR-3	0	139	TR-3	0	180		TR-3	0	145/120					TR-3		180
7,0				TR-3	0	180									TR-3		180
8,0	TR-3	0	160	TR-3	0	180									TR-3		180
9,0				TR-3	0	180									TR-3		180
10,0				TR-3	9	180									TR-3		180

Screw Driver

-  5,0 mm
-  3,5 mm
-  2,5 mm
-  1,5 mm



1,5 mm **TR-3**
2,5 mm **TR-3**
3,5 mm **TR-3**
5,0 mm **TR-3**



17,0 cm **TR-3**



25,0 cm **TR-3**



25,0 cm **TR-3**



25,0 cm **TR-3**

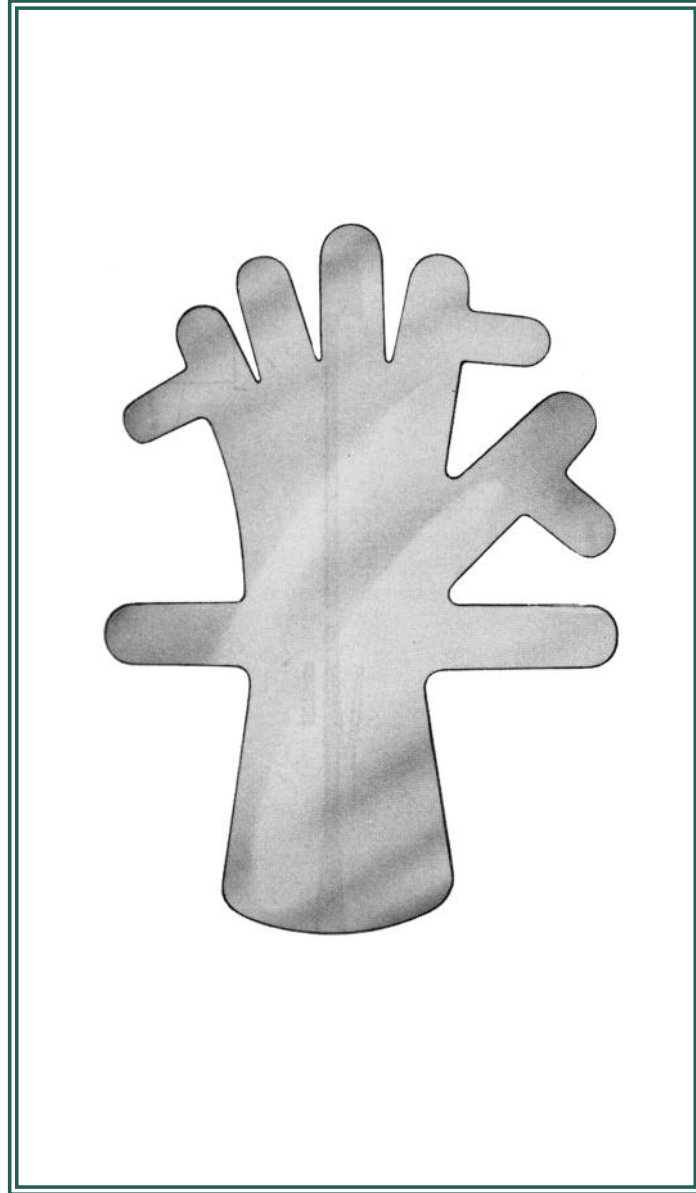

Hand/Foot Instruments



Feldheim
TR-36-210-00

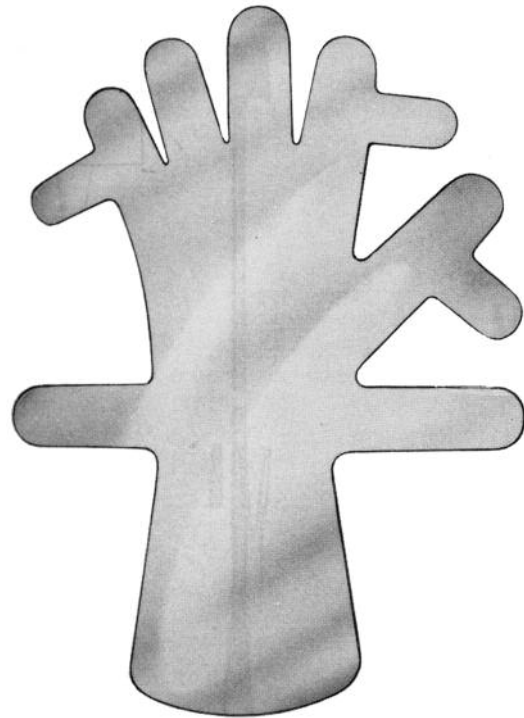

L d
foradults TR-36-212-00
forchildren TR-36-214-00

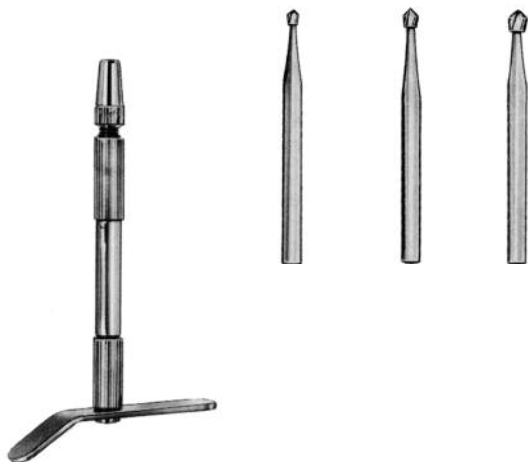

F □
TR-43-034-00



22

Bandage and Plaster Instruments

Bandage Scissors

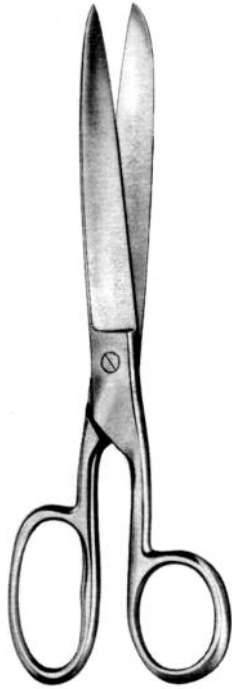

Smith
18,0 cm **TR-41-000-18**
20,0 cm **TR-41-000-20**

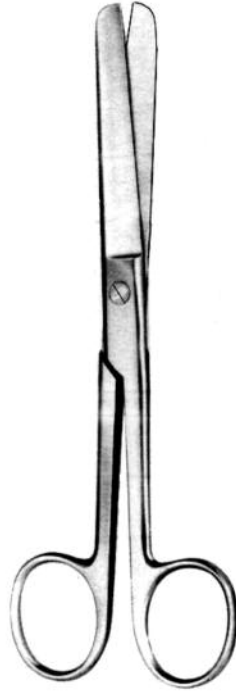

Lange
18,0 cm **TR-41-002-18**

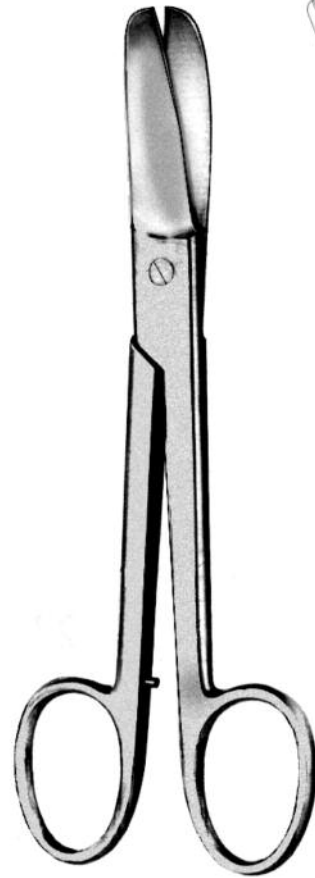

Lorenz
23,0 cm **TR-41-003-23**



Knowles
14,0 cm **TR-41-005-14**



Knowles
14,0 cm **TR-41-006-14**



Lister
9,0 cm **TR-41-007-09**
11,0 cm **TR-41-007-11**
14,0 cm **TR-41-007-14**
16,0 cm **TR-41-007-16**
18,0 cm **TR-41-007-18**
20,0 cm **TR-41-007-20**



Lister
14,0 cm **TR-41-007-14 L**
18,0 cm **TR-41-007-18 L**
20,0 cm **TR-41-007-20 L**

Left-hander

Bandage Scissors

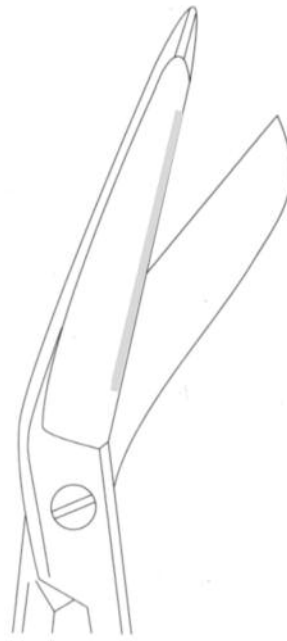

Lister, TC
18,0 cm TR-41-009-18

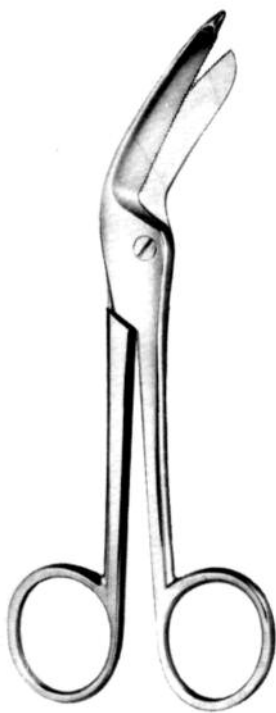

Lister, excentric
16,0 cm TR-41-011-16
18,0 cm TR-41-011-19

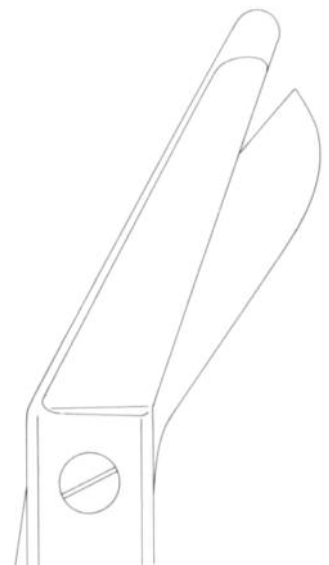
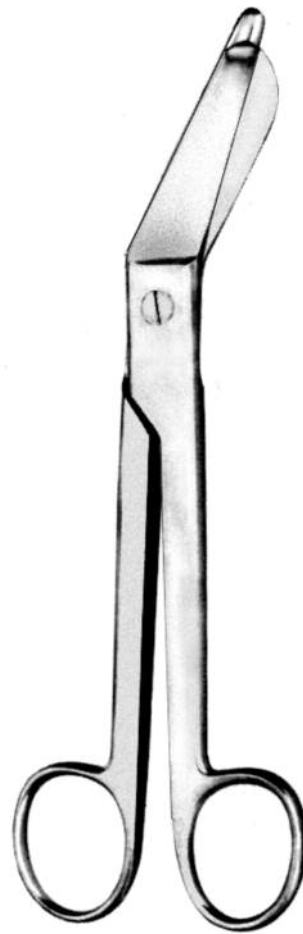

Esmarch
20,0 cm TR-41-013-20
23,0 cm TR-41-013-23

Bandage and Plaster Scissors

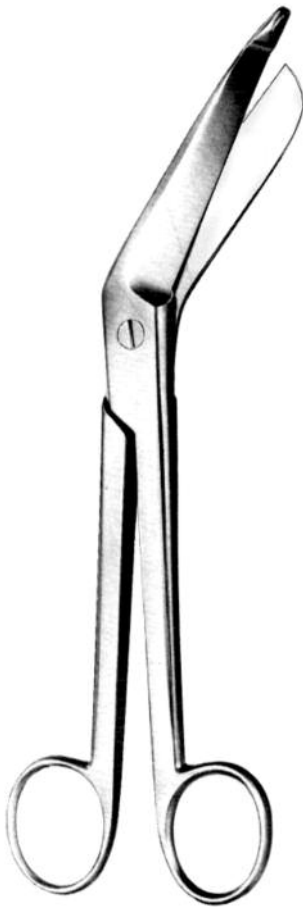

Bergmann
23,0 cm TR-41-015-23



Brun's
23,0 cm TR-41-017-23



Brun's
serrated
23,0 cm TR-41-017-24



Brun's
23,0 cm TR-41-019-23

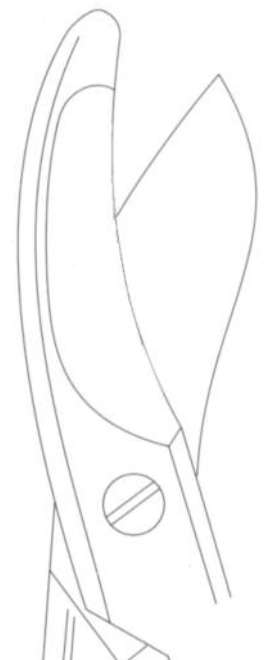

Bandage and Plaster Scissors



Universal, 15,0 cm

- 15,0 cm **TR-41-021-15** black
- 15,0 cm **TR-41-023-15** green
- 15,0 cm **TR-41-025-15** blue
- 15,0 cm **TR-41-027-15** red
- 15,0 cm **TR-41-029-15** yellow

Universal, 18,0 cm

- 18,0 cm **TR-41-021-18** black
- 18,0 cm **TR-41-023-18** green
- 18,0 cm **TR-41-025-18** blue
- 18,0 cm **TR-41-027-18** red
- 18,0 cm **TR-41-029-18** yellow



Plaster and Bandage Scissors
20,0 cm **TR-41-031-20**

Plaster Shears and Spreader

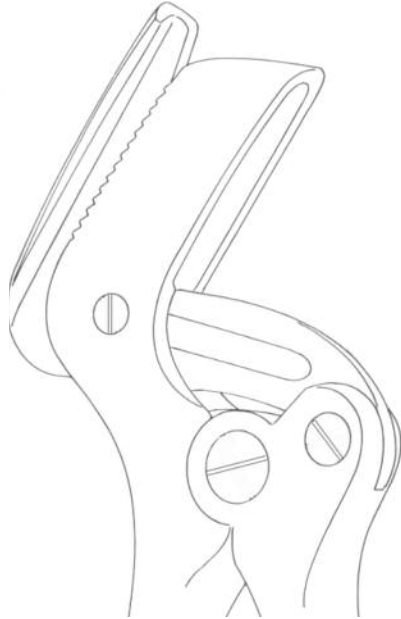

Stille

- 23,0 cm TR-41-033-23
- 26,0 cm TR-41-033-26
- 37,0 cm TR-41-033-37



Henning

- 28,0 cm TR-41-040-28

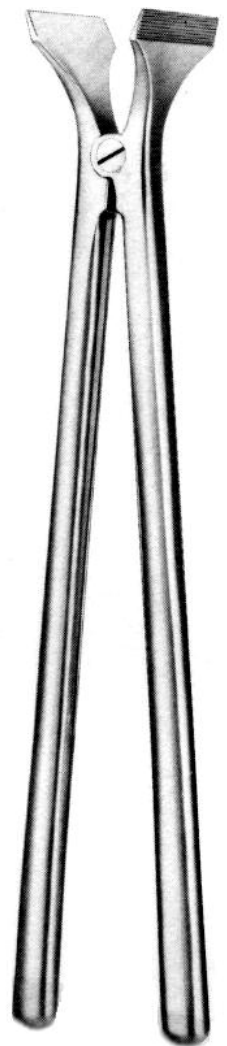

Beeson

- 30,0 cm TR-41-042-30

Plaster Instruments

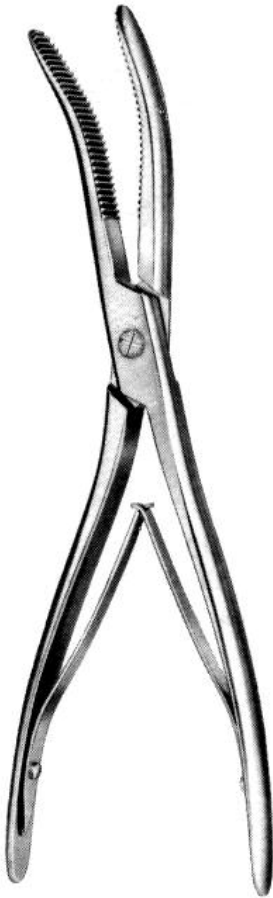

Wolff

Plaster Breakers

18,0 cm **TR-41-045-18**
24,0 cm **TR-41-045-24**



Engel

Plaster Saw

15,0 cm **TR-41-046-14**



Hopkins

20,0 cm **TR-41-048-20**



Esmarch

18,0 cm **TR-41-050-18**



Reiner

18,5 cm **TR-41-052-18**

Plaster Knives

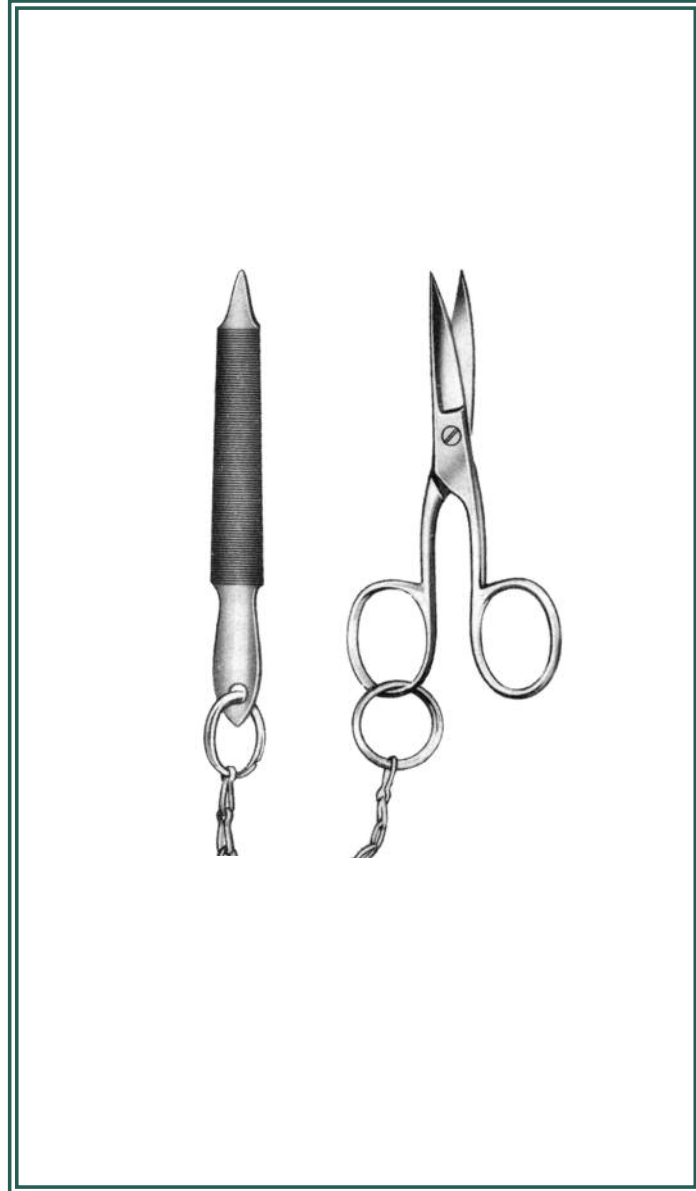

23

Nail Care Products

Nail Scissors, Nail Cutters



Baby-Nail scissors
8,5 cm **TR-43-005-08**



Nail scissors
9,0 cm **TR-43-006-09**
10,0 cm **TR-43-006-10**



Nail scissors
9,0 cm **TR-43-007-09**
10,0 cm **TR-43-007-10**

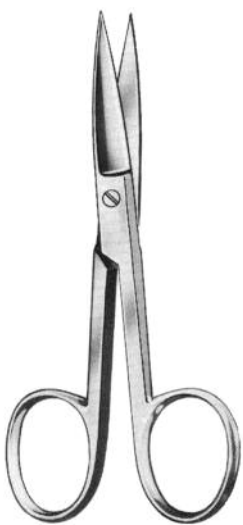

Nail scissors
9,0 cm **TR-43-008-09**
10,0 cm **TR-43-008-10**



Nail scissors
9,0 cm **TR-43-009-09**
10,0 cm **TR-43-009-10**



Nail scissors
9,0 cm **TR-43-014-09**

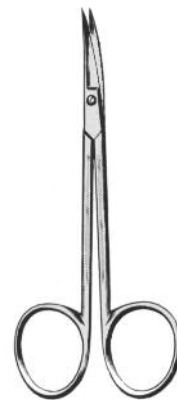

Nail scissors
9,0 cm **TR-43-015-09**



Nail cutter
10,5 cm **TR-43-018-02**

Skin Nippers, Nail Cutters, Nail Extracting Forceps, Files

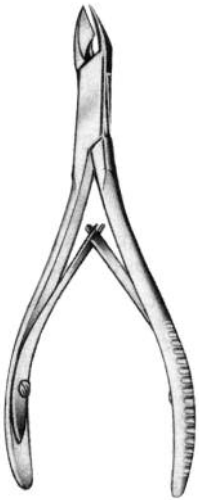

Hautzange
Skin Nipper

11,0 cm **TR-43-021-11**
13,0 cm **TR-43-021-13**



Nail cutter with spring
12,0 cm **TR-43-022-12**



Nail cutter with spring
11,0 cm **TR-43-023-11**
13,0 cm **TR-43-023-13**



Turnbull
Nail cutter with spring
11,0 cm **TR-43-024-11**
13,0 cm **TR-43-024-13**



Nail cutter with spring
14,0 cm **TR-43-025-14**



Nail cutter with spring
14,0 cm **TR-43-026-14**



Radolf
Nail extracting forceps
13,0 cm **TR-43-030-13**



File
10,0 cm
TR-43-032-10



File
12,0 cm
TR-43-032-12

Files, Finger Nail Drill, Nurses Set, Callus Plane



File
11,0 cm **TR-43-033-11**

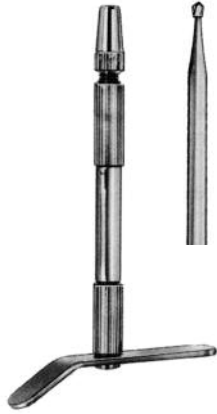

Finger nail drill, inclusive 3 drill points
TR-43-034-00



Schwesterngarnitur, 2-teil., komplett
Nail scissors and file, Set
TR-43-040-00



Credo
Hornhauthobel, Kunstst.-Griff
Callus plane
TR-43-050-00

Spare blades/pack = 10 pcs.
TR-43-050-01



Ralk
Splinter forceps
15 cm



TR-43-054-15



TR-43-055-15



Peet
Splintter forceps
11,5 cm **TR-43-057-11**

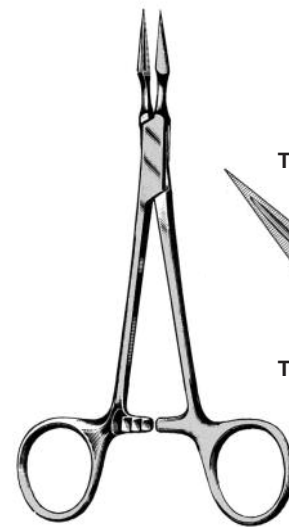

Stieglitz
Splinter forceps
13,5 cm



TR-43-058-13

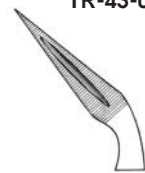

TR-43-059-13

Sterilizing forceps



Davis

Sterilizing forceps

- 16,0 cm **TR-43-060-16**
- 20,0 cm **TR-43-060-20**
- 24,0 cm **TR-43-060-24**



Cheatle

Sterilizing forceps

- 28,0 cm **TR-43-061-28**

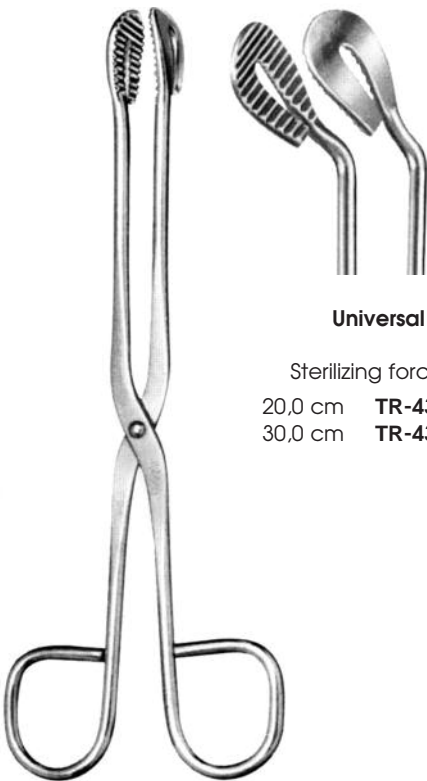

Universal

Sterilizing forceps

- 20,0 cm **TR-43-063-20**
- 30,0 cm **TR-43-063-30**

Universal

- Sterilizing forceps
- 20,0 cm **TR-43-062-20**
- 30,0 cm **TR-43-062-30**

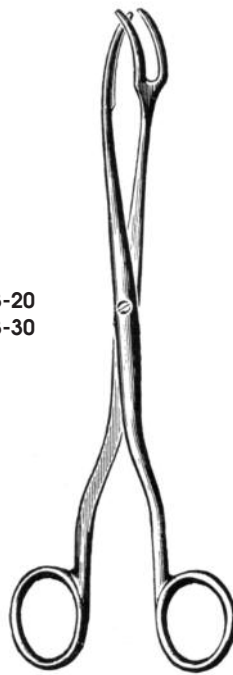

Sterilizing forceps

- 20,0 cm **TR-43-064-20**
- 30,0 cm **TR-43-064-30**



Sterilizing forceps

- 23,0 cm **TR-43-066-23**

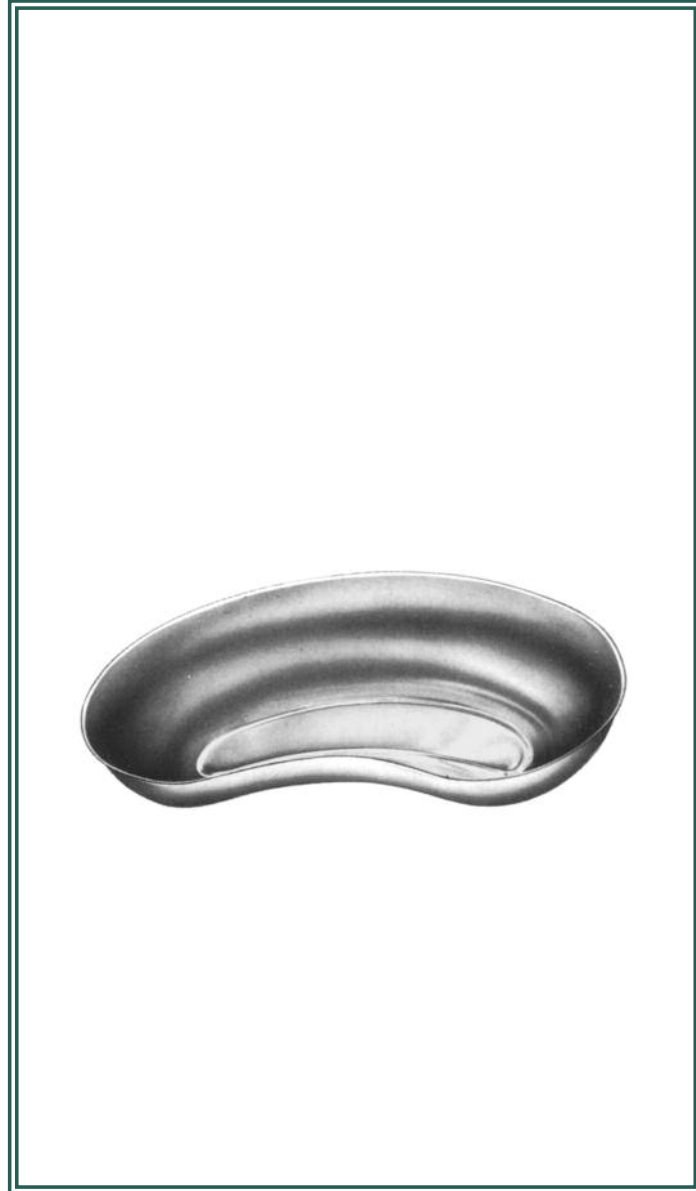

24

Bowles, Dishes, Boxes

Bowls, Dishes, Boxes

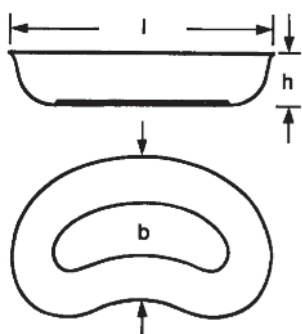

l x b x h		
170x100x35 mm	TR-45-100-17	
250x140x40 mm	TR-45-100-25	
270x150x40 mm	TR-45-100-27	

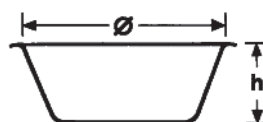

Ø	h	
150 mm,	70 mm	TR-45-101-16
160 mm,	65 mm	TR-45-101-17
220 mm,	80 mm	TR-45-101-22
277 mm,	115 mm	TR-45-101-27



Ø	h	
85 mm,	35 mm	TR-45-102-08
95 mm,	50 mm	TR-45-102-09
105 mm,	60 mm	TR-45-102-10
130 mm,	70 mm	TR-45-102-13



Ø	h	
40 mm,	19 mm	TR-45-103-04
61 mm,	30 mm	TR-45-103-06
80 mm,	40 mm	TR-45-103-08
116 mm,	50 mm	TR-45-103-11
128 mm,	55 mm	TR-45-103-12
147 mm,	65 mm	TR-45-103-14
167 mm,	75 mm	TR-45-103-16
187 mm,	85 mm	TR-45-103-18



Ø	h	
116 mm,	35 mm	TR-45-105-11
128 mm,	38 mm	TR-45-105-12
147 mm,	40 mm	TR-45-105-14
157 mm,	45 mm	TR-45-105-15
187 mm,	45 mm	TR-45-105-18

Bowls, Dishes, Boxes

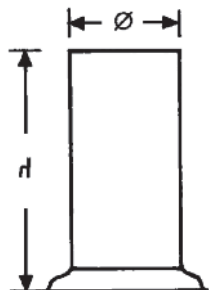

Ø	h	
30 mm	90 mm	TR-45-107-01
50 mm	100 mm	TR-45-107-02
50 mm	130 mm	TR-45-107-03
50 mm	175 mm	TR-45-107-04
75 mm	100 mm	TR-45-107-05
75 mm	130 mm	TR-45-107-06
75 mm	175 mm	TR-45-107-07
100 mm	175 mm	TR-45-107-08
100 mm	200 mm	TR-45-107-09

Lid, only



Ø	
50 mm	TR-45-107-50
75 mm	TR-45-107-75
100 mm	TR-45-107-98

Lid with opening



Ø	
50 mm	TR-45-107-51
75 mm	TR-45-107-76
100 mm	TR-45-107-99



graduated

0,025 l	TR-45-109-01
0,050 l	TR-45-109-02



Metal Cup
TR-45-110-09



Containers for cotton, pellets

with lid		
Ø	h	
75 x 60 mm		TR-45-111-01
75 x 75 mm		TR-45-111-02
100 x 60 mm		TR-45-111-03
100 x 100 mm		TR-45-111-04
125 x 80 mm		TR-45-111-05
125 x 125 mm		TR-45-111-06
150 x 150 mm		TR-45-111-07



Containers for cotton, pellets

without lid		
Ø	h	
75 x 60 mm		TR-45-111-11
75 x 75 mm		TR-45-111-12
100 x 60 mm		TR-45-111-13
100 x 100 mm		TR-45-111-14
125 x 80 mm		TR-45-111-15
125 x 125 mm		TR-45-111-16
150 x 150 mm		TR-45-111-17

Bowls ,Dishes, Boxes



- 0,10 l **TR-45-114-10**
- 0,25 l **TR-45-114-13**
- 0,50 l **TR-45-114-14**
- 1,00 l **TR-45-114-15**
- 2,00 l **TR-45-114-16**

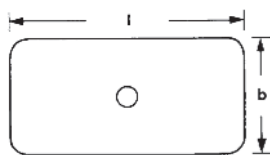
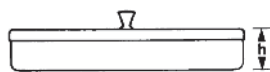

Lid with knob

l x b x h

- 165 x 85 x 35 mm **TR-45-122-01**
- 200 x 100 x 35 mm **TR-45-122-02**
- 200 x 100 x 50 mm **TR-45-122-03**
- 230 x 130 x 50 mm **TR-45-122-04**
- 230 x 150 x 50 mm **TR-45-122-05**
- 270 x 235 x 50 mm **TR-45-122-06**
- 300 x 200 x 50 mm **TR-45-122-07**
- 375 x 275 x 50 mm **TR-45-122-08**

Lid without knob

l x b x h

- 165 x 85 x 35 mm **TR-45-124-01**
- 200 x 100 x 35 mm **TR-45-124-02**
- 200 x 100 x 50 mm **TR-45-124-03**
- 230 x 130 x 50 mm **TR-45-124-04**
- 230 x 150 x 50 mm **TR-45-124-05**
- 270 x 235 x 50 mm **TR-45-124-06**
- 300 x 200 x 50 mm **TR-45-124-07**
- 375 x 275 x 50 mm **TR-45-124-08**

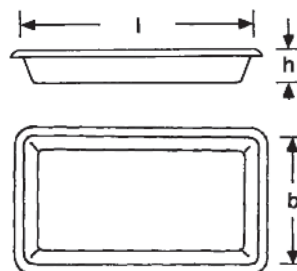

l x b x h

- 230 x 155 x 30 mm **TR-45-126-01**
- 300 x 175 x 30 mm **TR-45-126-02**
- 300 x 175 x 40 mm **TR-45-126-03**
- 350 x 240 x 36 mm **TR-45-126-04**
- 400 x 300 x 40 mm **TR-45-126-05**



l x b x h

- 210 x 160 x 10 mm **TR-45-128-01**
- 240 x 180 x 10 mm **TR-45-128-02**
- 310 x 150 x 10 mm **TR-45-128-03**
- 310 x 210 x 10 mm **TR-45-128-04**
- 350 x 240 x 10 mm **TR-45-128-05**
- 400 x 270 x 10 mm **TR-45-128-06**
- 420 x 280 x 10 mm **TR-45-128-07**

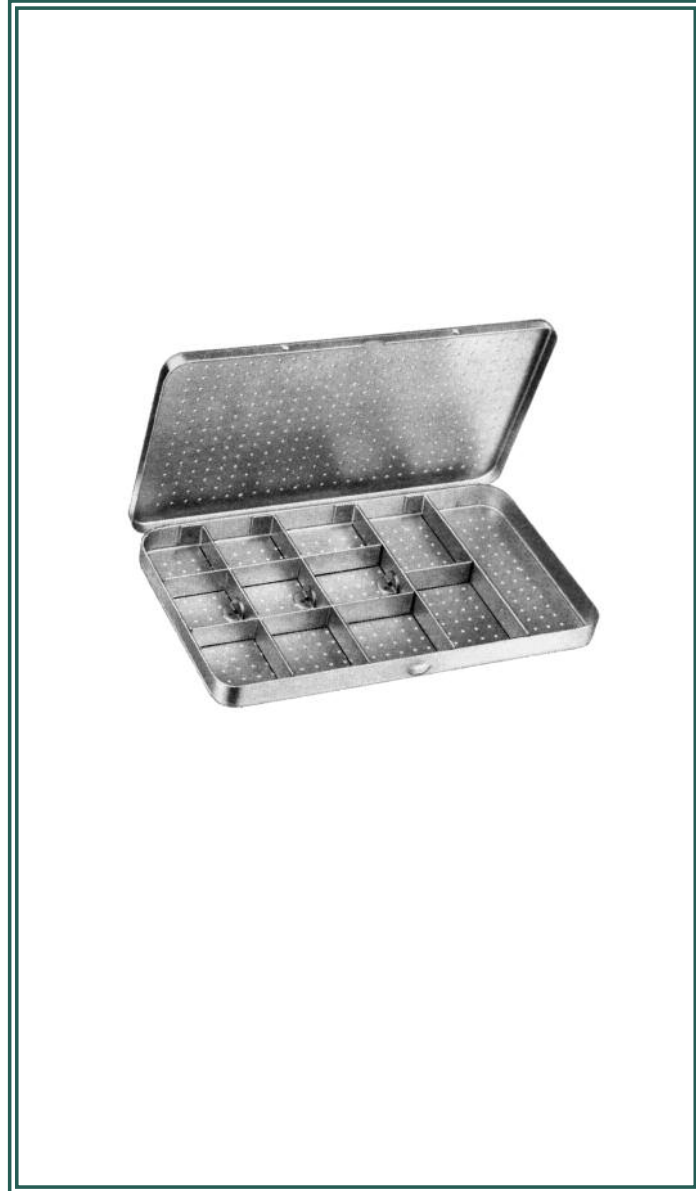

25

Sterilization

Sterilization



Needle case, complete	Ø 65 x 15 mm	TR-47-100-00
Exterior box, only	Ø 65 x 15 mm	TR-47-100-64
Interior box, only	Ø 62 x 15 mm	TR-47-100-65

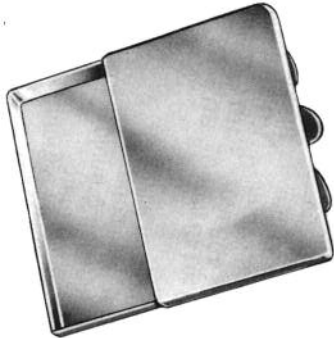

ungelocht
Needle case

50x25x5 mm	TR-47-102-01
65x40x8 mm	TR-47-102-02
75x25x5 mm	TR-47-102-03
70x55x9 mm	TR-47-102-04



gelocht
Needle case, perforated

50x25x5 mm	TR-47-102-11
65x40x8 mm	TR-47-102-12
75x25x5 mm	TR-47-102-13
70x55x9 mm	TR-47-102-14



ungelocht
Needle case

150x95x13 mm TR-47-110-01



gelocht

Needle case perforated
150x95x13 mm TR-47-110-02



ungelocht
Needle case

150x95x13 mm TR-47-112-01



gelocht

Needle case perforated
150x95x13 mm TR-47-112-02

Drilling Chucks, Cerclage Instruments



Sauerbruch
Needle case, perforated
210x125x17 mm **TR-47-120-00**



Sterilbehälter mit Kornzange
Dressing Forceps in jar
25,0 cm **TR-47-200-25**



Sterilizing Box

230x130x50 mm **TR-47-300-01**
260x150x50 mm **TR-47-300-02**
275x235x50 mm **TR-47-300-03**
300x200x50 mm **TR-47-300-04**
325x275x50 mm **TR-47-300-05**
420x175x50 mm **TR-47-300-06**

230x130x75 mm **TR-47-302-01**
260x150x75 mm **TR-47-302-02**
275x235x75 mm **TR-47-302-03**
300x200x75 mm **TR-47-302-04**
325x275x75 mm **TR-47-302-05**
420x175x75 mm **TR-47-302-06**



Textile Filters

230x130 mm (10 Stück) **TR-47-304-01**
260x150 mm (10 Stück) **TR-47-304-02**
275x235 mm (10 Stück) **TR-47-304-03**
300x200 mm (10 Stück) **TR-47-304-04**
325x275 mm (10 Stück) **TR-47-304-05**
420x175 mm (10 Stück) **TR-47-304-06**



Deponette
Perforated bottom

245x135x35 mm **TR-47-399-35**
245x135x50 mm **TR-47-399-50**
245x135x60 mm **TR-47-399-60**

A	
Abortuslöffel	465
Abortuszangen	464, 465
Abraham Tonsillennmesser	22
Abraham Tonsillennmesser	314
Absaugküretten	453, 454
Abszeßmesser	23
Adlerkreuz Pinzetten	103
Adson Bohrer	555
Adson Klemmen	128, 134
Adson Nadelhalter	256
Adson Nervhaken	299
Adson Pinzetten	95, 100, 105, 119-121, 128, 134
Adson Raspatorien	510
Adson Saugrohr	35
Adson Wundsperrer	235, 237, 238
Adson-Brown Pinzetten	105, 121
Agnew Parazentesenadel	352
Alexander Biopsiezange	458
Alexander Flachmeißel	499
Alexander Hohlmeißel	500
Alexander Raspatorium	512, 513
Allis Organfasszangen	188, 189
Allis-Adair Fasszangen	189
Allison Lungenspatel	383
Allis-Thoms Fasszangen	188
Alm Wundsperrer	231
Amniotom	449
Amputation	489-493
Amputationsmesser	18
Anal Spreizer	424
Anastomosenklemmen	418-420
Anatomische Pinzetten	93-97
Anderson-Adson Wundsperrer	235
Anlegezange f. Bulldogklemmen	151
Anlegezangen f. Clips	292, 293
Anuskope	423
Aorta Dilatatoren	392
Applikationsinstrument	360
Arruga Nadelhalter	259
Arterienklemmen	125-134
Ash Septumzange	338
Atraumatische Bulldog Klemmen	150, 153
Atraumatische Klemmen	148, 154-180
Atraumatische Pinzetten	106-107
Atriumhaken	397
Aufricht Nasenretraktor	335
Aufricht Raspeln	521
Austin Pinzetten	112
Auvard Scheidenspekula	442
Ayre Myommesser	21

A	
Abdominal Retractors	.240-251
Abdominal Spatulas	.217-219
Abraham Tonsil Knife	.22, 314
Abscess Knife	.23
Adenoid Curettes	.317
Adenotomes	.317
Adlerkreuz Forceps	.103
Adson Drill Bit	.555
Adson Forceps	.95, 100, 105, 119-121, 128, 134
Adson Needle Holders	.256
Adson Nerve Hooks	.299
Adson Raspatories	.510
Adson Retractors	.235, 237, 238
Adson Suction Tube	.35
Adson-Brown Forceps	.105, 121
Agnew Myringotome	.352
Air Bag	.345
Alexander Biopsy Forceps	.458
Alexander Chisel	.499
Alexander Gouges	.500
Alexander Raspatory	.512, 513
Allis Grasping Forceps	.188, 189
Allis-Adair Grasping Forceps	.189
Allison Lung Spatulas	.383
Allis-Thoms Grasping Forceps	.188
Alm Retractors	.231
Amniotome	.449
Amputating Knives	.18
Amputation	.489-493
Anastomosis Clamps	.418-420
Anderson-Adson Retractors	.235
Anuscopes	.423
Aortic Dilators	.392
Applicators	.360
Applying Forceps	.292, 293
Arruga Needle Holders	.259
Ash Septum Forceps	.338
Aspirating Curettes	.453, 454
Atraumatic Bulldog Clamps	.150, 153
Atraumatic Forceps	.106-107, 148, 154-180
Atrium Retractors	.397
Aufricht Nasal Retractor	.335
Aufricht Rasps	.521
Austin Forceps	.112
Autopsy Knives	.20
Auvard Vaginal Specula	.442
Ayre Myotome	.21
B	
Babcock Grasping Forceps	.187
Babinsky Percussion Hammer	.3
Baby-Kocher Intestinal Clamps	.409
Backhaus Towel Forceps	.190
Bahnson Forceps	.160
Bailey Rib Contractors	.382
Bakes Gall Duct Dilators	.429
Balfour Retractors	.246, 247
Ballenger Holding Forceps	.184
Ballenger Swivel Knives	.332
Ballenger Tonsil Forceps	.312
Bandage and Plaster Instruments	.569 – 577
Bandage Scissors	.571 – 574
Barraquer Forceps	.110
Barraquer Needle Holders	.261, 288
Barth Bone Curettes	.348
Baumgartner Needle Holders	.256, 277
Beacham Amniotome	.449
Beck Forceps	.158
Beckmann Adenoid Curettes	.317
Beckmann Nasal Specula	.325
Beckmann Retractors	.238, 239
Beebe Scissors	.74
Beer Forceps	.110
Beeson Plaster Spreader	.575
Belucci Ear Scissors	.356, 357
Bengolea Forceps	.127, 133
Bergmann Bandage Scissors	.573
Bergmann Scalpels	.14
Berliner Percussion Hammer	.3
Bernhard Towel Forceps	.190
Berillon Cephalometer	.5
Bethune Rib Shears	.369
Betram Towel Forceps	.191
Beuse Scissors	.55
Beyer Bone Rongeurs	.539
Biemer Vessel Spreader	.399
Billeau Ear Loops	.348
Biopsy Forceps	.426, 456-458
Bircher Meniscus Knifes	.546
Bircher-Ganske Forceps	.545
Birkett Forceps	.140
Bishop Lip Retractor	.311
Bladder Retractors	.240
Blade Breakers	.12, 398
Blade Holders	.12, 398
Blake Embolus Grasping Forceps	.396
Blake Gall Stone Forceps	.432
Blakesley Nasal Forceps	.340
Blohmke Tonsil Forceps	.312
Blount Bone Levers	.519
Blount Meniscus Retractors	.547
Blumenthal Bone Rongeurs	.537
Böhler Bon Rongeurs	.538
Böhler Bone Cutting Forceps	.543
Böhler Wire Traction Bow	.549
Bone Curettes	.525-528
Bone Cutting Forceps	.542-544
Bone Holding Forceps	.529-535
Bone Levers	.516-520
Bone Rongeurs	.536-541
Bone Scissors	.367-370
Bone Surgery	.475-555
Bonn Scissors	.61
Bonney Forceps	.103, 120, 121
Bose Trachea Retractors	.321
Böttcher Scissors	.56
Bowel Scissors	.48
Bowls	.585 – 589
Bowman Probes	.27
Boxes	.585 – 589
Boys-Allis Grasping Forceps	.189
Bozemann Dressing Forceps	.182
Bozemann Needle Holders	.258, 279
Brain Clip Carrier	.292
Brain Spatula	.291
Brainbridge Forceps	.129, 162
Brand Tendon Seizing Forceps	.548
Braun Tenaculum Forceps	.448, 451
Braun Uterine Depressor	.447
Braun-Stadler Scissors	.47
Breisky Vaginal Specula	.441
Brian Knife	.20
Brodie Director	.27
Brom Retractors	.230
Broncho-Esophagos Forceps	.323
Bronchus Forceps	.149
Brophy Forceps	.97, 102
Brown Forceps	.104
Brünings Laryngology Tips	.320
Brünings Septum Forceps	.337
Brünings Septum Knife	.328

TRS INSTRUMENTS

Brünings Tongue Depressor	307	Collin Mallet	495
Brünings Tonsil Knife	22, 314	Collin Pelvimeter	461
Brünings Tonsil Snare	314	Collin Retractors	214, 216, 241-243
Brünings Tubes	320	Collin Suture Forceps	269
Brunner Guiding Probes	266, 267	Collin Umbilical Cord Clamp	463
Brunner Rectal Clamps	419	Collin Uterine Forceps	452
Brunner Retractors	204	Collin Vaginal Specula	435
Brunner Rib Shears	370	Columella Tissue Forceps	335
Bruns Bone Curettes	525, 528	Comedone Extractors	26
Bruns Plaster Scissors	573	Conchotomes	484
Buck Ear Curettes	348	Conductor	296
Buck Foreign Body Instrument	350	Converse Nasal Retractor	335
Buck Percussion Hammer	3	Converse Septum Knife	329
Buck Scissors	73	Cooley Atrium Retractors	397
Buelau Trocar	31	Cooley Dilator	392
Bulldog Clamps	150-153	Cooley Forceps	107, 176-180
Bunnell Hand Drill	555	Cooley Rib Spreaders	371, 380
Burford Rib Spreaders	374	Cooley Scalpel Holder	398
Burrs	555	Cooley Suction Tubes	37
Busch Umbilical Scissors	48	Cooley Vascular Dilators	391
Bushe Bone Curettes	527	Cooley-De Bakley Forceps	173
C		Cooper Ligature Needles	263
Caliper	6	Cordes Laryngology Tips	320
Callus Plane	583	Coronar Scissors	63
Caplan Septum Scissors	339	Corwig-Hegar Twisting Forceps	551
Cardiovascular Instruments	387-405	Coryllos Bone Rongeurs	541
Carmalt Forceps	111	Coryllos Retractors	203
Carmalt Forceps	128	Cottle Bone Crusher	335
Caroll Goniometer	5	Cottle Bone Cutting Forceps	542
Carotis Clamps	153	Cottle Chisel	500
Carpenter Dissectors	313	Cottle Elevators	331
Cartilage Knives	19	Cottle Mallet	494
Cartilage Seizing Forceps	545	Cottle Nasal Retractors	335, 336
Caspar Retractors	301	Cottle Nasal Specula	326
Caspar Rongeurs	487	Cottle Osteotomes	333
Caspar Suture Pusher	400	Cottle Raspatory	510
Cast Bandage Scissors	572	Cottle Scissors	56, 86
Castaneda Forceps	154	Cottle Septum Knives	329
Castaneda Rib Spreaders	372	Cottle Tissue Forceps	335
Castroviejo Needle Holders	260, 288	Cottle-Walsham Septum Forceps	338
Castroviejo Scissors	66	Cotton Applicators	27-29
Catheter Forceps	469	Crafoord Forceps	138
Catheter Introducer	473	Crafoord Scissors	47
Catlin Amputating Knife	18	Craig Septum Forceps	337
Cephalometer	5	Credo Callus Plane	583
Cerclage Instruments	550	Crile Forceps	129, 130, 134
Cerclage Wire	550	Crile Retractors	216, 223
Cerny Rectal Speculas	422	Crile-Murray Needle Holders	256
Cerny Tenaculum Forceps	451	Crile-Wood Needle Holder	256, 276
Chaput Grasping Forceps	189	Crutchfield Skull Traction Tongs	294
Charrière Amputation Saws	491, 492	Curettes	360
Cheatle Sterilizing Forcpes	584	Cusco Vaginal Specula	435
Chest Support	311	Cushing Brain Spatula	291
Chevalier Rib Spreader	376	Cushing Flat Drill	555
Chisels	498-509	Cushing Forceps	97, 102, 119
Church Scissors	62	Cushing Hooks	223, 227, 228, 229
Cilia and Splinter Forceps	110-111	Cushing Nerve Hook	299
Cinelli Osteotomes	334	Cushing Punches	482
Citelli Punches	477	Cushing Raspatories	514
Citelli-Beyer Punches	477	Cushing Retractors	230
Classon Scissors	62	Cushing Rongeurs	486
Cleveland Bone Cutting Forceps	542	Cushing-Brown Forceps	104
Cleveland Bone Rongeurs	537	Cushing-Landolt Spreader	304
Cloward Wound Spreader	302-304	Cutter for wires and screws	554
Coagley Antrum Curettes	336	Cuzzi Ovum Curettes	465
Coakley Trocar	32	D	
Collier Needle Holders	257	Dahlgren Skull Punch	295
Collin Dynamometer	5	Dale Forceps	171, 172
Collin Grasping Forceps	185, 186	Dandy Forceps	130, 134
Collin Holding Forceps	311	Dandy Nerve Hook	299

Dandy Scissors62	Drilling Chuck550
Dardik Forceps180	Dubois Scissors47
Darligues Uterine Forceps452	Duehrssen Forceps104
Daubenspeck Bone Curettes527	Duke Trocar32
Davidson Retractors213	Duplay Tenaculum Forceps448
Davis Dissector395	Duplex Stethoscopes4
Davis Sterilizing Forceps584	Dupuy-Weiss Suture Needles316
Davis-Boyle Mouth Gag309	Dura Dissectors296, 297, 393, 395
Davis-Boyle Tongue Blades310	Dura Knife23, 298
Day Ear Hooks349	Duval Forceps98
De Bakey Forceps	106-107, 121, 148, 153-175	Duval Grasping Forceps185, 186
De Bakey Needle Holders275	Dynamometer5
De Bakey Rib Spreaders378, 379		
De Bakey Scissors64, 89	E	
De Bakey Vascular Dilators391	Ear and Nose Forceps	108-109
De Martel Conductor296	Ear Catheters345
De Martel-Wolfson Clamps418	Ear Curettes348, 349
De Vilbiss Skull Punch295	Ear Elevators353
Dean Scissors56, 86	Ear Hooks349, 350
Deaver Retractors220, 221	Ear Instruments341-363
Deaver Scissors43	Ear Loops349
Dejardins Gall Duct Dilators429	Ear Polypus Forceps350, 351
Dejardins Gall Stone Scoops430	Ear Rasparories353
Dejerine Percussion Hammers3	Ear Snares353
Delicate Surgical Scissors58-61, 88	Ear Specula347
Demel Wire Guide550	Ear Syringes346
Demel Wire Tightener Forceps550	Eastman Retractors212
Denhardt Mouth Gag308	Eaton Retractors239
Dennis-Brown Retractors248	Echlin Bone Rongeurs539
Deponettes594	Eiselsberg Scissors73
Derff Needle Holders257, 278	Elevators516, 517
Dermal Punch25	Endospecula443
Dermatomes24	Engel Plaster Saw576
Derri Forceps158, 178	ENT Instruments305-363
Deschamps Ligature Needles264, 265	Eppendorf Biopsy Forceps458
Desjardins Forceps146, 432	Esmarch Bandage Scissors572
Desmarres Hooks226, 227	Esmarch Plaster Knives576
Dieffenbach Clamps151	Eves Tonsil Snares314
Dieffenbach Scalpels15	Exploration Hooks403
Dieter Ear Forceps357, 358		
Diethrich Clamps151, 174	F	
Dietrich Needle Holders287	Farabeuf Bone Holding Forceps531
Dilating Bougies472	Farabeuf Raspatories512
Dingmann Bone Holding Fcps.530	Farabeuf Retractors215
Dingmann Mouth Gag309	Farabeuf-Collin Raspatories512
Dingmann Tongue Blades310	Farrell Cotton Applicators28
Directors27	Faure Biopsy Forceps456
Discision Knives359	Faure Forceps144
Dishes585 – 589	Favaloro Scissors63
Dissecting Forceps136-138, 145, 146	Fehland Anastomosis Clamps420
Dissecting Scissors50-55, 82-85	Feichenfeld Forceps111
Dissectors296, 313, 360, 393, 395, 401	Ferguson Vaginal Specula437
Dittel Dilating Bougies472	Fergusson Bone Holding Fcps.531
Dixon-Lovelace Forceps129, 134	Fergusson Scissors44
Dockhorn Retractors200	Fergusson Suction Tubes35
Douglas Forceps110	Ferris-Smith Forceps103
Douglas Trocar32	Ferris-Smith-Cushing Punches482
Doyen Director27	Ferris-Smith-Kerrison Punches479-481
Doyen Holding Forceps183	Ferrozell Mallets494-497
Doyen Intestinal Clamps409, 411	Files521-524, 582, 583
Doyen Mallets495	Filter, textile594
Doyen Myoma Screws452	Finger Nail Drill583
Doyen Retractors206, 208	Finger Ring Saws493
Doyen Scissors44	Finochietto Forceps145
Doyen Vaginal Specula440	Finochietto Rib Spreaders371, 372, 377
Doyen-Jansen Mouth Gag308	Finsen Retractors231
Dressing and Sponge Forceps181-186	Fioncchietto Needle Holders259, 280
Dressing Forceps93-97	Fisch Hooks360
Dressing Forceps in jar594	Fisher Tonsil Knife314
Drill Bits555, 563	Fistail Ostoetome500
Drill Points294	Fistula Knives21

Fixation Discs	.549	Gorney Scissors	.54
Flap Knife	.359	Gosset Retractors	.245
Flap Knives	.359	Gouges	.499-509
Flat Drills	.555	Gourdet Uterine Scoops	.459
Flat Nose Pliers	.551-554	Graefe Hooks	.223, 224
Fomon Osteotomes	.334	Graefe Scissors	.61
Fomon Rasps	.521	Graefe Tissue Forceps	.335
Fomon Scissors	.54, 56-57, 86	Graham Nerve Hook	.299
Fomon Septum Knife	.328	Grave Vaginal Specula	.436
Fomon Skin Hooks	.336	Gray Forceps	.145
Foot Instruments	.567	Green-Armytage Forceps	.463
Forceps	.92-121	Gregory Forceps	.171
Forceps, Clamps, Clips	.124-192, 335	Gregory-Soft Clamps	.153
Foreign Body Instruments	.350	Greven Wire Forceps	.356
Förster Holding Forceps	.184, 185	Gross Foreign Body Instrument	.349
Fowler Tonsil Knife	.22	Gross-Maier Dressing Forceps	.181
Fox Lupus Scraper	.25	Grünwald Forceps	.109
Fränkel Laryngeal Forceps	.319	Guiding Probes	.266-268
Fränkel Laryngology Tips	.320	Guyon Forceps	.147, 148
Franz Retractor	.250	Guyon Urethral Bougies	.471
Frazier Dissector	.297	Gynaecology Forceps	.142-144
Frazier Nerve Hook	.299	Gynecological Scissors	.45-49, 79-81
Frazier Suction Tubes	.35	Gynecology Instruments	.433-465
Freer Chisel	.332, 498		
Freer Elevatories	.329	H	
Freer Hooks	.229	Haemostatic Forceps	.125-134
Freer Muscosa Knives	.328	Haeney Forceps	.143
Freer Raspatories	.329	Haight Rib Spreaders	.375
Freer Vascular Spatula	.394	Hajek Nasal Forceps	.484
Frenzel Tongue Depressor	.307	Halle Bone Curette	.527
Friedmann Bone Rongeurs	.536	Halle Dura Knife	.23, 298
Friedmann Vaginal Spreader	.443	Halle Vascular Spatula	.394
Fritsch Retractors	.206	Halsey Needle Holders	.257, 277
Front Cutting Pliers	.553	Halsted-Mosquito Forceps	.127, 131, 134, 135
Frontal Sinus Bougies	.28	Hand Drills	.555
Frosch Bone Holding Forceps	.531	Hand/Foot Instruments	.567
Frykholm Bone Rongeurs	.540	Handles for Laryngeal Mirrors	.318
Fuchsig Forceps	.129	Hank Uterine Dilators	.446
Fuller Introduction Instrument	.357	Harken Forceps	.175
		Harrington Retractors	.210
G		Hartmann Bone Rongeurs	.537
Galea Hooks	.292	Hartmann Ear Catheter	.345
Gall Duct Dilators	.429	Hartmann Ear Hook	.349
Gall Stone Forceps	.432	Hartmann Ear Polypus Forceps	.350
Gall Stone Scoops	.430	Hartmann Ear Polypus Forceps	.351
Gallaher Rasps	.521	Hartmann Ear Specula	.347
Gardner Bone Cutting Forceps	.542	Hartmann Intestinal Clamps	.410
Gast Tongue Blades	.310	Hartmann Nasal Forceps	.484
Geissendörfer Forceps	.136	Hartmann Polypus Forceps	.327
Gelhorn Biopsy Forceps	.457	Hartmann Retractors	.214
Gelpi-Loktite Retractors	.236	Hartmann Tongue Depressor	.307
Gelpi-Seileitz Retractors	.236	Hartmann Tuning Forks	.343, 344
Gemini Forceps	.137, 138	Hartmann-Halle Nasal Specula	.324
Genito Urinary Instruments	.467-473	Harvey Scissors	.74
Gerald Forceps	.97, 102, 109, 120	Head Lights	.7
Gerald-Brown Forceps	.104	Head Mirrors	.7
Gerlach Micro Hooks	.361	Heaney Needle Holders	.257, 279
Gerster Bone Holding Clamp	.535	Heath Mallet	.495
Gibbon Rib Contractor	.382	Heermann Gouges	.363
Giertz Rib Shears	.370	Heermann Handle	.363
Gillies Forceps	.95, 101, 120	Heermann Mallet	.363
Gillies Hooks	.229	Hegar Needle Holders	.256, 274, 285
Gillies Needle Holders	.259, 281	Hegar Uterine Dilators	.444, 445
Gil-Vernet Hooks	.228	Hegar-Vascular Needle Holders	.285
Glegg Snare	.353	Hegemann-Diethrich Scissors	.65
Glover Clamps	.150, 163	Hegebarth Suture Forceps	.269
Gluck Rib Shear	.367	Heifetz Brain Spatula	.291
Goelet Retractors	.216	Heifetz Forceps	.115
Goldmann-Fox Scissors	.59, 87	Heiss Forceps	.127
Goniometer	.5	Heister Mouth Gag	.307
Good-Schwekendieck Scissors	.56	Hemorrhoidal Grasping Forceps	.425

Hemorrhoidal Ligator	425	Joseph Scissors	58, 87
Henke Dissectors	313	Joseph Septum Knives	328, 329
Henley Retractor	234	Judd-Allis Grasping Forceps	189
Henning Plaster Spreader	575	Jurasz Laryngeal Forceps	319
Herrick Forceps	148	K	
Heymann Polypus Forceps	327	Kabierske Powder Blower	346
Heymann Scissors	57	Kahler Laryngology Tip	320
Heymann Septum Forceps	337	Kallmorgen Vaginal Specula	439
Hibbs Chisel	503	Kane Umbilical Cord Clamp	463
Hibbs Gouges	504	Katsch Comedone Extractor	26
High Precision Instrument	489	Kelly Anuscopes	423
Hoer Dissectors	297	Kelly Forceps	130, 141
Hoer Raspatories	514	Kelly Grasping Forceps	183
Hohmann Bone Levers	518, 519	Kelly Retractors	208
Hoke Chisel	503	Kelly Scissors	58, 87
Holding Forceps	312	Kelly-Rankin Forceps	129
Holzheimer Retractors	231	Kern-Lane Bone Holding Fcps.	532
Hooks, fine	223-229	Kerrison Punches	478-481
Hopkins Plaster Knives	576	Kervorkian Aspirating Curette	453
Horsley Nerve Root Retractor	298	Kervorkian Biopsy Forceps	458
Hösel Needle Holders	283	Key Bone Cutting Forceps	544
Hösel Retractors	209	Keyes Dermal Punch	25
House Bone Curettes	363	Kidney Bowls	587
House Micro Needles	361	Kidney Pedicle Forceps	147, 148
House-Dieter Ear Forceps	357	Kidney Stone Forceps	431
Huber Universal Handle	320	Killian Elevators	330
Hudson Burrs	555	Killian Gouges	332
Hudson Hand Drill	555	Killian Nasal Specula	325
Hunt Forceps	114, 116	Killian Raspatories	510
Hunter Forceps	111	Killian Septum Scissors	339
Hurd Dissectors	313	Kilner Hooks	229
Hurd Ligature Needles	316	Kilner Nasal Retractors	335
Hypodermic Syringes	34	Kilner Needle Holders	278
Hysterectomy Forceps	143	Kilner Scissors	55, 85
Hysterectomy Scissors	81	Kilner-Doughty Mouth Gag	309
I		Kirschner Guiding Probes	266, 267
Inge Lamina Spreader	304	Kirschner Retractors	249
Interchangeable Blades	506	Kirschner Wire	559, 560
Intestinal Clamps	409-420	Kirschner Wire Traction Bow	549
Intestinal-/Stomach Suture Set	421	Kirschner wires dispenser	559
Iowa Tenaculum Forceps	450	Klapp Hooks	225
Iris Scissors	61, 88	Kleinert-Kutz Tendon Forceps	548
Israel Retractors	197	Klinkenbergh-Loth Scissors	62
Iverson Trachea Retractors	321	Knowles Bandage Scissors	571
Ives-Fansler Anoscope	423	Kocher Forceps	132
J		Kocher Intestinal Clamps	409, 410, 412, 413
Jackson Trachea Retractor	321	Kocher Retractors	195, 200, 201, 205, 207, 228
Jacobs Tenaculum Forceps	451	Kocher Trachea Directors	322
Jacobson Probes	399	Koerte Abdominal Spatulas	219
Jacobson Suture Pusher	400	Koerte Retractors	197
Jacobson Vessel Knives	405	Kogan Endospecula	443
Jameson Needle Holders	258	Kölnner Scalp Clips	292
Janet Hypodermic Syringes	34	König Elevators	516
Jansen Bone Curettes	348	König Guiding Probes	267
Jansen Bone Rongeurs	537, 539	König Hooks	227
Jansen Forceps	108	König Raspatory	509
Jansen Retractors	231	Koos Vessel Knives	405
Jansen Septum Forceps	339	Kraus Vessel Knives	405
Javid Forceps	172	Krause Laryngology Tips	320
Jennings Mouth Gag	308	Krause Polypus Snares	328
Jeweller Type Forceps	111	Krause Trocar	32
Jobson-Horne Cotton Applicator	28	Krause-Voss Polypus Snares	328
Johns-Hopkins Forceps	146, 151	Krayenbühl Vessel Hook	400
Jones Towel Forceps	191	Kressner Septum Forceps	338
Joseph Elevators	331	Kristeller Vaginal Specula	437-439
Joseph Hooks	229	Kronecker Ligature Needles	263
Joseph Nasal Saws	334	Krönlein Forceps	131
Joseph Raspatory	510	Kümmel Abdominal Spatulas	218
Joseph Rasps	521	Kümmel Retractors	206

L		
La Force Adenotomes	317	
La Grange Scissors	61	
Laborde Trachea Dilator	321	
Lahey Forceps	146	
Lahey Seizing Forceps	322	
Lahey Tenaculum Forceps	451	
Lambert-Kay Forceps	172	
Lamotte Bone Holding Forceps	534	
Lamotte Chisel	500, 502	
Lamotte Raspatories	512	
Lamina Spreaders	304	
Laminectomy Retractors	300-304	
Laminectomy Rongeurs	486-488	
Lancet Knives	359	
Landau Trocar	32	
Landau Vaginal Specula	441	
Landolt Rongeurs	488	
Landolt Scalpel Holder	398	
Landolt Scissors	57	
Landolt Spreader	304	
Lane Forceps	103	
Lane Stomach Clamps	416	
Lane Towel Forceps	191	
Lange Bandage Scissors	571	
Lange Foreign Hook	336	
Lange Laryngology Tip	320	
Langenbeck Amputating Knife	18, 490	
Langenbeck Amputation Saw	492	
Langenbeck Bone Holding Fcps.	531	
Langenbeck Ear Loop	348	
Langenbeck Elevators	516	
Langenbeck Needle Holders	284, 287	
Langenbeck Raspatories	512, 514	
Langenbeck Retractors	198, 199, 200, 215, 228	
Langenbeck Scalpels	19, 490	
Laryngeal Instruments	318-323	
Laryngeal Mirrors	318	
Laryngology Tips	320	
Laryngoscopes	8, 9	
Lawrence Forceps	137	
Lazar Forceps	112	
Lebsche Sternum Chisel	368	
Lees Forceps	163, 168	
Legueu Bladder Spatula	470	
Leksell Bone Rongeurs	540	
Leland Forceps	165	
Lempert Bone Curettes	526	
Lempert Bone Rongeurs	537	
Lempert Elevators	353	
Lempert Raspatories	353	
Lempert Snare	353	
Lerche Forceps	105	
Lerliche Abdominal Spatulas	218	
Lerliche Forceps	130, 134	
Lewin Bone Holding Forceps	529	
Lewis Rasps	521	
Lexer Chisel	507-509	
Lexer Scissors	53, 84	
Lexer-Mini Chisel	507	
Lichtenberg Needle Holders	283	
Lichtwitz Trocar	31	
Ligature Adjusters	268	
Ligature Carrying Forceps	469	
Ligature Catcher	268	
Ligature Needles	263-266	
Ligature Scissors	73, 74, 90	
Lip Retractor	311	
Lister Bandage Scissors	571, 572	
Lister Sinus Forceps	181	
Liston Amputating Knife	18	
Liston Bone Cutting Forceps	542-544	
Littauer Ear Polypus Forceps	350	
Littauer Forceps	110	
Littauer Polypus Forceps	327	
Littauer Scissors	73	
Littler Scissors	60	
Liver-Gall-Kidney Instruments	427-432	
Lobe Grasping Forceps	469	
Lockhart-Mummery Probes	28	
Locklin Scissors	63, 89	
Lockwood Grasping Forceps	187	
Logan Retractors	231	
Loops for Snare	353	
Lorenz Bandage Scissors	571	
Lorna Towel Forceps	191	
Loute Wire Tightener	550	
Love Nerve Root Retractors	297	
Love-Grünwald Rongeurs	486	
Lovelace Grasping Forceps	186	
Lovelance Forceps	384	
Lower Forceps	146	
Lowmann Bone Holding Clamps	535	
Lubet-Barbon Tampon Forceps	327	
Luc Septum Forceps	337	
Lucae Ear Hooks	349	
Lucae Forceps	108	
Lucae Hooks	223	
Lucae Mallets	495	
Lucae Myringotomes	352	
Lucae Tuning Forks	343, 344	
Luer Bone Rongeurs	536, 538, 540, 541	
Luer Retractors	216	
Luer Trachea Retractor	321	
Luer-Friedmann Bone Rongeurs	536	
Luer-Koerte Gall Stone Scoops	430	
Luer-Stille Bone Rongeur	540, 541	
Lukens Trachea Retractors	322	
Lung Instruments	366-385	
Lung Spatula	383	
Luniatschek Tonsil Packers	316	
Lupus Scraper	25	
M		
Magill Catheter Forceps	469	
Mallets	494-497	
Maltz Rasp	521, 522	
Markwalder Bone Rongeurs	541	
Marquardt Bone Rongeurs	539	
Marschik Tonsil Forceps	312	
Martel Grasping Forceps	189	
Martin Meniscus Forceps	545	
Martin Pelvimeter	461	
Martin Retractors	213	
Martin Uterine Probes	447	
Martin-Langenbeck Elevators	517	
Masing Needle Holders	277	
Massing Elevator	331	
Massing Nasal Chisels	334	
Massing Nasal Hooks	336	
Masson Needle Holders	258, 280	
Massing Seizin Forceps	322	
Mathieu Foreign Body Forceps	470	
Mathieu Needle Holders	259, 282, 287	
Mathieu Rectal Specula	423	
Mathieu Retractors	215	
Mayfield Bone Rongeurs	539	
Mayo Scissors	49, 50, 80, 84, 90	
Mayo-Blake Gall Stone Forceps	432	
Mayo-Harrington Scissors	49, 80	
Mayo-Hegar Needle Holders	255, 274	
Mayo-Lexer Scissors	84	

Hemorrhoidal Ligator	.425	Joseph Scissors	.58, 87
Henke Dissectors	.313	Joseph Septum Knives	.328, 329
Henley Retractor	.234	Judd-Allis Grasping Forceps	.189
Henning Plaster Spreader	.575	Jurasz Laryngeal Forceps	.319
Herrick Forceps	.148	K	
Heymann Polypus Forceps	.327	Kabierske Powder Blower	.346
Heymann Scissors	.57	Kahler Laryngology Tip	.320
Heymann Septum Forceps	.337	Kallmorgen Vaginal Specula	.439
Hibbs Chisel	.503	Kane Umbilical Cord Clamp	.463
Hibbs Gouges	.504	Katsch Comedone Extractor	.26
High Precision Instrument	.489	Kelly Anoscopes	.423
Hoer Dissectors	.297	Kelly Forceps	.130, 141
Hoer Raspatories	.514	Kelly Grasping Forceps	.183
Hohmann Bone Levers	.518, 519	Kelly Retractors	.208
Hoke Chisel	.503	Kelly Scissors	.58, 87
Holding Forceps	.312	Kelly-Rankin Forceps	.129
Holzheimer Retractors	.231	Kern-Lane Bone Holding Fcps.	.532
Hooks, fine	.223-229	Kerrison Punches	.478-481
Hopkins Plaster Knives	.576	Kervorkian Aspirating Curette	.453
Horsley Nerve Root Retractor	.298	Kervorkian Biopsy Forceps	.458
Hösel Needle Holders	.283	Key Bone Cutting Forceps	.544
Hösel Retractors	.209	Keyes Dermal Punch	.25
House Bone Curettes	.363	Kidney Bowls	.587
House Micro Needles	.361	Kidney Pedicle Forceps	.147, 148
House-Dieter Ear Forceps	.357	Kidney Stone Forceps	.431
Huber Universal Handle	.320	Killian Elevators	.330
Hudson Burrs	.555	Killian Gouges	.332
Hudson Hand Drill	.555	Killian Nasal Specula	.325
Hunt Forceps	.114, 116	Killian Raspatories	.510
Hunter Forceps	.111	Killian Septum Scissors	.339
Hurd Dissectors	.313	Kilner Hooks	.229
Hurd Ligature Needles	.316	Kilner Nasal Retractors	.335
Hypodermic Syringes	.34	Kilner Needle Holders	.278
Hysterectomy Forceps	.143	Kilner Scissors	.55, 85
Hysterectomy Scissors	.81	Kilner-Doughty Mouth Gag	.309
I		Kirschner Guiding Probes	.266, 267
Inge Lamina Spreader	.304	Kirschner Retractors	.249
Interchangeable Blades	.506	Kirschner Wire	.559, 560
Intestinal Clamps	.409-420	Kirschner Wire Traction Bow	.549
Intestinal-/Stomach Suture Set	.421	Kirschner wires dispenser	.559
Iowa Tenaculum Forceps	.450	Klapp Hooks	.225
Iris Scissors	.61, 88	Kleinert-Kutz Tendon Forceps	.548
Israel Retractors	.197	Klinkenbergh-Loth Scissors	.62
Iterson Trachea Retractors	.321	Knowles Bandage Scissors	.571
Ives-Fansler Anoscope	.423	Kocher Forceps	.132
J		Kocher Intestinal Clamps	.409, 410, 412, 413
Jackson Trachea Retractor	.321	Kocher Retractors	.195, 200, 201, 205, 207, 228
Jacobs Tenaculum Forceps	.451	Kocher Trachea Directors	.322
Jacobson Probes	.399	Koerte Abdominal Spatulas	.219
Jacobson Suture Pusher	.400	Koerte Retractors	.197
Jacobson Vessel Knives	.405	Kogan Endospecula	.443
Jameson Needle Holders	.258	Köln Scalp Clips	.292
Janef Hypodermic Syringes	.34	König Elevators	.516
Jansen Bone Curettes	.348	König Guiding Probes	.267
Jansen Bone Rongeurs	.537, 539	König Hooks	.227
Jansen Forceps	.108	König Raspatory	.509
Jansen Retractors	.231	Koos Vessel Knives	.405
Jansen Septum Forceps	.339	Kraus Vessel Knives	.405
Javid Forceps	.172	Krause Laryngology Tips	.320
Jennings Mouth Gag	.308	Krause Polypus Snares	.328
Jeweller Type Forceps	.111	Krause Trocar	.32
Jobson-Horne Cotton Applicator	.28	Krause-Voss Polypus Snares	.328
Johns-Hopkins Forceps	.146, 151	Krayenbühl Vessel Hook	.400
Jones Towel Forceps	.191	Kressner Septum Forceps	.338
Joseph Elevators	.331	Kristeller Vaginal Specula	.437-439
Joseph Hooks	.229	Kronecker Ligature Needles	.263
Joseph Nasal Saws	.334	Krönlein Forceps	.131
Joseph Raspatory	.510	Kümmel Abdominal Spatulas	.218
Joseph Rasps	.521	Kümmel Retractors	.206

Olivecrona-Toennis Forceps	.293	Prostatic Retractors	.222
Ollier Retractors	.197	Providence-Hospital Forceps	.130
Olson-Hegar Needle Holders	.259, 281	Pudendus Needle	.33
Operating Scissors	.41-63, 78-87	Punches	.477-482
Organ Holding Forceps	.183-189	Putti Rasps	.523
Oscillating Plaster Saws	.577		
Osteotomes	.498-508	Q	
O'Sullivan-O'Connor Specula	.443	Quervain Elevator	.516
Otoscopy Set	.347	Quire Foreign Body Instrument	.350
Overholt Forceps	.136, 139, 140		
Overholt-Geissendörfer Forceps	.136	R	
Ovum Curettes	.465	Rabiner Percussion Hammer	.3
Ovum Forceps	.464, 465	Radolf Nail Extracting Forceps	.582
		Ragnell Scissors	.55
P		Ragnell-Davis Hooks	.229
Parametrium Scissors	.49, 80	Ralk Splinter Forceps	.583
Parker Retractors	.215	Rampley Holding Forceps	.185
Parks Rectal Spreader	.424	Randall Aspirating Curettes	.453
Partsch Chisel	.499	Randall Kidney Stone Forceps	.431
Partsch Gouges	.499	Raney Forceps	.292
Partsch Mallets	.496	Rankin Forceps	.129, 134
Passow Tamper	.498	Raspatories	.359, 360, 510-515
Patella Forceps	.530	Rasps	.521-524
Paul Retractors	.230	Razor	.24
Payr Guiding Probes	.268	Recamier Uterine Curettes	.460
Payr Intestinal and Stomach Clamps	.417	Rectal Biopsy Forceps	.426
Péan Forceps	.125, 126, 158	Rectal Speculas	.422, 423
Pederson Vaginal Specula	.436	Rectal Spreader	.424
Peef Splinter Forceps	.583	Rectum Instruments	.407-426
Pelvimeters	.461	Redon Guide Needles	.30
Penfield Dissectors	.393	Reicher Epiglottis Retractor	.319
Pennington Elevator	.330	Reill Bone Holding Forceps	.529
Pennington Grasping Forceps	.186	Reill Needle Holders	.261
Percussion Hammers	.3	Reill Scissors	.70
Percy Amputation Retractor	.490	Reiner Plaster Knives	.576
Periosteal Knives	.352	Replacement Edges	.554
Peritoneum and Vaginal Forceps	.142-144	Resano Cartilage Scissors	.50
Perthes Riemers	.493	Resano Rectal Clamps	.419
Pestalozza Ovum Forceps	.465	Retractors	.193-251, 300-304
Petz Suture Set	.421	Reverdin Abdominal Spatulas	.217
Phalangeal Knife	.18	Reverdin Needles	.262
Phaneuf Forceps	.142	Rib Contractors	.382
Pierce Elevator	.330	Rib Instruments	.367-382
Pierce Trocar	.32	Rib Shears	.367-370
Pinard Stethoscopes	.4	Rib Spreaders	.371-382
Pinwheel	.5	Ricard Retractors	.244
Plaster Breakers	.576	Richardson Retractors	.212
Plaster Instruments	.569-577	Richter Scissors	.44
Plaster Knives	.576	Richter-Heath Suture Forceps	.269
Plaster Saws	.576, 577	Riemers	.493
Plaster Scissors	.573-575	Ring Strippers	.390
Plaster Spreader	.575	Ritter Frontal Sinus Bougies	.28
Plester Hooks	.360	Robb Dissectors	.395
Plester Retractors	.233	Roberts Forceps	.140
Plester Scaper	.361	Rochard Retractors	.251
Plester Suction Tubes	.35	Rochester Forceps	.125, 128
Politzer Air Bag	.345	Roeder Tonsil Snare	.314
Politzer Myringotomes	.352	Roeder Towel Forceps	.190
Polloson Retractors	.211	Roger Elevator	.330
Polypus Forceps	.327	Rogers Forceps	.143
Poole Suction Tubes	.36	Roller Knives	.359
Post Mortem Knives	.20	Rongeurs	.486-488
Potts-Smith Forceps	.97, 102, 119	Rose Retractors	.216
Potts-Smith Scissors	.63, 64, 89	Rose Trachea Retractor	.321
Powder Blower	.346	Rosen Curettes	.360
Pozzi Tenaculum Forceps	.448, 449	Rosen Flap Knives	.359
Pratt Forceps	.144	Rosen Hooks	.360
Pratt Tenaculum Forceps	.451	Rosen Lancet Knives	.359
Price-Thomas Bronchus Forceps	.385	Rosen Raspatories	.360
Price-Thomas Forceps	.149	Rosenburg Laryngology Tip	.320
Probes	.27-28, 399	Roser-König Mouth Gag	.308

Ross Retractors	.230	Screw Driver	.564
Roux Retractors	.214	Scudder Intestinal Clamps	.415
Rubbel Bulb	.345, 346	Sebileau Elevator	.516
Rubin Osteotomes	.333	Sedillot Raspatory	.512
Rubin Septum Forceps	.339	Segond Myotome	.21
Rudd Hemorrhoidal Ligator	.425	Segond-Landau Forceps	.142
Rulers	.6	Sellheim Obstetrics Lever	.463
Rumel Forceps	.139	Sellors Rib Contractor	.382
Rumel-Belmont Tournique	.396	Selman Forceps	.98
Ruskin Bone Cutting Forceps	.543	Semb Bone Cutting Forceps	.544
Ruskin Bone Rongeurs	.539, 540	Semb Bone Holding Forceps	.531
Russ. Model Forceps	.98	Semb Bone Rongeurs	.541
Russel-Davis Tongue Blades	.310	Semb Bronchus Forceps	.385
Rust Amputation Saws	.491	Semb Raspatories	.513
Rydel-Seiffer Tuning Forks	.344	Semken Forceps	.96, 101, 119, 120
Ryder -Vascular Needle Holders	.286	Semm Vaginal Specula	.435
S			
Saalfeld Comedone Extractors	.26	Senn-Green Hooks	.228
Sachs Dissectors	.296	Senning Needle Holders	.276
Sachs Nerve Hook	.299	Senn-Miller Hooks	.228
Saenger Ovum Forceps	.465	Septum Forceps	.337, 338
Safety Pin for ring instruments	.192	Septum Instruments	.328-340
Salenius Meniscus Knives	.545	Septum Knives	.328
Salpingograph	.455	Septum Scissors	.339
Sami Forceps	.115, 116	Sequestrum Forceps	.530
Samii Tumor Knives	.404	Setting Forceps	.151
Santulli Clamps	.153	Sewall Elevators	.331
Sanvenero Scissors	.58	Sexton Myringotomes	.352
Sarof Forceps	.138	Seyffert Vaginal Specula	.436
Sarof Needle Holders	.256, 276	Shaaf Forceps	.110
Satinsky Clamps	.153, 173	Shambough Micro Needles	.361
Satinsky Scissors	.62	Shapleigh Ear Loops	.348
Satterlee Amputation Saw	.492	Sharp Hooks	.400
Sauerbruch Bone Rongeurs	.541	Shea Bone Curettes	.363
Sauerbruch Retractors	.203	Sickle Knives	.328, 359
Sauerbruch Rib Shears	.368, 369	Silver Dermatome	.24
Sauerbruch-Frey Rib Shears	.369	Simon Bone Curettes	.527
Scalp Clips	.292	Simon Hooks	.227
Scalp-Contour Retractors	.232	Simon Retractors	.213
Scalpel Blades	.13	Simpson Obstetrical Forceps	.462
Scalpel Handles	.10, 11	Sims Rectal Speculas	.422
Scalpels	.14-23	Sims Scissors	.45-46, 79
Schädel Towel Forceps	.191	Sims Uterine Curettes	.460
Schamberg Comedone Extractor	.26	Sims Uterine Depressor	.447
Scheinmann Larygology Tips	.320	Sims Uterine Probes	.447
Scherback Specula	.442	Sims Vaginal Specula	.437
Schink Dermatome	.24	Sims-Siebold Scissors	.46
Schmeden Nasal Forceps	.484	Sinuscopy Trocar	.31
Schmid Needles	.33	Skene Tenaculum Forceps	.449
Schmid Vascular Spatula	.394	Skin Trephines	.25
Schmieden Guiding Probes	.267	Skull Punch	.295
Schmieden-Dick Needles	.263	Skull Traction Tong	.294
Schmieden-Taylor Scissors	.63	Sluder-Balenger Tonsilotome	.316
Schmidt Forceps	.128	Smillie Meniscus Knives	.546
Schoemaker-Loth Scissors	.74	Smillie Meniscus Retractors	.546
Schoenborn Trachea Retractor	.322	Smith Bandage Scissors	.571
Schröder Fistula Knives	.21	Smith Scissors	.90
Schröder Tenaculum Forceps	.448, 449	Smith-Petersen Chisel	.505
Schröder Uterine Scoops	.459	Smith-Petersen Gouges	.505
Schubert Biopsy Forceps	.456	Smithwick Applying Forceps	.293
Schuhmacher Biopsy Forceps	.457, 458	Smithwick Nerve Hooks	.299
Schuhmacher Laryngology Tip	.320	Sommer Uterine Forceps	.452
Schulze Salpingograph	.455	Spare Blades	.317
Schumacher Umbilical Scissors	.48	Spare Snares	.315
Scissors	.39-75	Special Needles	.33
Scissors, wound edges	.43	Spencer Scissors	.73
Scoville Bone Curettes	.528	Spencer-Wells Forceps	.126
Scoville Nerve Root Retractors	.298	Spine Retractors	.300-304
Scoville Retractors	.300	Splinter Forceps	.110-111, 583
Scraper	.361	Sponge Forceps	.181-184
		Spongiosa Gouges	.508-509
		Spratt Bone Curettes	.526

Spurling Rongeurs	486	Tobald Tongue Depressor	307
Stacke Probe	27	Toennis Dissectors	395
Standard Trocars	31	Toennis Dura Knives	23, 298
Stellbrink Bone Rongeurs	536	Toennis Forceps	127, 133
Sterilization products	591 – 594	Toennis Needle Holders	284
Sterilizing Forceps	584	Toennis Nerve Hook	299
Sternberg Lip Retractor	311	Toennis Scissors	55
Sternum Chisel	368	Toennis-Adson Scissors	55, 85
Stethoscopes	4	Tohoku Towel Forceps	191
Stevens Scissors	60	Tongue Depressors	307-311
Stieglitz Splinter Forceps	583	Tongue Holding Forceps	311
Stille Bone Cutting Forceps	543	Tonsil Forceps	484
Stille Bone Rongeurs	540	Tonsil Holding Forceps	312
Stille Chisel	501	Tonsil Instruments	312-317
Stille Forceps	94, 100, 148	Tonsil Knives	22, 314
Stille Gouges	502	Tonsil Needles	33
Stille Osteotomes	501	Tonsil Retractors	316
Stille Plaster Scissors	575	Tonsil Scissors	56-57, 86
Stille-Barraya Forceps	104	Tonsil Snares	314, 315
Stockmann Penis Seizing Forceps	470	Tonsil Suture Needles	316
Stomach Intestinal Instruments	407-426	Tonsilotome	315
Stone Forceps	105	Tourniquets	396
Strabismus Scissors	54, 60	Towel Forceps	190, 191
Strabismus Scissors	60	Toynebee Ear Specula	347
Strandell-Stille Hooks	229	Trachea Instruments	321-322
Stratte Needle Holders	279	Trachea Retractors	225, 226
Strauss Penis Seizing Forceps	470	Traction Hooks	549
Struck Rib Spreaders	377	Trélat Vaginal Specula	436
Struempel Ear Polypus Forceps	351	Trigeminal Knives	22
Strully Scissors	62	Trocars	31
Struycken Rongeurs	488	Troemner Percussion Hammer	3
Subramanian Forceps	155	Trötsch Forceps	108
Suction Tubes	35-37	Trousseau Trachea Dilator	321
Suture Hook	396	Trouman-Christ Blade Holder	12
Suture Instruments	252-288	Tubbs Dilator	392
Suture Sets	269	Tubing Clamps	192
Suture Tying Forceps	112, 113	Tübingen Retractors	213
Sweden Pattern Forceps	93	Tübinger Modell Retractors	234
Sweet Applying Forceps	293	Tuffier Grasping Forceps	189
Swivel Knives	332	Tuffier Rib Spreaders	375
Synovectomy Rongeurs	536	Tumor Knives	404
Sypert Punches	481	Tuning Forks	343, 344
T		Turnbull Nail Cutter	582
Tabb Mukosa Knife	359	Tuttle Forceps	98
Takahashi Nasal Forceps	485	Twisting Forceps	551-554
Tamper	498	Tyding Tonsil Snare	315
Tampon and Polypus Forceps	327	U	
Taylor Forceps	96, 101, 102, 119	Ulrich Bone Holding Forceps	532
Taylor Meniscus Retractor	547	Ulrich Dressing Forceps	181
Taylor Percussion Hammers	3	Ulrich Fistula Knife	21
Taylor-Brown Forceps	104	Umbilical cord Scissors	48
TC Needle Holder	270-288	Universal Bandage Scissors	574
TC-Forceps	118-121	Universal Cotton Applicators	28
TC-Scissors	75-90	Universal Scissors	74, 90
TC-Twisting Forceps	551, 553	Universal Sterilizing Forceps	584
TC-Wire Cutter	553	Universal Trocar	31
TC-Wire Cutting Forceps	553	Unna Comedone Extractors	26
Teale Tenaculum Forceps	450	Unna-Vidal Comedone Extractor	26
Tenaculum Forceps	448-451	Urethral Bougies	471
Tendom Interlacing Forceps	547	Uterine Curettes	460
Tendon Seizing Forceps	547, 548	Uterine Depressors	447
Terrier Forceps	135	Uterine Dilators	444-446
Thoms-Gaylor Biopsy Forceps	457	Uterine Elevating Forceps	452
Thorax Instruments	366-385	Uterine Probes	447
Thorek Scissors	54, 85	Uterine Scoops	459
Tieck-Halle Nasal Specula	324	V	
Tissue Forceps	99-105	Vaccination Lancet	6
Tissue Grasping Forceps	183-189	Vaginal Forceps	142-144
Tissue Picks	400	Vaginal Specula	435-442
Titanium Bulldog Clamps	152		

TRS INSTRUMENTS

Vaginal Spreader	443	Wire Saws	492
Van Buren Bone Holding Fcps.	531	Wire Tightener	549, 550
Van Doren Biopsy Forceps	457	Wire Traction Bows	549
Vannas Scissors	66, 72	Wires	559
Varicose Vein Probe Set	389	Wisconsin-Foregger Laryngoscopes	8, 9
Vascular Dilators	391, 392, 399	Wolff Lupus Scraper	25
Vascular Instruments	387-405	Wolff Plaster Breakers	576
Vascular Needle Holders	285-287	Wound Clips	269
Vascular Scissors	62-65	Wound Suture Instruments	269
Vascular Spatulas	394	Wrench	549
Veidenheimer Anastomosis Clamps	420	Wullstein Ear Polypus Forceps	351
Vein Needle	33	Wullstein Retractors	233
Verbrugge Bone Holding Fcps.	533	Wullstein Suction Tubes	35
Vernet Hooks	228	Y	
Verres Needles	33	Yankauer Suction Tubes	36
Vessel Spreader	399	Yasargil Forceps	114-116
Vickers Bone Rongeurs	536	Yasargil Galea Hooks	292
Vidal Lupus Scraper	25	Yasargil Micro Raspatory	403
Virchow Brain Knife	20	Yasargil Micro Scoop	403
Virchow Scalpel	19, 20	Yasargil Needle Holders	261
Vise Forceps	112	Yasargil Rongeurs	488
Volkman Bone Curettes	526, 528	Yasargil Scissors	72
Volkman Retractors	195, 196	Yasargil Suction Tubes	36
Vollmar Needles	33	Yasargil Suture Pusher	400
Vollmar Ring Strippers	390	Yeoman Biopsy Forceps	426
Voltolini Nasal Specula	324	Young Prostatic Retractors	222
Von Eicken Suture Needle	316	Young Tongue Holding Forceps	311
W		Young-Millin Suture Instruments	268
Wachenfeldt Suture Forceps	269	Z	
Wagner Ear Hooks	350	Zaufal Bone Rongeurs	539
Wagner Hooks	223	Zaufal Ear Elevator	349
Wagner Scissors	59, 60, 87	Zenker Forceps	137
Waldmann Scissors	47, 80	Zenker Retractors	201
Walsham Septum Forceps	338	Ziegler Dura Knife	23
Walter Osteotomes	333	Zweifel Needle Holders	284
Walter Retractor	335		
Wangensteen Forceps	98, 120		
Wangensteen Needle Holder	258, 280		
Wartenberg Pinwheel	5		
Watson-Williams Nasal Forceps	485		
Waugh Forceps	99		
Weber Forceps	161		
Webster Needle Holders	257, 277		
Wecker Scissors	66		
Weder Tongue Depressors	307		
Weil Nasal Forceps	485		
Weil-Blakesley Nasal Forceps	483		
Weissbarth Vaginal Specula	442		
Weitlaner Retractors	232-235		
Wertheim Forceps	142-144		
Wertheim Scissors	46, 49		
Westcott Scissors	71		
White Tonsil Holding Forceps	312		
Whitehead Mouth Gag	308		
Wiener Model Specula	439		
Wiener Rasps	524		
Wilde Forceps	108		
Williger Bone Curettes	525, 526		
Williger Elevators	516		
Williger Mallets	495		
Williger Raspatories	509		
Winter Ovum Forceps	464		
Wire closure Forceps	356		
Wire Cutter	553, 554		
Wire Cutting Forceps	553, 554		
Wire cutting Scissors	74, 90		
Wire dispenser	559		
Wire Extension	549-555		
Wire for cerclage	550		
Wire for Snares	353		

Two pieces of thin, flexible metal or plastic, such as aluminum foil or plastic wrap

A pair of scissors

A ruler or other straight edge

A marker or pen

Measure and cut two pieces of metal or plastic to the desired length. The length of the blades will depend on the size of the nostrils you are trying to examine.

Fold each piece of metal or plastic in half lengthwise, creating a crease in the center.

Using the ruler or straight edge, bend each piece of metal or plastic into a C-shape.

The C-shape should be slightly smaller than the width of the nostrils you are trying to examine. Round off the edges of the C-shaped blades to prevent injury.

CONTACT US



05 -233-052-68



Info@trsstruments.com



+1(202)579-8202



+92-301-9643745



1, Bhinder, Tasleem Pura, Sialkot Pakistan