

TRS
INSTRUMENTS



CATALOG

DENTAL INSTRUMENTS



cGMP
FDA. (U.S.A)



GUARANTEE

**ALL TRS DENTAL INSTRUMENTS ARE GRANTEED
TO BE FREE FROM DEFECTS IN WORKMANSHIP AND
MATERIALLY AND INSTRUMENTS WHICH PROVES
DEFECTIVE WHEN USED FOR ITS INSTENDED SURGICAL
PURPOSE WILL BE REPLACED OR REPAIR AT NO COST.**

**ALL INSTRUMENTS
SHOWN IN THIS CATALOG
ARE MADE OF STAINLESS
STEEL, UNLESS
OTHERWISE MENTIONED**

Section Index



Serial No.	Description	Page No.	Serial No.	Description	Page No.
1	Extracting Forceps (DNF #)	5-19	20	Gauges & Dividers	59
2	Elevators (DNL #)	20-23	21	Hand Instruments (Explorers, Probes Excavators, Curettes, Scalers, Periodontal, Plastic Filling Instruments)	60-75
3	Rongeurs	24-27	22	Amalgam Instruments	76-77
4	Bone Curettes, Files And Chisels	28-31	23	Crown Instruments	78
5	Bone Mallets, Forceps	32-33	24	Matrix Retainers & Bands	79
6	Lip & Cheek Retractors	34	25	Wax, Porcelain And Cement Instruments	80-85
7	Tongue Seizing Forceps, Depressors	35	26	Misc. Lab Instruments	86
8	Mouth Gags	36	27	Pliers	87-90
9	Gum Scissors	37-41	28	Orthodontic Items	91
10	Surgical Scissors	42-43	29	Endo Instruments	92-93
11	C&c Scissors	44	30	Articulating Paper Forceps	94
12	Tissue & Dressing Forceps	45-46	31	Rubber Dam Instruments	95
13	Tissue Retractors	47	32	Scalpels	96-97
14	Towel Claps, Napkin Holders	48	33	Probes & Suction Tubes	98
15	Hemostatic Forceps	49	34	Alphabetical Index	99-101
16	Needle Holders	50-54			
17	Impression Trays	55-56			
18	Cotton & Dressing Pliers	57			
19	Mouth Mirrors	58			

EXTRACTING FORCEPS



UPPER MOLARS

**“Sure-Grip”
Serrated
Beaks**

All extracting
forceps also available
with serrated beaks.



To obtain sure-grip
serrated beaks specify
“SB” after forceps
model number.

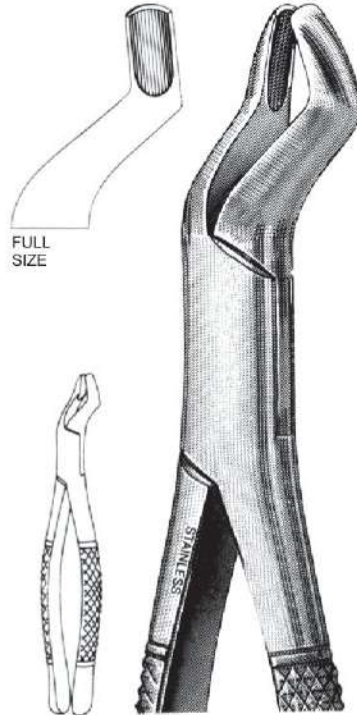

DNF 10S
Upper Molars;
Universal

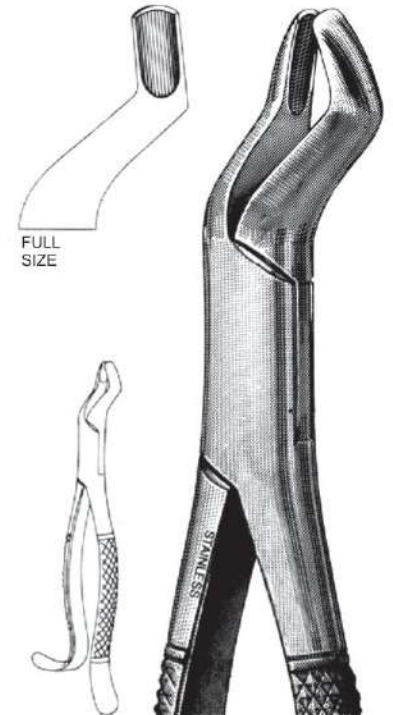

DNF 10H
Upper Molars, Hook
Handle; Universal

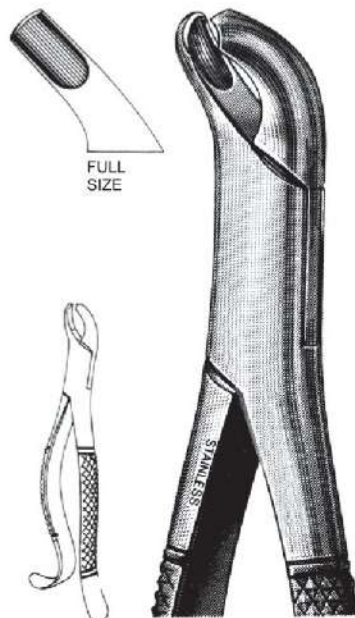

DNF 18L
1st & 2nd Upper
Molar; Left

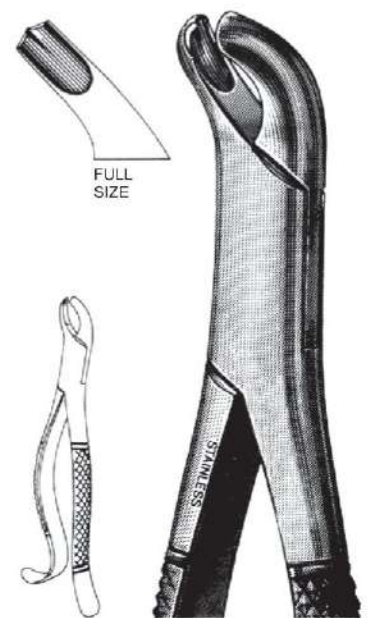

DNF 18R
1st & 2nd Upper
Molar; Right

To obtain sure-grip serrated beaks specify ‘SB’ after forceps model number.

EXTRACTING FORCEPS



UPPER MOLARS

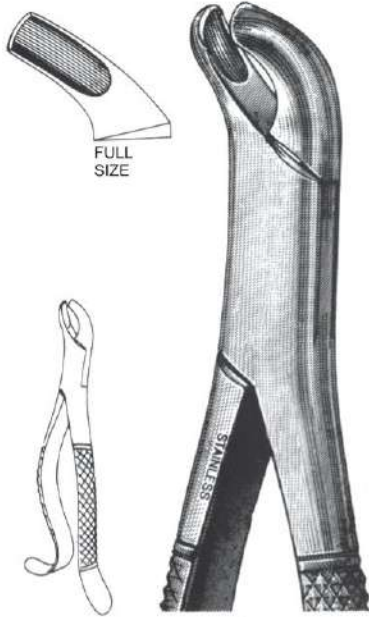

DNF 24
Upper Molars; Universal

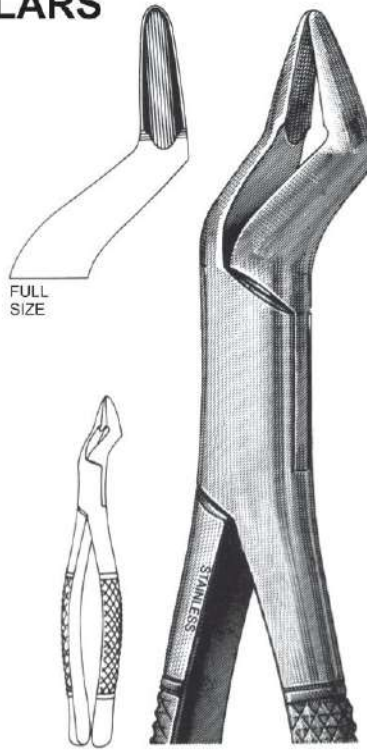

DNF 32
Upper Cuspids, Bicuspids
and Molars; Universal

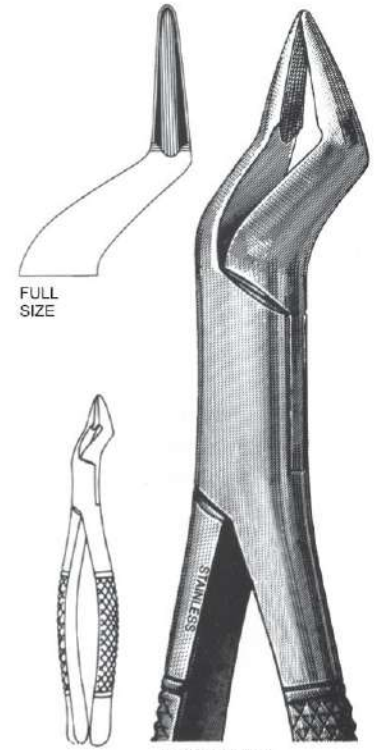

DNF 32A
Upper Cuspids, Bicuspids,
Molars and Roots; Universal

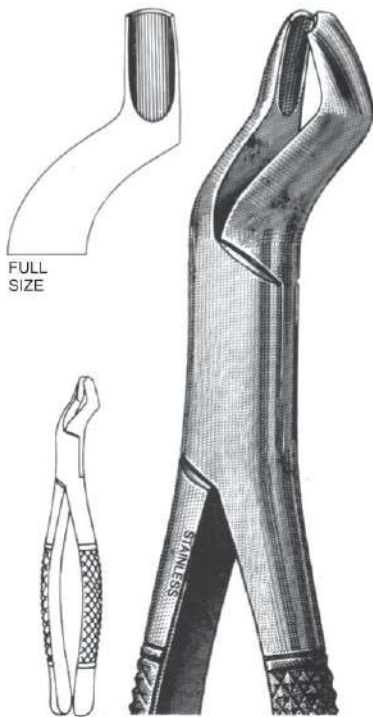

DNF 53L
1 st and 2nd Upper Molars; Left

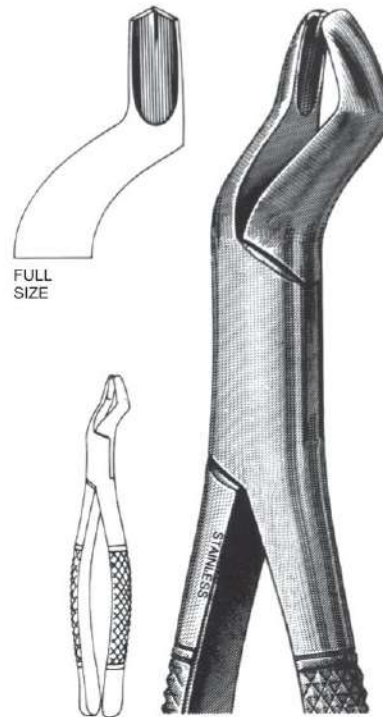

DNF 53R
1 st and 2nd Upper Molars; Right

To obtain sure-grip serrated beaks specify 'SB' after forceps model number.

EXTRACTING FORCEPS



UPPER MOLARS



FULL
SIZE



DNF 88L

1 st and 2nd Upper Molars; Left



FULL
SIZE

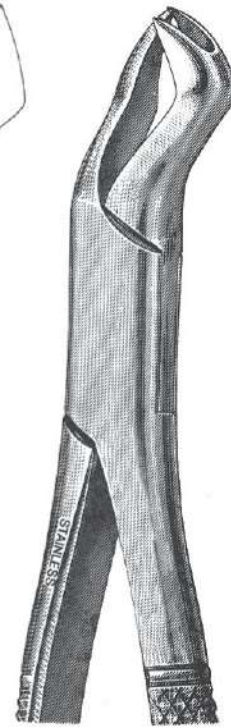

DNF 88R

1 st and 2nd Upper Molars; Right

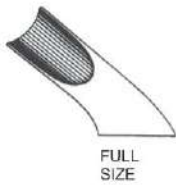

FULL
SIZE

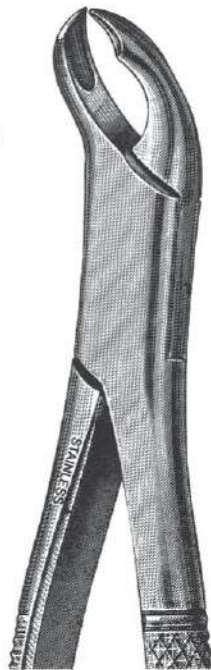

DNF 90

Upper Molars; Left

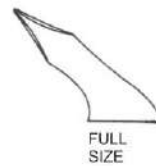

FULL
SIZE

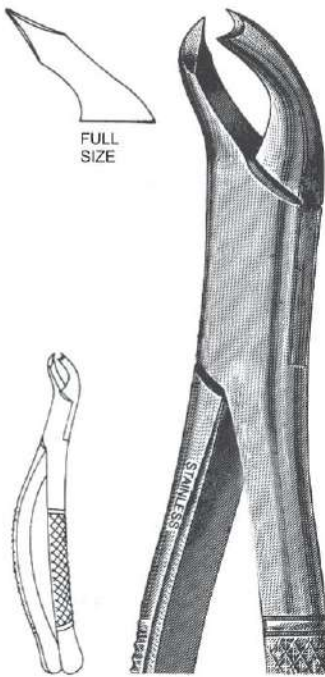

DNF 89

Upper Molars; Right

To obtain sure-grip serrated beaks specify 'SB' after forceps model number.

EXTRACTING FORCEPS



UPPER MOLARS

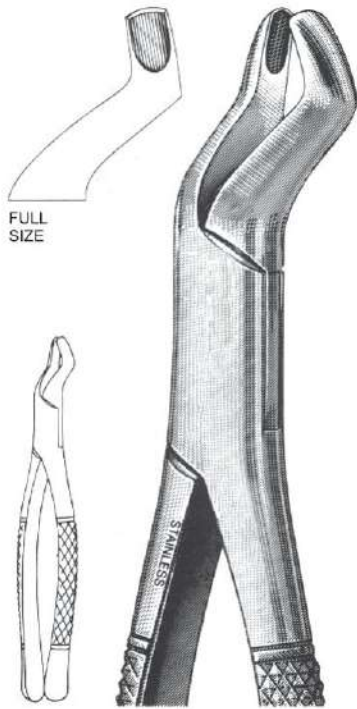

DNF 210S
3rd Upper Molars; Universal

LOWER MOLARS

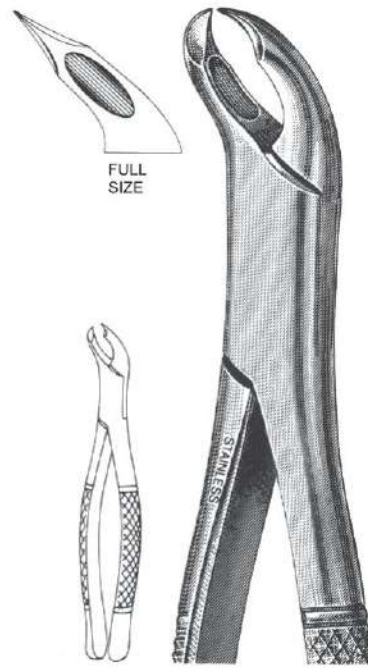

DNF 3FS
Lower Molars; Woodward

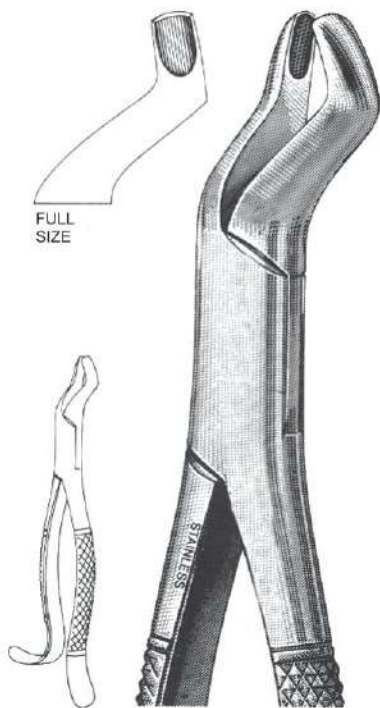

DNF 210H
3rd Upper Molars; Universal, Hook Handle

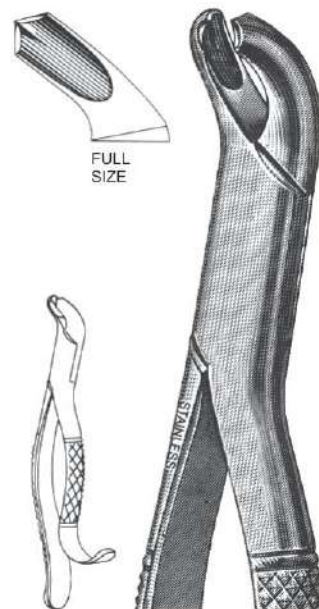

DNF 15
1st & 2nd Lower Molars; Universal

To obtain sure-grip serrated beaks specify 'SB' after forceps model number.

EXTRACTING FORCEPS



LOWER MOLARS

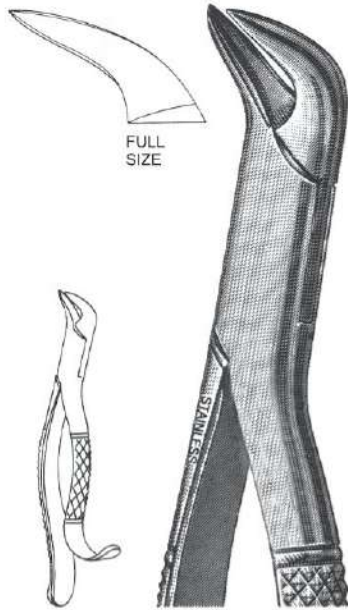

DNF 16

1 st & 2nd Lower Molars;
Universal; Cow Horn

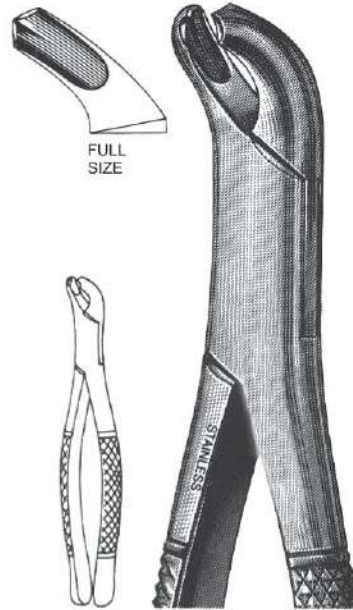

DNF 17

1 st & 2nd Lower Molars; Universal

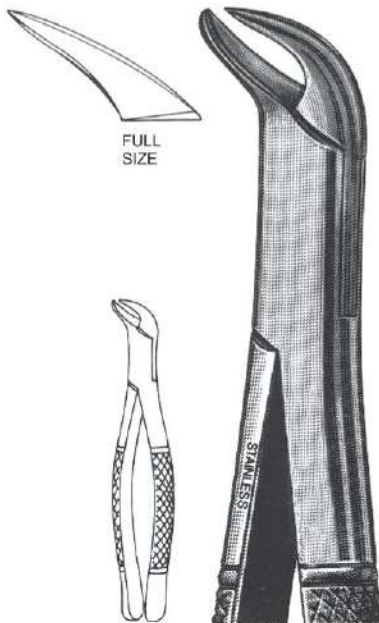

DNF 23

1 st & 2nd Lower Molars;
Universal; Cow Horn

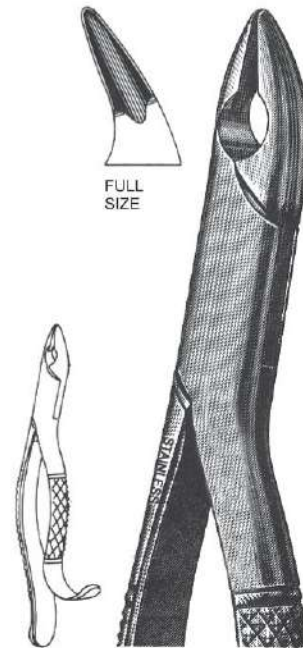

DNF-85A

Lower Molars, Cuspids
and Bicuspid; Universal

To obtain sure-grip serrated beaks specify 'SB' after forceps model number.

EXTRACTING FORCEPS



LOWER MOLARS

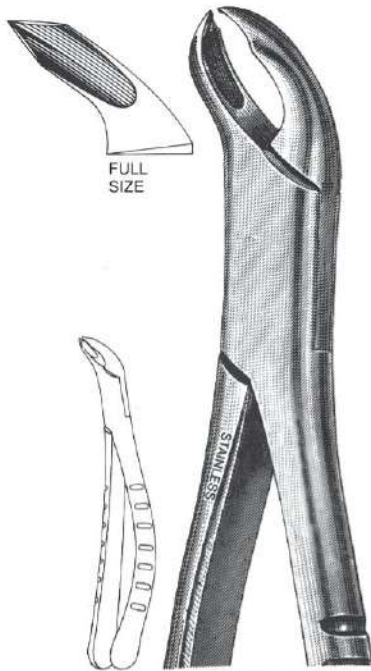

FULL
SIZE

DNF 217

1st & 2nd Lower Molars; Universal

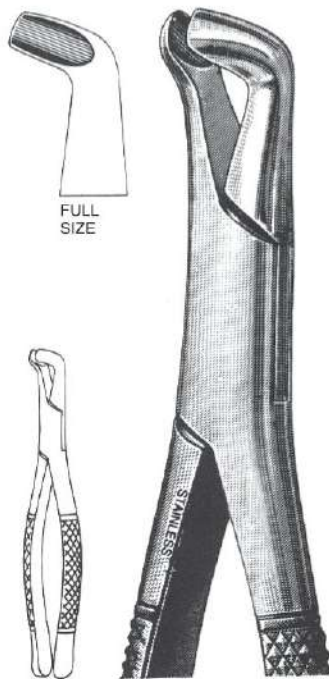

FULL
SIZE

DNF 222

3rd Lower Molar; Universal

UPPER MOLARS

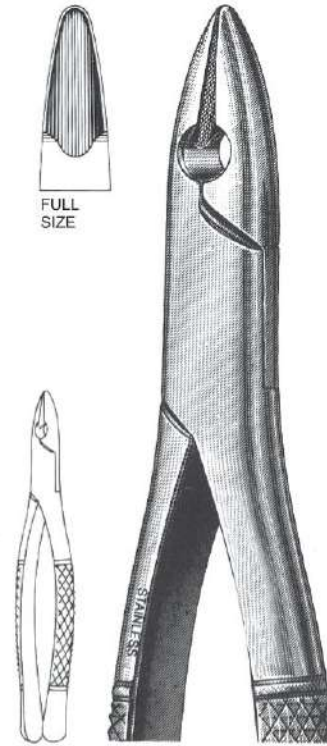

FULL
SIZE

DNF 1STD

Upper Incisors and cuspids

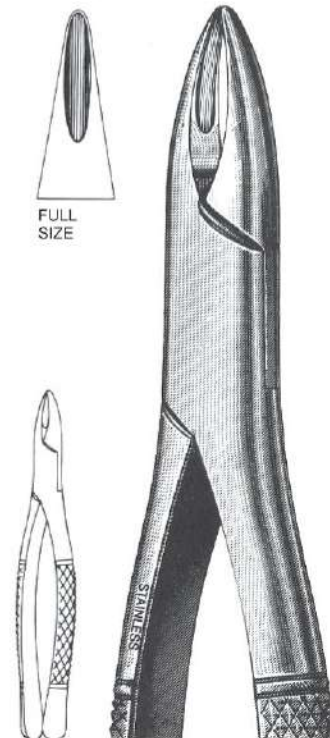

FULL
SIZE

DNF 1HEN

Upper Incisors; Henahan

To obtain sure-grip serrated beaks specify 'SB' after forceps model number.

EXTRACTING FORCEPS



UPPER ANTERIORS

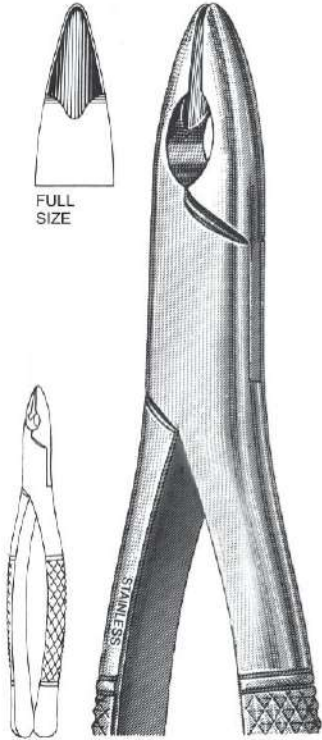

FULL
SIZE

DNF 99C

Upper Incisors, Cuspids
and Bicuspids

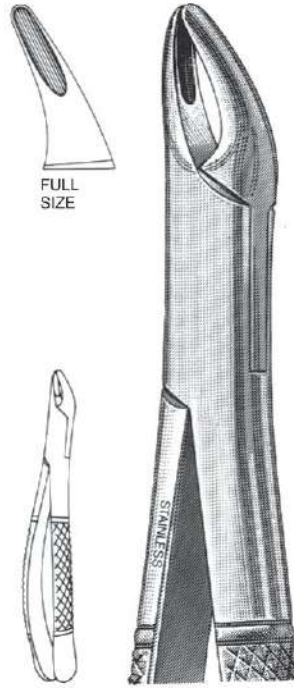

FULL
SIZE

DNF 150

Upper Incisors, Cuspids,
Bicuspids and Roots; Universal

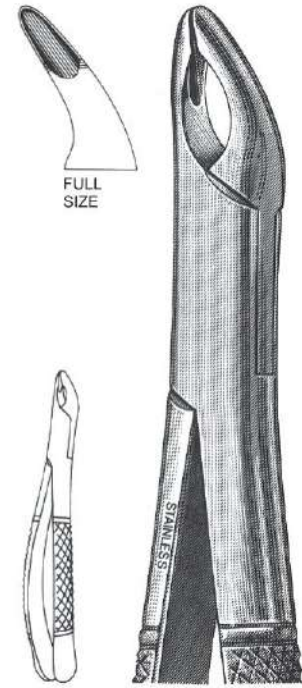

FULL
SIZE

DNF 150A

Upper Incisors, Cuspids,
and Bicuspids; Universal;
Parallel Beaks

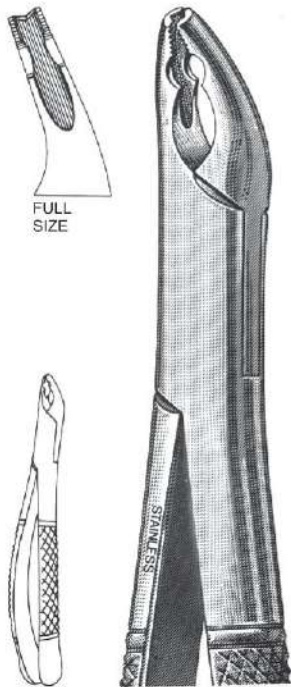

FULL
SIZE

DNF 150AS

Upper Anteriors; Split Beaks; Serrated

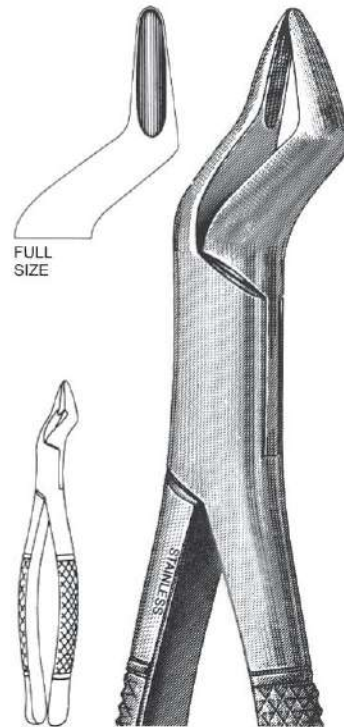

FULL
SIZE

DNF 286

Upper Bicuspids, Incisors and Roots

To obtain sure-grip serrated beaks specify 'SB' after forceps model number.

EXTRACTING FORCEPS



LOWER ANTERIORS

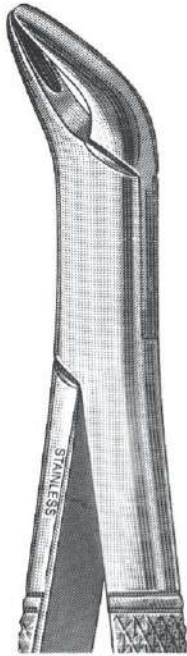
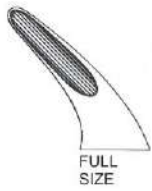

DNF 151
Lower Incisors, Cuspids,
Bicuspid and Roots, Universal

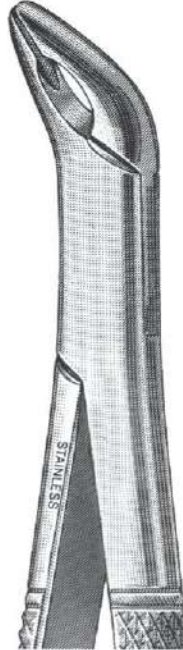

DNF 151A
Lower Incisors,
Cuspids, Bicuspid
universal; parallel beaks

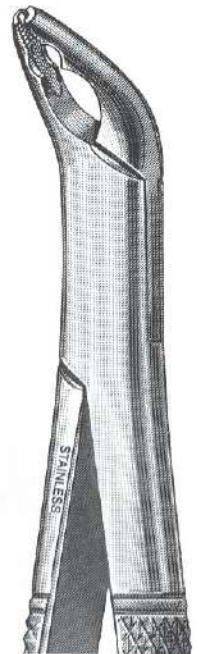
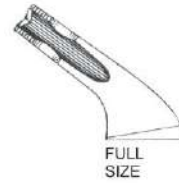

DNF 151AS
Lower Anteriors;
Split Beaks; Serrated

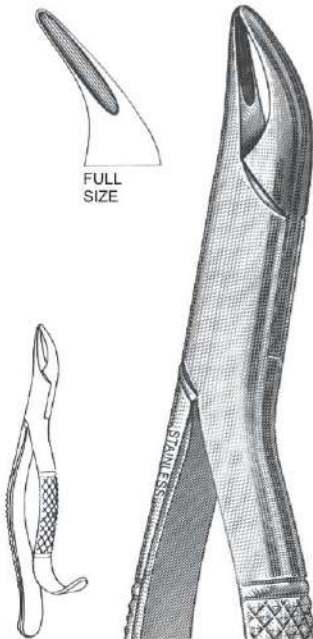

DNF 103
Lower Bicuspid,
Incisors and Roots; Universal

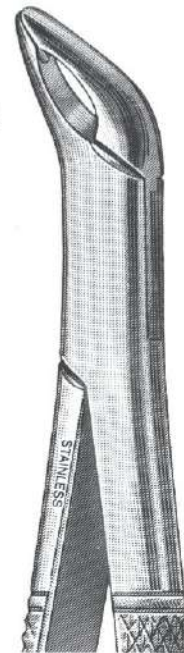
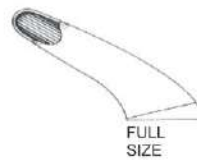

DNF 203
Lower Bicuspid, Cuspids,
Incisors and Roots, Universal

To obtain sure-grip serrated beaks specify 'SB' after forceps model number.

EXTRACTING FORCEPS



UPPER AND LOWER ANTERIORS AND SPLITTING

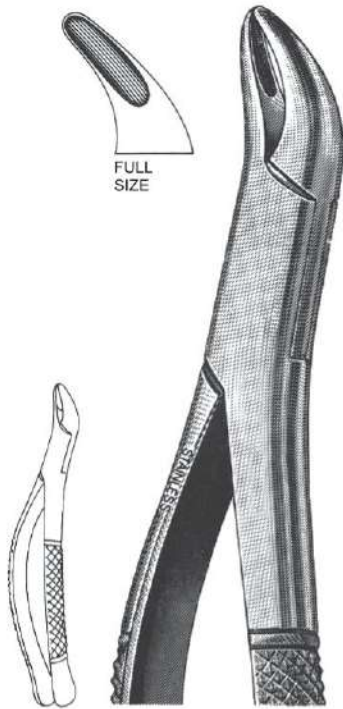

DNF 62

Upper and Lower incisors, Cuspids, Bicuspids and Deciduous; Universal

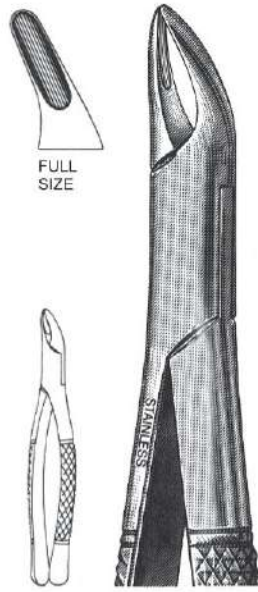

DNF 101

Upper and Lower Bicuspids and Deciduous; Universal

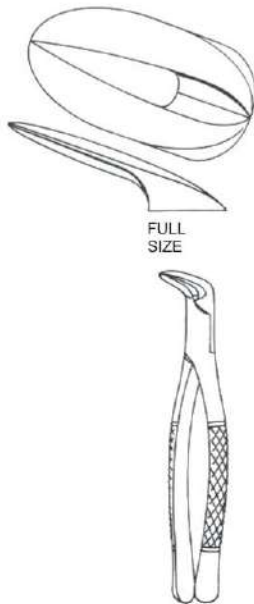

DNF 6

Upper and Lower Splitting and Separating

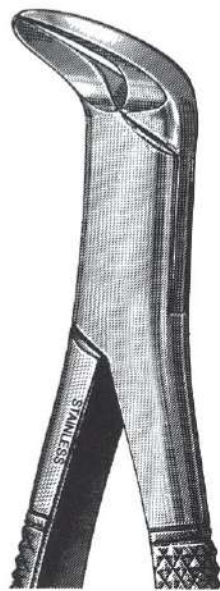

DNF 65

Upper Incisors, Roots and Fragments

ROOTS

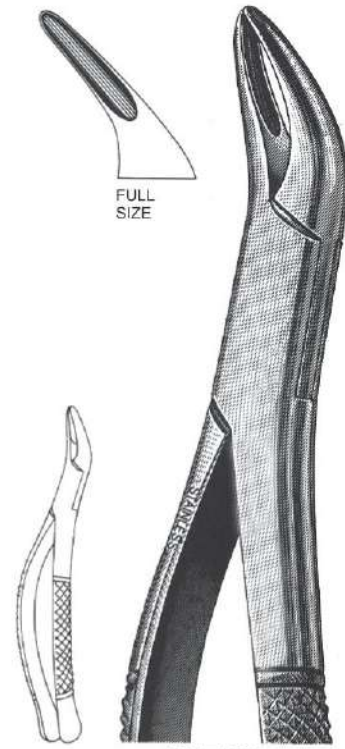

DNF 69

Upper and Lower Fragments and Roots

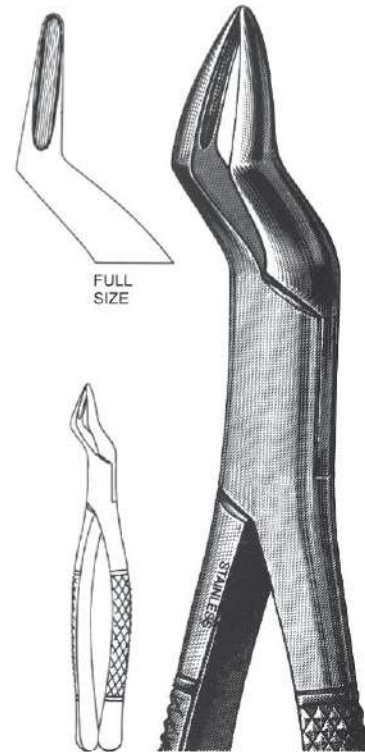

To obtain sure-grip serrated beaks specify 'SB' after forceps model number.

EXTRACTING FORCEPS



ROOTS

SPLINTER

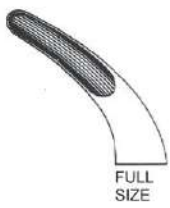

DNF 116
Witzel Lower
Roots;
Universal

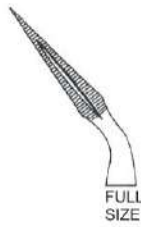

35-168
Stieglitz Fragment,
5 1/4", 45°



35-169
Stieglitz Fragment, 5 1/2" Straight



35-170
Stieglitz Fragment, 4 3/4", 90°

DNF 120
Witzel Upper Roots;
Universal

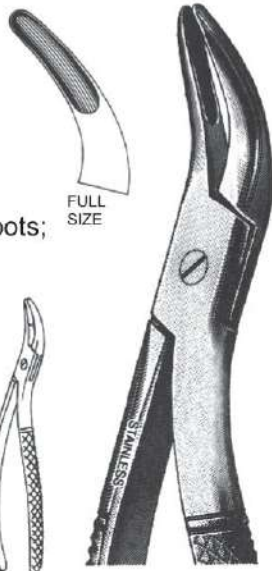

FULL
SIZE



35-171
Peets Splinter, 4 3/4", 45°

To obtain sure-grip serrated beaks specify 'SB' after forceps model number.

EXTRACTING FORCEPS



MEAD PATTERN



DNF MD1
Upper Incisors, Cuspids, Bicuspid and Roots: Mead; Universal.

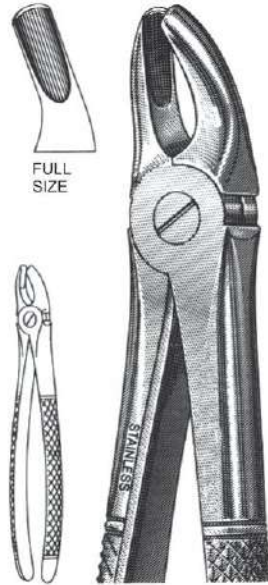

DNF MD2
Upper 1st, 2nd and 3rd Molars; Mead; Universal

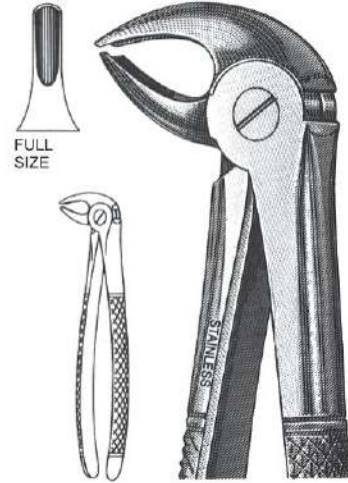

DNF MD3
Lower Incisors, Cuspids, Bicuspid and Roots; Mead; Universal

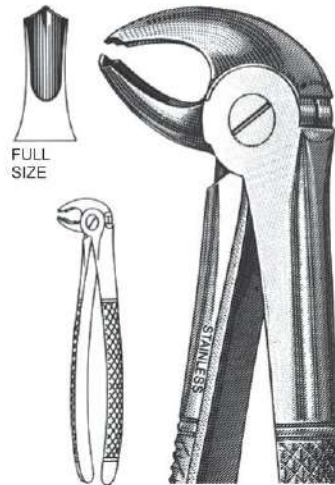

DNF MD4
Lower 1st, 2nd and 3rd Molars; Mead; Universal

To obtain sure-grip serrated beaks specify 'SB' after forceps model number.

EXTRACTING FORCEPS



ENGLISH PATTERN



FULL SIZE



DNF 13
Lower Bicuspid; Universal



FULL SIZE

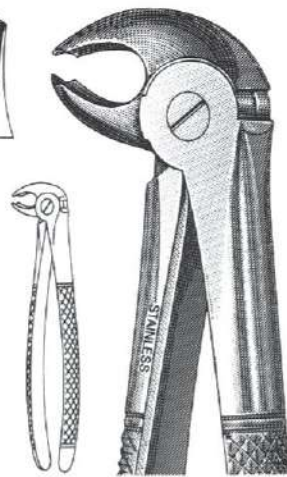

DNF 22
Lower Molars; Universal



FULL SIZE

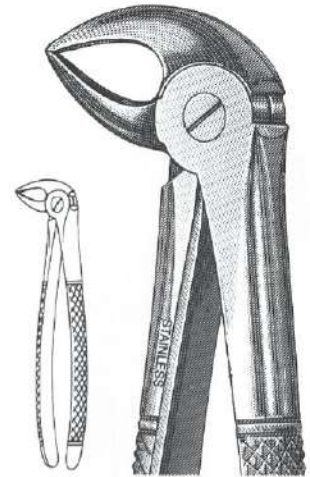

DNF 33
Lower Roots



FULL SIZE

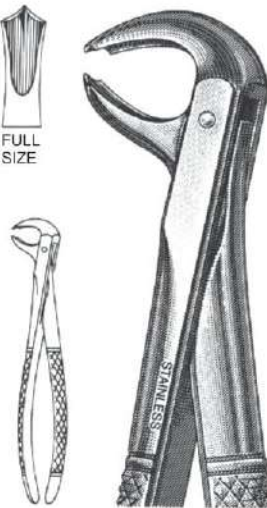

DNF 73
Lower Molars; Universal

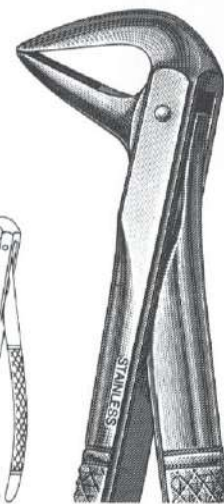

DNF 74
Lower Roots



FULL SIZE

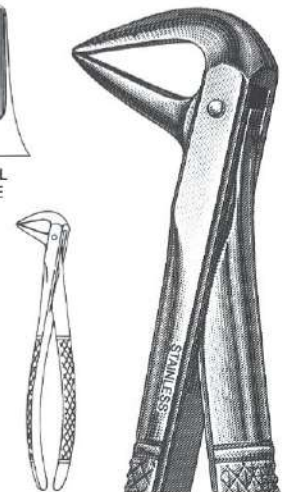

DNF 74N
Lower Roots; Narrow Beaks

To obtain sure-grip serrated beaks specify 'SB' after forceps model number.

EXTRACTING FORCEPS



PEDODONTIC

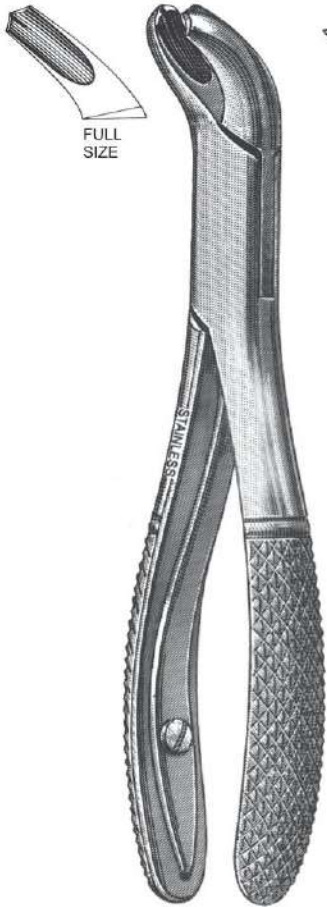

DNF 17S
Pedo Lower Molars;
Universal; Spring Handle;
4 3/4 "

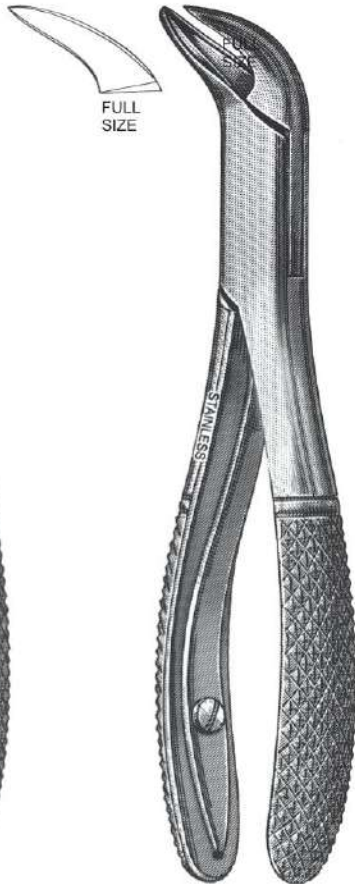

DNF 23S
Pedo Lower Molars
Universal; Cow Horn;
spring Handle; 4 3/4 "

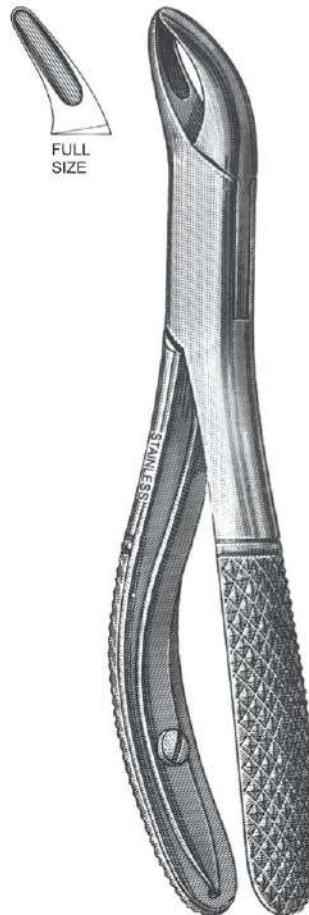

DNF 150 1/2S
Pedo Upper Incisors, Bicuspids
and Roots; Universal;
Spring Handle; 4 3/4 "

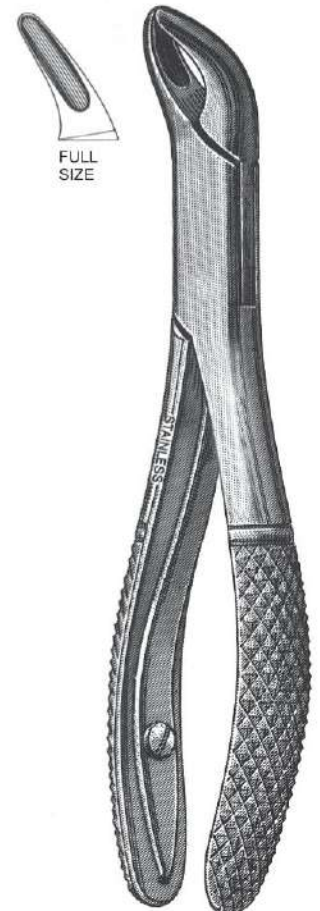

DNF 151 1/2S
Pedo Lower Incisors,
Bicuspids and Roots;
Universal; Spring Handle;
4 3/4 "

To obtain sure-grip serrated beaks specify 'SB' after forceps model number.

EXTRACTING FORCEPS



PEDODONTIC



DNF 16S
Pedo Lower Molars; Cow Horn

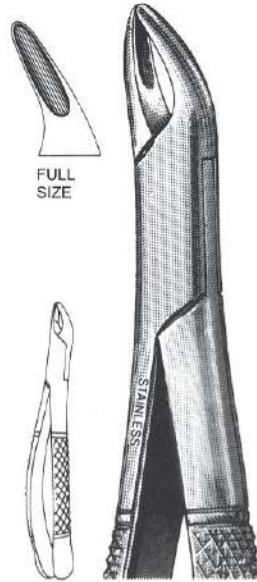

DNF 150S
Pedo Upper Incisors,
Bicuspids and Roots;
Universal

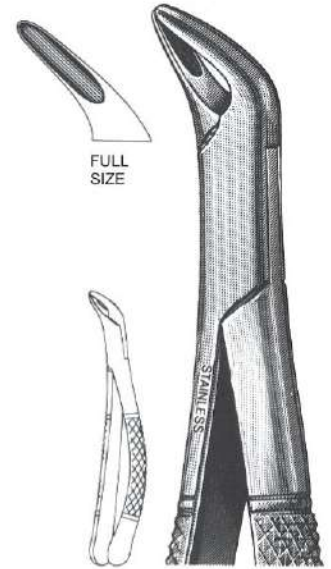

DNF 151S
Pedo Lower Incisors,
Bicuspids and Roots;
Universal

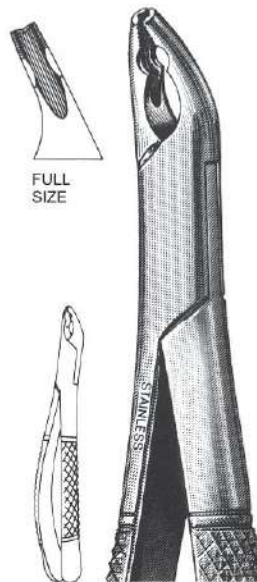

DNF 150XAS
Pedo Upper Anteriors;
Split Beaks, Serrated

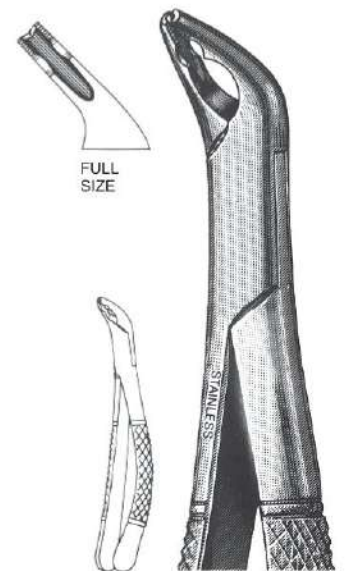

DNF 151XAS
Pedo Lower Anteriors;
Split Beaks, Serrated

To obtain sure-grip serrated beaks specify 'SB' after forceps model number.

EXTRACTING FORCEPS



PEDODONTIC-ENGLISH PATTERN

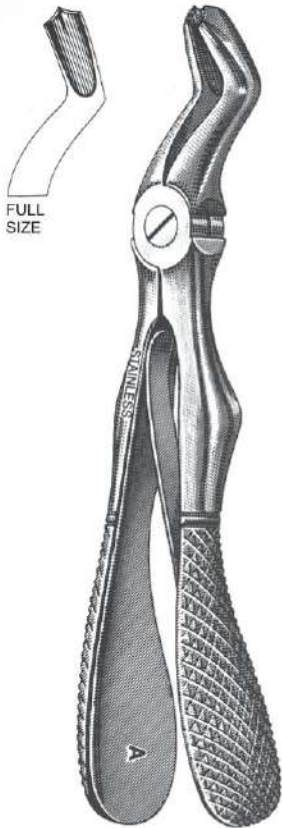

DNF A
Pedo Upper Molar;
Universal; Mini

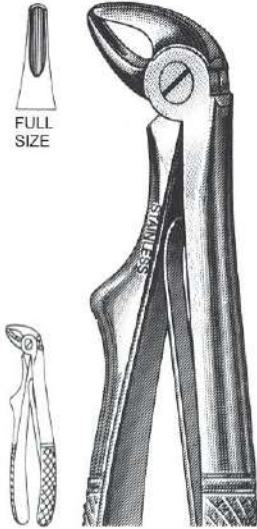

DNF B
Pedo Lower Root;
Universal; Mini

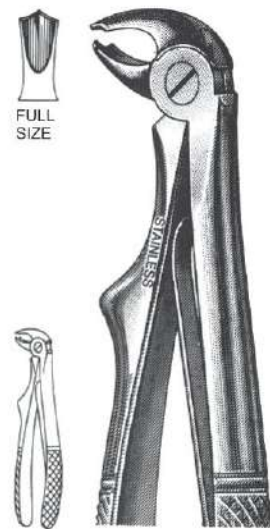

DNF C
Pedo Lower Molars; Universal; Mini

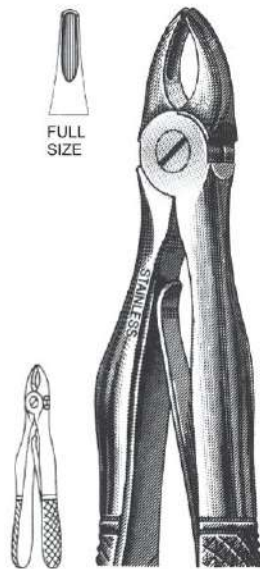

DNF E
Pedo Upper Front; Mini



DNF F
Pedo Upper Root;
Universal; Mini

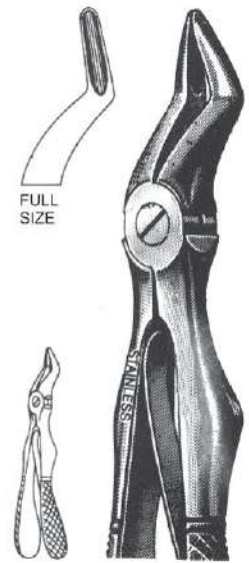

DNF H
Pedo Upper and Lower;
Universal; Mini

To obtain sure-grip serrated beaks specify 'SB' after forceps model number.

ELEVATORS



APICAL

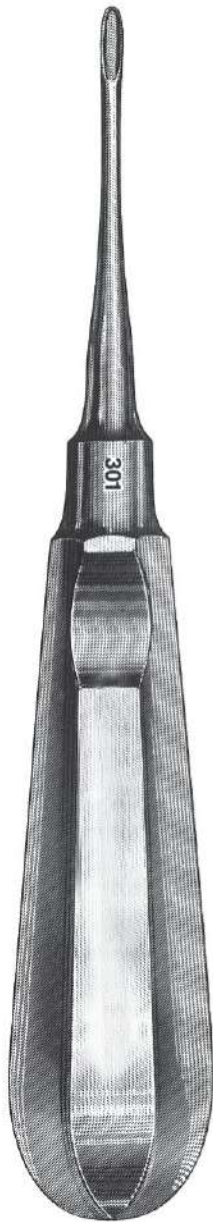

DNL 301



DNL 302



DNL 303



DNL 302 HF



DNL 303 HF

SELDIN



DNL 1L



DNL 1R



DNL 4L



DNL 4R

ELEVATORS



CRANE PICK

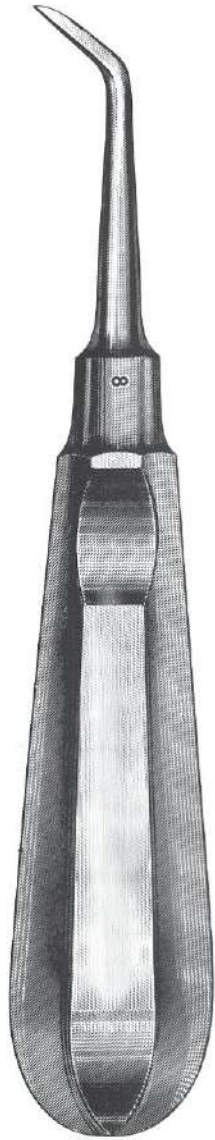

DNL 8



DNL 3



DNL 81



DNL A



DNL 34



DNL 34S



DNL 46

CRYER



DNL 44



DNL 45



DNL 25



DNL 26

ELEVATORS



ROOT TIP



DNL 78



DNL 79



DNL 80

HEIDBRINK ROOT-TIP PICKS



DNL H1



DNL H2



DNL H3

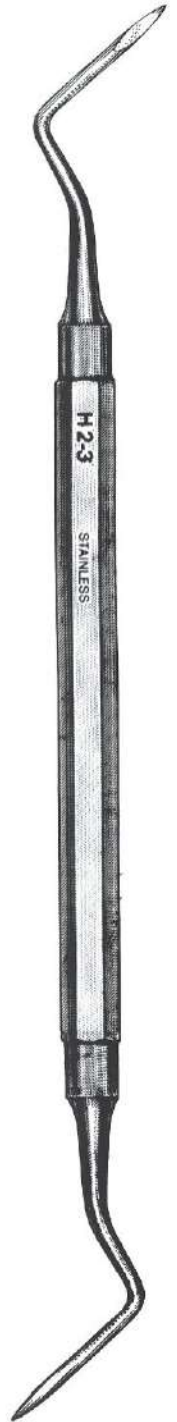

DNL H2-3

ELEVATORS



POTTS

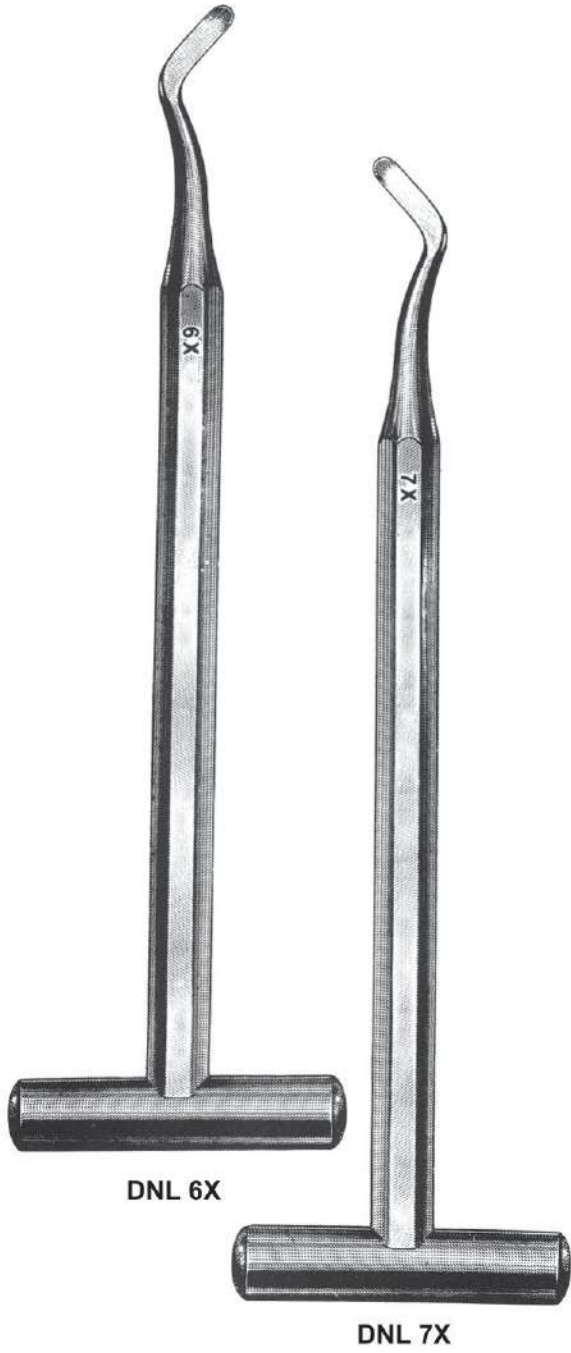

DNL 6X

DNL 7X

PERIOSTEAL

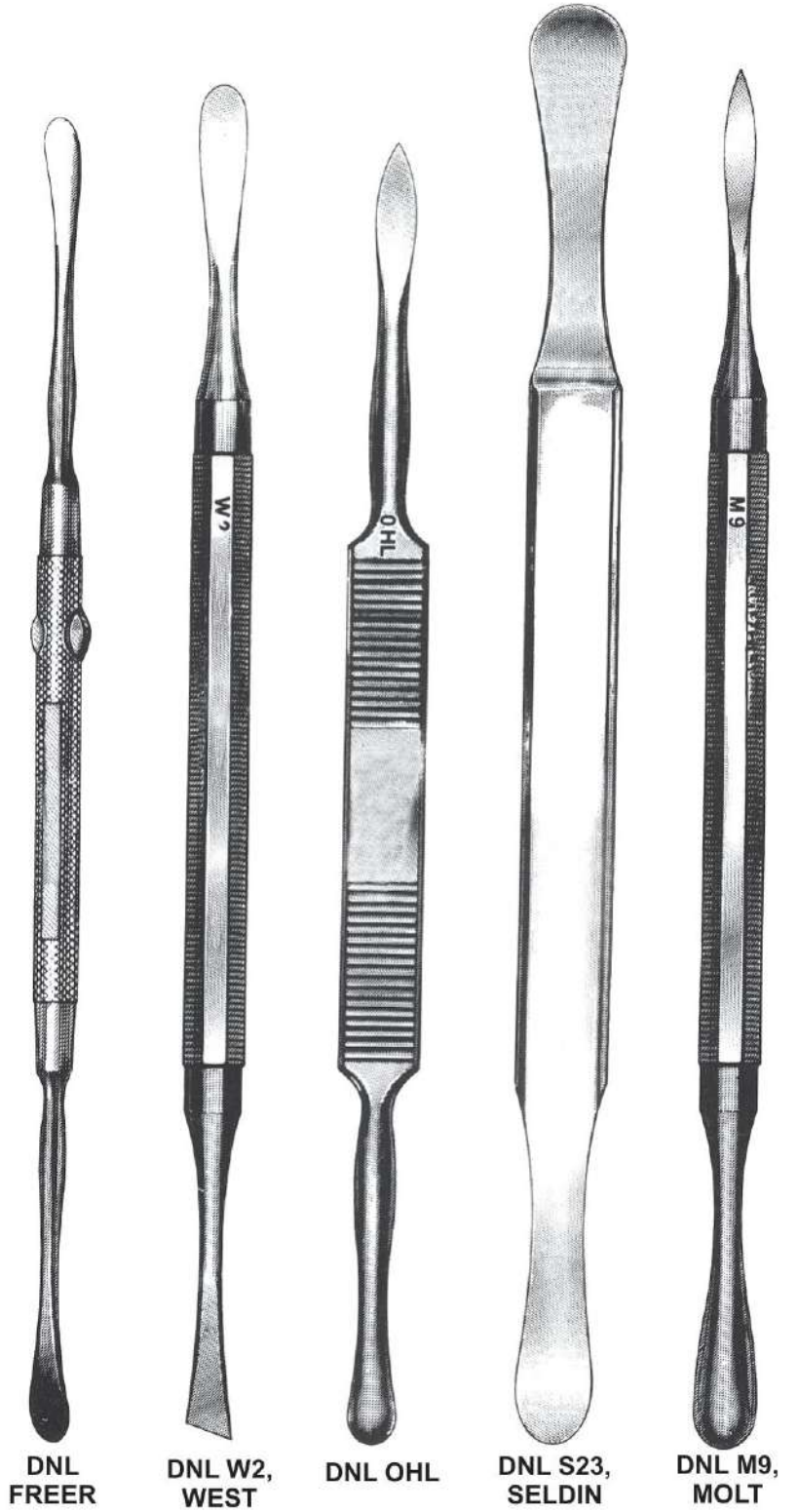

DNL
FREER

DNL W2,
WEST

DNL OHL

DNL S23,
SELDIN

DNL M9,
MOLT

Rongeurs

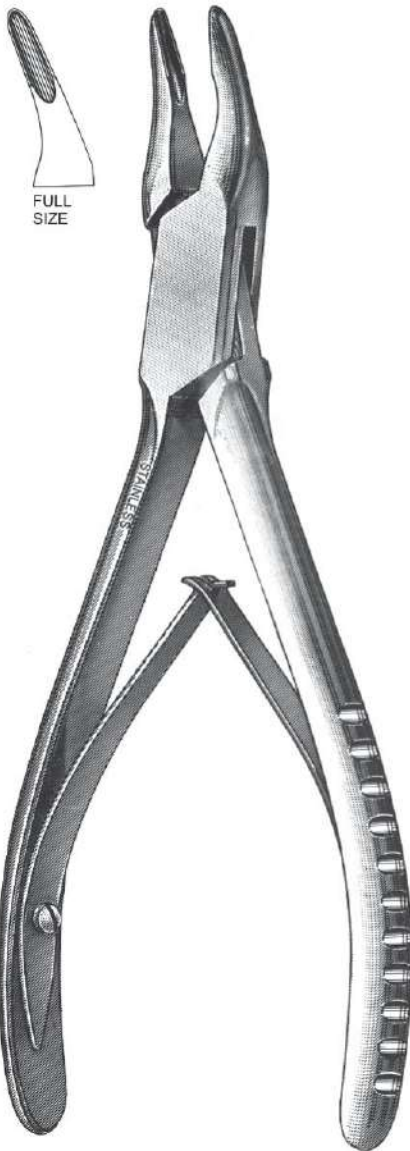

36-172
BLUMENTHAL 6"
30° Standard

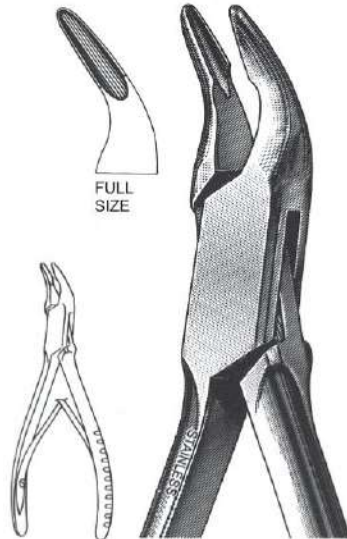

36-173
BLUMENTHAL 6" 45°

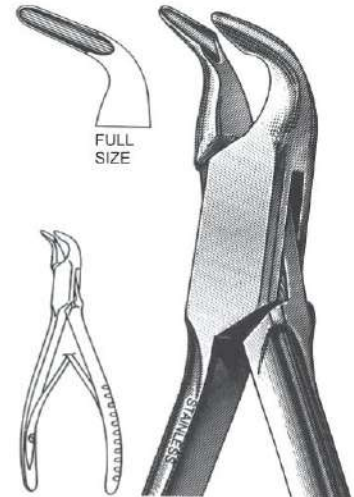

36-174
BLUMENTHAL 6" 90°

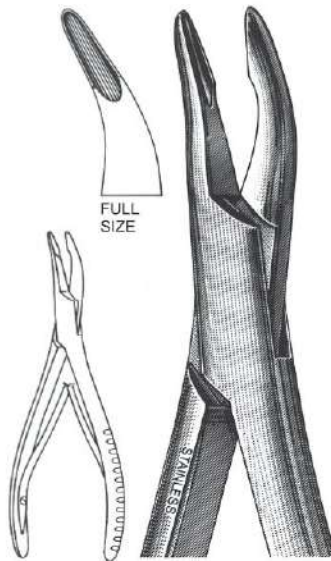

36-175
BLUMENTHAL 7" 30°

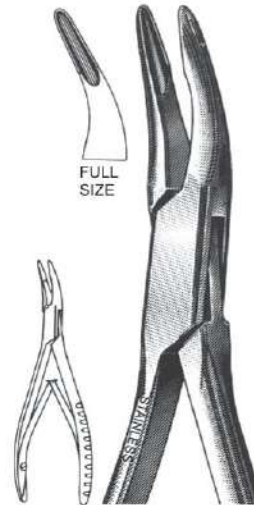

35-176
MINI-BLUMENTHAL
4 1/2" 30°

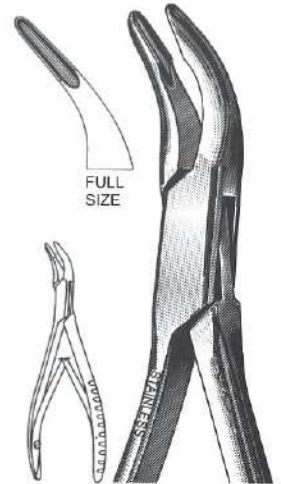

35-177
MINI-BLUMENTHAL
4 1/2" 45°

Rongeurs

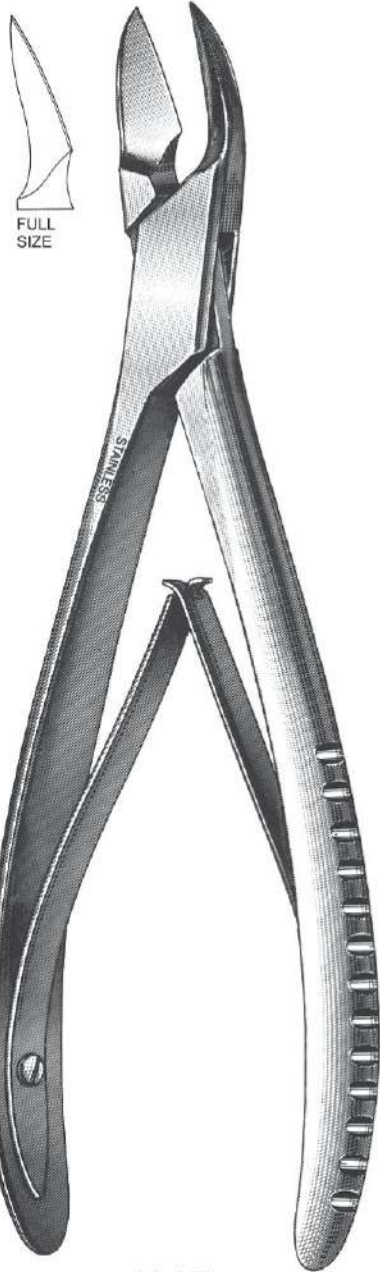

36-178
No. 5-Side Cutting, 6 3/4"

FULL
SIZE

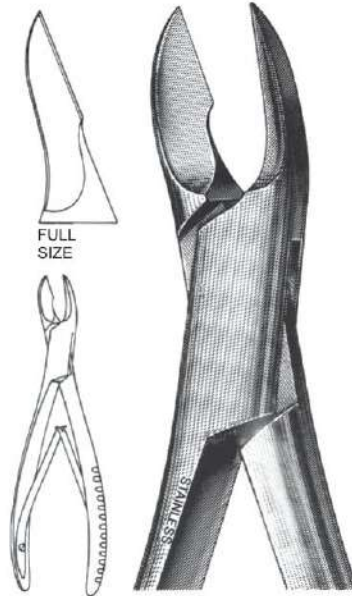

36-179
No. 5A-Side Cutting, 6 1/2"

FULL
SIZE

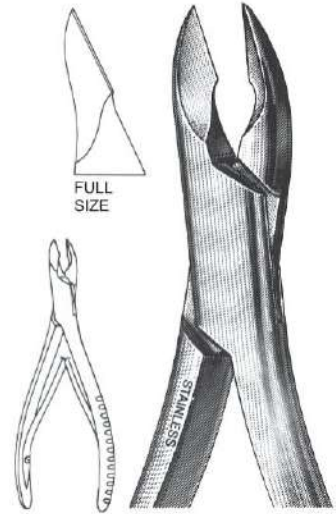

36-180
No. 5S-Side Cutting, 6"

FULL
SIZE

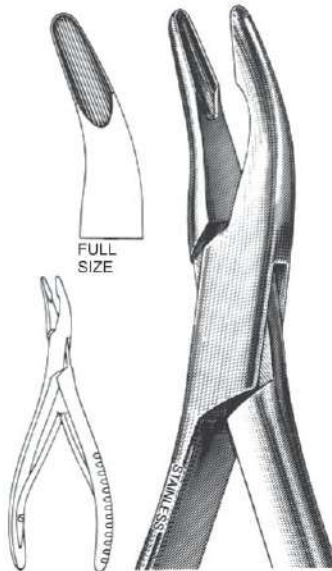

36-181
No. 1A-MEAD, 6 1/2"

FULL
SIZE

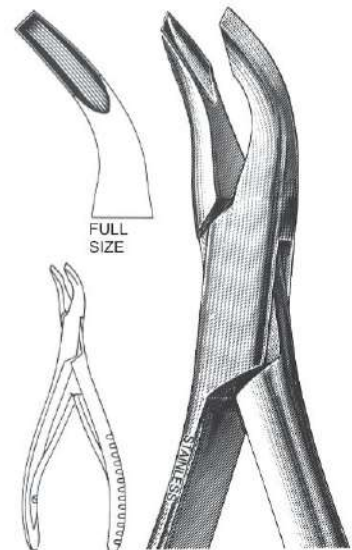

36-182
No. 2A-MEAD, Square
Tips, 6 1/2"

FULL
SIZE

Rongeurs

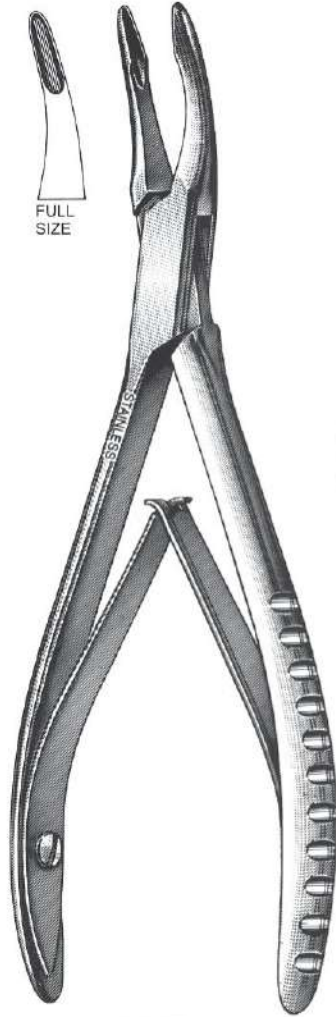
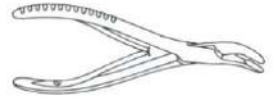

36-183
FRIEDMAN 5 1/2"



FULL
SIZE

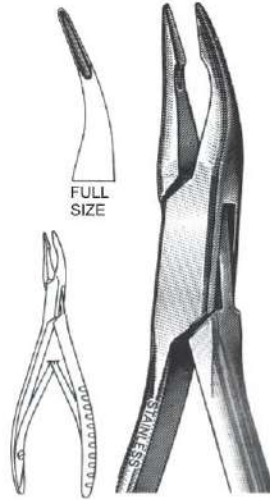

36-184
MICRO-FRIEDMAN 5 1/2"
15° Curved Jaws



FULL
SIZE

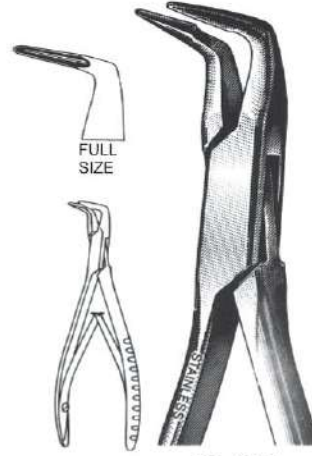

36-185
MICRO-FRIEDMAN 5 1/2"
90° Angled Jaws



FULL
SIZE

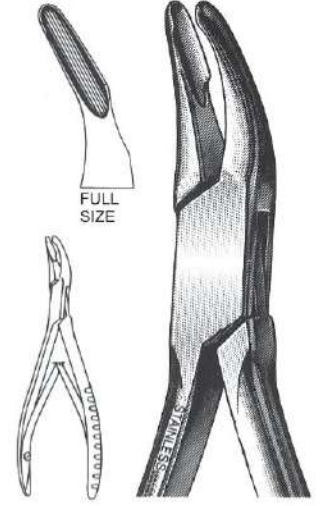

36-186
No. 4-5 1/2"



FULL
SIZE

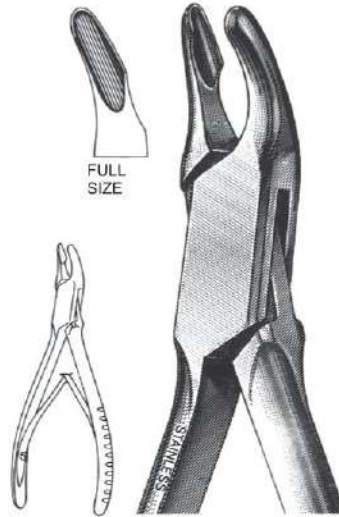

36-187
No. 4A-6 1/2"



FULL
SIZE

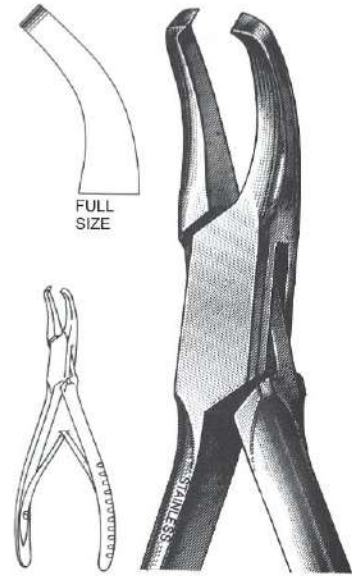

36-188
No 6A-End Cutting 6 1/2"



FULL
SIZE

Rongeurs



36-189
BEYER-Double Action, 7"



36-190
No. 1, 6 1/2"

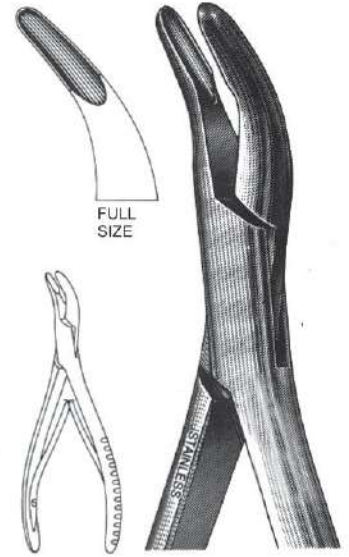

36-191
HARTMAN 5 3/4", Strong Curve

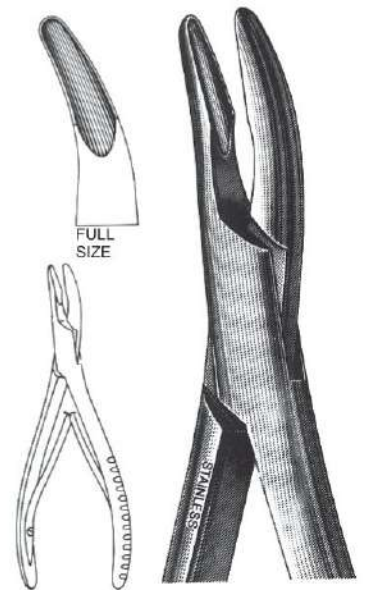

36-192
BANE 7", Slight Curve

Bone Currettes



LUCAS



MOLT

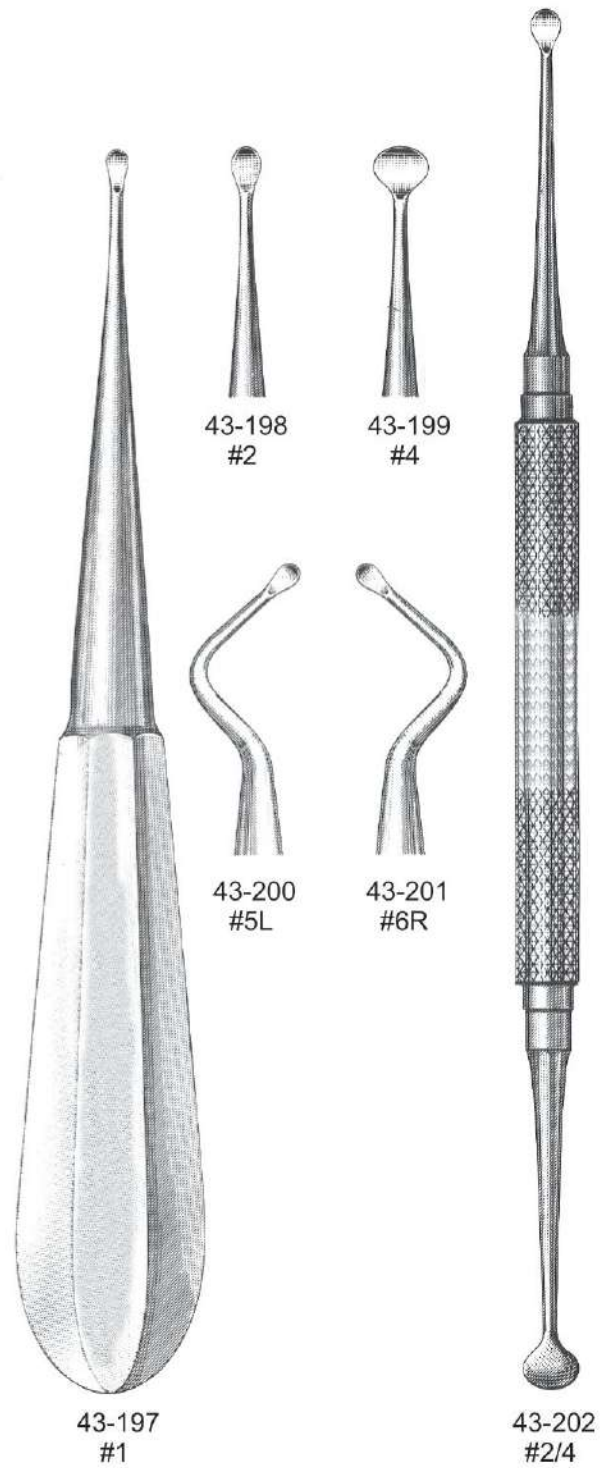

Bone Files



43-203
#10



43-204
#33



43-205
#64-MILLER

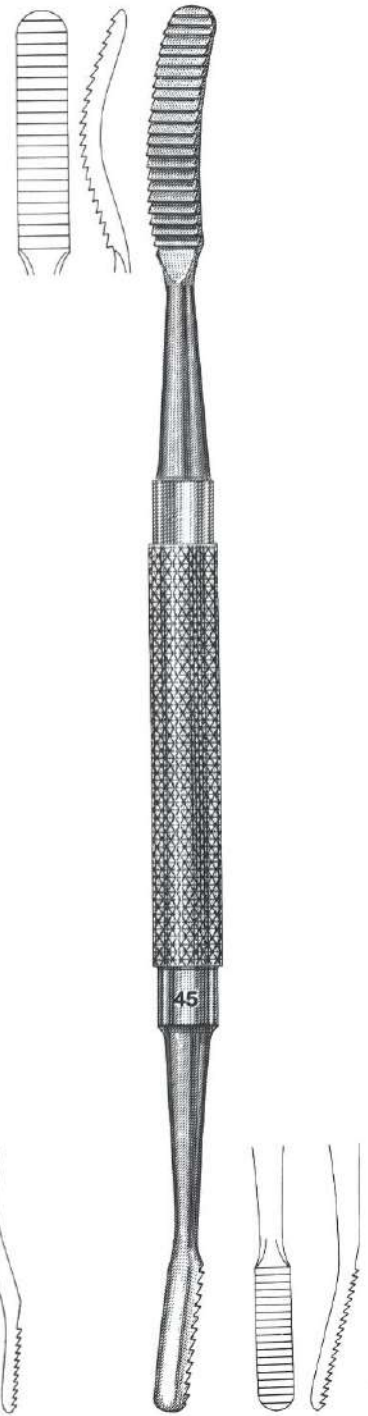

43-206
#45-MILLER

Bone Files

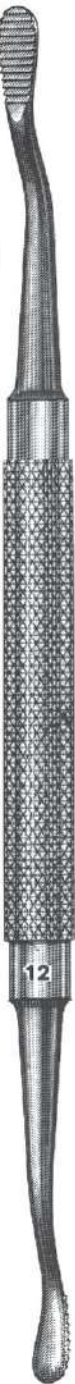
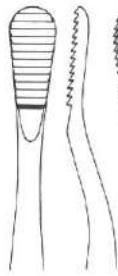

43-207
#12-HOWARD

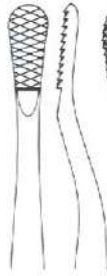

43-208
#12A



43-209
#12CA



43-210
#1-POLOKOFF

Bone Chisels



GARDNER



BUCKLEY



WAKEFIELD



43-211
Gardner
#1

43-212
Gardner
#2

43-213
Gardner
#5

43-214
Gardner
#5R

43-215
Gardner
#6

43-216
Buckley
#3

43-217
Wakefield
#1W

43-218
Wakefield
#2W

Mallets

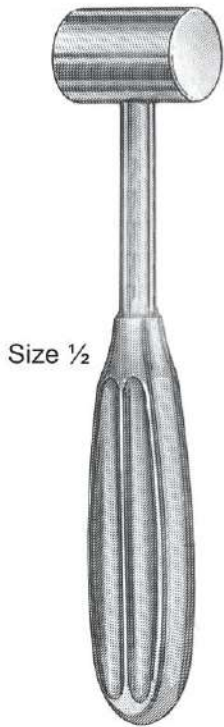

Size ½

44-219
GERZOG Mallet 7 ½"
head 8 oz. Lead filled with
stainless jacket

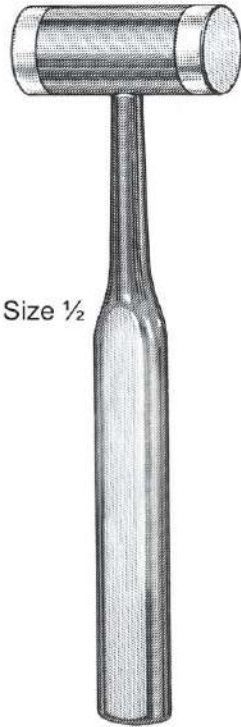

Size ½

44-220
Mallet 7 ½", lightweight 7.5 oz
stainless head 1" dia. With
2 replaceable nylon caps
44-221
Nylon Cap Replacement

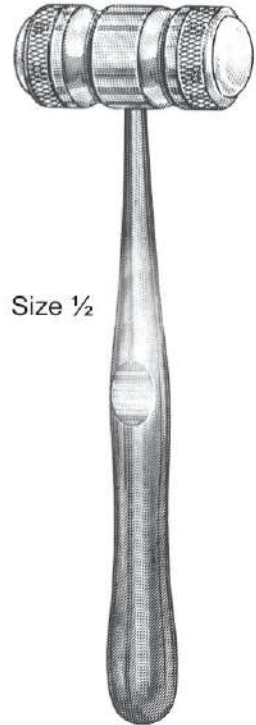

Size ½

44-222
MEAD Mallet 7 ½", head 8 oz.
With 2 replaceable nylon caps
44-223
Nylon Cap Replacement

Bone Holding Forceps



KERN

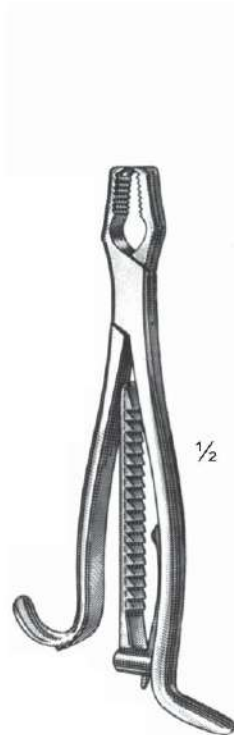

44-224
Baby Kern Bone Holding Forceps,
6", with ratchet

DINGMAN



44-225
DINGMAN Bone Forceps, 7 1/2",
angled on side, 2x2 teeth

Lip and Cheek Retractors

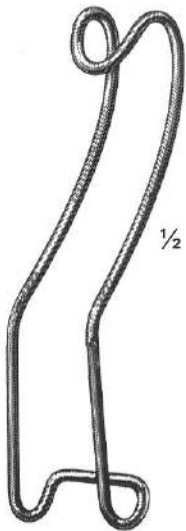

47-226
Lip Retractor 6"
double end 25mm and
36mm wide



47-227
Columbia Lip Retractor
5 1/2", double end 37mm and
50mm wide



47-228
University of Minnesota
Cheek Retractor



46-229
Cheek Retractor 7 3/4",
with swivel blade
35mm wide

Tongue Seizing Forceps and Tongue Depressors

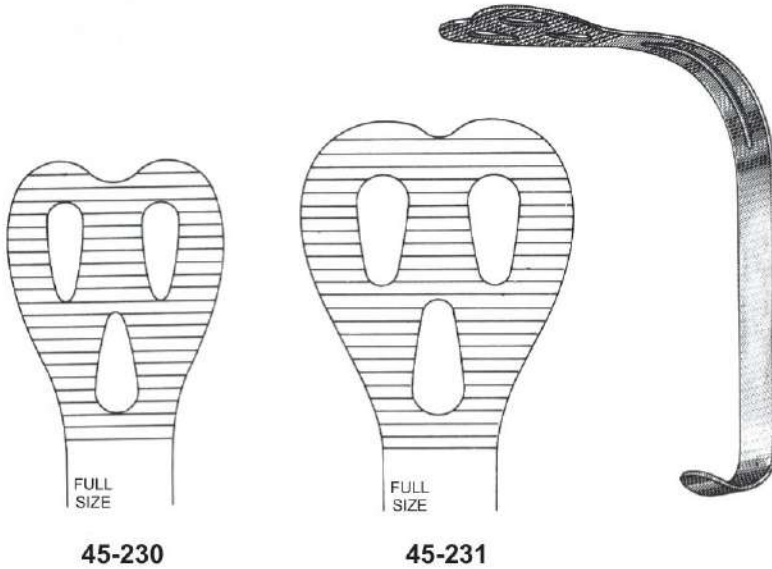

SIZE ½

45-230
WIEDER Tongue Depressor,
small blade 28mm wide,
serrated

45-231
WIEDER Tongue Depressor,
large blade 36mm wide,
serrated

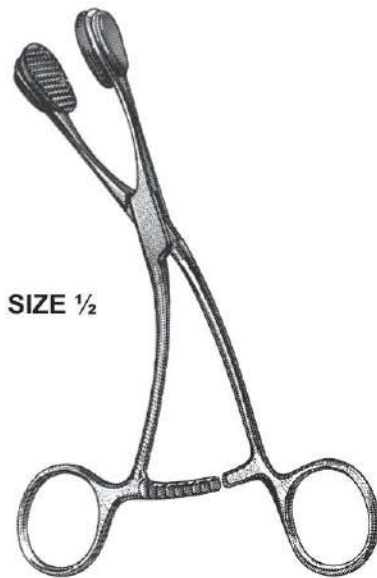

SIZE ½

45-232
YOUNG Tongue Seizing Forceps
45-233
Rubber Jaws-Replacement



SIZE ½

45-234
ANDREWS Tongue Depressor
serrated blade 21mm wide

Mouth Gags



SIZE ½

37-235
MOLT, PEDIATRIC



SIZE ½

37-236
MOLT, CHILD

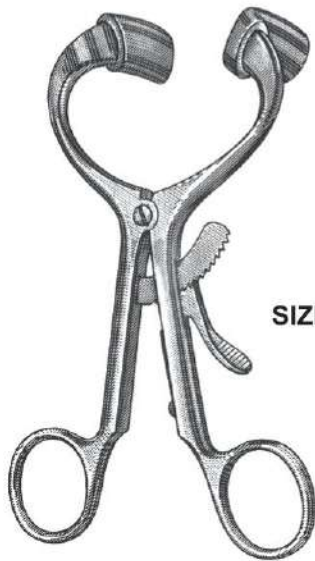

SIZE ½

37-237
MOLT, ADULT

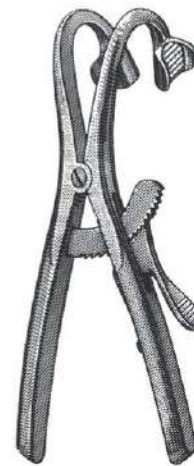

SIZE ½

37-238
DENHARDT

Gum Scissors



SIZE 1/2

38-239
DEAN 6 3/4", One
Serrated Blade



SIZE 1/2

38-240
HEATH 6 1/4", One
Serrated Blade

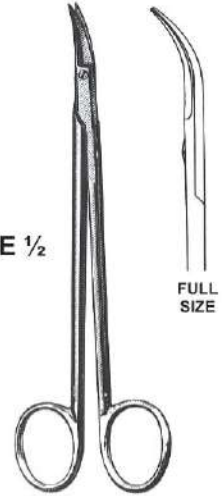

SIZE 1/2

FULL
SIZE

38-241
QUIMBY 5"
38-242
QUIMBY 5", One
Serrated Blade
(not illustrated)



SIZE 1/2

38-243
G-F 5", Curved Fine Tips,
One Serrated Blade



SIZE 1/2

5-243-TC
G-F 5", One Serrated
and One Tungsten carbide Blade

38-244
5", Double Curved,
One Serrated Blade

Gum Scissors



IRIS PATTERN



SIZE 1/2

38-245
3 1/2", Straight
Extra Delicate

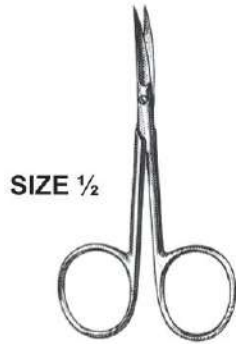

SIZE 1/2

38-246
3 1/2", Curved
Extra Delicate



SIZE 1/2

38-247
4", Straight



SIZE 1/2

38-248
4", Curved



SIZE 1/2

38-249
4 1/2", Straight



38-251
5 1/2", Curved, B/B



38-250
4 1/2", Curved



SIZE 1/2

38-252
5", Curved, B/B
Delicate

Gum Scissors



SIZE ½



38-253
IRIS 4 ½", Curved
Sideways



38-254
IRIS 4 ½", Angled
on Side



WAGNER 4 ¾", S/S
38-255 Straight, Smooth
38-256 Straight, One
Serrated Blade

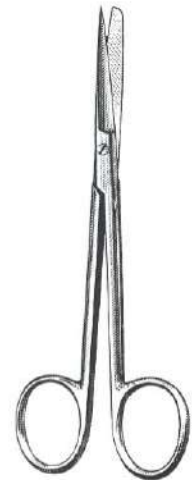

WAGNER 4 ¾", S/B
38-257 Straight, Smooth
38-258 Straight, One
Serrated Blade



WAGNER 4 ¾", B/B
38-259 Strt, Smooth
38-260 Straight, One
Serrated Blade

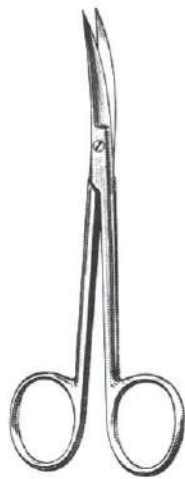

WAGNER 4 ¾", S/S
38-261 Curved, Smooth
38-262 Curved, One
Serrated Blade



WAGNER 4 ¾", S/B
38-263 Curved, Smooth
38-264 Curved, One
Serrated Blade



WAGNER 4 ¾", B/B
38-265 Curved, Smooth
38-266 Curved, One
Serrated Blade

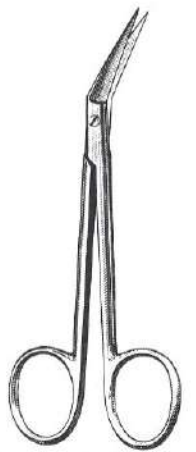

WAGNER 4 ¾", S/S
38-267 Ang., Smooth
38-268 Angular, One
Serrated Blade

Gum Scissors



38-270
LA GRANGE, 4 1/4", Impro
One Serrated Blade

SIZE 1/2

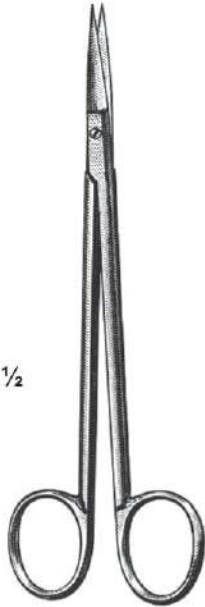

KELLY 6 1/4", S/S
38-271 Straight, Smooth
38-272 Straight, One
Serrated Blade



KELLY 5 3/4", S/S
38-273 Curved, Smooth
38-274 Curved, One
Serrated Blade



KELLY 6 1/4", S/S
38-275 Angular, Smooth
38-276 Angular, One
Serrated Blade



JOSEPH 5 3/4", S/S
38-277 Straight, Smooth
38-278 Curved, Smooth



SULLIVAN 5 1/2", S/S
38-279 Straight, Smooth

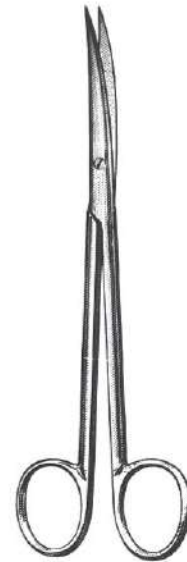

SULLIVAN 5 1/2", S/S
38-280 Curved, Smooth
38-281 Curved, One
Serrated Blade

Gum and Bandage Scissors



38-282
ROSS, 4 3/4", Curved,
Periodontal



38-283
CASTROVIEJO, 3 1/2",
Curved, Reriodontal

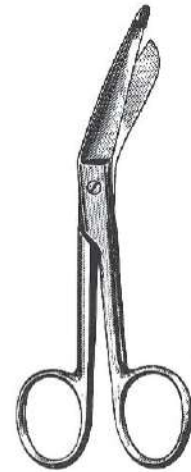

LISTER BANDAGE
38-286 4 1/2"
38-287 5 1/2"
38-288 7 1/4"

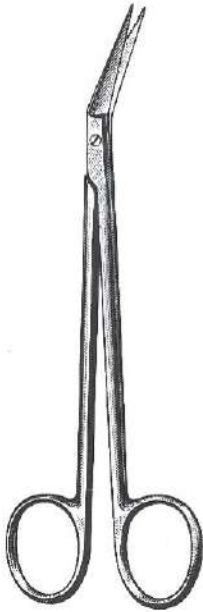

38-284
LOCKLIN 6 1/4"
Straight Shanks,
One Serrated Blade



38-285
LOCKLIN 6 1/4",
Curved Shanks,
One Serrated Blade

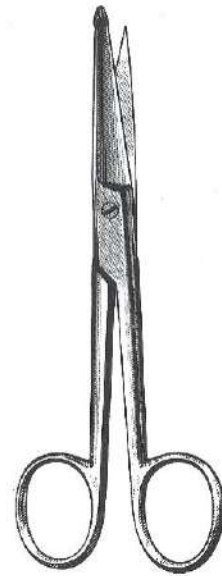

38-289
KNOWLES BANDAGE 5 1/2"

Surgical Scissors



Size 1/2

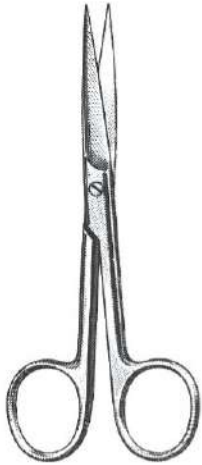

38-290
4 1/2", Straight, S/S
38-291
5 1/2", Straight, S/S



38-292
4 1/2", Straight, S/B
38-293
5 1/2", Straight, S/B

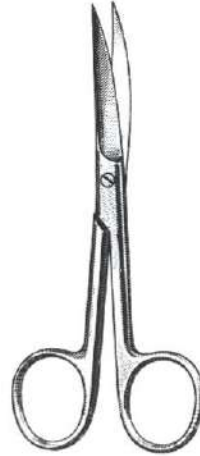

38-294
4 1/2", Curved, S/S
38-295
5 1/2", Curved, S/S

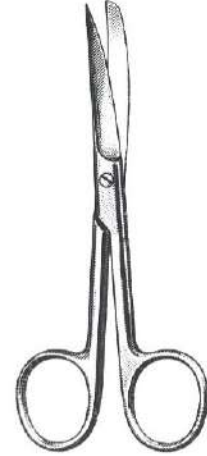

38-296
4 1/2", Curved, S/B
38-297
5 1/2", Curved, S/B



38-298
MAYO 5 1/2", Straight



38-299
MAYO 5 1/2", Curved

Suture Scissors

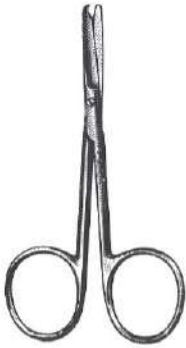

NS 38-300
SPENCER 3 1/2"



NS 38-301
LITTAUER JR., 4 1/2"

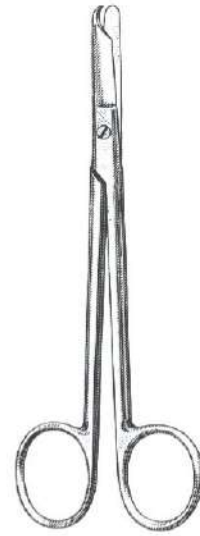

NS 38-302
LITTAUER
STANDARD, 5 1/2"



NS 38-303
SHORTBENT 3 1/2"



NS 38-304
NORTHBENT 4 3/4"



NS 38-305
NS 4 1/2", Angular
(Also ideal for cutting
retraction cord)



NS 38-306
LONG 6 1/4"

Collar and Crown, Wire Cutting Scissors



Size ½

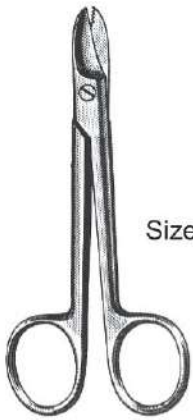

Size ½

38-307
4 ¼", Straight,
One Serrated Blade
38-308
4 ¼", Straight, Smooth

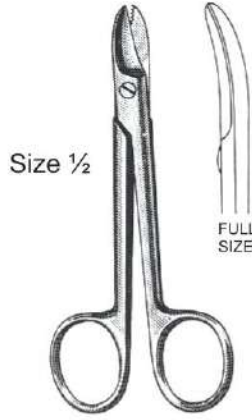

Size ½

38-309
4 ¼", Curved,
One Serrated Blade
38-310
4 ¼", Curved, Smooth



Size ½

38-311
4 ¾", Straight,
One Serrated Blade
38-312
4 ¾", Straight, Smooth

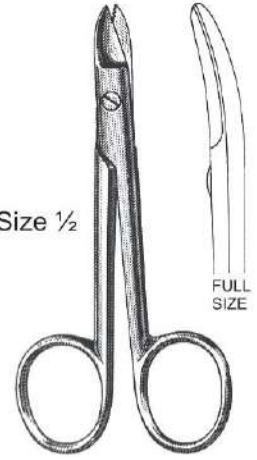

Size ½

38-313
4 ¾", Curved,
One Serrated Blade
38-314
4 ¾", Curved, Smooth

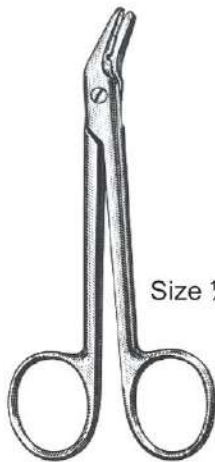

Size ½

38-315
4 ¾", Angular With Wire Cutter,
One Serrated Blade

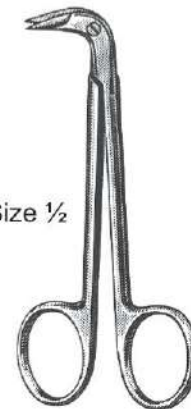

Size ½

38-316
RA Matrix 4 ¼",
One Serrated Blade

Tissue Forceps



Size ½

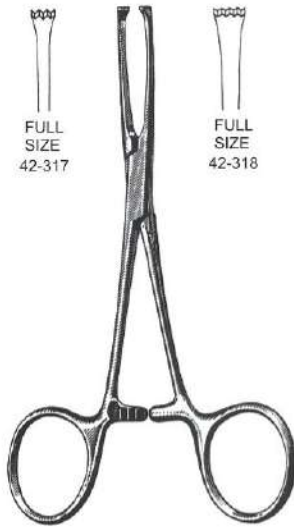

BABY ALLIS
 42-317 5", straight, 4x5, teeth Extra delicate
 42-318 5 ½", straight, 4x5 teeth

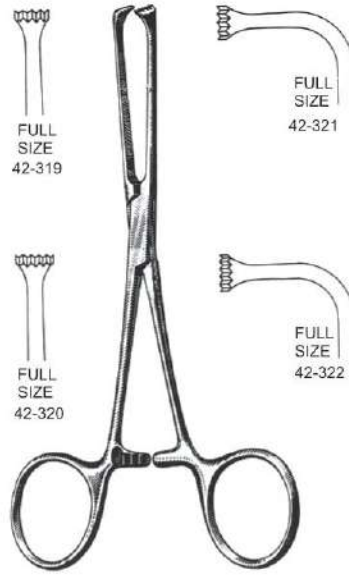

ALLIS
 42-319 6", Straight, 4x5 teeth
 42-320 6", Straight, 5x6 teeth
 42-321 6", Angular, 4x5 teeth
 42-322 6", Angular, 5x6 teeth



42-323 5 ½", Tissue, 1x2 teeth
 42-324 6", Tissue, 1x2 teeth



SEMKIN
 42-325 6", straight, 1x2 teeth
 42-326 5", curved, 1x2 teeth (Not Illus.)



42-327
ADSON 4 ¾", 1x2 teeth



42-328
BROWN-ADSON 4 ¾", 7x7 teeth



42-329
BROWN 6", 8x8 teeth



RUSSIAN
 42-330 6"
 42-331 8"



42-332
 Extra-Delicate, 4" straight, 1x2 teeth

Dressing Forceps and Furnace Tongs



42-333 5 1/2", Dressing
42-334 6", Dressing



42-335
SEMKIN 5", Serrated
42-336
SEMKIN 6", Serrated



Size 1/2

42-337
6", Dressing, delicate,
Cross Serrated
T-Carbide Jaws



42-338
4", Dressing, Extra
dedicate tips



42-339
ADSON 4 3/4",
Dressing



42-340 TC
ADSON 4 3/4",
Dressing, T-Carbide Jaws



42-341 A
ADSON 4 3/4",
Dressing, Angled Jaws



FURNACE TONGS
42-342 10"
42-343 12"

Tissue Retractors and Hooks



Size 1/2



48-344
3 Sharp Prongs



48-345
6", 2 Sharp Prongs
48-346
6", 3 Sharp Prongs



48-347
6", 2 Sharp Prongs
48-348
6", 3 Sharp Prongs



48-349
SENN 6 3/8"
3 Sharp Prongs



48-350
5 1/2"
Tissue Fixator



48-351
FRAZIER 5", Sharp
48-352
FRAZIER 5", Blunt

Towel Clamps and Napkin Holders



Size ½



49-353
JONES 3 ½"

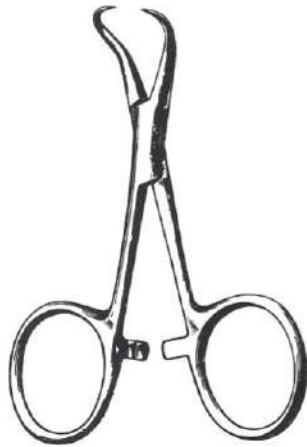

49-354
BACKHAUS 3 ½"

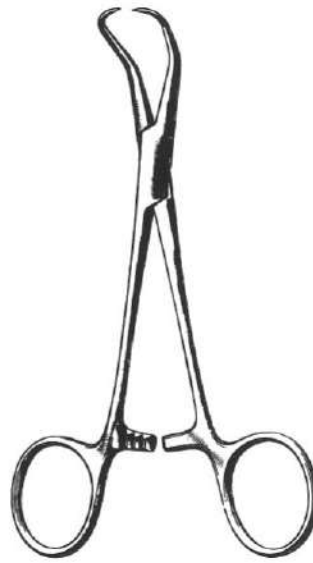

49-355
BACKHAUS 5 ¼"



NON-PERFORATING
49-356
LORNA 3 ½"
49-357
LORNA 5 ¼"
(Good on Paper Drapes)

Hemostatic Forceps



Size ½

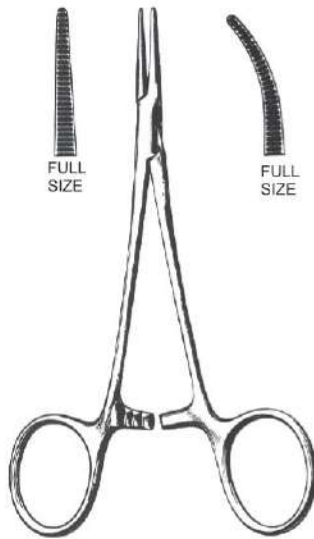

39-358
HALSTED Mosquito 5"
Straight
39-359
HALSTED Mosquito 5"
Curved

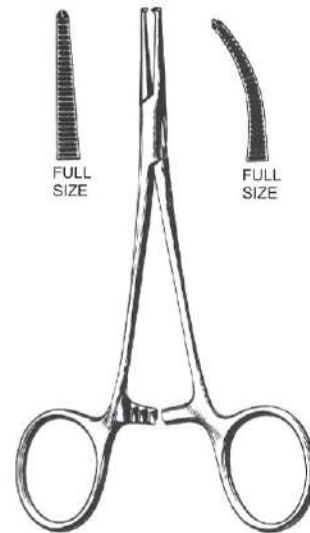

39-360
HALSTED Mosquito 5"
Straight, 1x2 Teeth
39-361
HALSTED Mosquito 5"
Curved, 1x2 Teeth

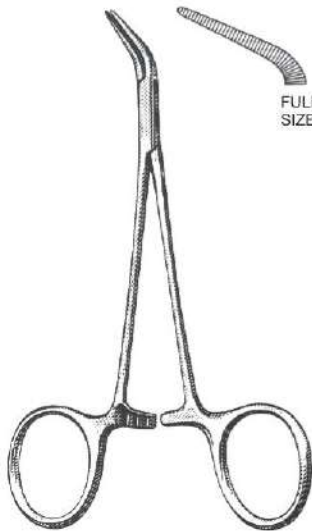

39-362
HALSTED Mosquito 5"
Jaws 45° Angled On Flat
Extra Delicate

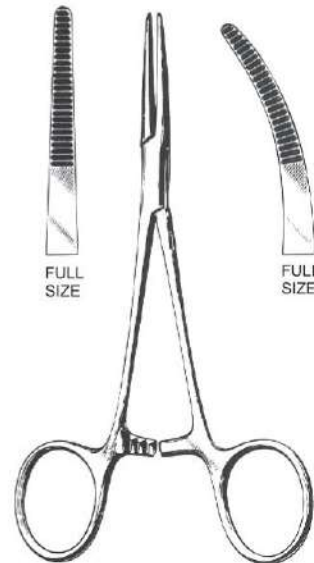

39-363
KELLY 5 ½"
Straight
39-364
KELLY 5 ½"
Curved

Needle Holders



Size ½



40-365
COLLIER 5"
Fenestrated Jaws



40-366
DERF 4 ¾"

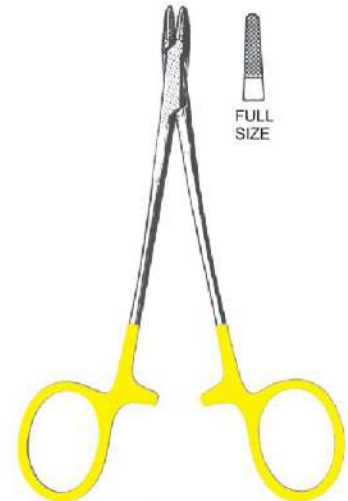

40-367
DERF 4 ¾"
T-Carbide Jaws



40-368
WEBSTER 5"
Delicate Smooth Jaws



40-369 TC
HALSEY 5"
T-Carbide Smooth Jaws
40-370 TC
HALSEY 5"
T-Carbide Serrated Jaws

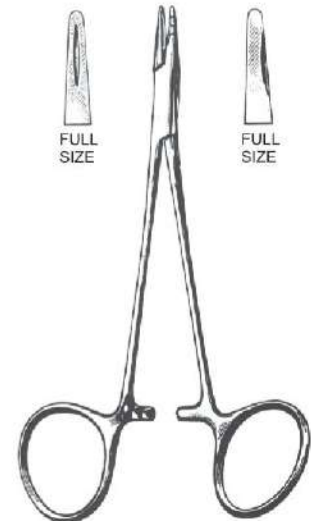

40-371
NEIVERT 5"
One Offset Ring

Needle Holders



40-372
OLSEN-HEGAR 5 1/2"
40-373
OLSEN-HEGAR 6 1/2"

Size 1/2



40-374 TC
OLSEN-HEGAR 5 1/2"
T-CARBIDE JAWS
40-375 TC
OLSEN-HEGAR 6 1/2"
T-CARBIDE JAWS



40-376
BOYNTON 5"

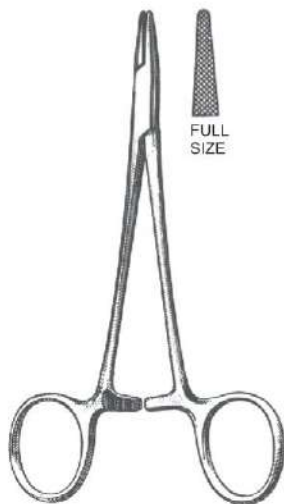

40-377
GARDNER 5"



40-378
MATHIEU 5 1/2"
40-379
MATHIEU 6 1/4"



40-380 TC
MATHIEU 5 1/2"
T-CARBIDE JAWS

Needle Holders



40-381
BAUMGARTNER 5 1/2"

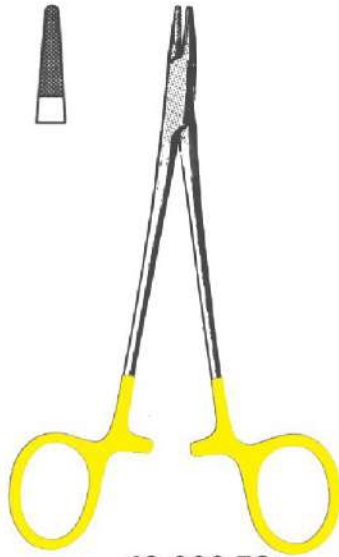

40-382 TC
BAUMGARTNER 5 1/2"
T-Carbide Jaws



40-383
MAYO-HEGAR 5"
40-384
MAYO-HEGAR 6"



40-385 TC
MAYO-HEGAR 5"
40-386 TC
MAYO-HEGAR 6"
T-Carbide Jaws

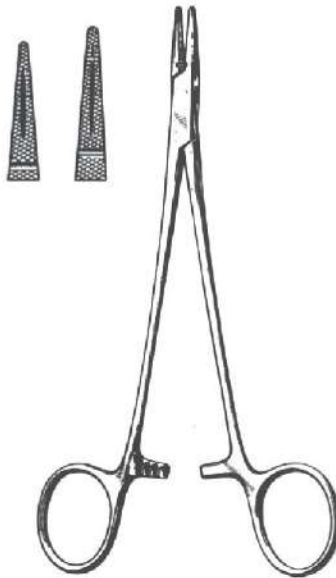

40-387
CRILE-WOOD 6"
40-388
CRILE-WOOD 7"



40-389
CRILE-WOOD 6"
T-Carbide Jaws

Needle Holders

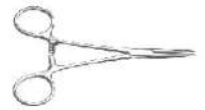

40-390 TC
CRILE-WOOD 7"
T-Carbide Jaws

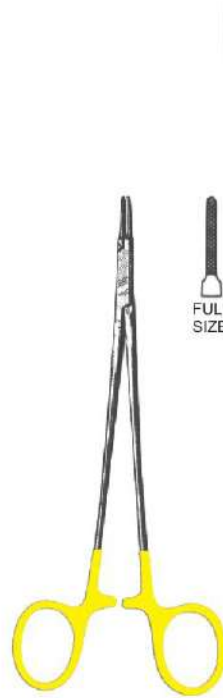

40-391 TC
RYDER-Type 5"
T-Carbide Jaws



40-392
CRILE 6"



40-393
RYDER 6"
T-Carbide Jaws



40-394
WEBSTER 5" Quick Release,
Smooth T-Carbide Jaws

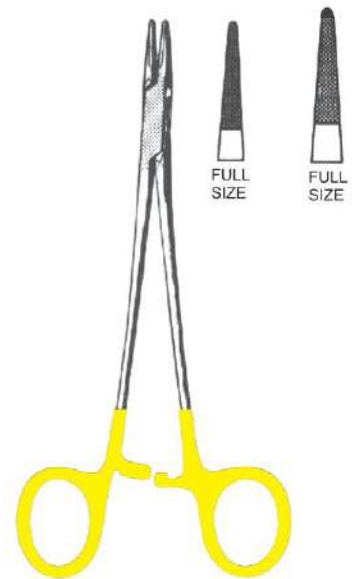

40-395 TC
CRILE-WOOD 6", Quick Release,
T-Carbide Jaws
40-396 TC
CRILE-WOOD 7", Quick Release,
T-Carbide Jaws

Needle Holders



SIZE ½



40-397
CASTROVIEJO 5 ½"
Smooth Jaws

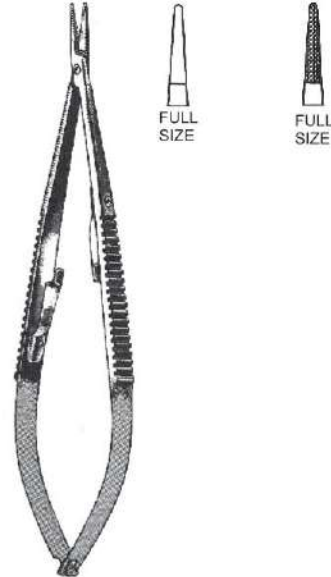

40-398
CASTROVIEJO 5 ½", Straight, Smooth
T-Carbide Jaws

40-399
CASTROVIEJO 5 ½", Straight, Serrated
T-Carbide Jaws



40-400
CASTROVIEJO 5 ½", Curved, Smooth
T-Carbide Jaws

40-401
CASTROVIEJO 5 ½", Curved, Serrated
T-Carbide Jaws



40-402
STEVENS 6 ½"

Impression Trays



Upper

41-403-AB
Non Perforated Rim Lock
Sizes: XS, S, M, L, XL
Also Available in set of 10 pcs.

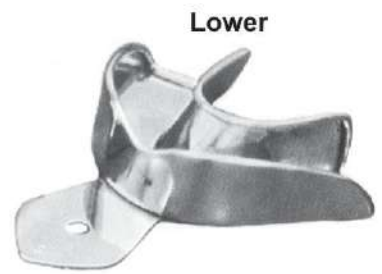

Lower

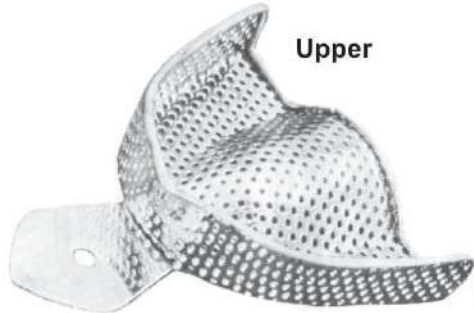

Upper

41-404-AB
Perforated Rim Lock
Sizes: XS, S, M, L, XL
Also Available in set of 10 pcs.



Lower

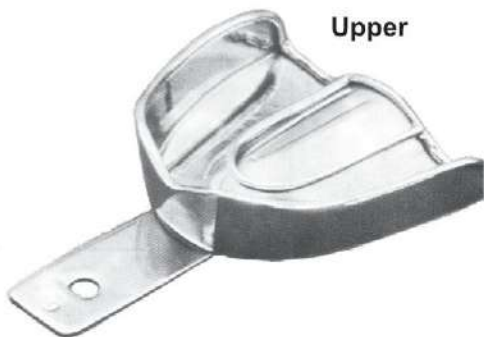

Upper

41-405-AB
Non Perforated Rim Lock
Sizes: XS, S, M, L, XL
Also Available in set of 6 & 12 pcs.



Lower



Upper

41-406-AB
Perforated Rim Lock
Sizes: XS, S, M, L, XL
Also Available in set of 6 & 12 pcs.



Lower

Impression Trays

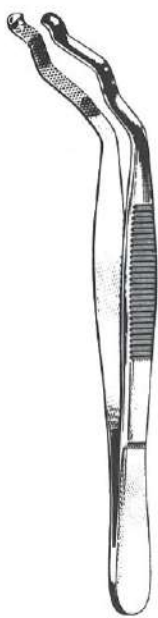
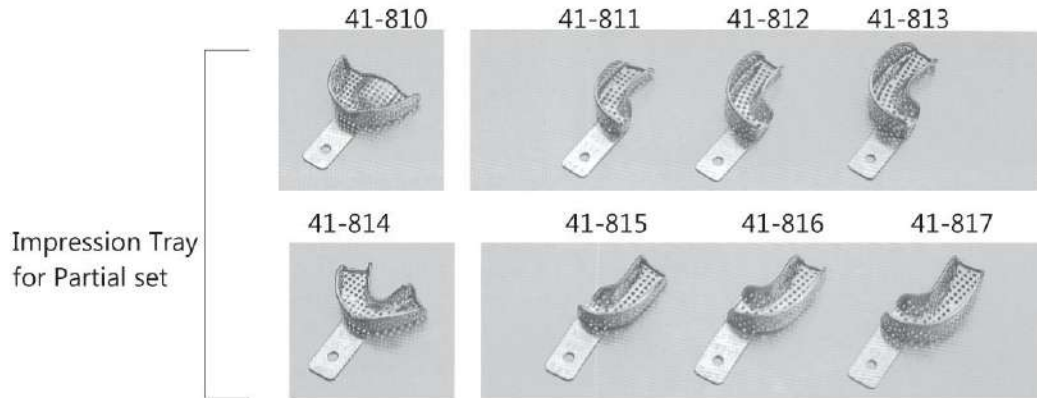

41-407
DAVIS 6"
41-408
DAVIS 10"

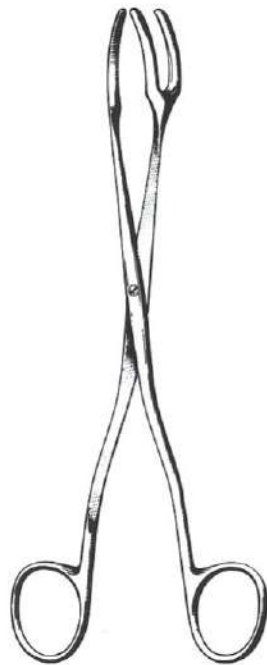

41-409
THREE-PRONG 8"

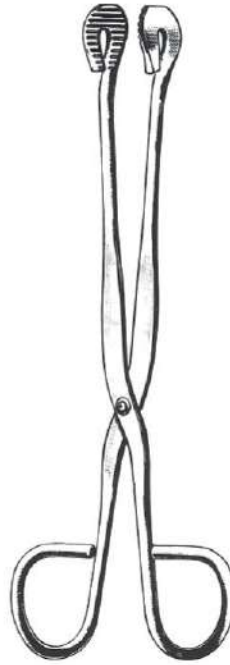

41-410
UTILITY 8"
Straight
41-411
UTILITY 11"
Straight

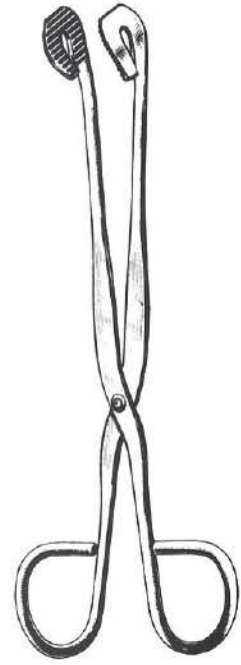

41-412
UTILITY 8"
Curved
41-413
UTILITY 11"
Curved

Cotton and Dressing Pliers



COLLEGE



46-418
Standard Tips,
Serrated



46-419
Standard Tips,
Smooth



46-420
Extra Fine Tips,
Serrated



46-421
Extra Fine Tips,
Long, Serrated



46-422
Standard Tips,
Non-Pinch,
Serrated



46-423
Extra Fine Tips,
Long, Non-Pinch,
Serrated



46-424
Forked Tips,
Smooth



46-425
MERIAM



46-426
PERRY
Curved Tips



46-427
PERRY
Angled Tips



46-428
SELF-LOCKING
Serrated Tips



46-429
SELF-LOCKING
Grooved Tips

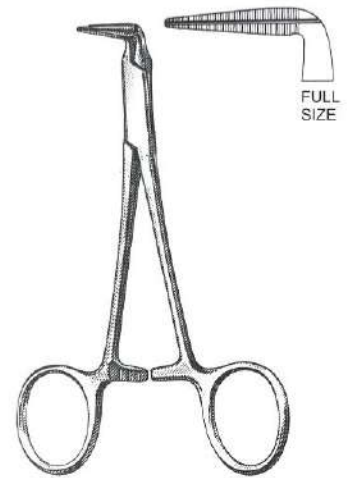

46-430
SILVER-POINT HOLDING
Grooved Tips

Dressing Pliers 1/2 size

Mouth Mirrors And Handles



CONE SOCKET

- 46-431 Regular, Plane, 3,4 and 5
- 46-432 Regular, Magnifying, 3,4 and 5
- 46-433 FRONT-SURFACE, 3,4 and 5



SIMPLE STEM

- 46-434 Regular, Plane, 3,4 and 5
- 46-435 Regular, Magnifying, 3,4 and 5
- 46-436 FRONT-SURFACE, 3,4 and 5



- 46-437 Octagonal, Cone Socket
- 46-438 Octagonal, Simple Stem



- 46-439 Deluxe, Cone Socket
- 46-440 Deluxe, Simple Stem



- 46-441 Octagonal, Cone Socket, with Millimeter Rule



- 46-442 Double Ended for Cone Socket Points



- 46-443 # 4 and 5, White
- 46-444 # 4 and 5, Blue

Gauges And Dividers



1/2

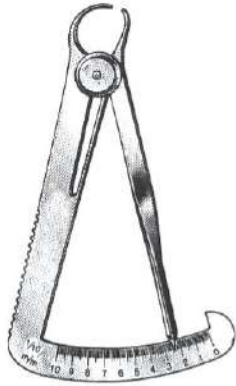

46-445
Crown Gauge, Improved
Model with 2 Sided Scale

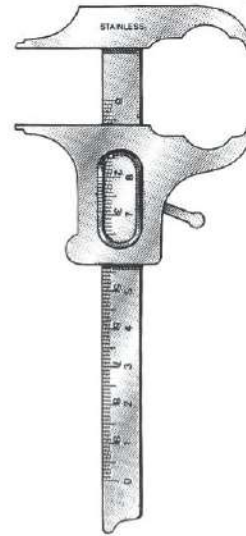

46-446
BOLEY Gauge,
STAINLESS



46-447
Spring Bow Divider
4 1/2" Radius



46-448
Spring Bow Divider
6" Radius

Shown 1/2 size

Explorers



50-449
(1DE)

50-450
(2DE)

50-451
(3DE)

50-452
(5DE)

50-453
(6DE)

50-454
(7DE)

50-455
(3A SE)

50-456
(6SE)

50-457
(7SE)

50-458
(17SE)

50-459
(23SE)

Explorers

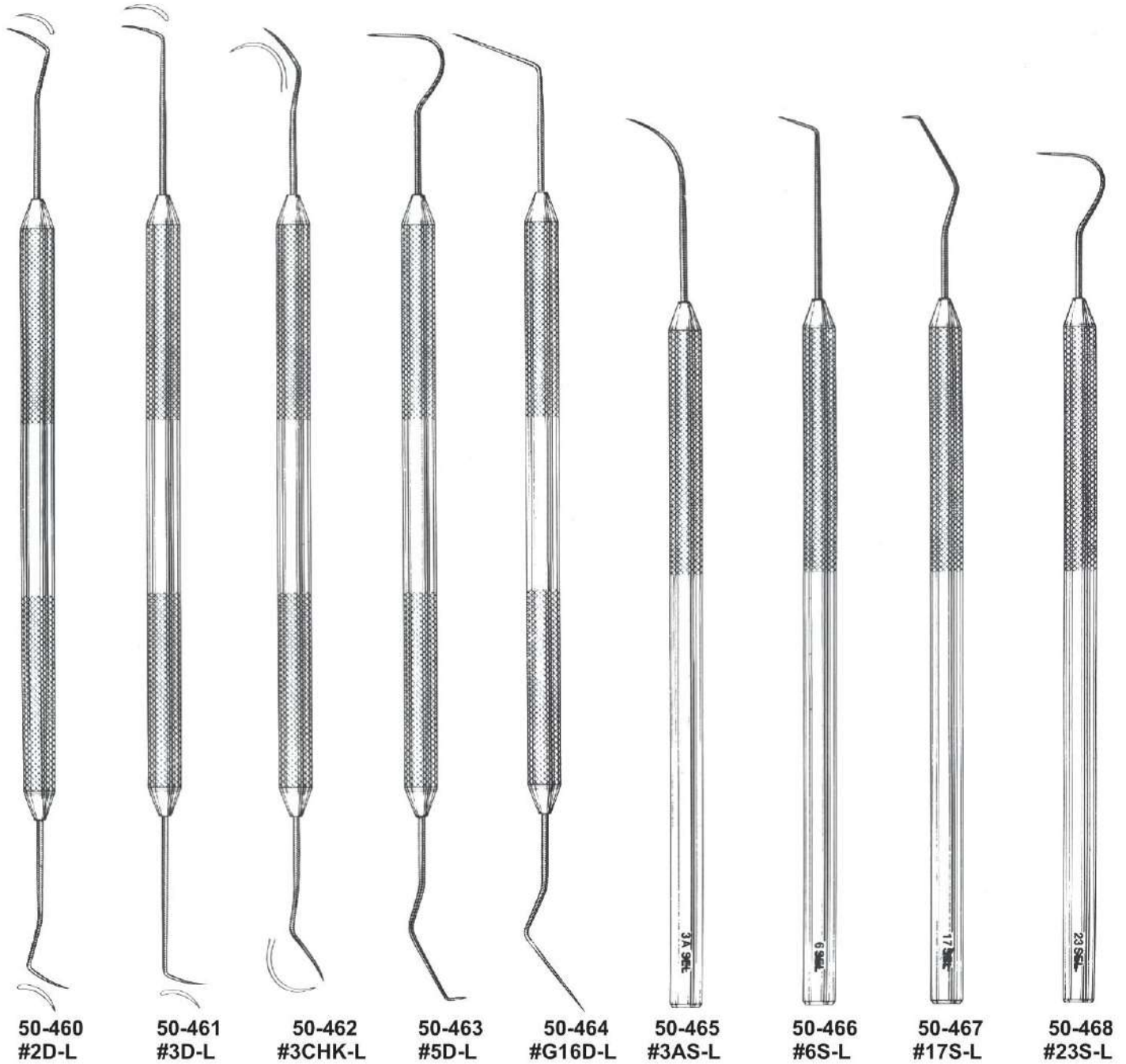

Probes and Explorer/Probes



50-469
Probe/Explorer
(GF 17)

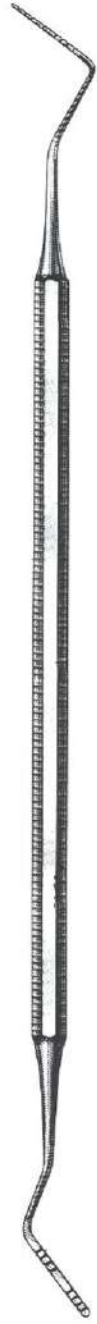

50-470
Probe
(GF 18)

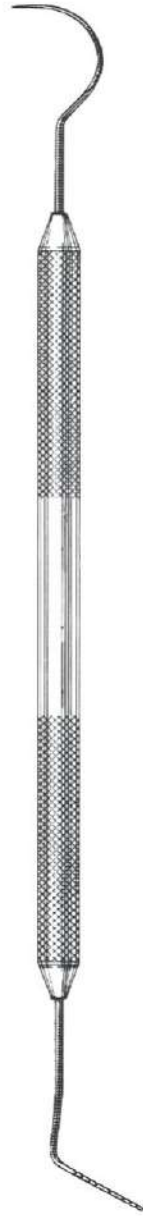

50-471
Probe/Explorer
(PE 1-23)



50-472
Probe
(C)



50-473
Probe
(X2)

Excavators

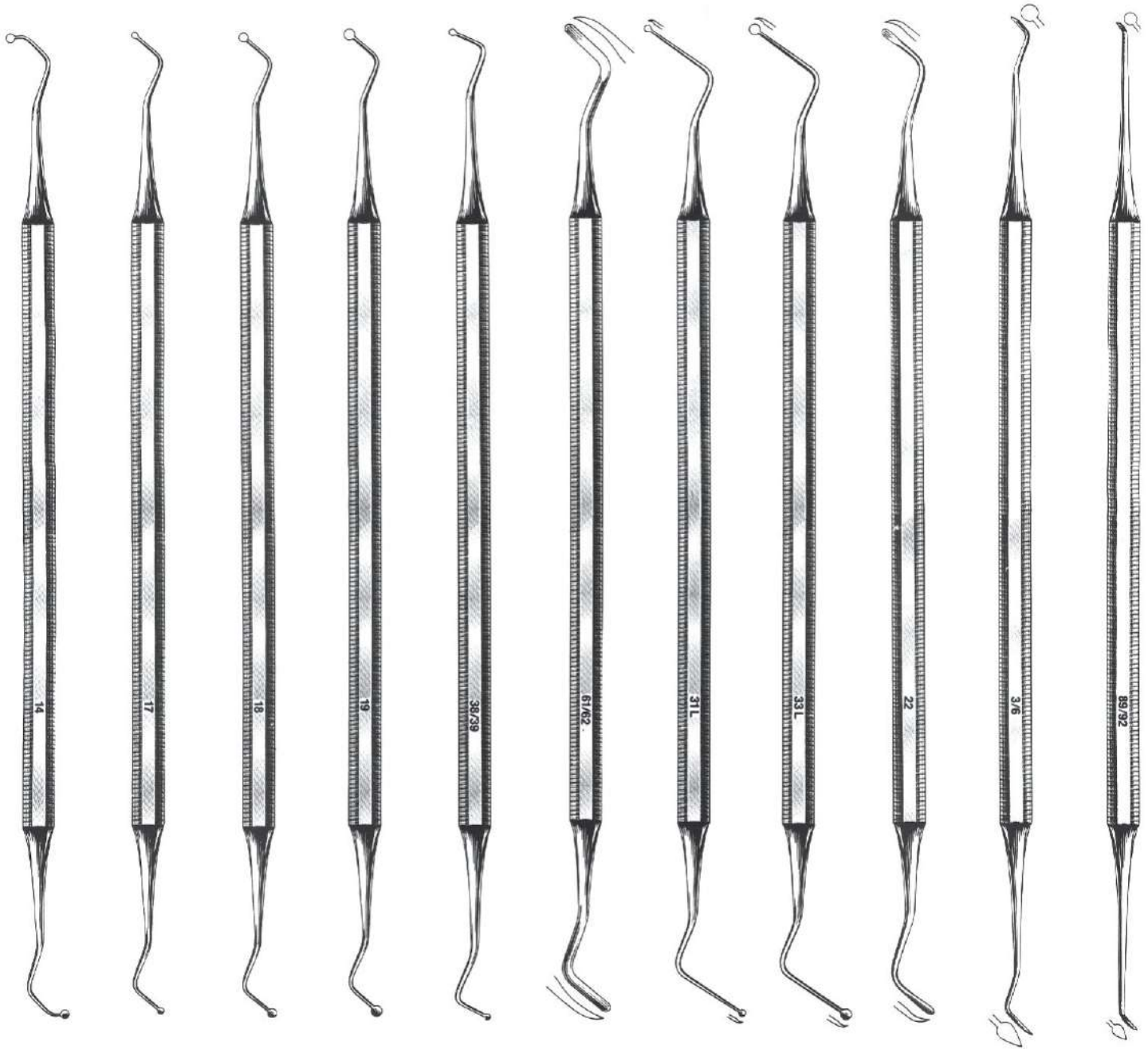

50-474
#14

50-475
#17

50-476
#18

50-477
#19

50-478
#38/39

50-479
#61/62

50-480
#31L

50-481
#33L

50-482
#22

50-483
#3/6
Cleoid/
Discoid

50-484
#89/92
Cleoid/
Discoid

Curettes



GRACEY



50-485
(G 1/2)

50-486
(G 3/4)

70-34
(G 5/6)

50-488
(G 7/8)

50-489
(G 9/10)

50-490
(G 11/12)

50-491
(G 13/14)

Curettes



COLUMBIA

McCALLS



50-492
(CO 4L/4R)

50-493
(CO 13/14)

50-494
(CO 2L/2R)

50-495
(MC 13/14)

50-496
(MC13S/14S)

50-497
(MC 17/18)

50-498
(MC 17S/18S)

Curettes



GOLDMAN-FOX

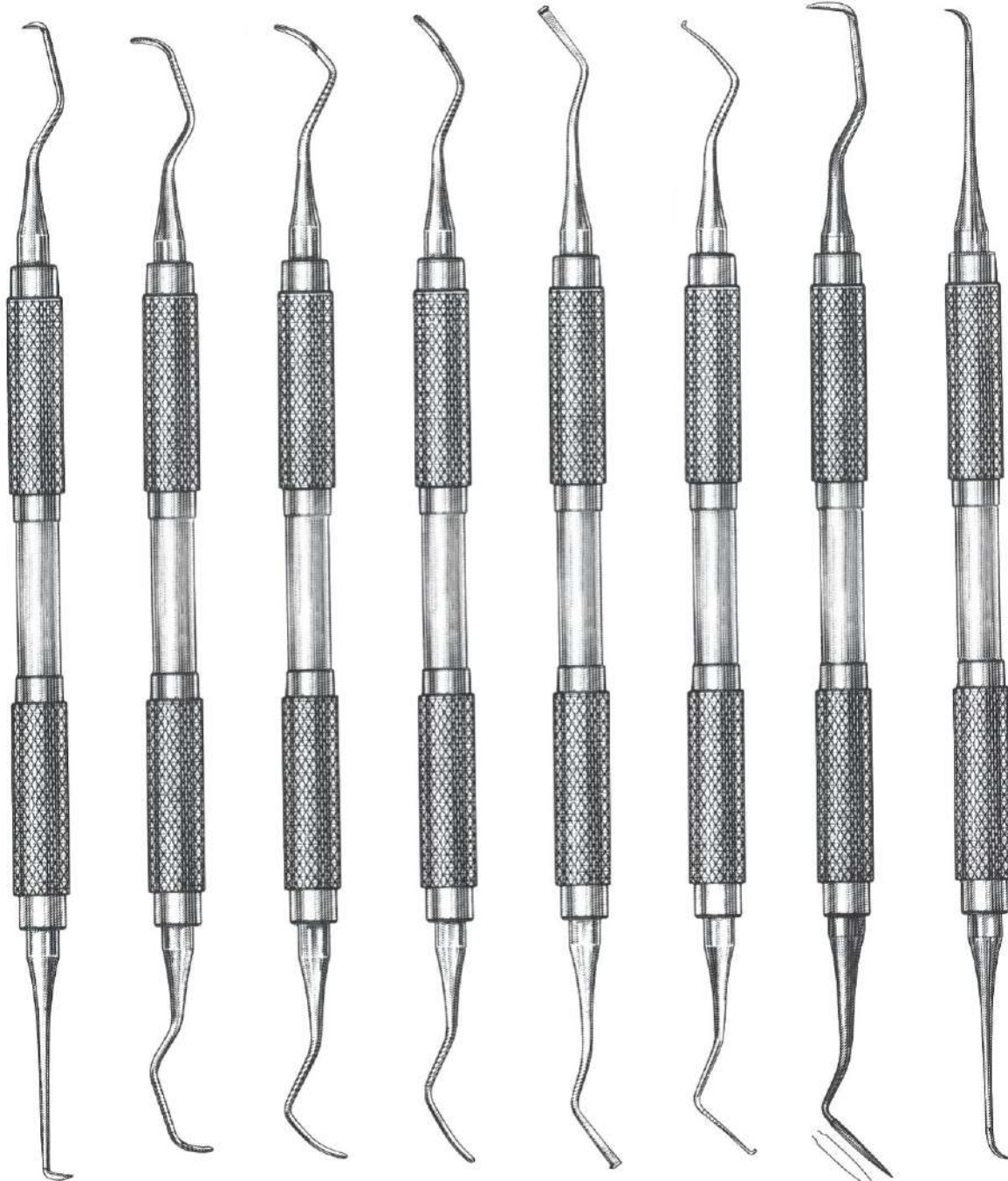

50-499
Universal
Scaler
(GF 1)

50-500
Curette-
Anterior
and Premolar
(GF 2)

50-501
Curette-
Posterior
(GF 3)

50-502
Curette-
Molar
(GF 4)

50-503
Scalar
(GF 5)

50-504
Scalar
(GF 6)

50-505
Knife/Scaler
(GF 9)

50-506
Curette
(GF 12)

Scalers



JACQUETTE



50-507
(U-15)



50-508
(JAC 1Y/1Y)



50-509
(JAC 1Y/1YS)



50-510
(JAC 2Y/3Y)



50-511
(JAC 2YS/3YS)

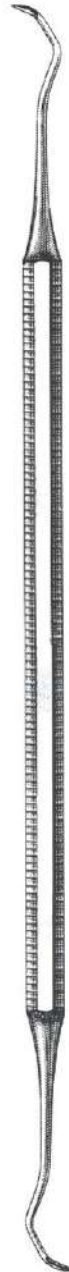

50-512
(JAC 2/3)



50-513
(JAC 2S/3S)



50-514
(JAC 1)

Scalers



50-515
#3



50-516
#12



50-517
#204S



50-518
Younger
7/8



50-519
Whiteside
1-0

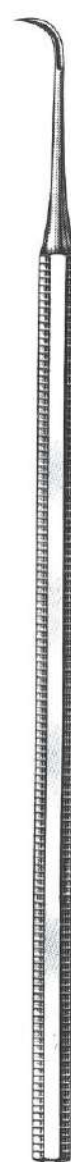

50-520
Whiteside
2-0

Scalers



50-521
(U15/30)



50-522
(U15/33)



50-523
(H 5/33)



50-524
(H 6/7)



50-525
(TA 2/3)

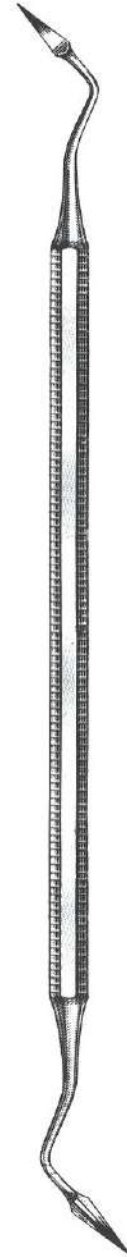

50-526
(CK 6)



GOLDMAN-FOX

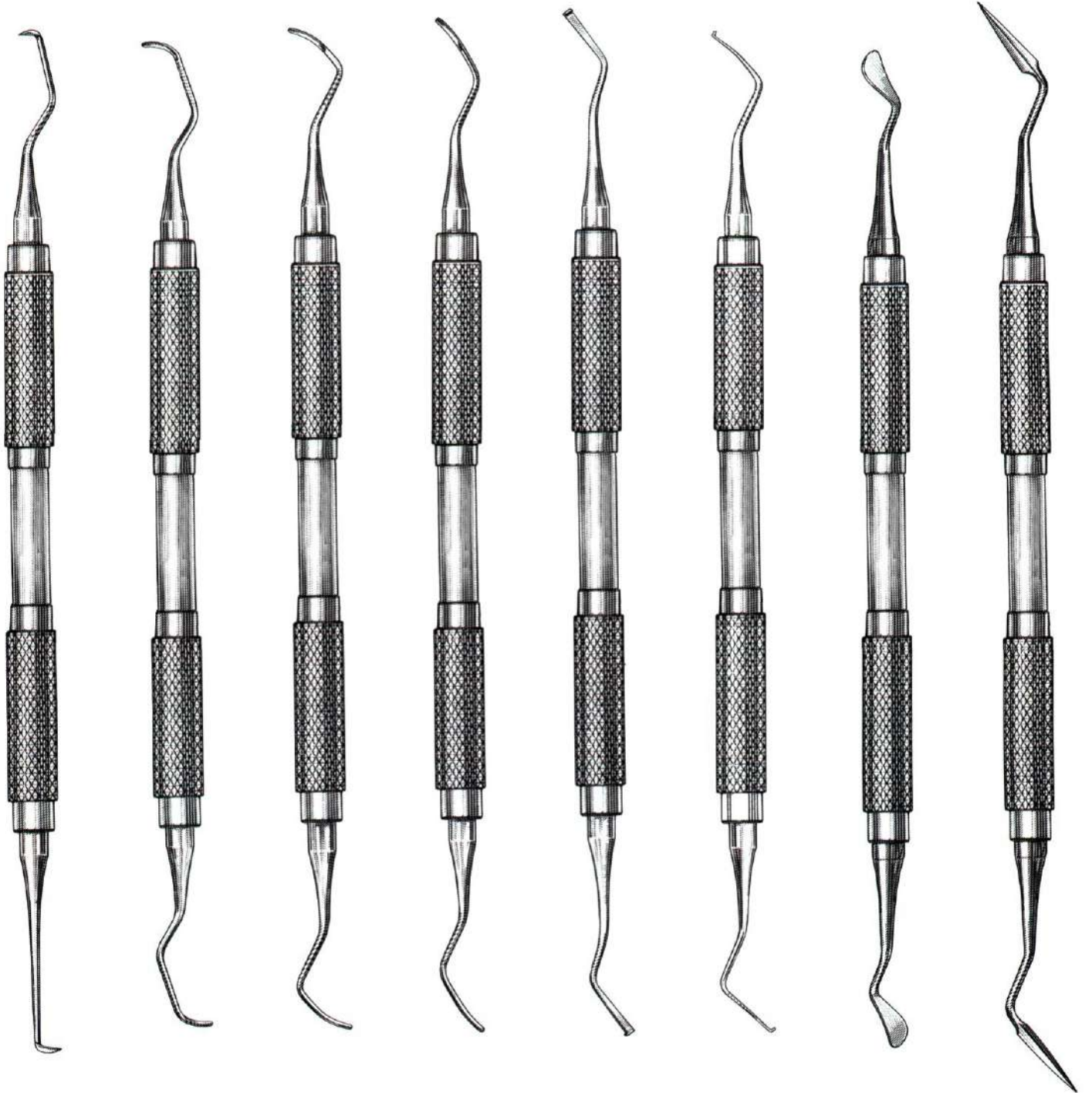

50-527
Universal
Scaler

50-528
Curette-
Anterior
and Premolar

50-529
Curette-
Posterior

50-530
Curette-
Molar

50-531
Scaler

50-532
Scaler

50-533
Knife

50-534
Spear
Knife



GOLDMAN-FOX



50-535
Knife/Scaler



50-536
Tissue Retractor

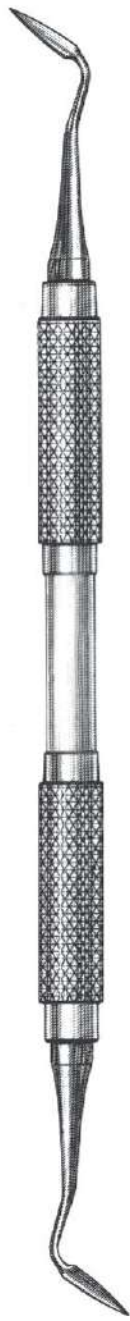

50-537
Spear
Knife



50-538
Curette



50-539
Periosteal
Elevator



50-540
OCHSENBEIN
Chisel 1

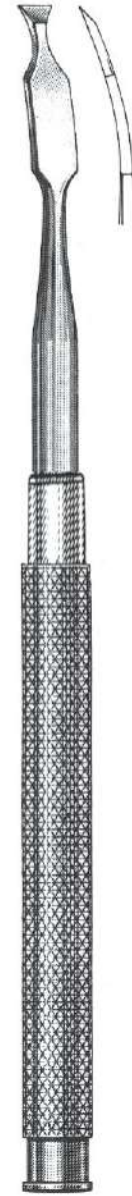

50-541
OCHSENBEIN
Chisel 2



50-542
OCHSENBEIN
Chisel 4



CRANE-KAPLAN



50-543
ORBAN
Knife 1-2

50-544
Ck1
Pocket
Marker

50-545
Ck2
Pocket
Marker

50-546
Knife

50-547
Dissector

50-548
Dissector

50-549
Scaler

50-550
File

50-551
File

Periodontal



1/2



50-552
Tissue Nipper, 5"



50-553
Tissue Nipper, 4"



50-554
Blade Breaker, 4 1/2"



50-555
Blade Breaker, 5 1/4"



50-556
Ross
Self Locking
Tissue Forceps, 6 1/4"



50-557
Ross Perio
Needle Holder, 5 1/2"



50-558
Ross Perio
Scissors, 4 3/4"



50-559
CASTROVIEJO
Perio Scissors, 3 1/2"

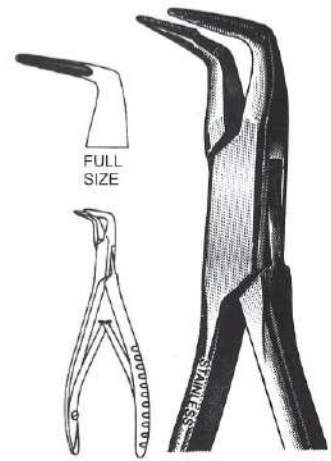

50-560
MICRO-FRIEDMEN
Perio Rongeur, 5 1/2"

Periodontal

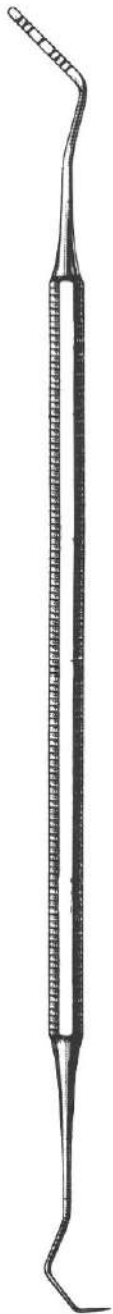

50-561
Probe/Explorer
(GF 17)



50-562
Probe
(GF 18)

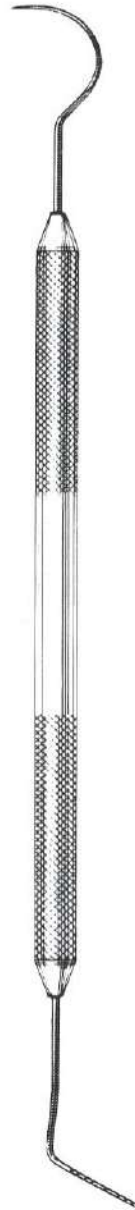

50-563
Probe/Explorer
(PE 1-23)



50-564
Probe
(C)



50-565
Probe
(X2)

Plastic Filling Instruments



50-566
(PF 3)

50-567
(PF 4)

50-568
(PF 5)

50-569
(LAD 3)

50-570
(WDS 1)

50-571
(WDS 2)

50-572
(WDS 3)

50-573
(PF W3)

50-574
(PF G 4/5)

Burnishers, Amalgam Pluggers



AMALGAM PLUGGERS

BURNISHERS

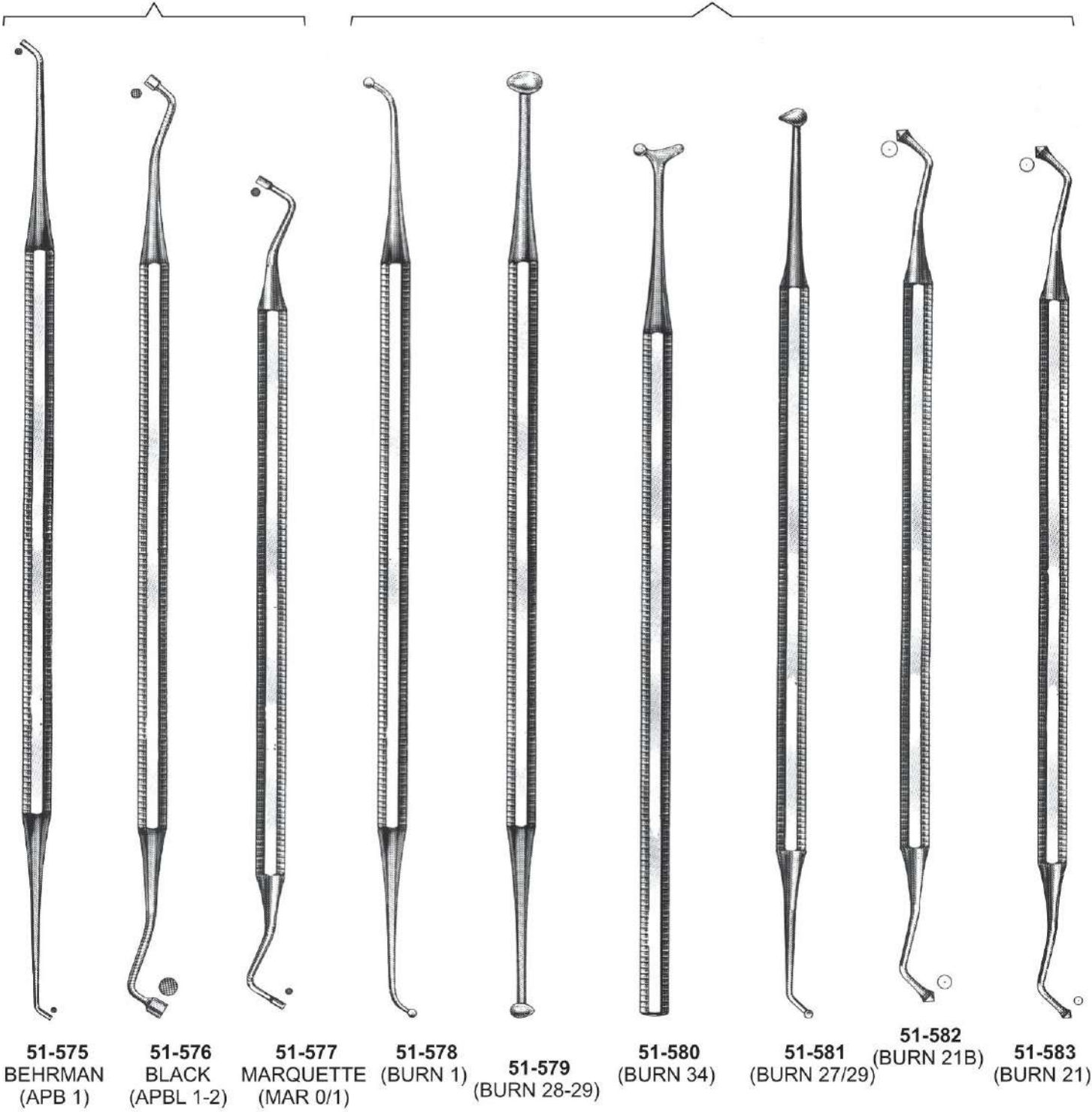

51-575
BEHRMAN
(APB 1)

51-576
BLACK
(APBL 1-2)

51-577
MARQUETTE
(MAR 0/1)

51-578
(BURN 1)

51-579
(BURN 28-29)

51-580
(BURN 34)

51-581
(BURN 27/29)

51-582
(BURN 21B)

51-583
(BURN 21)

Amalgam Carriers



SIZE 1/2

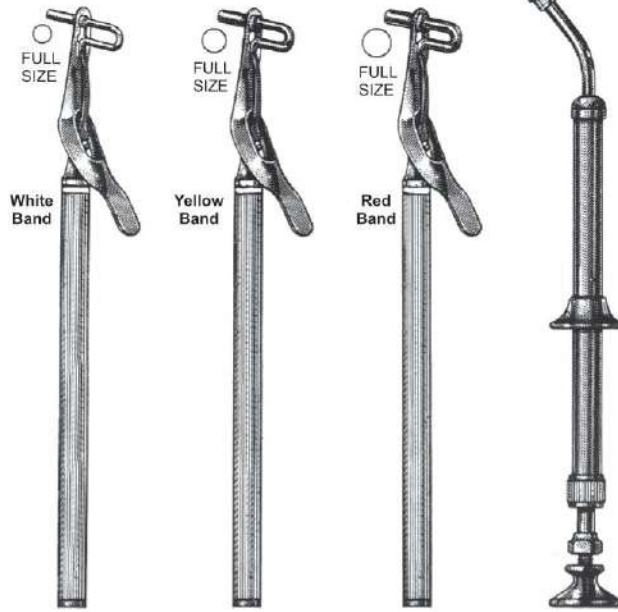

MEDIUM
52-586

LARGE
52-588

JUMBO
52-590

52-592
NYLON TIP
and Plunger

STAINLESS BARRELS
DELTRIN BARRELS

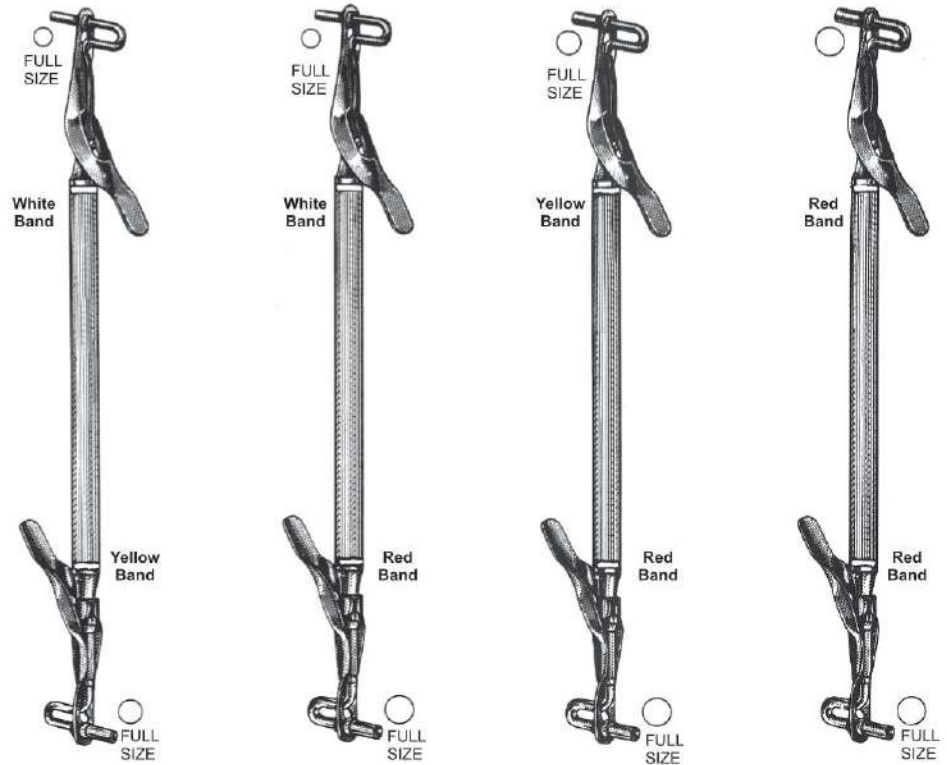

MEDIUM/LARGE
52-593

MEDIUM/JUMBO
52-595

LARGE/JUMBO
52-597

JUMBO/JUMBO
52-599

STAINLESS BARRELS
DELTRIN BARRELS

Crown Gripper, Crown Remover



51-584
WYNMAN CROWN GRI
T-CARBIDE JAWS



51-585A



1- 51-586B



51-587C

51-585 MORREL Crown
Remover Complete with A, B and C
3 points- A, B and C
51-585A Point A only
51-585B Point B only
51-585C Point C only

Matrix Retainers and Bands, Strip Holder C



53-602
#1

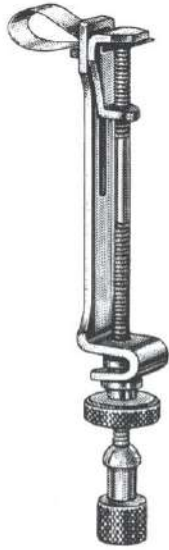

53-603
#8



53-604
#9



53-605
JUNIOR

"TOFFLEMIRE" TYPE



53-606
SENIOR



53-607
UNIVERSAL

TOFFLEMIRE BAN



.0015" **53-608**
.002" **53-609**



.0015" **53-610**
.002" **53-611**

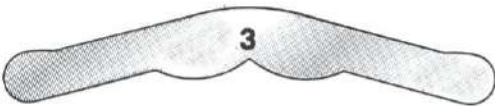

.0015" **53-612**
.002" **53-613**

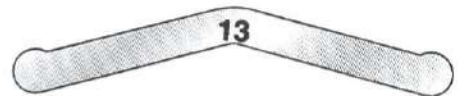

.0015" **53-614**
.002" **53-615**



53-616
Strip Holder
Clip, 90°



53-617
Strip Holder
Clip, 45°



**COMFORT GRIP
VINYL-COVERED INSULATING
HANDLES**



54-618 ROACH-A 54-619 ROACH-B 54-620 LECRON 5-A 54-621 LECRON 5-B 54-622 VEHE-A 54-623 VEHE-B 54-624 A7 54-625 B7 54-626 WARD 2-A 54-627 WARD 2-B

54-618S Set of 10 Comfort Grip Instruments

Wax Instruments



P. K. THOMAS



54-628

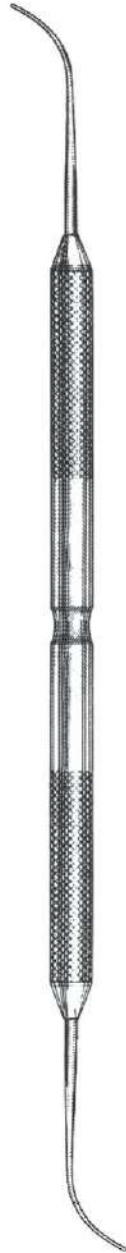

54-629



54-630



54-631



54-632

54-628S Set of 5 Instruments

Wax Carvers



54-633
HOLLENBACK
3



54-634
HOLLENBACK
3S



54-635
WARD
1



54-636
WARD



54-637
WALL
1



54-638
WALL
3

Wax and Porcelain Carvers



54-639
LECRON
Inlay



54-640
REEVES



54-641
ROACH
WAX

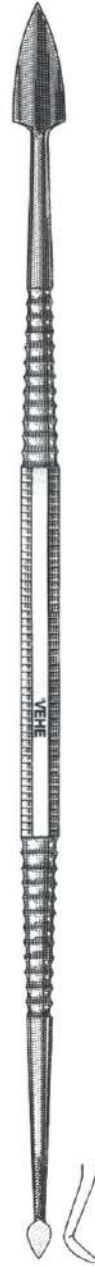

54-642
VEHE
Wax



54-643
FAHNENSTOCK 5"
54-644
FAHNENSTOCK 6 3/4"

Wax Spatulas



54-645



54-646



54-647



54-648
Small end
with one flat
side



54-649

Cement Spatulas



54-650



54-651
Flexible

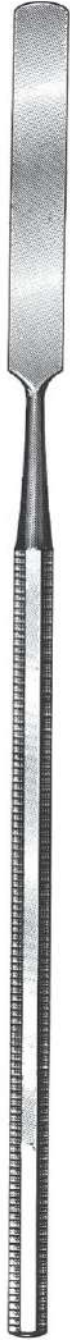

54-652
Rigid



54-653



54-654



54-655



54-656
AGATHE

Miscellaneous Laboratory Instruments



Platinum Foil Holding Forceps (All shown full size)

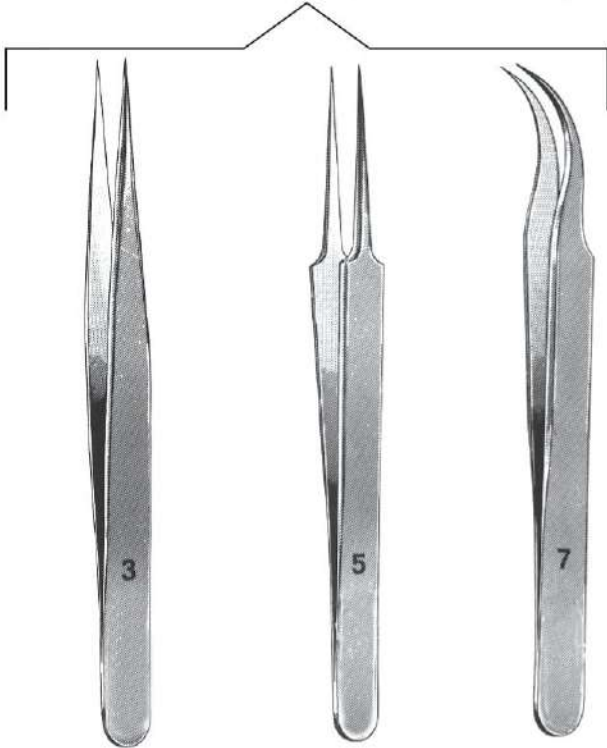

55-657
Narrow, Fine,
4 3/4"

55-658
Super Fine
4 3/8"

55-659
Fine Curved
4 1/2"

1/2



55-660
ALL-PURPOSE Scissors
7 1/2"



55-665
Furnace Tongs, 10"
55-666
Furnace Tongs, 12"



55-661
MURPHY
Plaster Knife



55-662
Plaster and
Compound Knife



55-663
Soldering Tweezers,
6 1/4"



55-664
Plaster Nipper 8" Stainless
with Plastic Covered Handles

Instruments shown 1/2 size except where indicated otherwise

Pliers

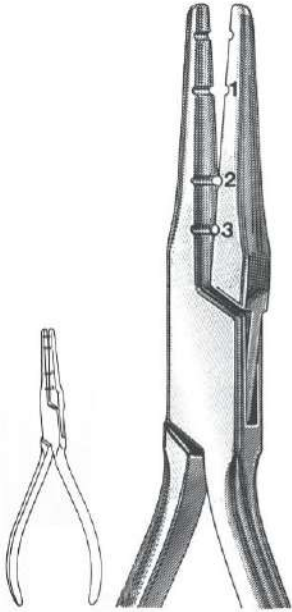

56-667
101-Wire Bending

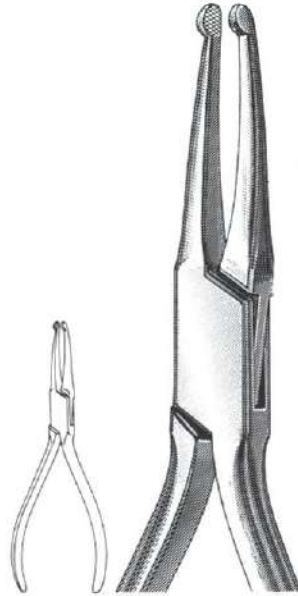

56-668
110-HOW Crown, Str.

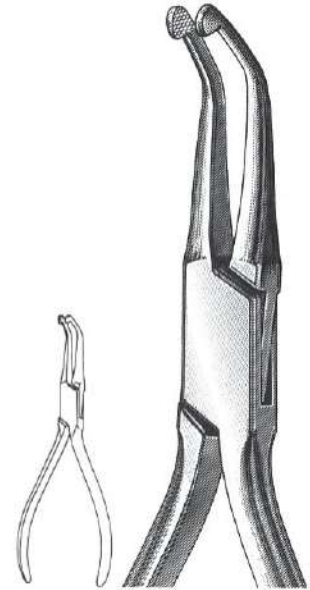

56-669
111-HOW Crown, Curved

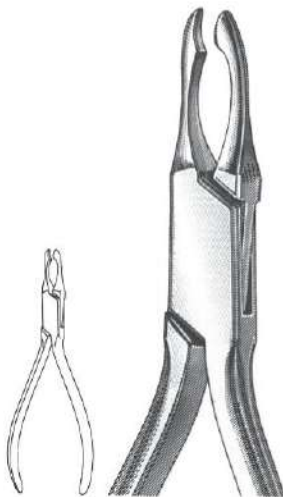

56-670
114-JOHNSON, Contouring

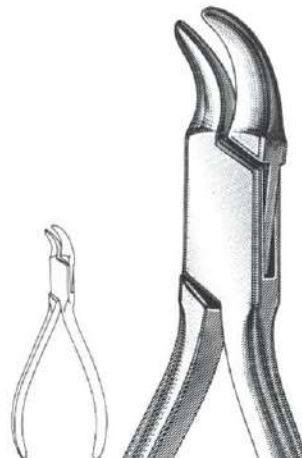

56-671
115-REYNOLDS, Contouring

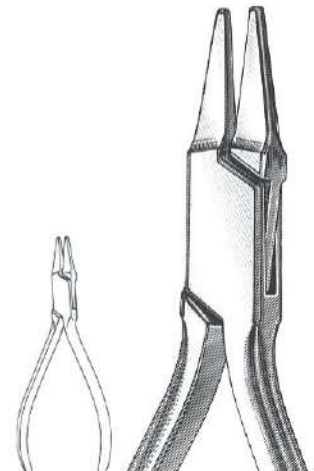

56-672
118-PEESO, Collar

Pliers

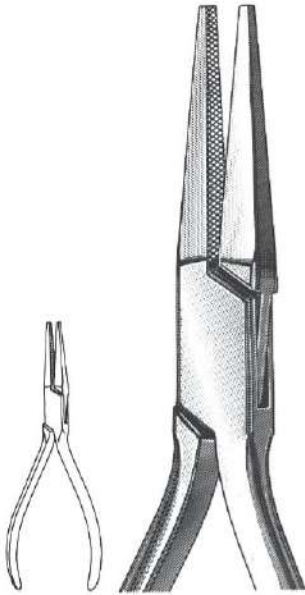

56-673
121-LAB and Office

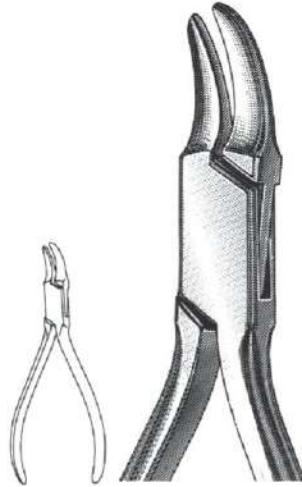

56-674
137-GORDON, Contouring

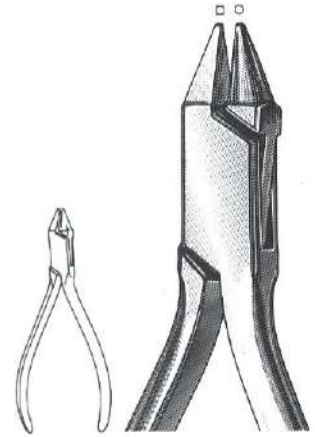

56-675
139-Angle Wire Bending

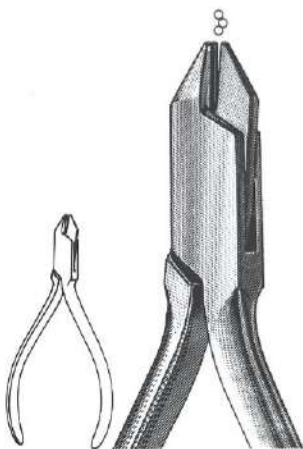

56-676
200-Clasp Adjusting

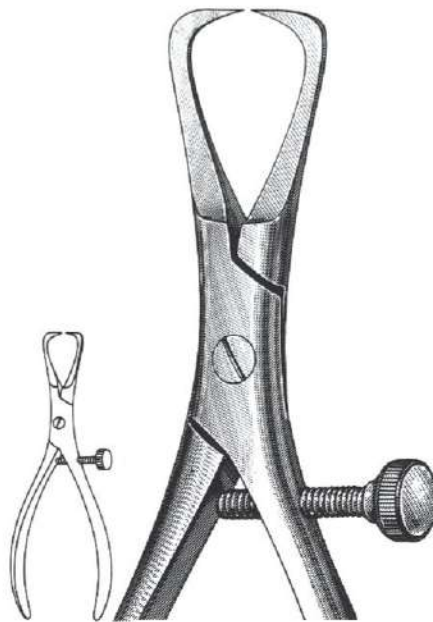

56-677
255-BAADE, Band and Shell
Removing

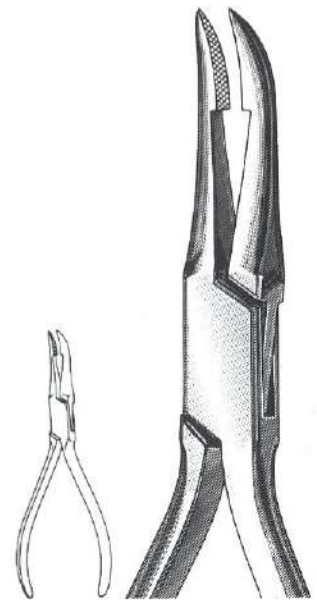

56-678
861-WEINGART, Utility

Pliers

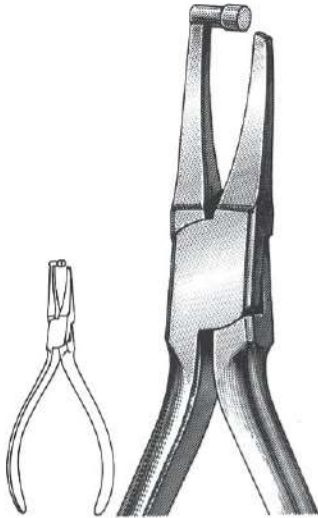

56-679
347-OLIVER, Band Removing,
Aluminum Tip

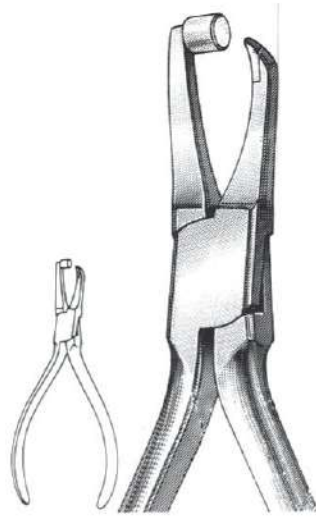

56-680
347NTS-Nylon tip, Tool,
Steel Insert Jaw

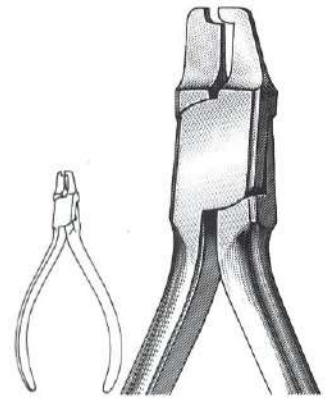

56-681
417-Crown and Shell

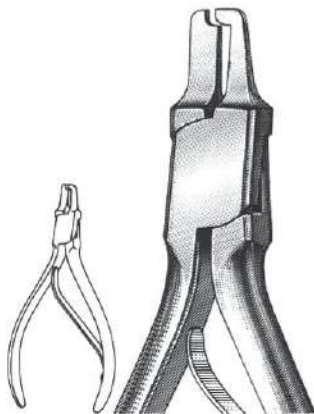

56-682
421S-Primary Crown Crimping

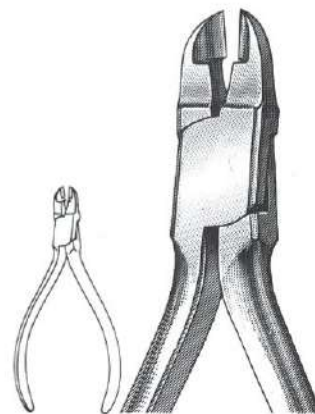

56-683
150S-Carbide Tipped
Ligature Cutter

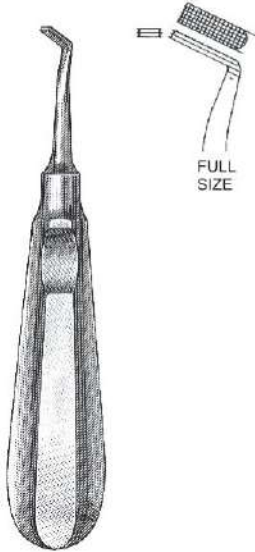

57-687
300X-One Piece
Construction Band
Pusher



57-688
Wire Twister 6", with T-Carbide
Jaws
57-689
Wire Twister 8", with T-Carbide
Jaws

Endo Forceps



1/2



57-694
STIEGLITZ
Fragment Forceps,
4 3/4", 90°

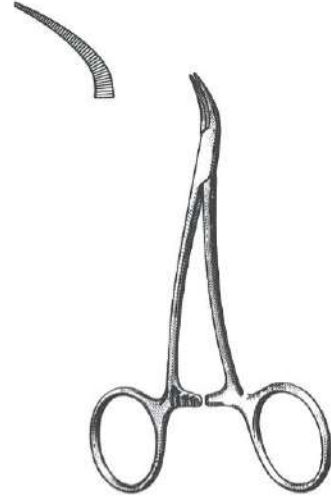

66-696
PEETS Forceps, 4 3/4",
useful for removing
broken instruments



66-695
Silver Point
Holding Forceps, 4 3/4"

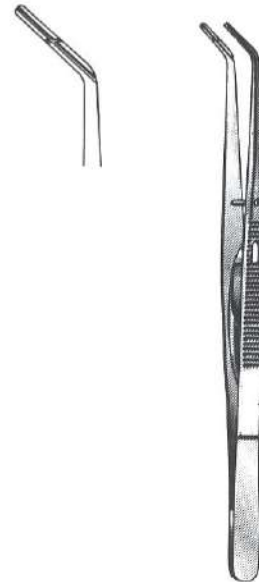

66-697
Self-locking
Silver Point
Holding Forceps, 6"

Instruments shown 1/2 size

Articulating Paper Forceps, Rubbers Dam Punches

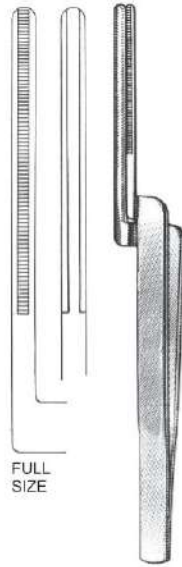

58-698
POSIGRIP Articulating
Papers Forceps

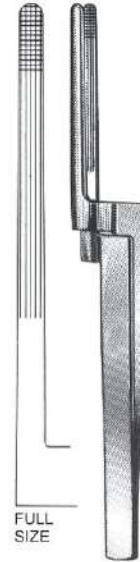

58-699
Standard Articulating
Paper Forceps, Economy Grade



58-700
AINSWORTH Type Rubber
Dam Punch



58-701
Lightweight Rubber
Dam Punch

Instruments shown 1/2 size

Rubber Dam Clamp Forceps and Holder

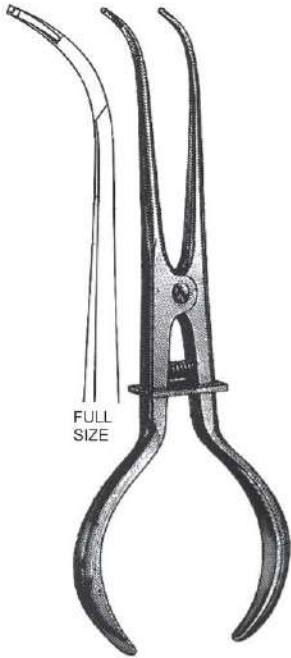

58-702
U. Of Washington Pattern.
Rubber Dam Clamp Forceps

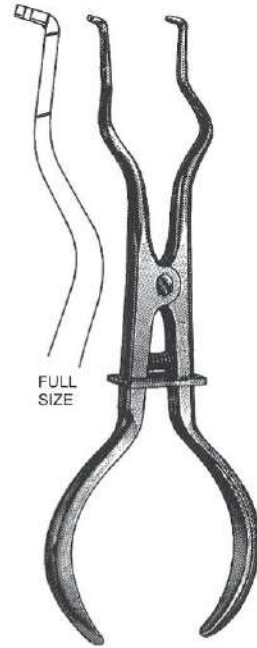

58-703
Brewer Rubber
Dam Clamp Forceps

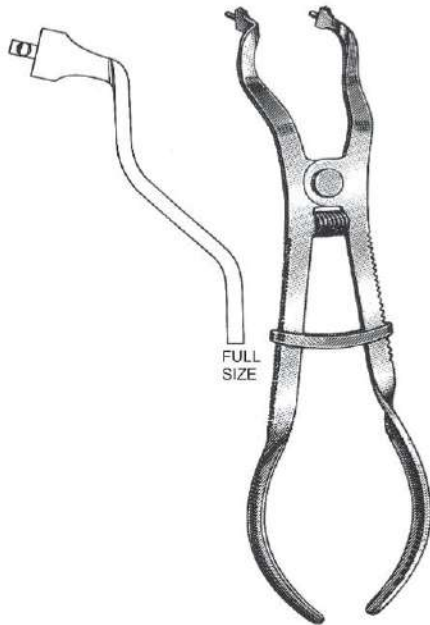

58-704
Lightweight Rubber
Dam Clamp Forceps

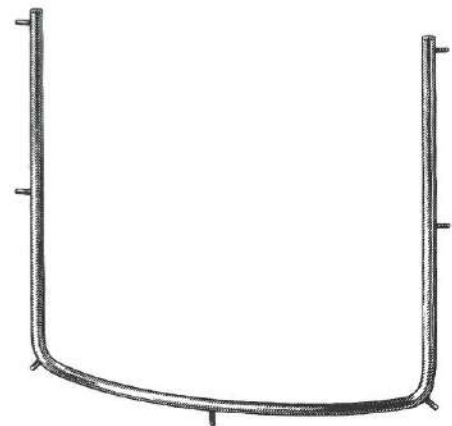

58-705
Rubber Dam Holder,
Stainless Pins

Instruments shown 1/2 size

Scalpel Handles



59-706
59-706A



59-707



59-708



59-709



59-710



59-711
SIEGEL

59-706

KNIFE HANDLE No. 3 fitting surgical blades Nos. 10 thru 15, Extra Fine Stainless

59-706A

Same as No. 4-7, but Economy Grade, Rustless, Nickle Plated

59-707

KNIFE HANDLE No. 7, fitting surgical blades Nos. 10 thru 15, Extra fine Stainless

59-708

KNIFE HANDLE No. 3L, for deep surgery, fitting blades Nos. 10 thru Extra Fine, Stainless

59-709

KNIFE HANDLE No. 3LA, angled tip, for deep surgery, fitting blades 10 thru 15, Extra Fine, Stainless

59-710

Knife Handle No.9, fitting blades No.10 thru 15 Extra fine stainless

59-711

SIEGEL ROUND KNIFE HANDLE, fitting blades Nos. 10 thru 15, Extra Stainless

Scalpel Handles



59-712
59-712A



59-713



59-714
59-714A



59-715



59-716



59-717

59-712

KNIFE HANDLE No. 5 fitting surgical blades Nos. 10 thru 15, Extra Fine, Plastic

59-713

E-Z OFF (Pat. Pend.) KNIFE HANDLE No. 3, fitting surgical blades Nos. 10 thru Autoclavable, Plastic

59-714

KNIFE HANDLE No. 4 Fitting surgical blades 20 through 25, Extra fine stainless

59-714A

Same as No. 59-714, but Economy Grade, Rustless, Nickle Plate, has mm and cm graduations

59-715

KNIFE HANDLE No. 4L, for deep surgery, fitting blades Nos. 20 thru 25, Extra Fine, Stainless

59-716

KNIFE HANDLE No. 6 fitting surgical blades Nos. 20 thru 25, Extra Fine, Red Plastic

59-717 knife handle No.4, fitting blades Nos.20 thru 25 Autoclavable, plastic.

Mucocele Forceps Suction Tubes

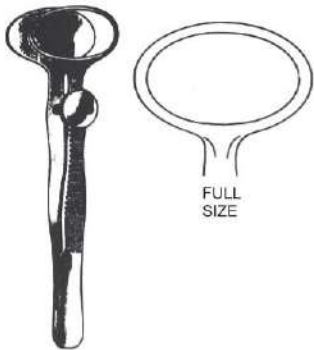

59-718
MUCOCELE FORCEPS
Fixate, isolate and act as a haemostat, allowing a clear field, thus facilitating surgery. Iride ring measures 12x23 mm

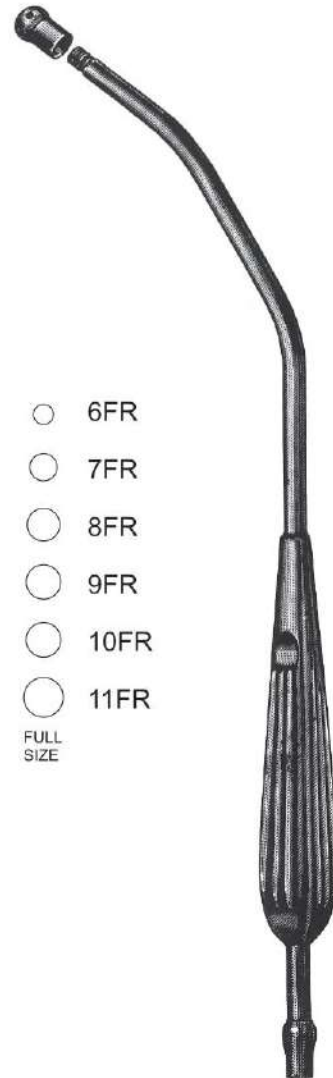

59-719
YANKAUER
SUCTION TUBE
11 3/4"
59-720
CHROME
Stainless

Syringes, Spatulas, Holders



PLASTER SPETULAS



14 R
59-721



11 R
59-722



10 R
59-723



8 R
59-724



3 R
59-725

ASPIRATING SYRINGES



Aspirating Syringe
Type M
59-726-M



Aspirating Syringe
Type CW
59-726



61-732
Fig. 1
Frahm



60-727
Napkin Holder
with Metal Chain

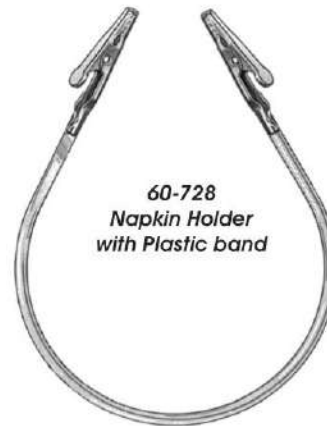

60-728
Napkin Holder
with Plastic band



62-733
Alcohol Lamp
with Lid



60-729
Film Holder for 10 Films
60-730
Film Holder for 6 Films
60-731
Film Holder for 14 Films

Alphabetical Index

A

Adson Dressing Forcep	46
Adson Tissue Forcep	45
Agatha Cement Spatula	85
All-purpose Scissors	86
Allis Tissue Forceps	45
Amalgam Carriers	77
Amalgam Pluggers	76
Amalgam Well	77
Andrew Tongue Depressor	35
Angle Wire Bending Pliers	88
Articulating Paper Forceps	94

B

Backhaus Towel Clump	48
Band Bushers	91
Bandage Scissor	41
Baumgartner Needle Holder	52
Behrman Amalgam Pluggers	76
Beyer Rongeur	27
Black Amalgam Plugger	76
Blade Breakers	73
Blumenthal Rongeurs	24
Boley Gauge	59
Bone Chisels	31
Bone Curetters	28
Bone Files	29
Bone Holding Forceps	33
Bone Mallets	32
Bone Rongeur	27
Boynton Needle Holder	51
Brown Tissue Forceps	45
Buckley Bone Chisel	31
Burnishers	76

C

Castroviejo Gum Scissors	41,73
Castroviejo Needle Holders	54
Cement Spatulas	85
Cheek Retractors	34
Chisels, Bone	31
Chisels, Periodontal	71
Clamps, Towel	48
Clasp Adjusting Plier	88
Clips, Strip Holder	79
Collar & Crown Scissors	44
College Pliers	57
Collier Needle Holder	50
Columbia Curettes	65
Columbia Lip Retractor	34
Compound Knife	86
Cotton And Dressing Pliers	57
Crane-kaplan Perio Instruments	72
Crile-wood Needle Holder	52-53
Crile Needle Holders	53

Crown & Shell Crimping Pliers	89
Crown Gauge	59
Crown Gripper	78
Crown Remover	78
Curettes	64-66
Curettes, Bone	28

D

Davis Sterilizer Forceps	56
Dean Gum Scissors	37
Dehardt Mouth Gag	36
Depressors, Tongue	35
Deft Needle Holders	50
Dingman Bone Holding Forceps	33
Dividers	59
Dressing Forceps	46

E

Elevators	20-23
Endo Forceps	93
Endo Instruments	92
Endo Sterilizer Cases	92
English Pattern Extracting Forceps	16
Excavators	63
Explorer-probes	62
Explorers	60-61
Extracting Forceps	5-19

F

Fahnenstock Wax Carver And Knife	83
Fiberglass Mirrors	58
Files, Bone	29
Files, Periodontal	72
Forceps, Articulating Paper	94
Forceps, Bone Holding	33
Forceps, Dressing	46
Forceps, Endo	93
Forceps, Extracting	5-19
Forceps, Hemostatic	49
Forceps, Mucocoele	98
Forceps, Platinum Foil Holding	86
Forceps, Root	14
Forceps, Rubber Dam Clamp	95
Forceps, Silver Point Holding	57,93
Forceps, Sterilizer	56
Forceps, Tissue	45
Forceps, Tongue Seizing	35
Frazier Tissue Hooks	47
Freer, Periosteal Elevator	23,71
Friedman Rongeurs	26
Furnace Tongs	46,86

G

G-F Curettes	66
G-F Periodontal Instruments	37-70-71
G-F Gum Scissors	37
Gardner Bone Chisels	31
Gardner Needle Holder	51
Gauges	59

Gerzog Mallet	32
Gordon Contouring Plier	88
Gracey Curettes	64
Gregg Plastic Filling Instruments	75
Gum Scissors	37-41

H

Halsey Needle Holders	50
Halstead Mosq. Forceps	49
Handles, Mirror	58
Handles, Scalpel	94-95
Hartman Rongeur	27
Heath Gum Scissors	37
Hemostatic Forceps	49
Holdes, Needle	50-54
Hollenback Wax Carvers	82
Hooks, Tissues	47
How Crown Pliers	87
Howard Bone File	30

I

Impression Trays	55-56
Inlay Carver	83
Instruments, Orthodontic	91
Iris Gum Scissors	38-39

J

Jacquette Scalars	67
Johnson Contouring Pliers	87
Jones Towel Clamp	48
Joseph Gum Scissors	40

K

Kelly Forceps	49
Kelly Gum Scissors	40
Kern Bone Holding Forceps	33
Knife, Compound	86
Knife, Orban Perio	72
Knives, Plaster	86
Knowles Bandage Scissors	41

L

La Grange Gum Scissors	40
Ladmore Plastic Filling Instruments	75
LeCrony Inlay Carvers	80-83
Ligature Cutting Pliers	89
Lip Retractors	34
Lister Bandage Scissors	41
Littauer Suture Scissors	43
Locklin Gum Scissors	41
Long Suture Scissors	43
Lorna Towel Clamps	48
Lucas Bone Cerettes	28

M

Mallets, Bone	32
Marquette Amalgam Plugger	76
Mathieu Needle Holders	51
Matrix Bands	79

Matrix Retainers	79
Matrix Scissors	44
Mayo-Hegar Needle Holders	52
Mayo Scissors	42
McCalls Curettes	65
Mead Bone Mallet	32
Mead Extracting Forceps	15
Mead Rongeurs	25
Meria Plier	57
Miller Bone Files	29
NS Bone Mallets	32
NS Lip Retractor	34
NS Tissue Fixator	47
Mirror Handles	58
Mirrors, Mouth	58
Molt Bone Curettes	28
Molt Mouth Gags	36
Molt Periosteal Elevator	23
Morrel Crown Remover	78
Mouth Gags	36
Mouth Mirrors	58
Mococele Forceps	98

N

Napkin Holders	48
Needle Holder, Periodontal	73
Needle Holders	50-54
Neivert Needle Holder	50
Nipper, Plaster	86
Northbent Suture Scissors	43

O

Ochsenbein Pero Chisels	71
Oliver Band Removing Pliers	93
Olsen-Hegar Needle Holders	51
Orban Perio Knife	72
Orthodontic Instruments	91
Orthodontic Wire	91

P

P. K. Thomas Wax Instruments	81
Pedodontic Extracting Forceps	18-19
Peeso Collar Pliers	87
Peets Forceps	14-93
Periodontal Files	72
Periodontal Instruments	70-74
Periodontal Rongeur	73
Periosteal Elevators	23-71
Perry Pliers	57
Plaster Knives	86
Plaster Nipper	86
Plastic Filling Instruments	75
Pliers	87-89
Pliers, Cotton And Dressing	57
Pocket Markers, Perio	72
Polokoff Bone File	30
Porcelain Carvers	83
Potts Periosteal Elevators	23
Probes	62
Probes, Periodontal	62-74
Probes, Salivary Gland	98

Q

Quimby Gum Scissor 37

R

Reeves Wax Carver 83
Retraction Cord Cutting Scissors 43
Retractors, Cheek 34
Retractors, Tissue 47
Reynold Contouring Plier 87
Roach Wax Carvers 80,83
Rongeur, Periodontal 73
Rongeurs 24-27
Ross Gum Scissor 41-73
Ross Periodontal Instruments 73
Rubber Dam Clamp Forceps 95
Rubber Dam Holder 95
Rubber Dam Punches 94
Russian Tissue Forceps 45
Ryder Needle Holders 53

S

Selivary Gland Probes 98
Scalers 67-69
Scalpel Handles 94-95
Scissors, All-purpose 86
Scissors, Bandage 41
Scissors, Collar & Crown 44
Scissors, Gum 37-46
Scissors, Periodontal 37-41-73
Scissors, Retraction Cord 43
Scissors, Surgical 42
Scissors, Suture 43
Scissors, Wire Cutting 44
Seldin Periosteal Elevator 23
Self-locking Pliers 57,93
Semkin Dressing Forcep 46
Semkin Tissue Forceps 45
Senn Tissue Retractor 47
Shortbent Suture Scissors 43
Silver Point Holding Forceps 57-93
Soldering Tweezers 86
Spatulas, Cement 85
Spatulas, Wax 84
Spencer Suturere Scissors 43
Splinter Forceps 14,93
Stevens Needle Holder 54
Stieglitz Forceps 14-93
Strip Holder Clips 79
Suction Tubes 98
Sullivan Gum Scissors 40
Surgical Scissors 42
Suture Scissors 43
Suture Wire 91

T

Taylor Scaler 69
Tissue Forceps 45-73
Tissue Forceps, Periodontal 47-73
Tissue Hooks 47
Tissue Nippers 73
Tissue Retractors 47
Tofflemire Type Band 79
Tofflemire Type Retaines 79
Tongue Depressors 35
Tongue Seizing Forceps 35
Towel Clamps 53
Tweezers, Soldering 86

U

U Of Minnesota Cheek Retractor 34
Utility Sterilizer Forceps 56

V

Vehe Wax Carvers 80,83

W

Wagner Gum Scissors 39
Wakefield Bone Chisels 31
Wall Wax Carvers 82
Ward Wax Carvers 80,82
Wax Instruments 80-83
Wax Spatulas 84
Wabster Tongue Depressor 50,53
Weingart Utility Pliers 88
Wast Periosteal Elevator 23
Whiteside Scaler 68
Wieder Tongue Depressor 35
Wire Bending Pliers 87
Wire Cutters 90
Wire Cutting Scissors 44
Wire Twisters 91
Witzel Root Forceps 14
Woodson Plastic Filling Instruments 75
Wynman Crown Gripper 78

Y

Yankauer Suction Tubes 98
Young Tongue Seizing Forceps 35
Younger Scaler 68

Welcome to TRS Instruments a leading manufacturer of cutting-edge dental instruments dedicated to elevating oral healthcare standards worldwide. Our meticulously crafted instruments are designed to empower dental professionals with precision and innovation. From diagnostic tools enabling accurate assessments to surgical instruments facilitating complex procedures, our comprehensive range covers all aspects of modern dentistry. With a commitment to quality, our instruments are engineered from premium materials, ensuring durability and patient safety. At TRS Instruments, we take pride in contributing to the success of dental practices by providing reliable tools that meet the evolving demands of the industry. Discover excellence in dental instrumentation with TRS Instruments.



Info@trsstruments.com



+92-301-9643745



+92-523305268



1, Bhinder, Tasleem Pura, Sialkot Pakistan