

TRS
INSTRUMENTS



CATALOG

TRAUMATOLOGY ORTHOPAEDICS

1	Retractors Retraktoren Écarteurs Separadores Divaricatori					
27	Elevators Elevatoren Élévateurs Elevadores Elevatori	Periosteal (Raspatories) Raspatorien Rugines périostiques Periostótomos (Legras) Scollaperiosteo (Periostotomi)	Bone files Knochenfeilen Limes à os Limas para hueso Lime per osso	Sharp Curettes Scharfe Küretten Curettes tranchantes Curetas cortantes Curette taglienti		
63	Surgical Mallets Chirurgische Hämmer Maillets chirurgicaux Martillos quirúrgicos Martelli chirurgici	Tampers Stößels Compacteurs Compactadores Compattatori	Osteotomes Osteotome Ostéotomes Osteótomos Osteotomi	Chisels Meißeln Burins Cinceles ScalPELLi		
87	Bone surgery Knochenchirurgie Chirurgie osseuse Cirugía ósea Chirurgia ossea	Bone Holding Forceps Knochenhaltezange Daviers à os Pinzas de sujeción Pinze per fissare l'osso	Hand Surgery Handchirurgie Chirurgie de la main Cirugía de la mano Chirurgia della mano	Bone Rongeurs Hohlmeißelzangen Pincés gouges Pinzas gubias Pinze ossivore	Bone Cutting Scissors Knochensplitterscheren Ciseaux à os Tijeras para huesos Forbici ossivore	
115	Wires and Nails Bohrdrähte Broches et clous Agujas y clavos Fili e chiodi	Extension Bows Extensionsbügel Étriers d'extension Arcos de tracción Archi da trazione	Twist Drills Spiralbohrer Forets Brocas espirales Maschiatori - Taps	Osteosintese Osteosynthesis Ostéosynthèse Osteosintesis Osteosintesi	Hand Drills Handbohrapparate Perceuses à main Perforadores manuales Perforatori a mano	Screwdrivers Schraubendreher Tournevis Destornilladores Cacciaviti
143	Measuring Instruments Messinstrumente Instruments à mesurer Instrumentos de medición Strumenti per misura					
149	Forceps for plattes Biege und schränkhebel Pincés à courber pour plaques Pinzas para placas Pinze e chiavi per placche	Wire Guides Drahtumföhrungsnadel Aiguilles passe-fils Agujas pasa hilos Passafili	Needle Holders Nadelhalter Porte-aiguilles Porta-agujas Port'aghi	Cutting Pliers Schneidezangen Pincés coupante Alicates de corte Tronchesi di taglio		
169	Retractors Retraktoren Écarteurs Separadores Divaricatori	Nervhaken Nerve Hooks Crochets à nerfs Ganchos para nervios Uncini per nervi	Micro Dissectors Mikro-Dissektoren Micro Dissecteurs Micro Disecadores Micro Dissettori			
189	Suction Tubes Saugkanülen Canules d'aspiration Cánulas de aspiración Cannule per aspirazione	Laminectomy Laminektomie Laminectomia Laminectomia Laminectomia	Extension Bows Extensionsbügel Étriers d'extension Arcos de tracción Archi da trazione	Knives Messer Couteaux Cuchillos Coltelli	Bone files Knochenfeilen Limes à os Limas para hueso Lime per osso	Scalpels Skalpelle Bistouris Bisturías Bisturi
207	Towel Clamps Tuchklemmen Pince fixe-compresses Pinzas de campo Fissateli	Scissors Scheren Ciseaux Tijeras Forbici	Tissue Forceps Chirurgische Pinzetten Pincés à tissus Pinzas quirúrgicas Pinzette chirurgiche	Needle Holders Nadelhalter Porte-aiguilles Porta-agujas Port'aghi	Hemostatic Forceps Arterienklemmen Pincés hémostatiques Pinzas hemostáticas Pinzette emostatiche	
221	Alphanumerical Index Alphanumerischen Index Index alphanumérique Indice alfanumérico Indice alfanumerico					

Wundhaken

Retractors

Divaricatori

Separadores

Écarteurs

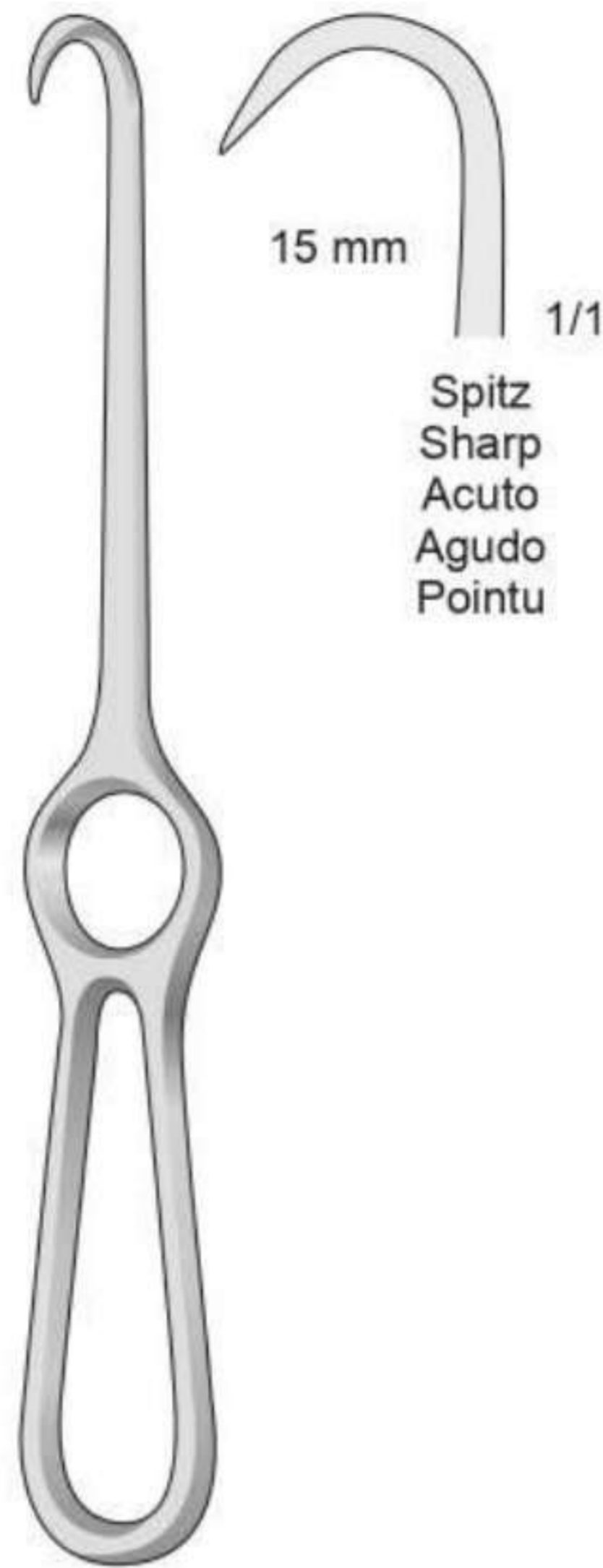

KOCHER
BT-139
205 mm

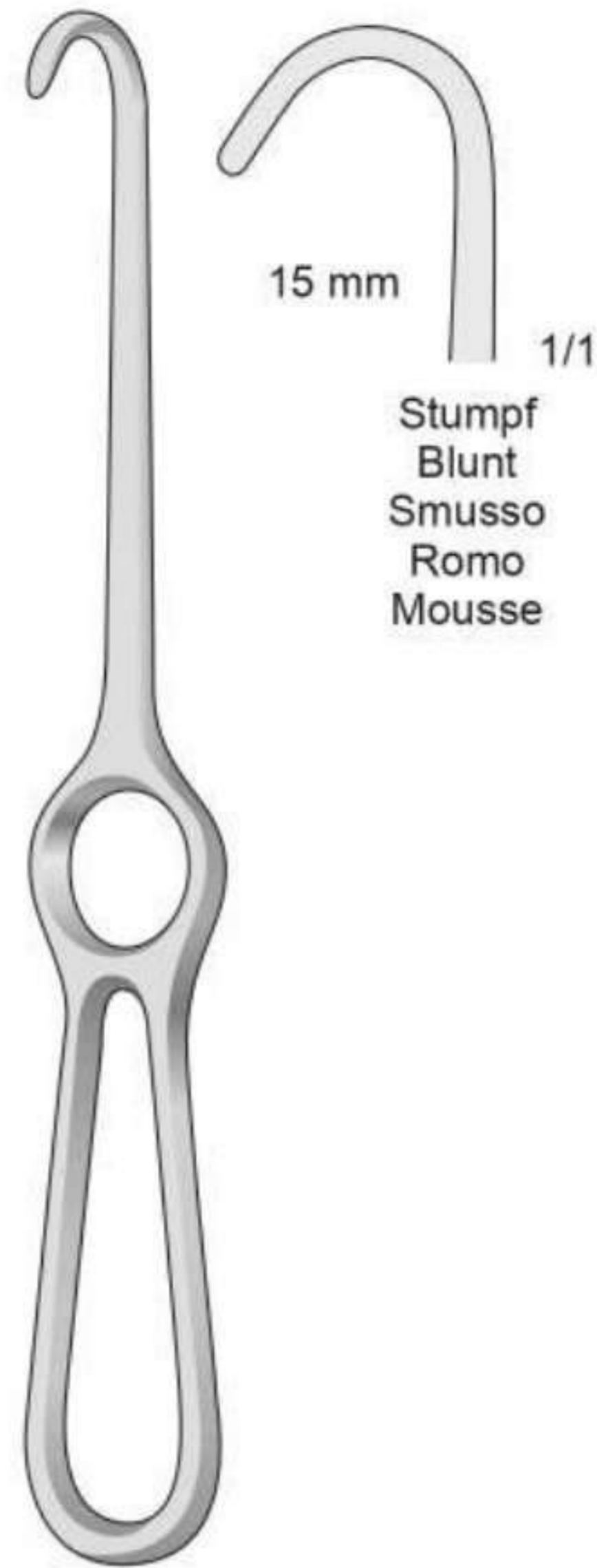

KOCHER
BT-140
220 mm

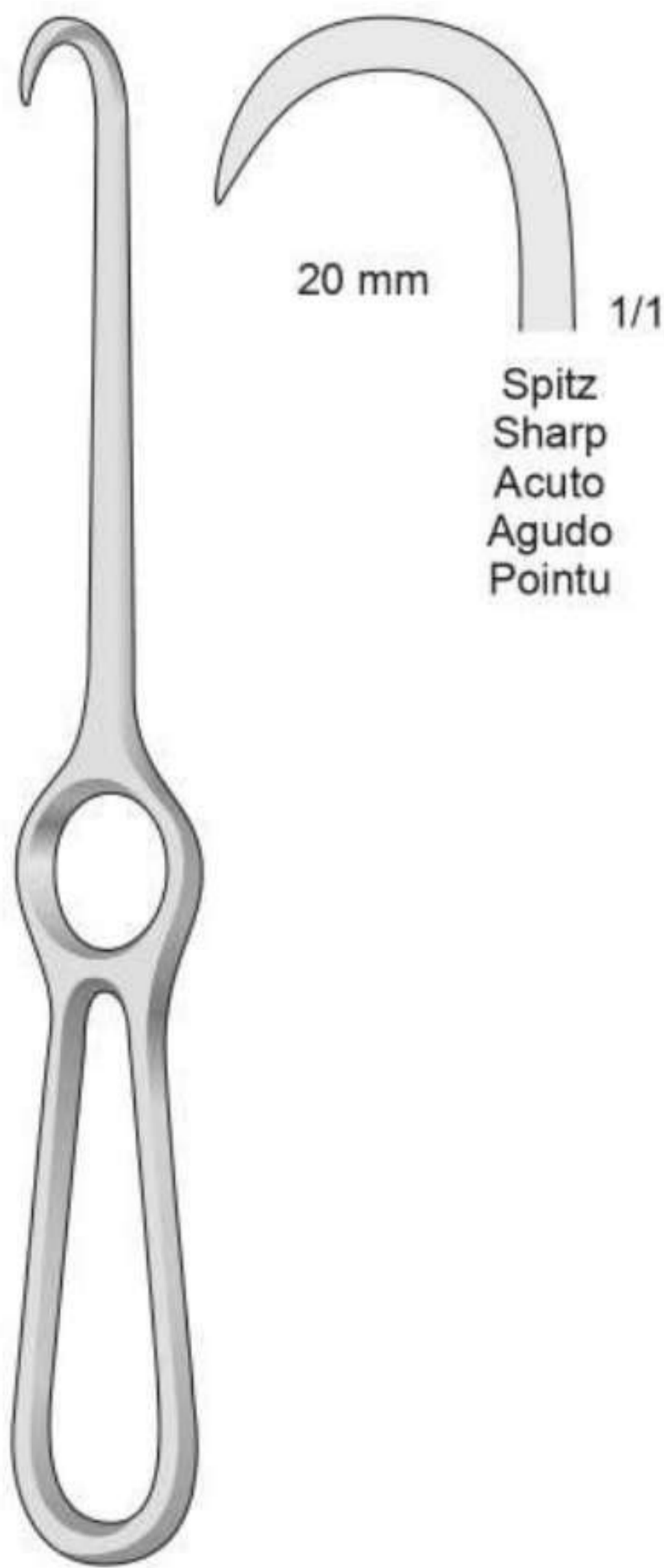

VOLKMANN
BT-126
220 mm

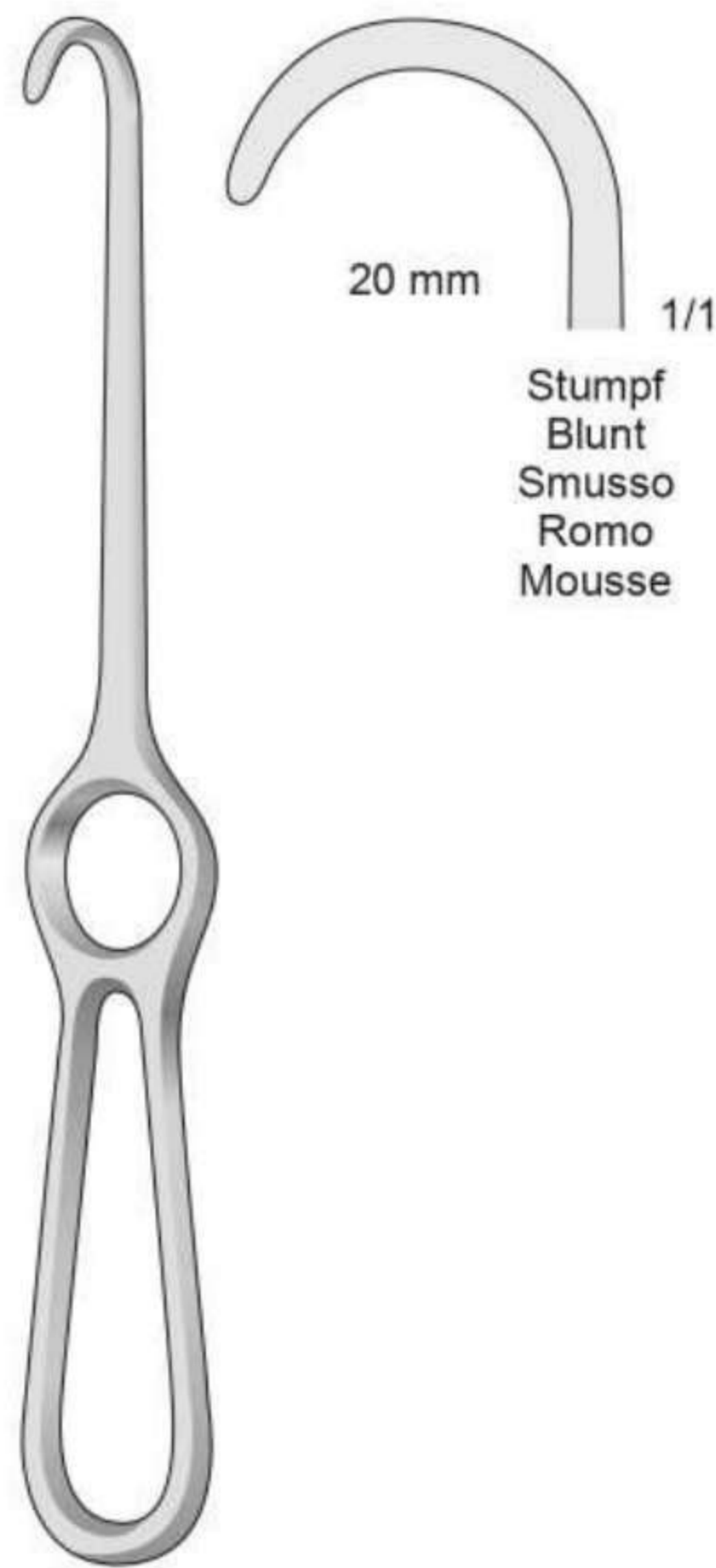

VOLKMANN
BT-127
220 mm

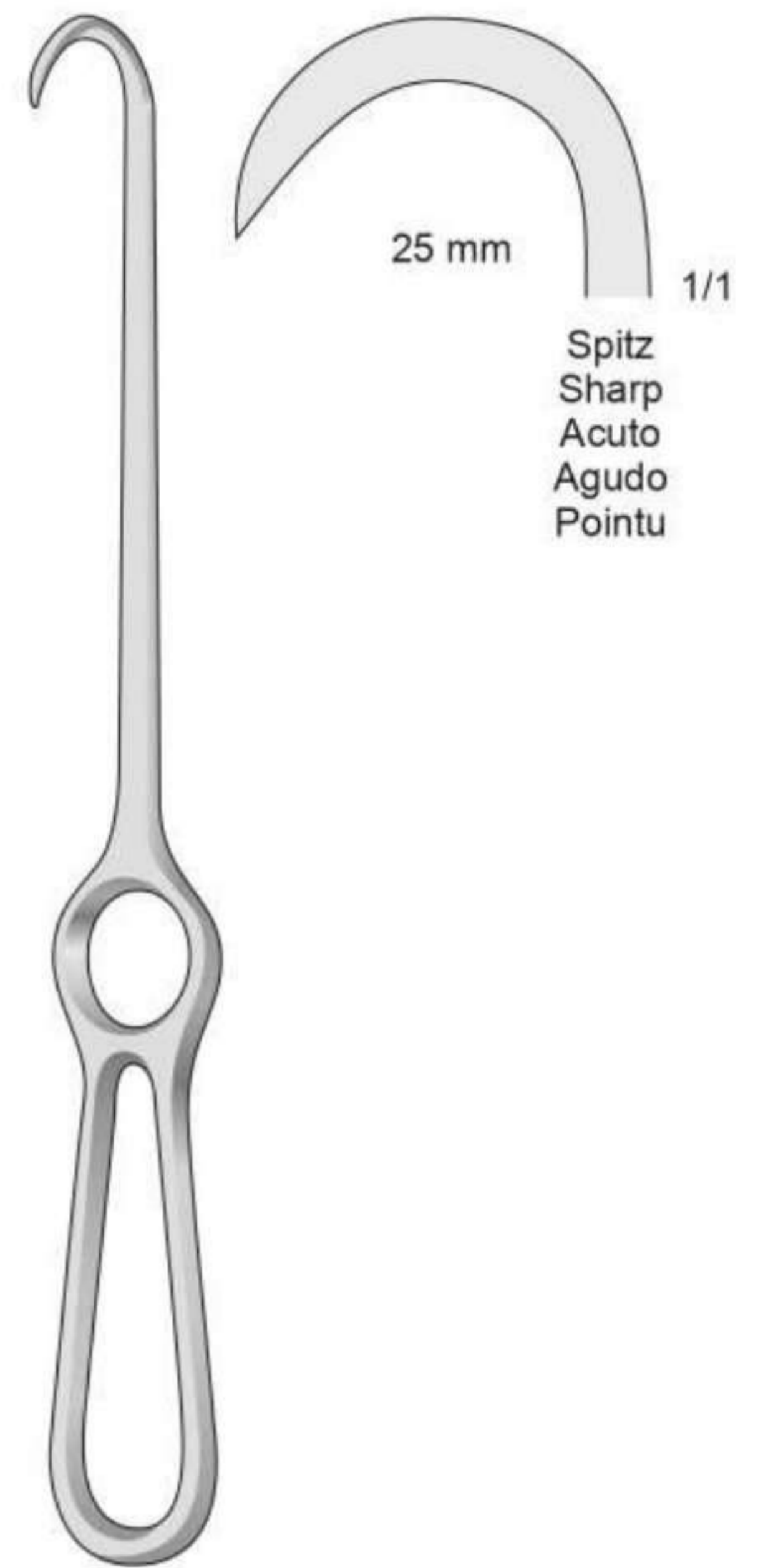

BT-128
245 mm

15 mm 1/1
Spitz
Sharp
Acuto
Agudo
Pointu

15 mm 1/1
Stumpf
Blunt
Smusso
Romo
Mousse

20 mm 1/1
Spitz
Sharp
Acuto
Agudo
Pointu

20 mm 1/1
Stumpf
Blunt
Smusso
Romo
Mousse

25 mm 1/1
Spitz
Sharp
Acuto
Agudo
Pointu

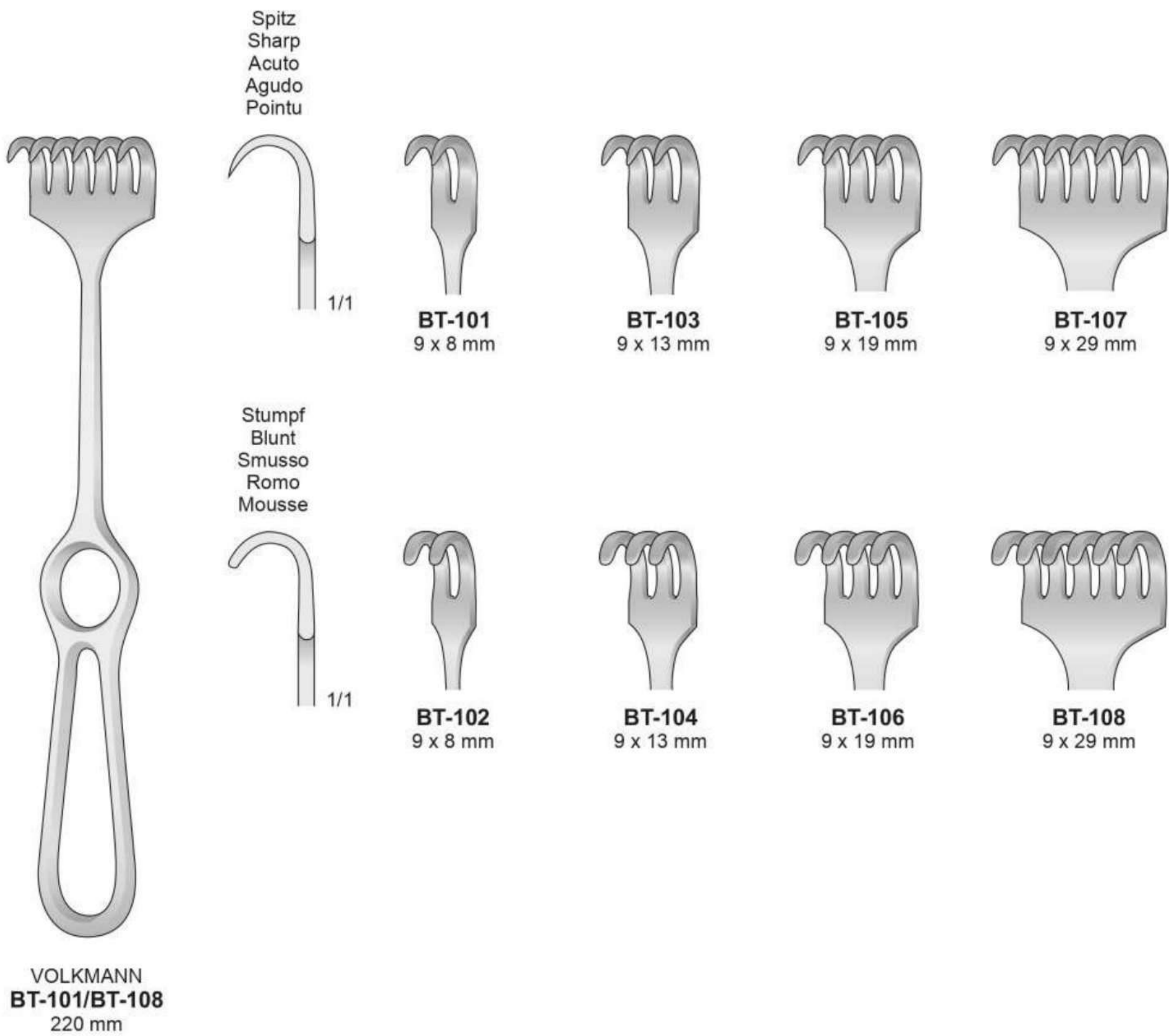

Wundhaken

Retractors

Divaricatori

Separadores

Écarteurs

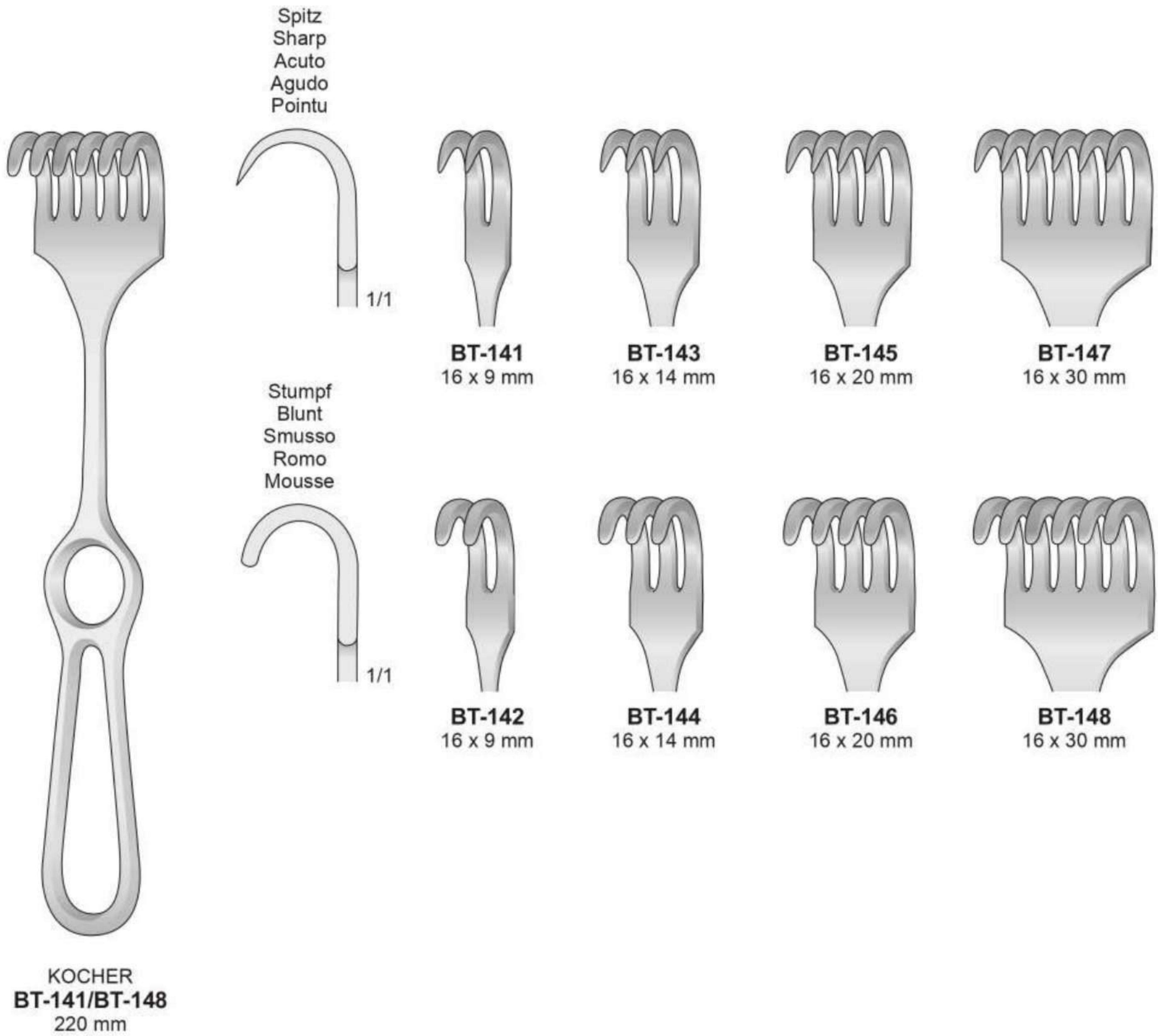

Wundhaken

Retractors

Divaricatori

Separadores

Écarteurs

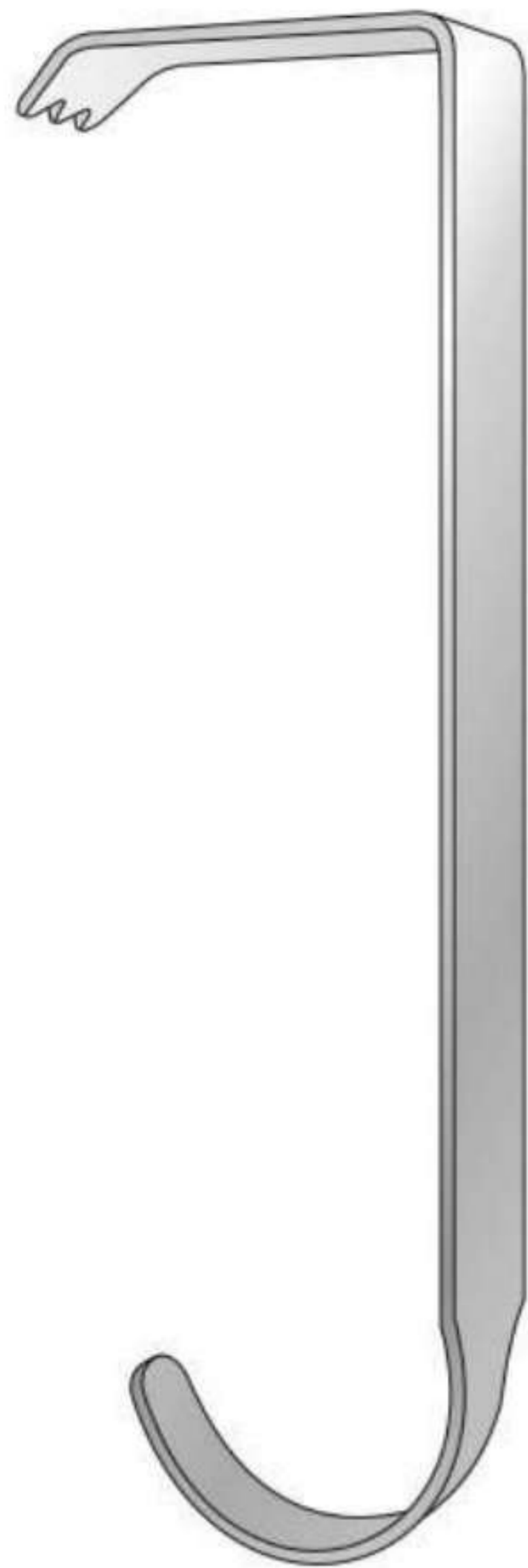

HIBBS
BT-23/BT-24
240 mm

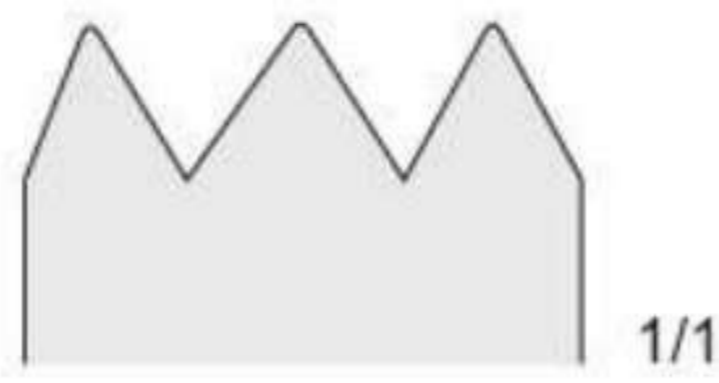

1/1

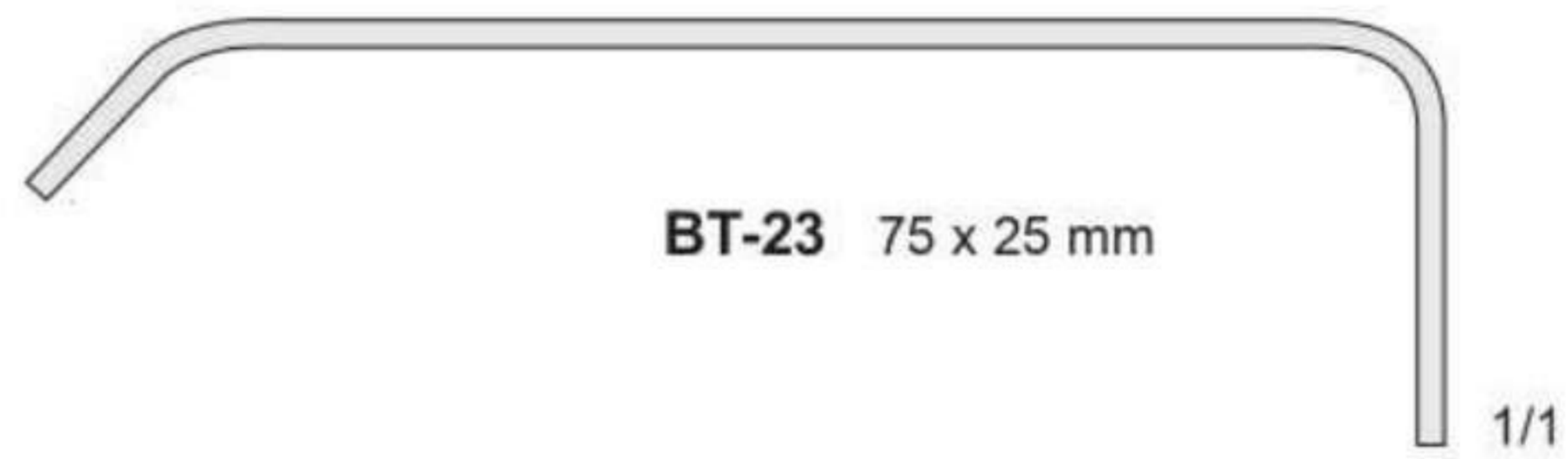

BT-23 75 x 25 mm

1/1

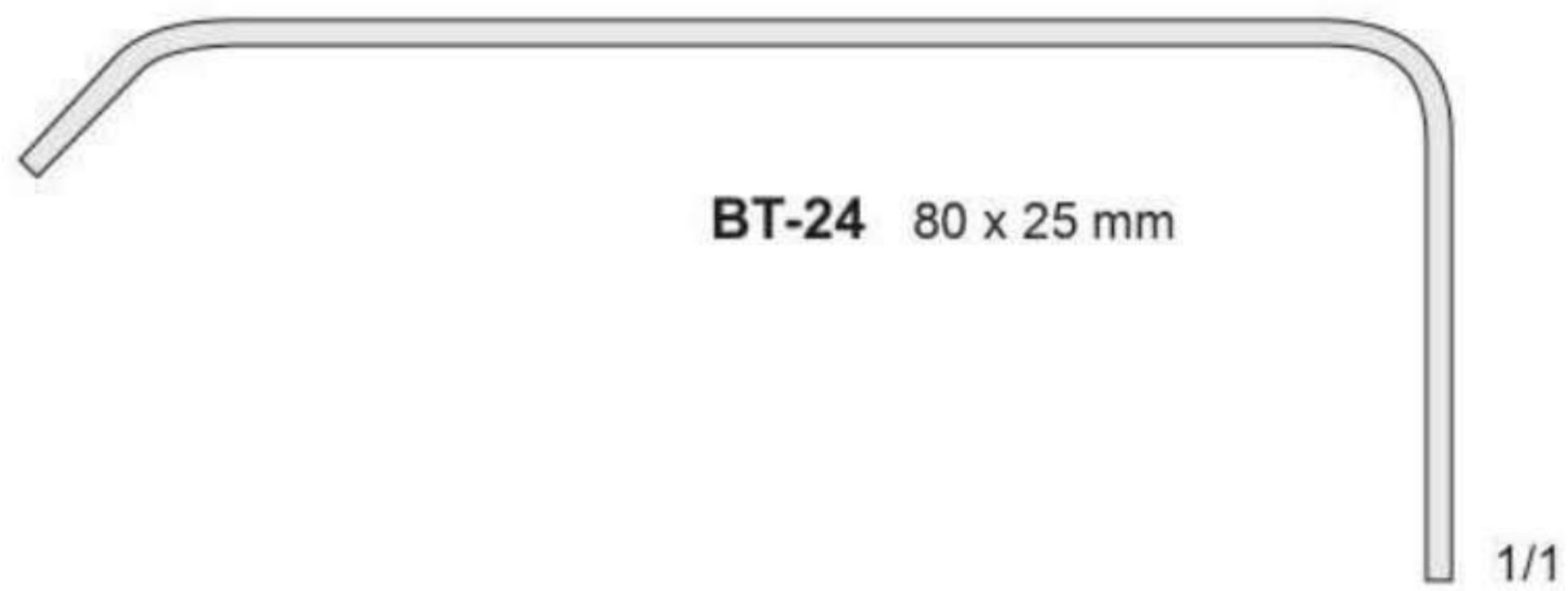

BT-24 80 x 25 mm

1/1

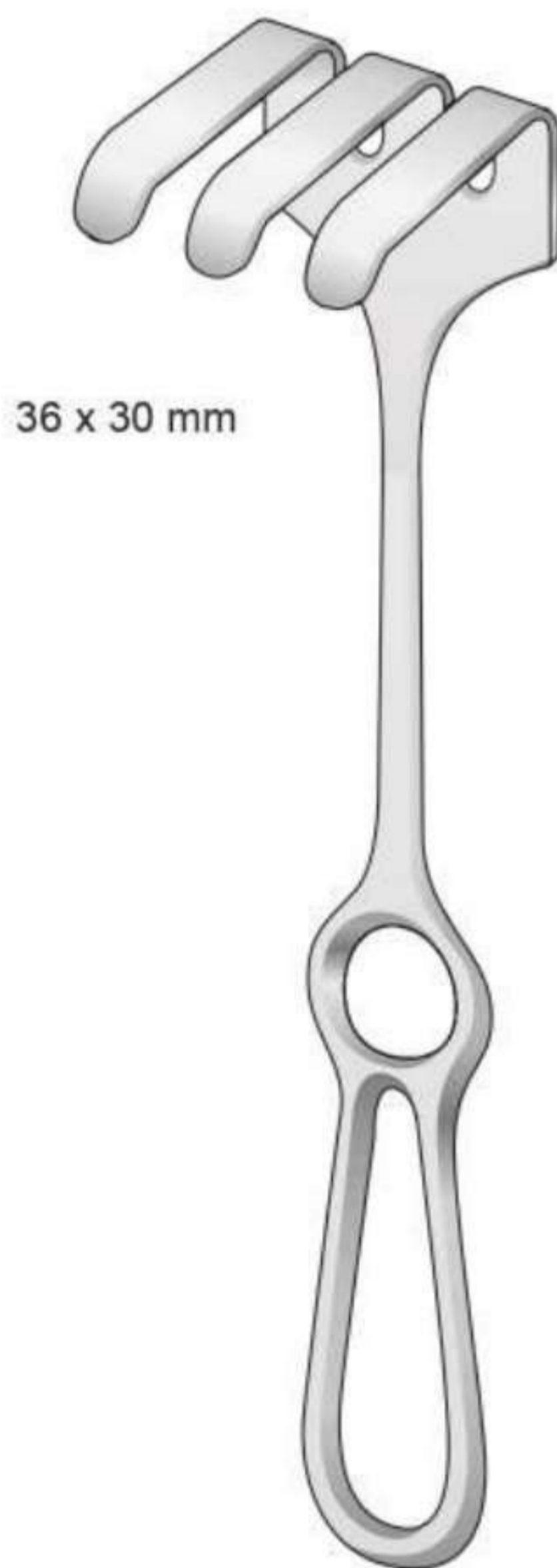

36 x 30 mm

OLLIER
BT-124
225 mm



1/1

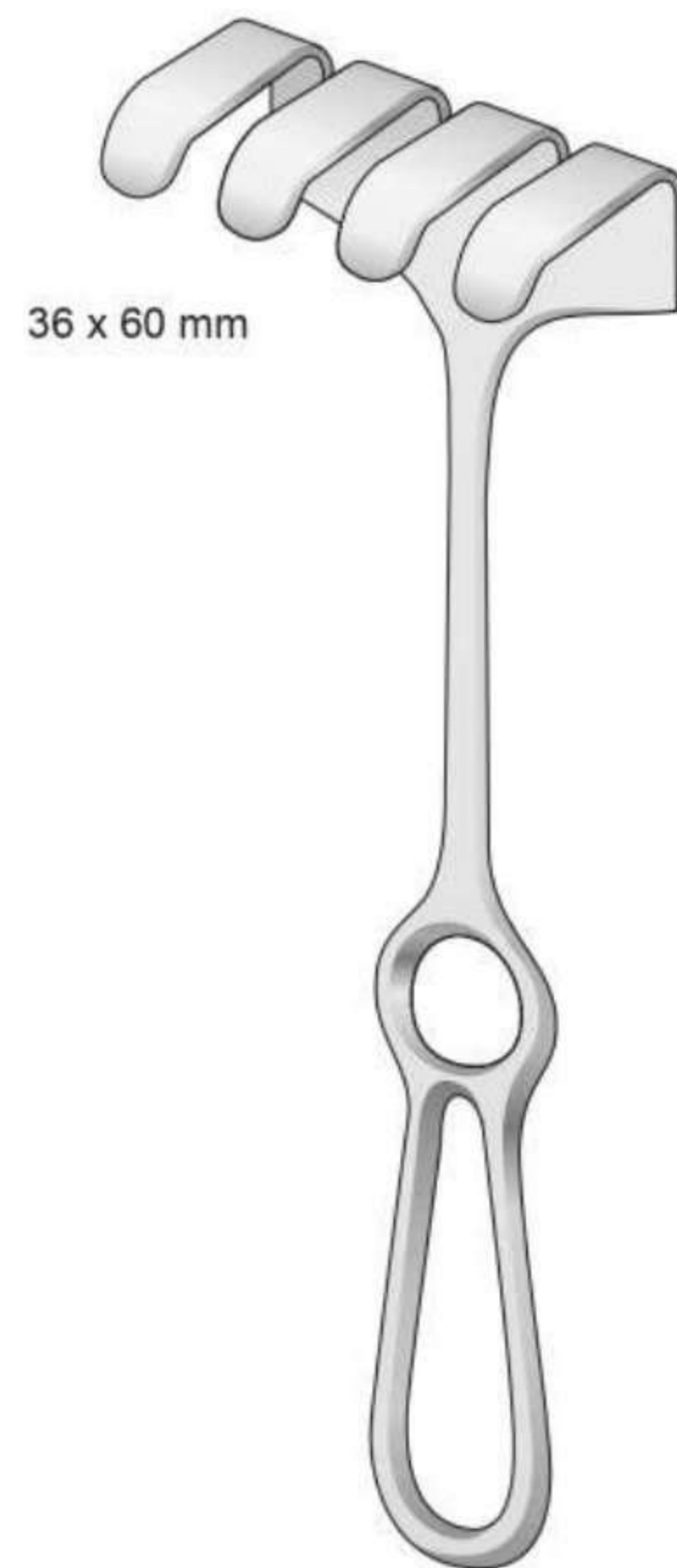

36 x 60 mm

OLLIER
BT-125
225 mm

40 x 40 mm

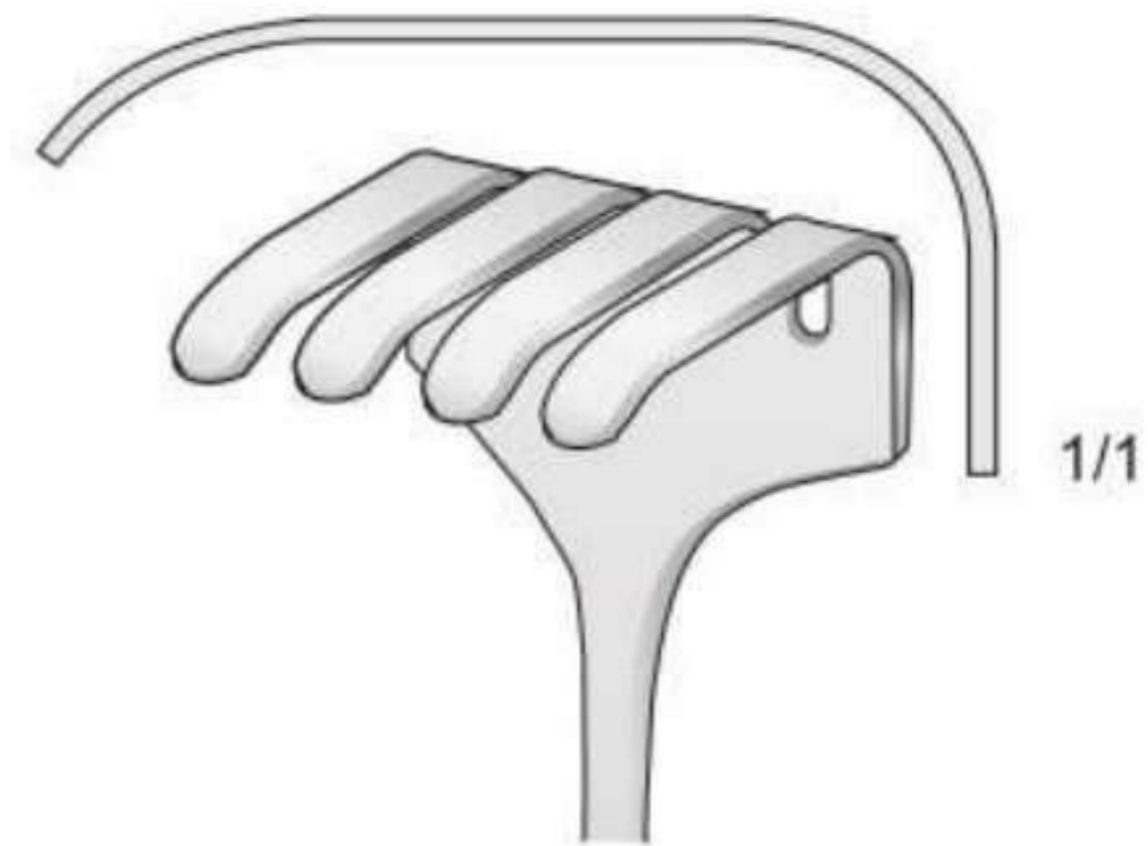

BT-120

45 x 50 mm

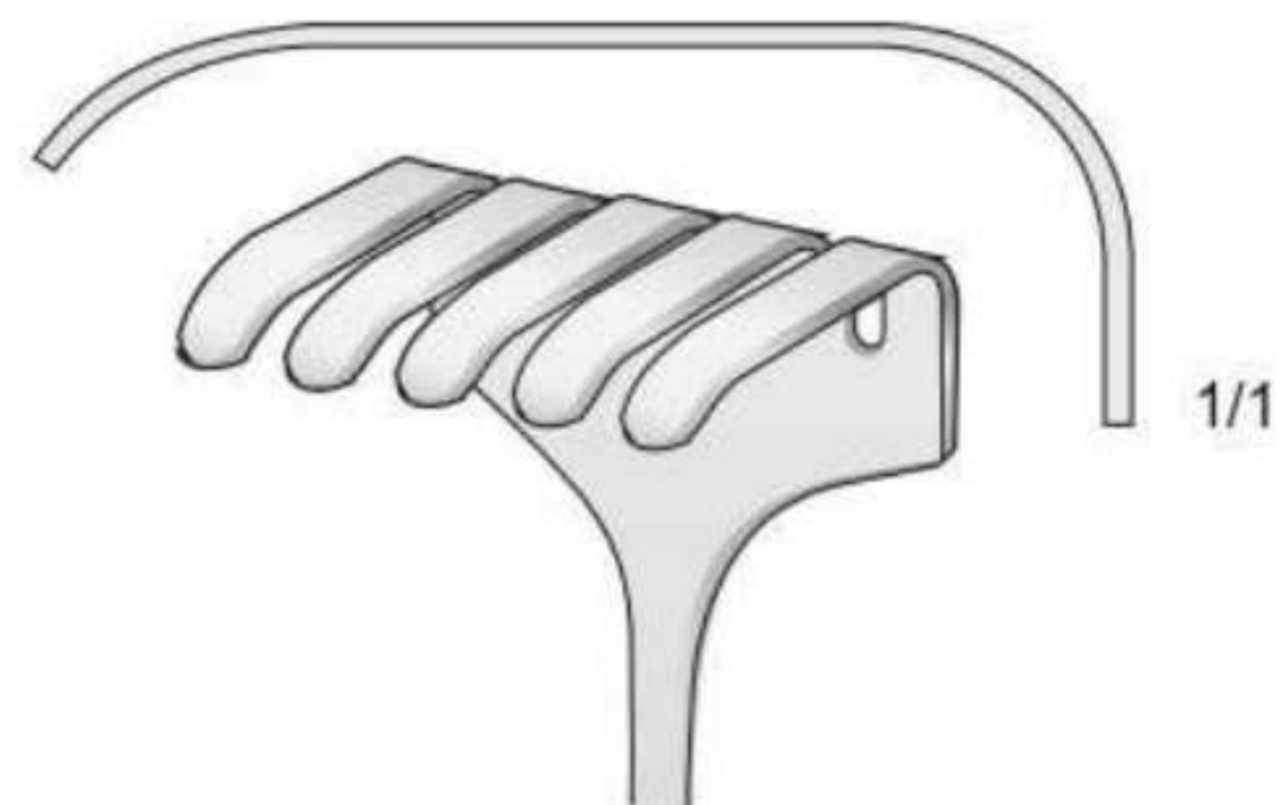

BT-121

50 x 60 mm

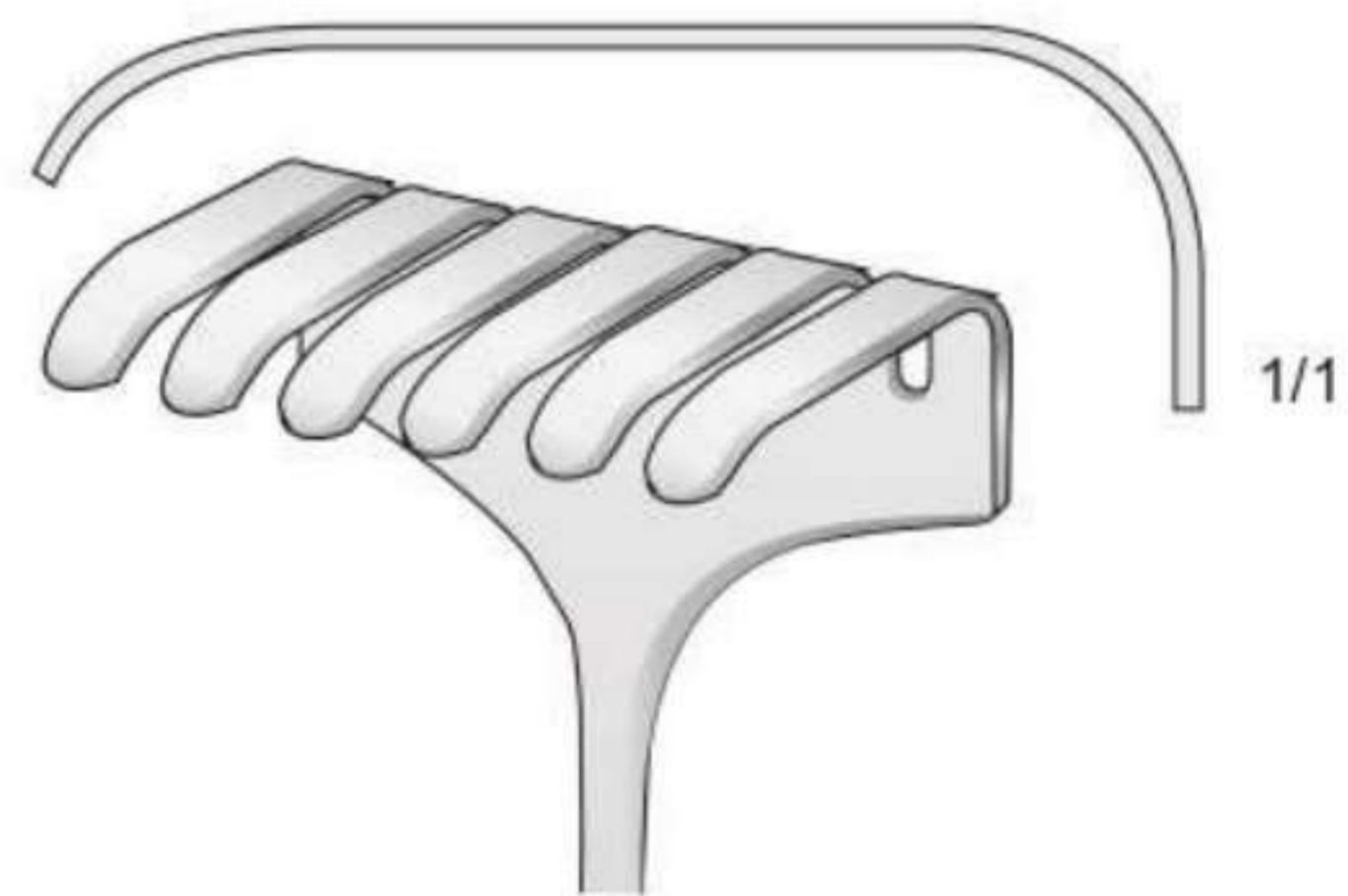

BT-122

70 x 70 mm

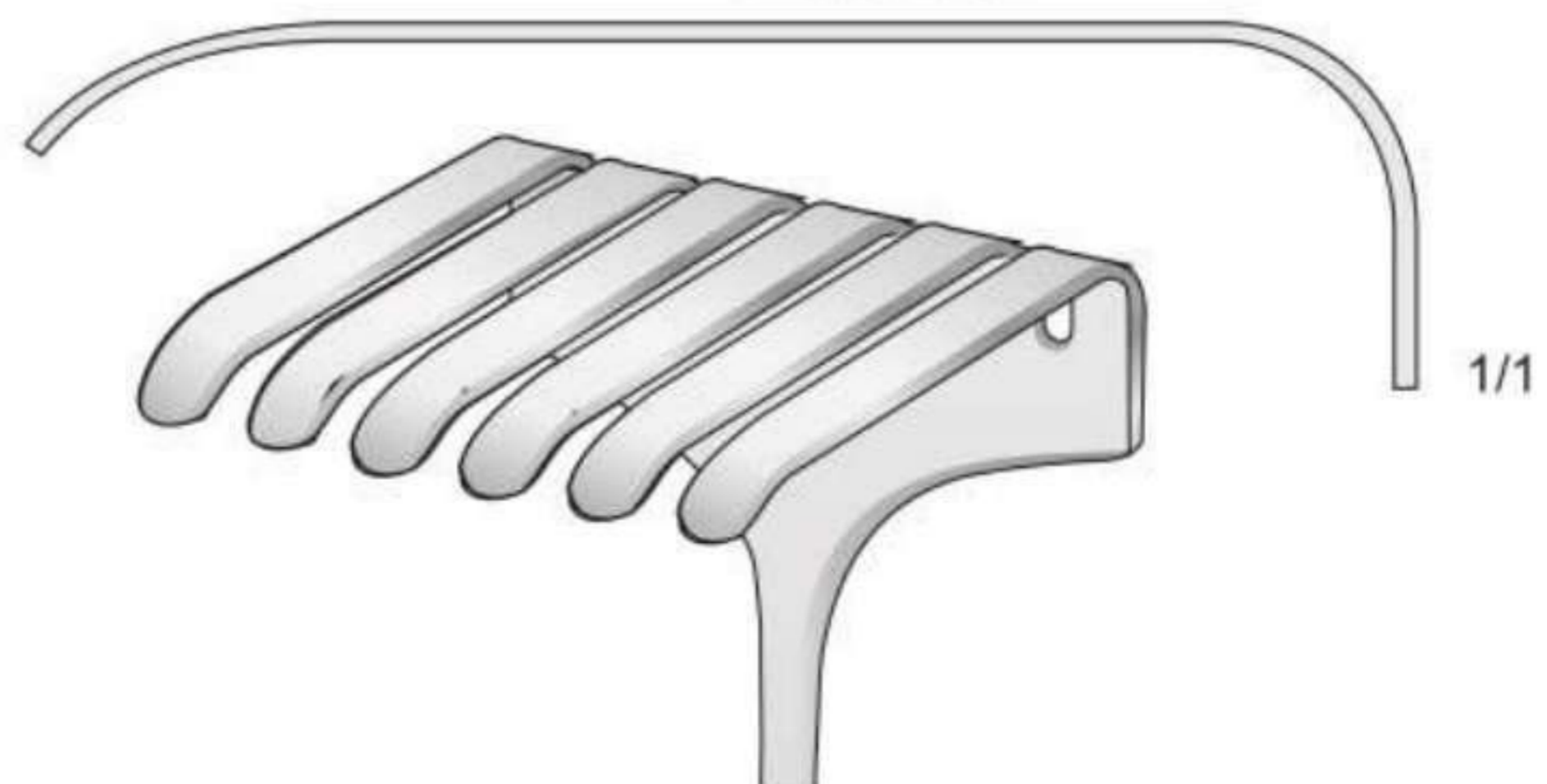

BT-123

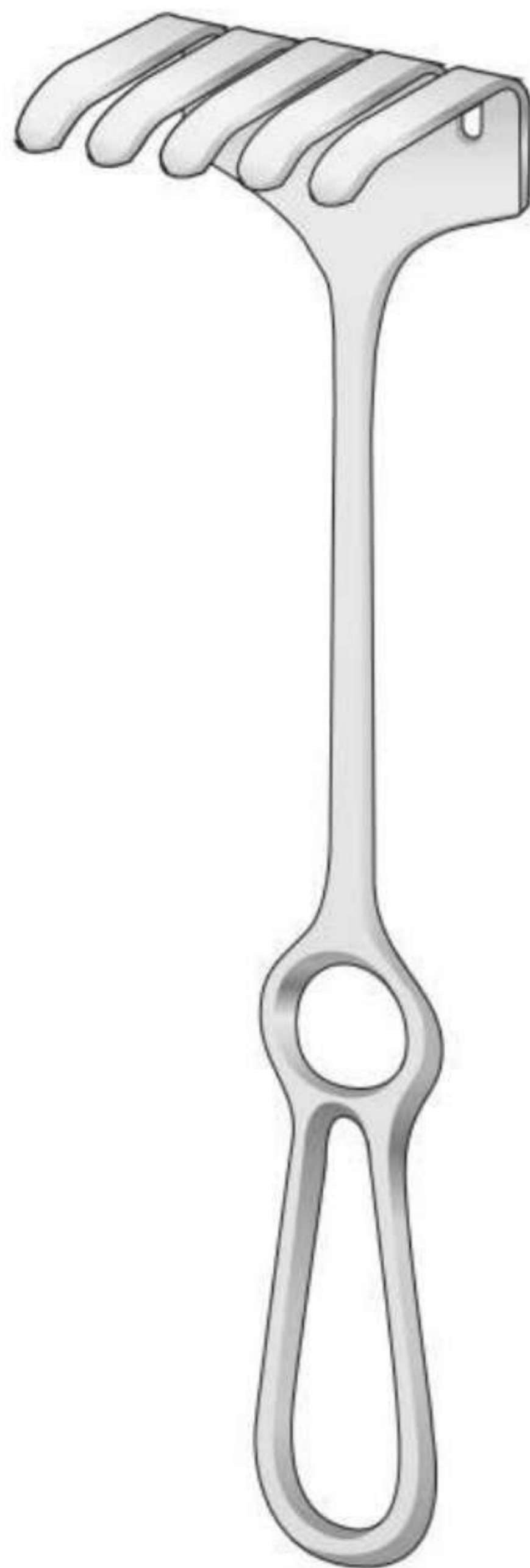

ISRAEL
BT-120/BT-123
250 mm

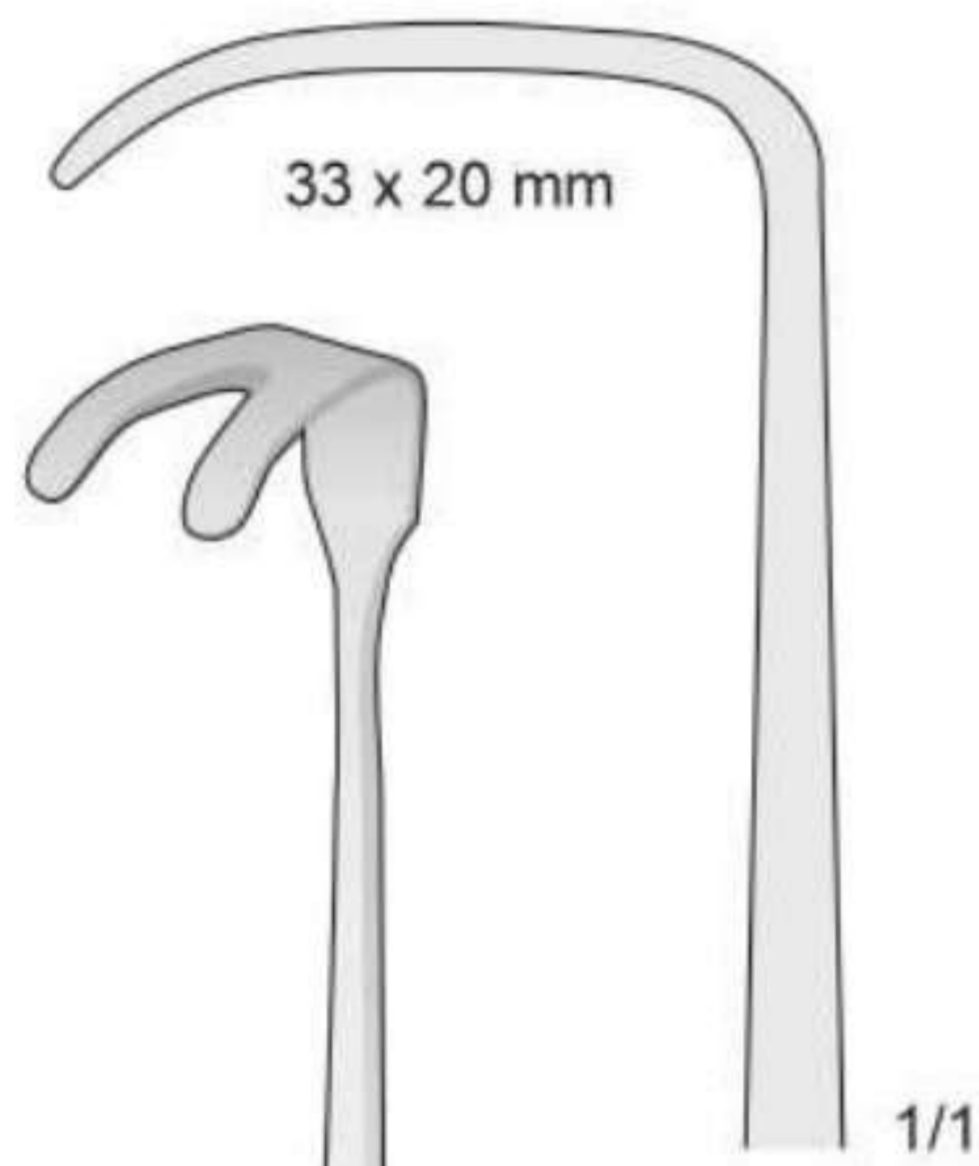

WASSMUND
BT-69
 220 mm



LANGENBECK
BT-33/BT-43
 210 mm

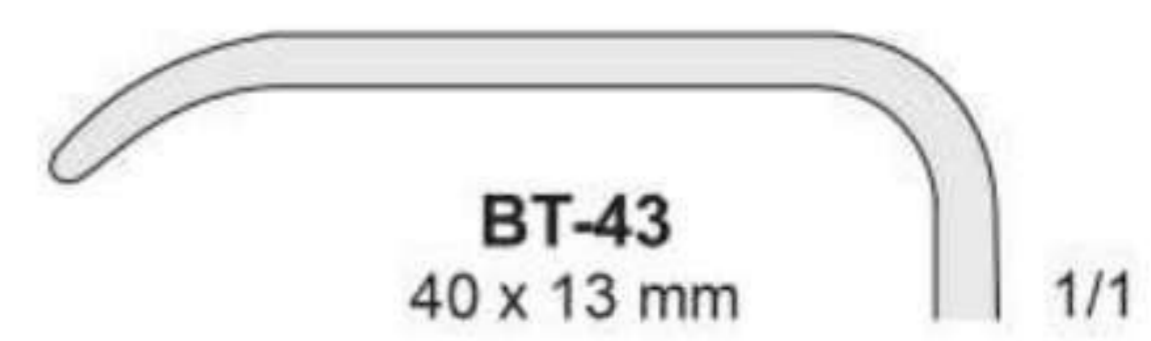
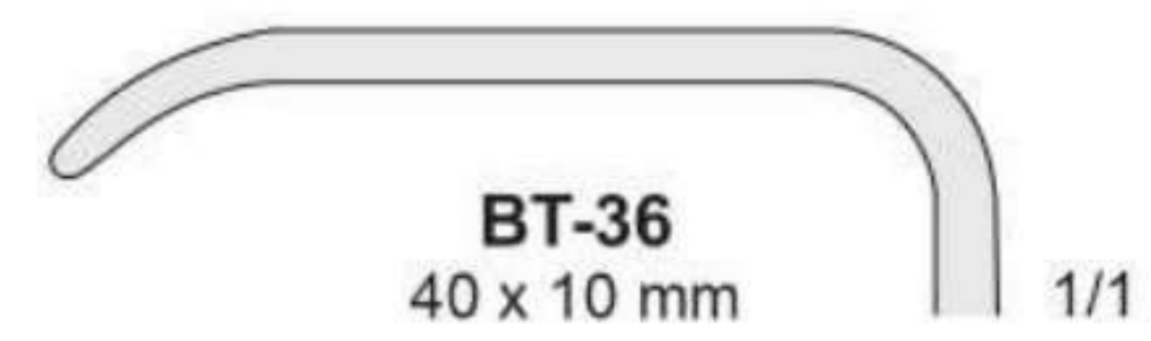

Wundhaken

Retractors

Divaricatori

Separadores

Écarteurs



KOCHER-LANGENBECK
BT-60/BT-263
215 mm

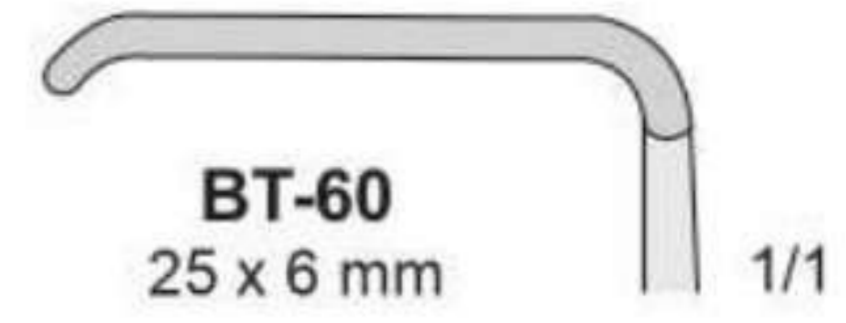

BT-60
25 x 6 mm

1/1

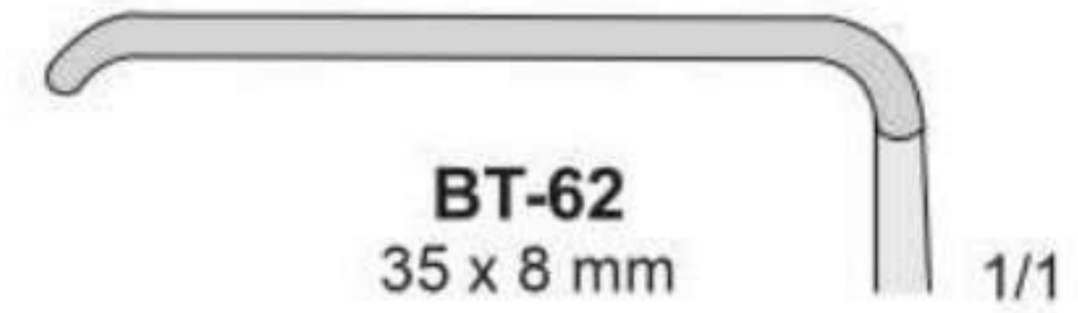

BT-62
35 x 8 mm

1/1

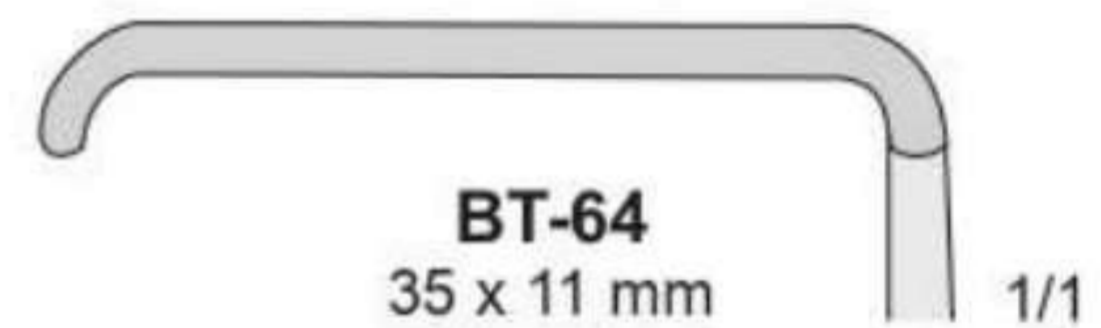

BT-64
35 x 11 mm

1/1

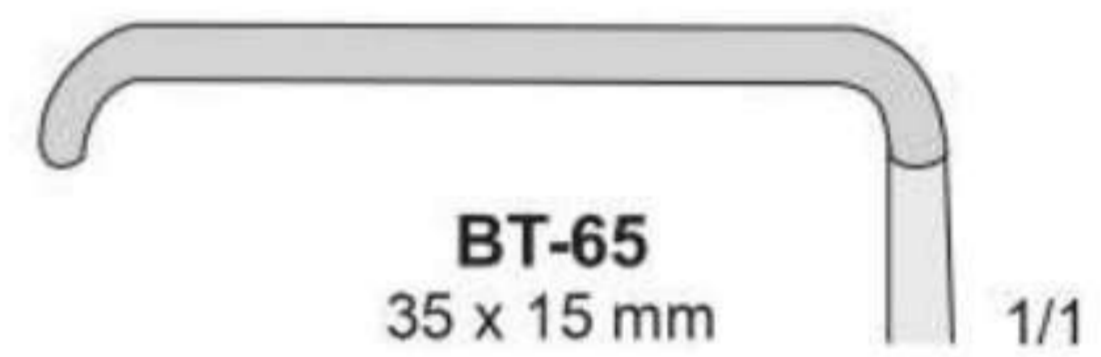

BT-65
35 x 15 mm

1/1

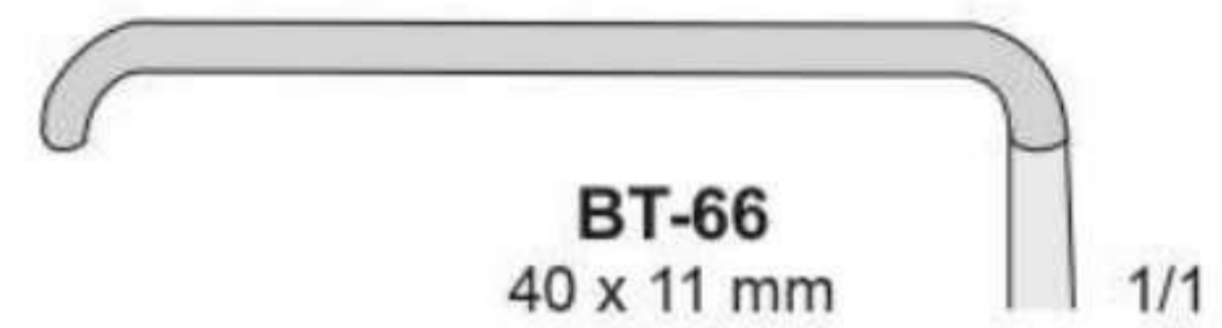

BT-66
40 x 11 mm

1/1

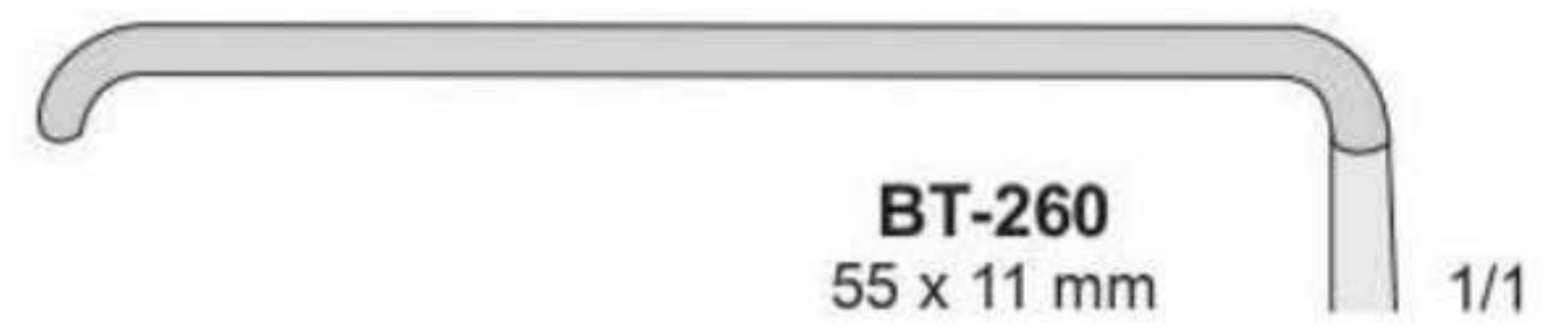

BT-260
55 x 11 mm

1/1



BT-261
70 x 14 mm

1/1

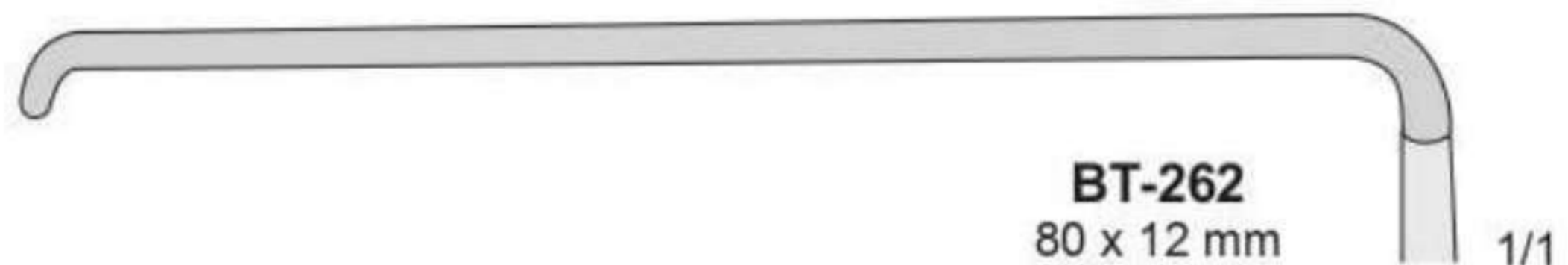

BT-262
80 x 12 mm

1/1



BT-263
80 x 16 mm

1/1

Wundhaken

Retractors

Divaricatori

Separadores

Écarteurs



SAUERBRUCH
BT-110/BT-112
225 mm



BT-110
46 x 16 mm 1/1



BT-111
55 x 22 mm 1/1



BT-112
72 x 19 mm 1/1



KOCHER
BT-250/BT-254
230 mm

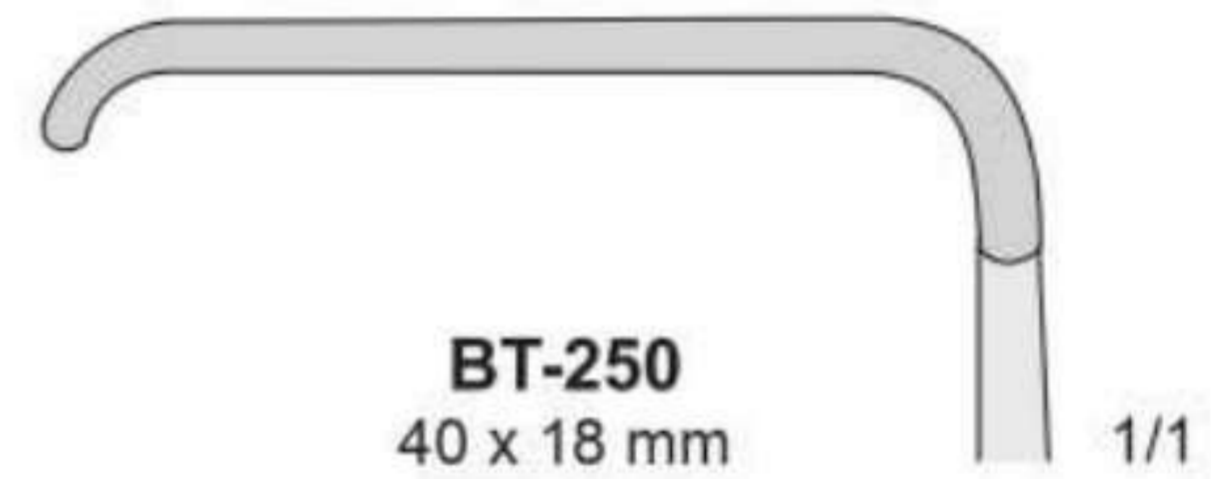

BT-250
40 x 18 mm 1/1

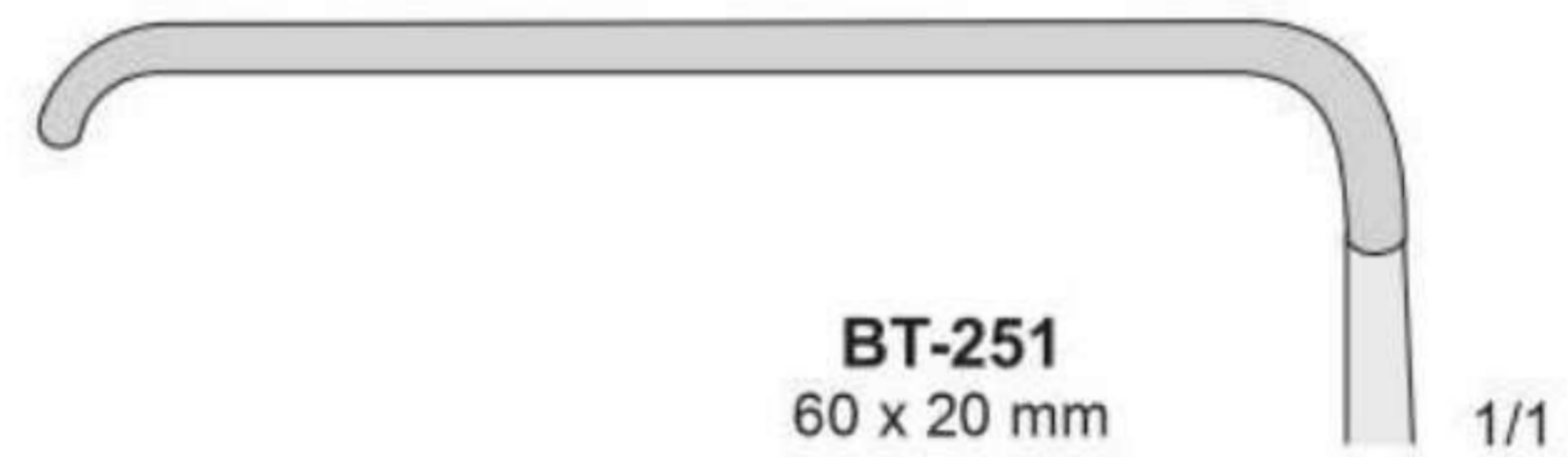

BT-251
60 x 20 mm 1/1

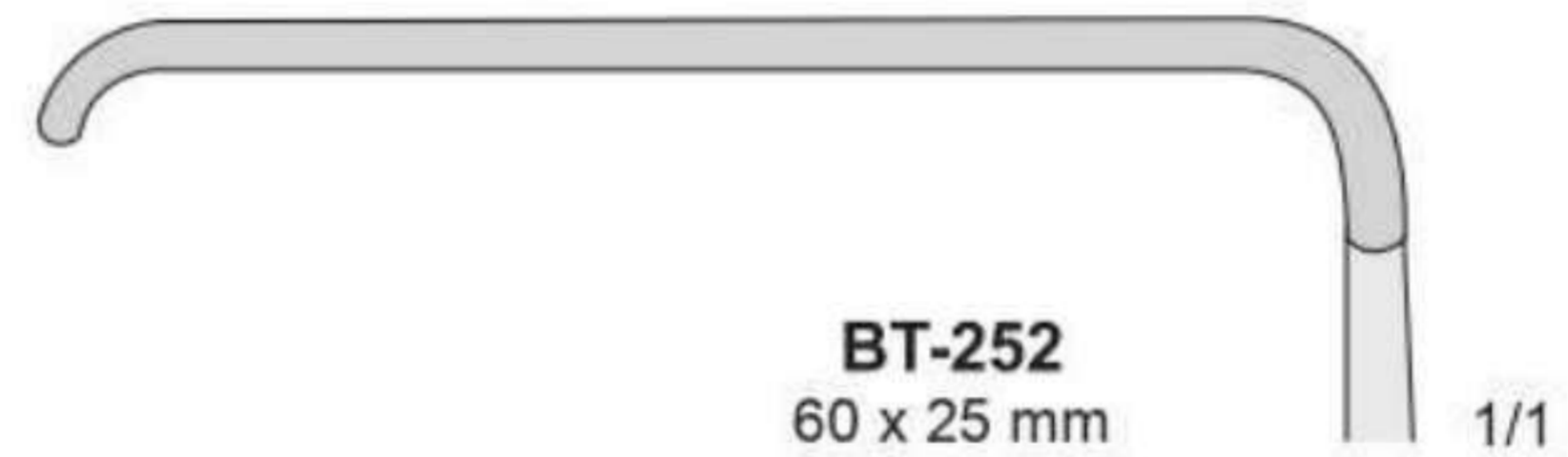

BT-252
60 x 25 mm 1/1

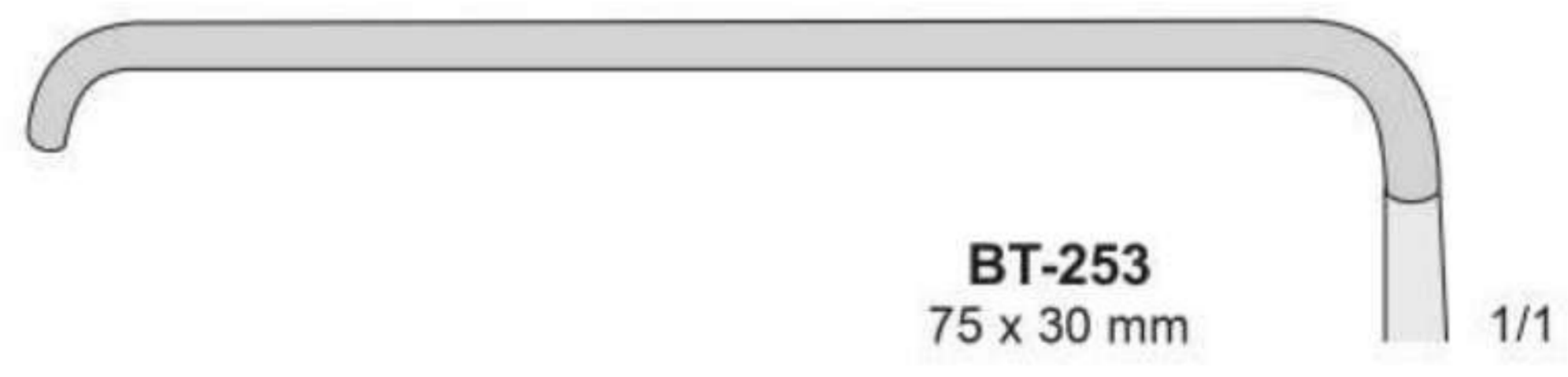

BT-253
75 x 30 mm 1/1

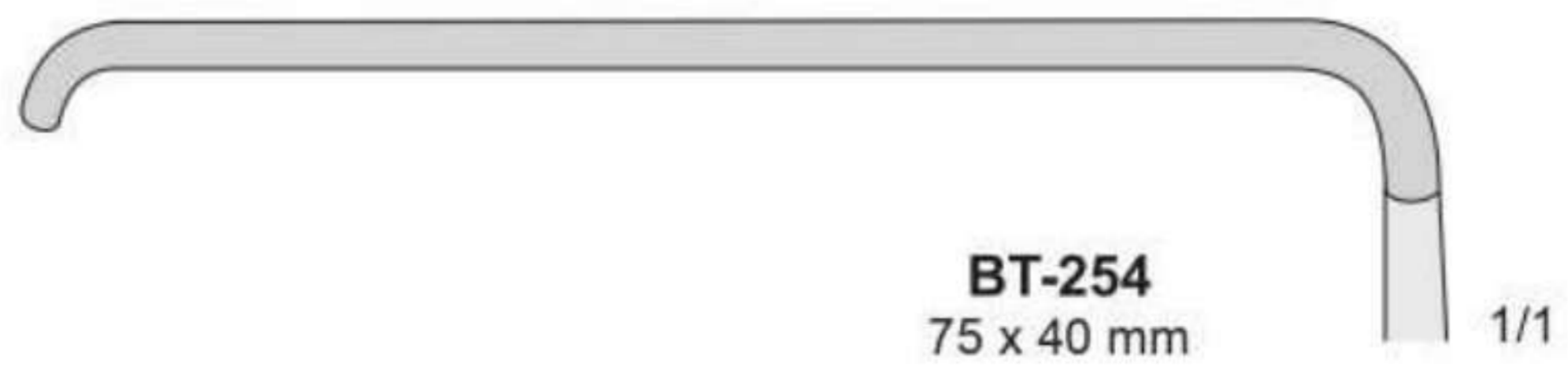

BT-254
75 x 40 mm 1/1

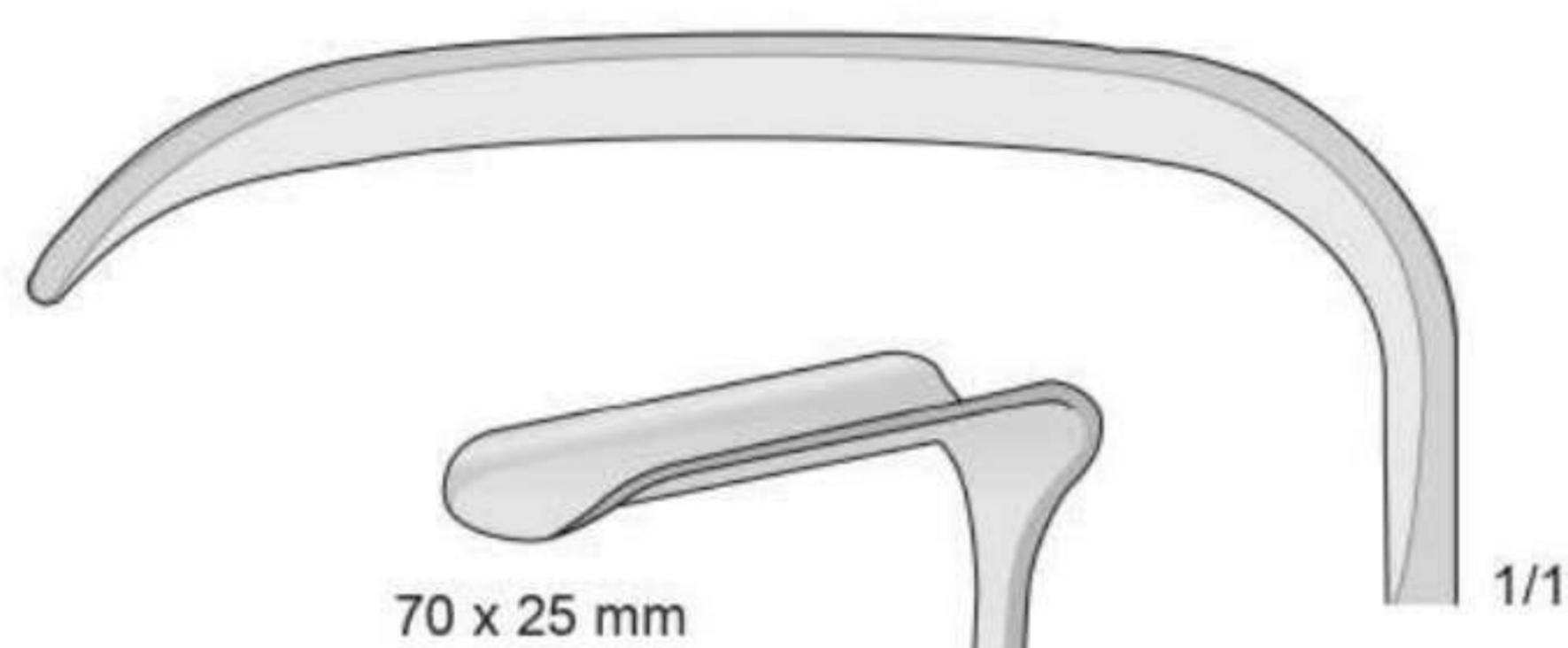

70 x 25 mm

1/1



BT-135
55 x 14 mm

1/1



BT-134
40 x 12 mm

1/1



KOCHER
BT-137
240 mm

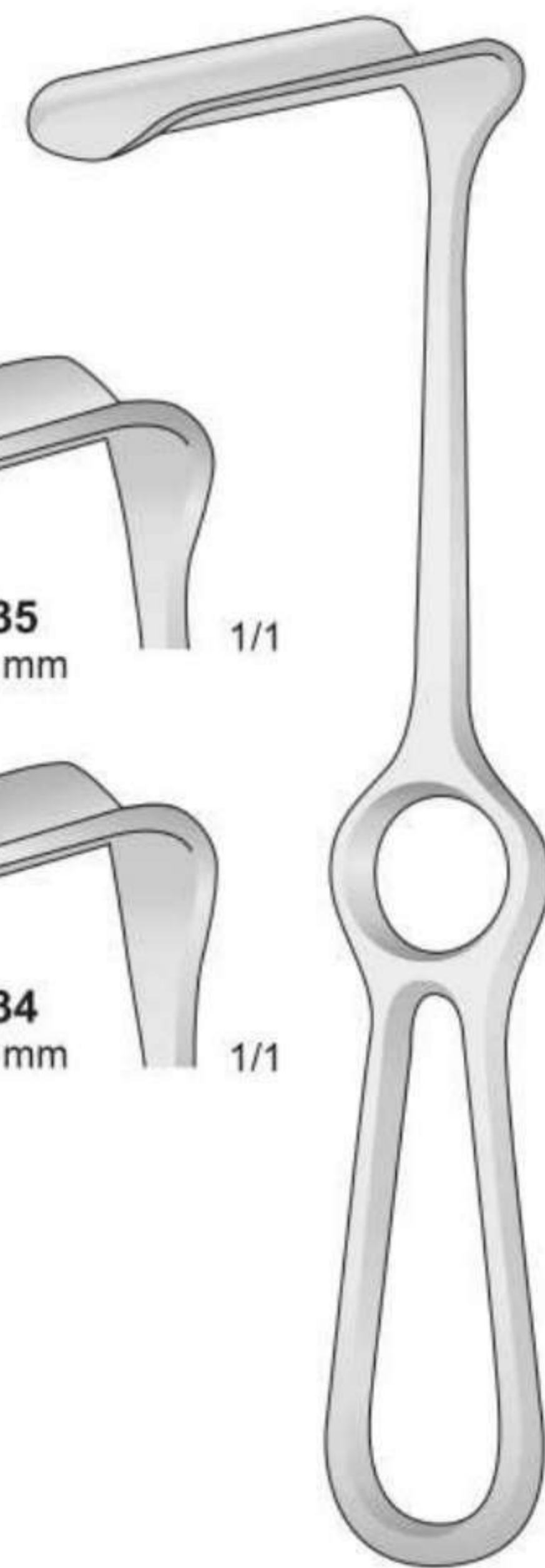

DOCKHORN
BT-134/BT-135
210 mm

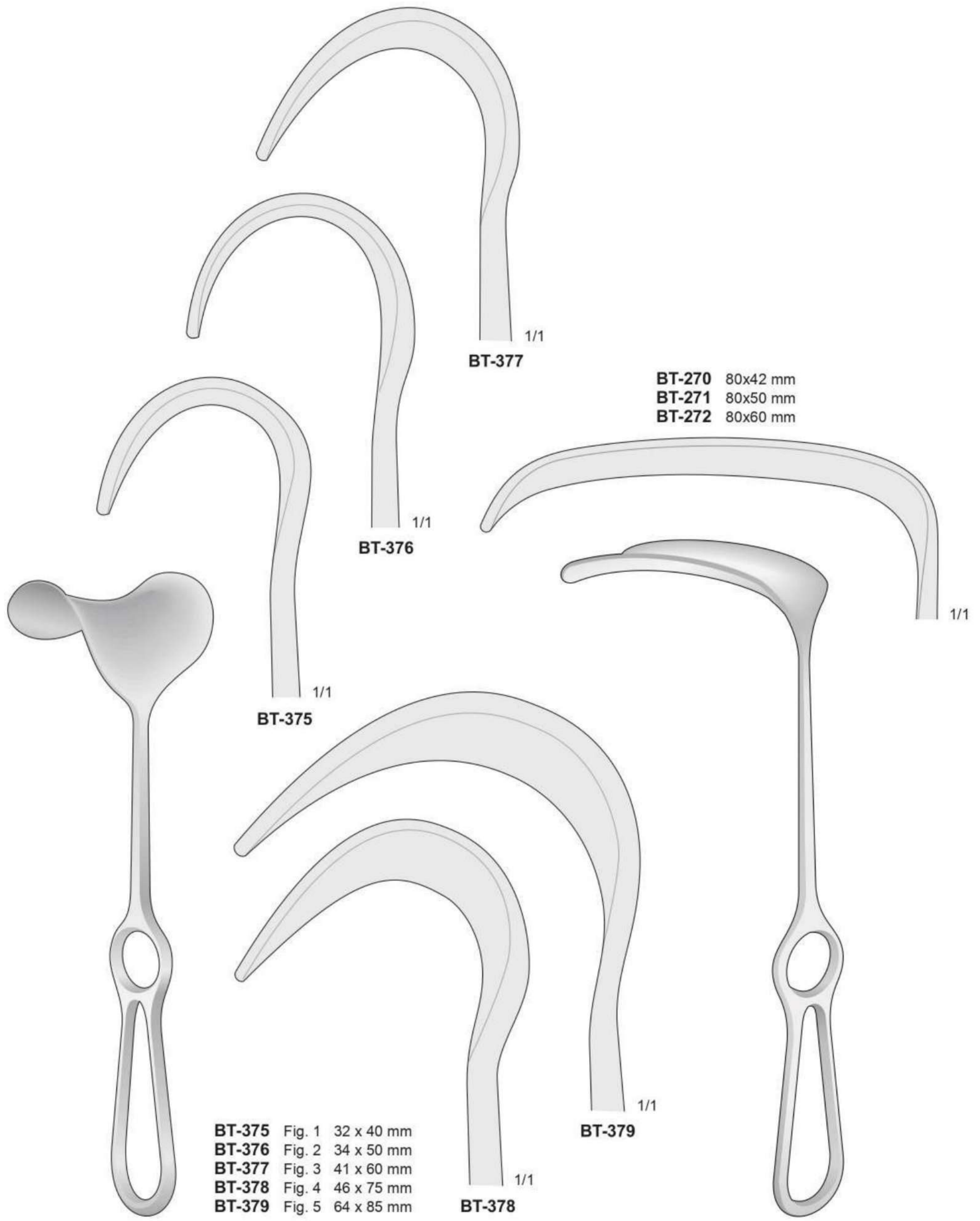

BT-270 80x42 mm
 BT-271 80x50 mm
 BT-272 80x60 mm

BT-375 Fig. 1 32 x 40 mm
 BT-376 Fig. 2 34 x 50 mm
 BT-377 Fig. 3 41 x 60 mm
 BT-378 Fig. 4 46 x 75 mm
 BT-379 Fig. 5 64 x 85 mm

FRITSCH
 BT-375/BT-379
 240 mm

KOCHER
 BT-270/BT-272
 250 mm

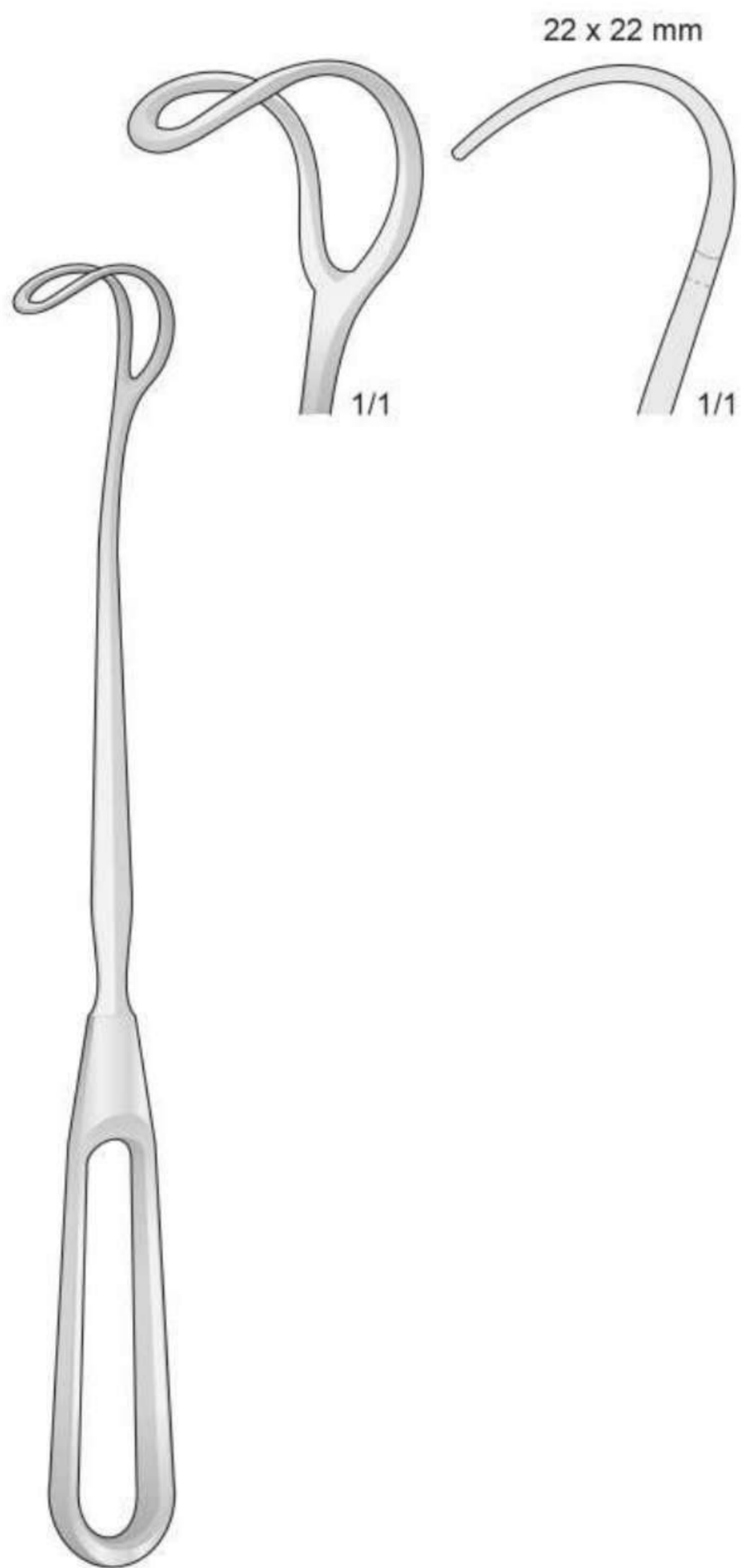

GREENE
BT-131
225 mm

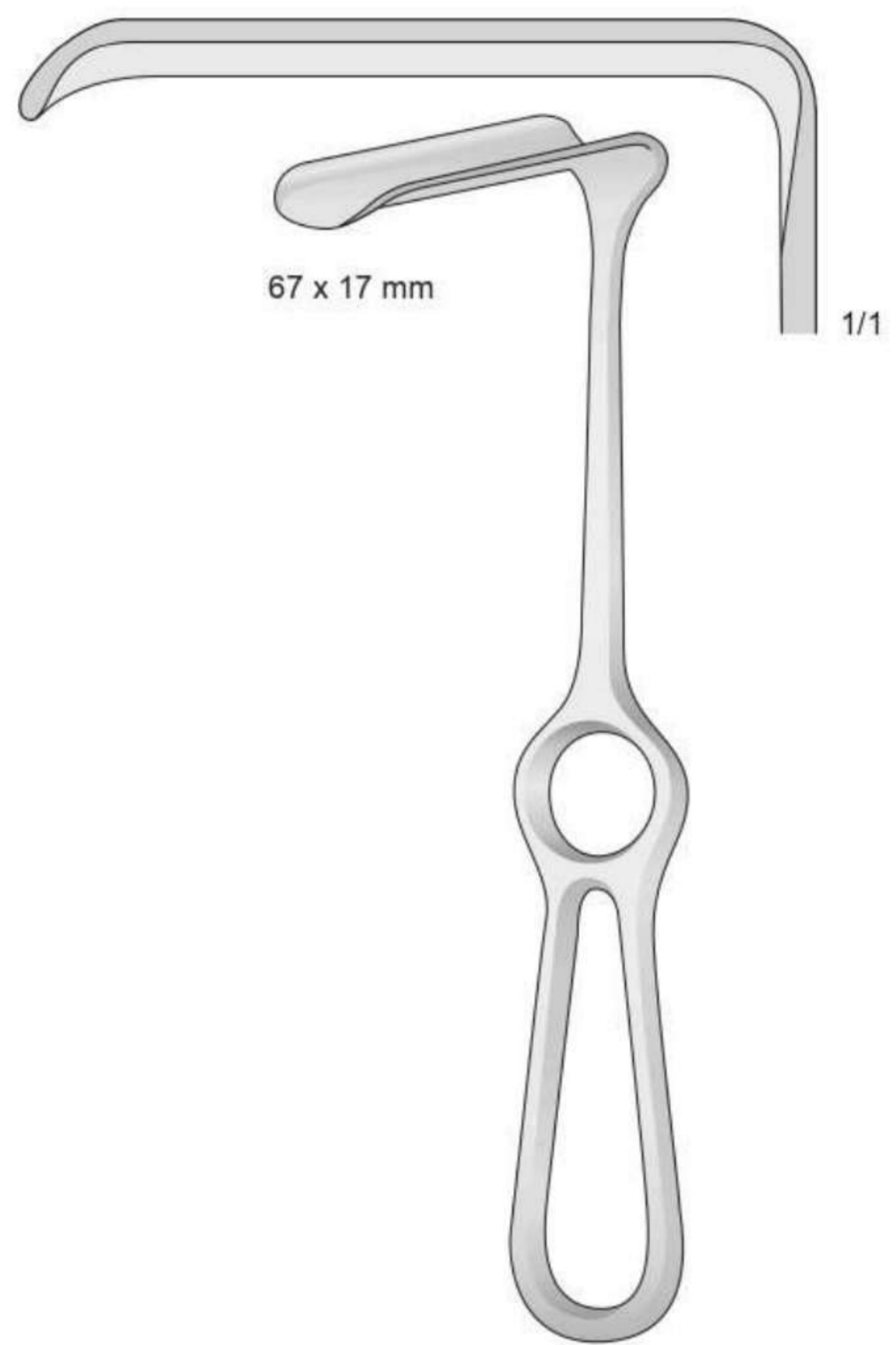

CASPAR
BT-136
210 mm

Wundhaken

Retractors

Divaricatori

Separadores

Écarteurs

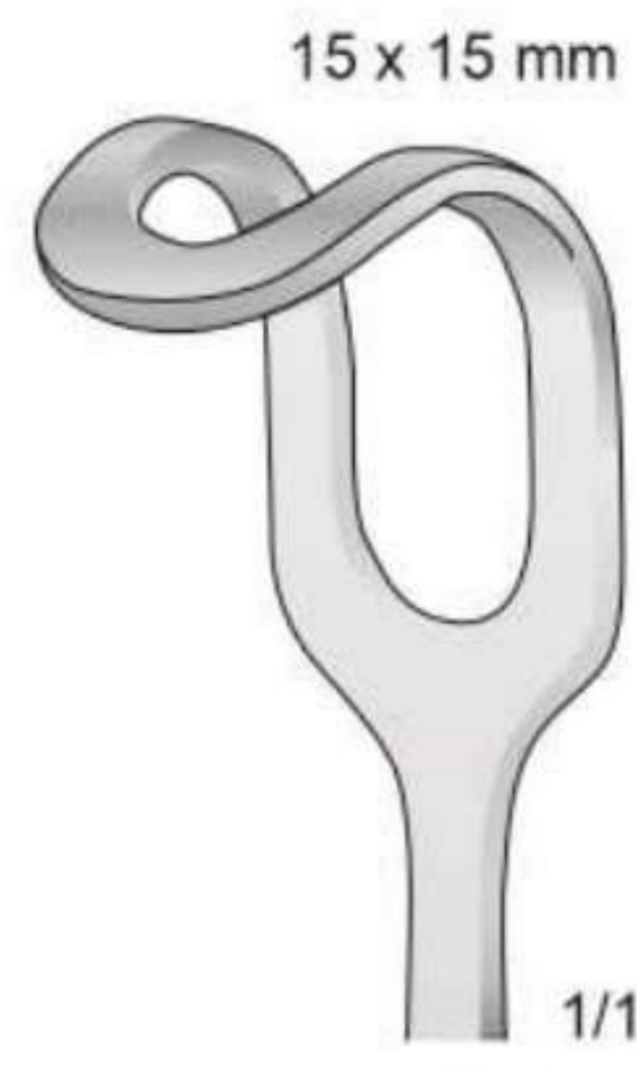

BT-80
225 mm



BT-180
255 mm

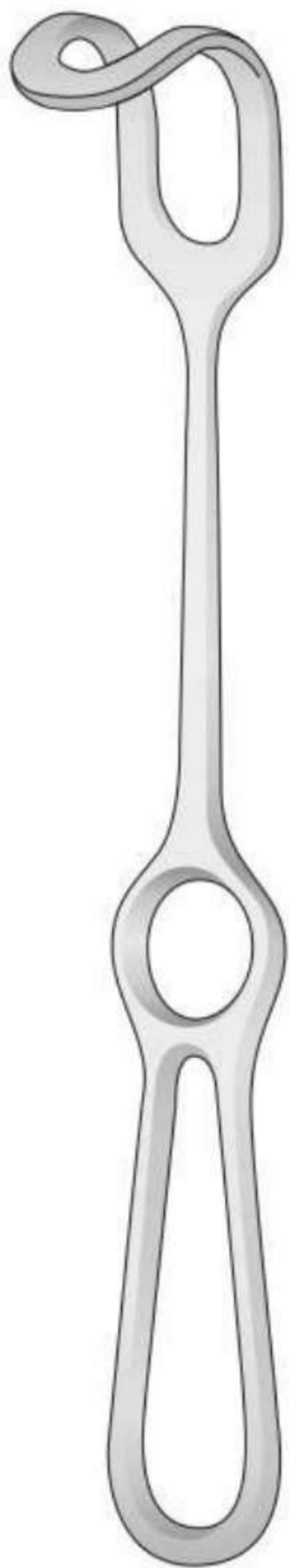

MIDDELDORPF
BT-80/BT-82
225 mm

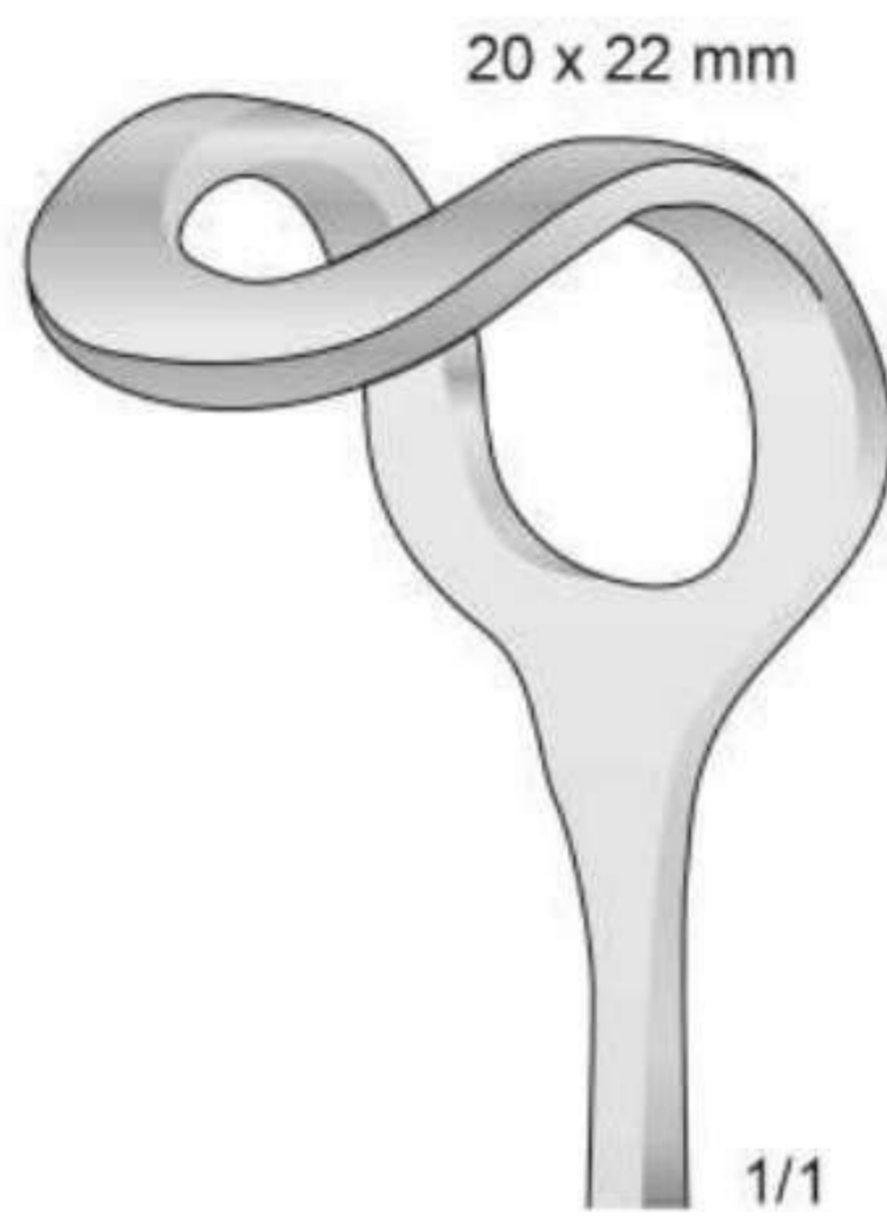

BT-81
225 mm

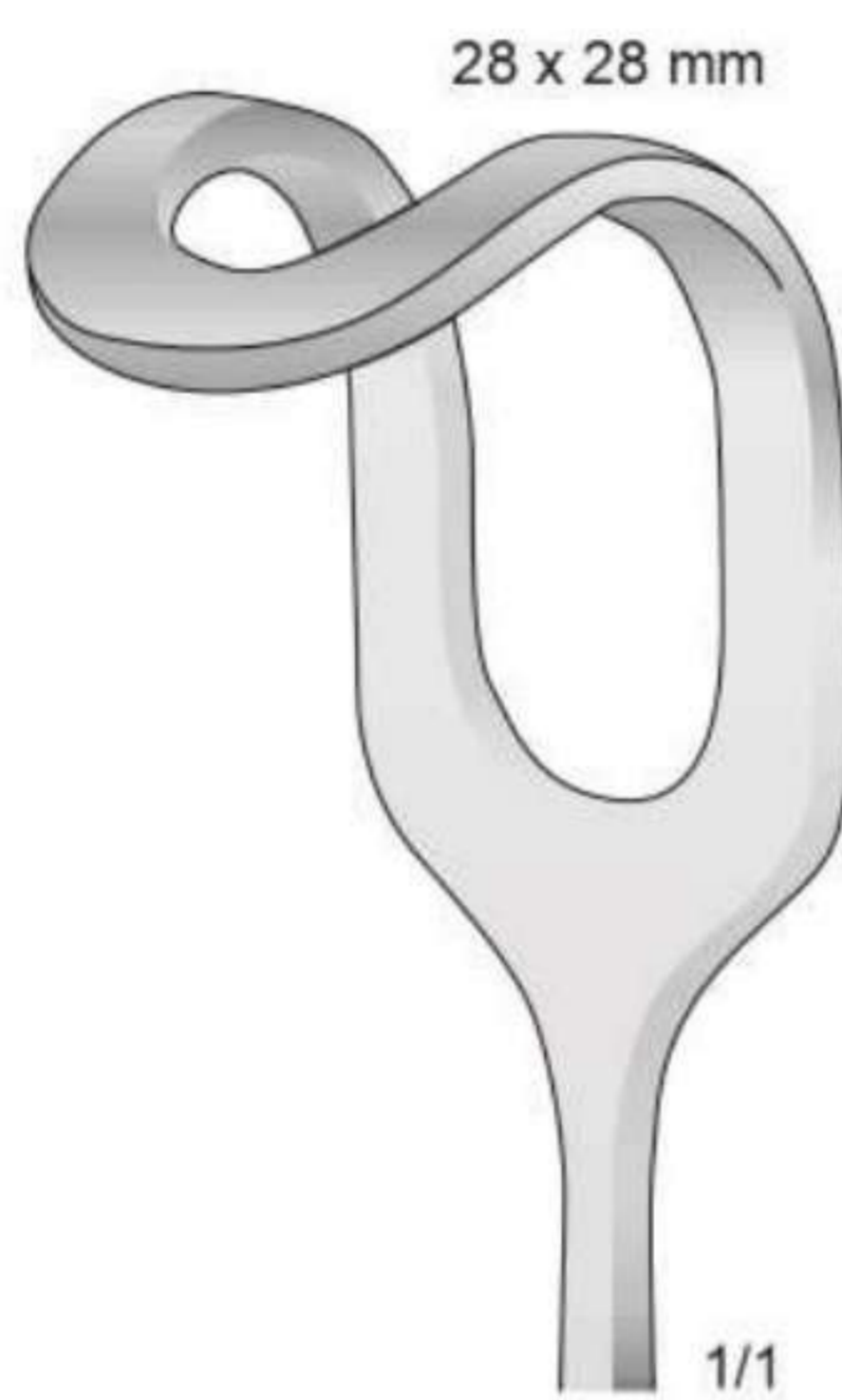

BT-82
225 mm

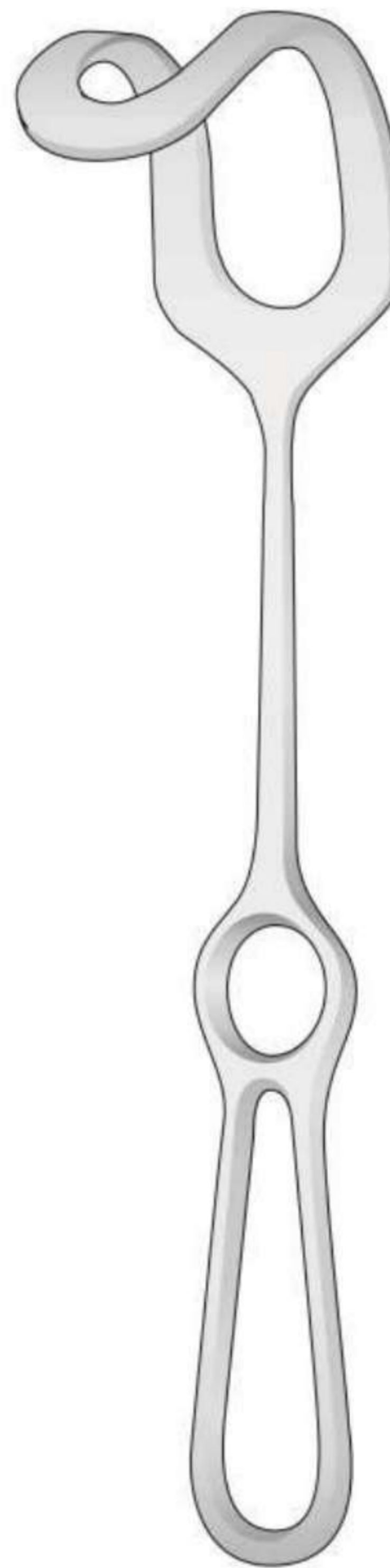

MIDDELDORPF
BT-180/BT-182
255 mm

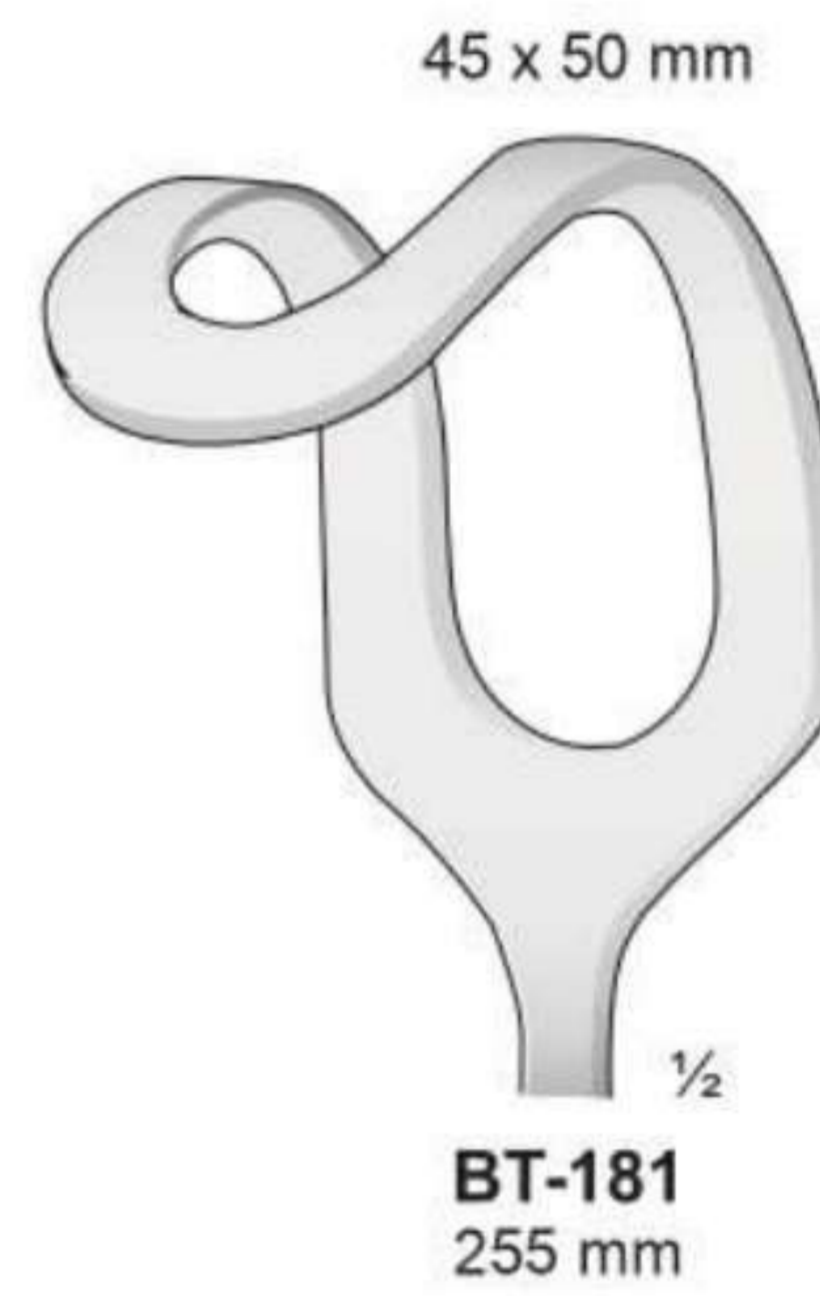

BT-181
255 mm



BT-182
255 mm

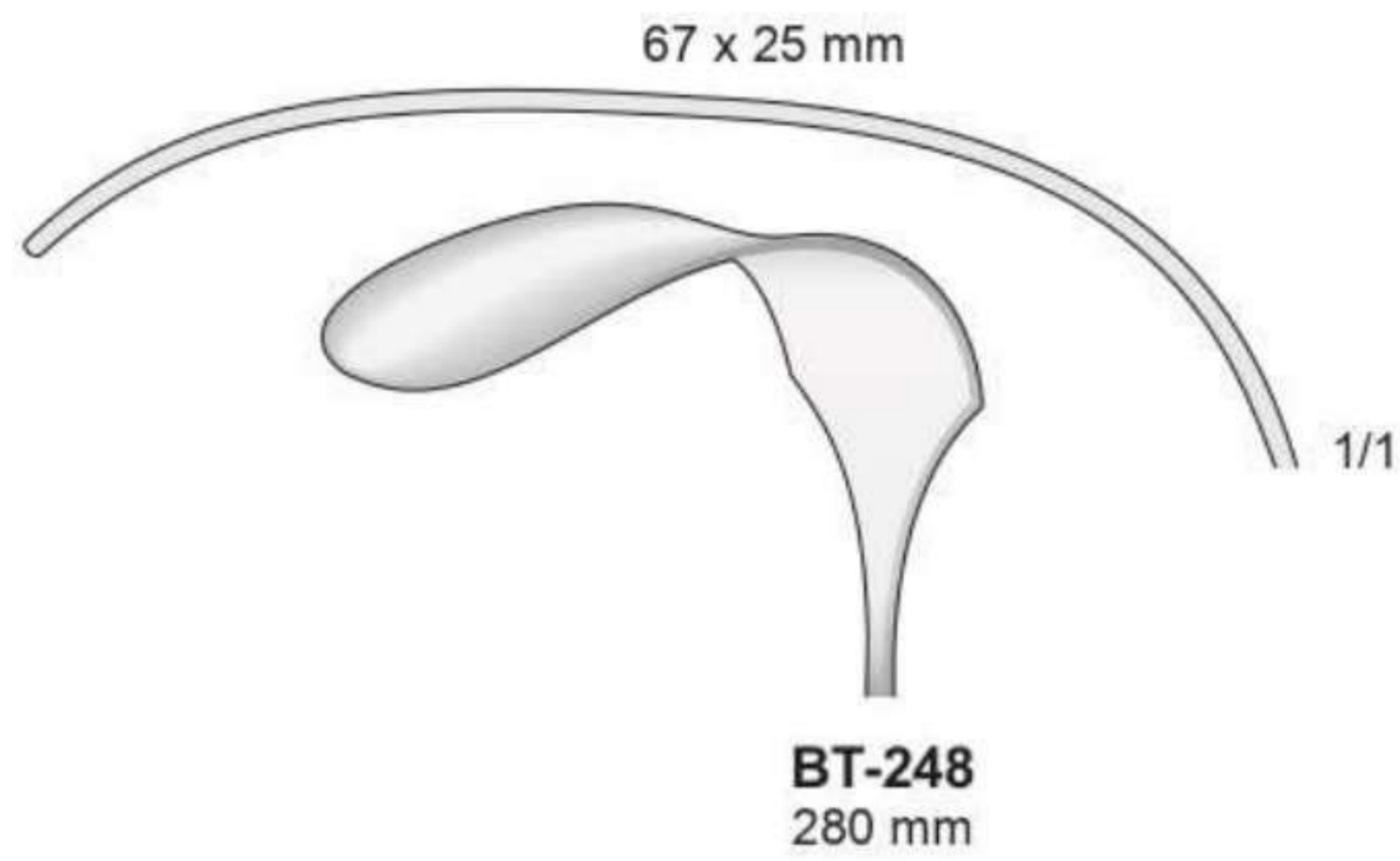
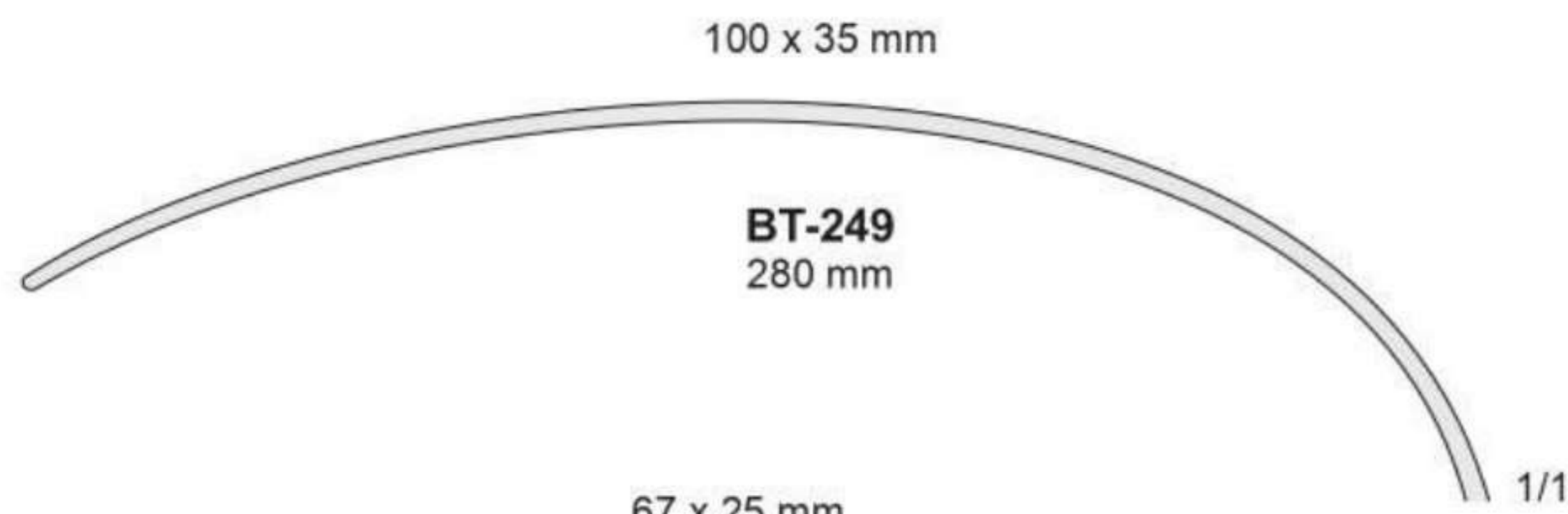

BT-270 80x42 mm
BT-271 80x50 mm
BT-272 80x60 mm

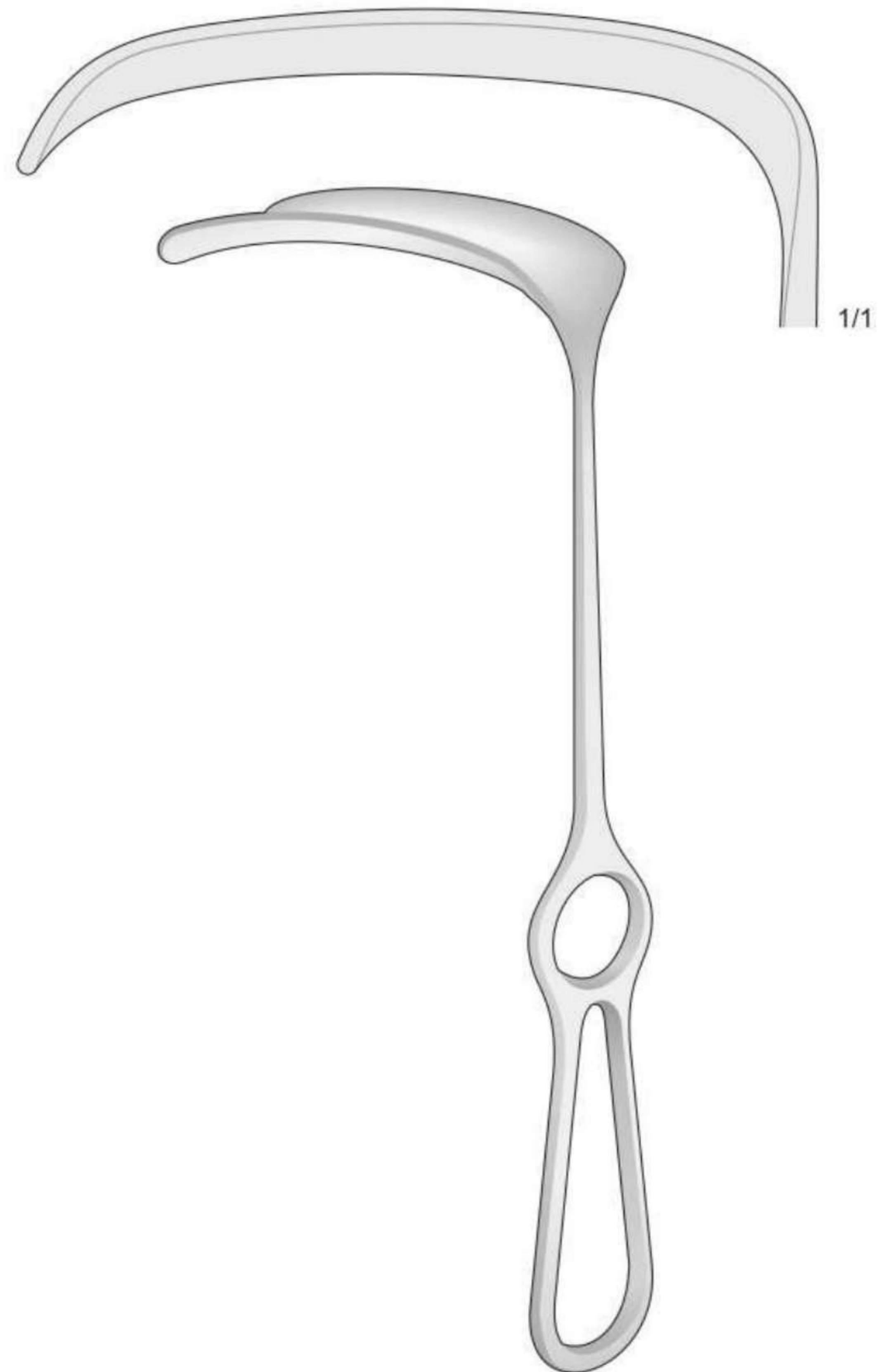
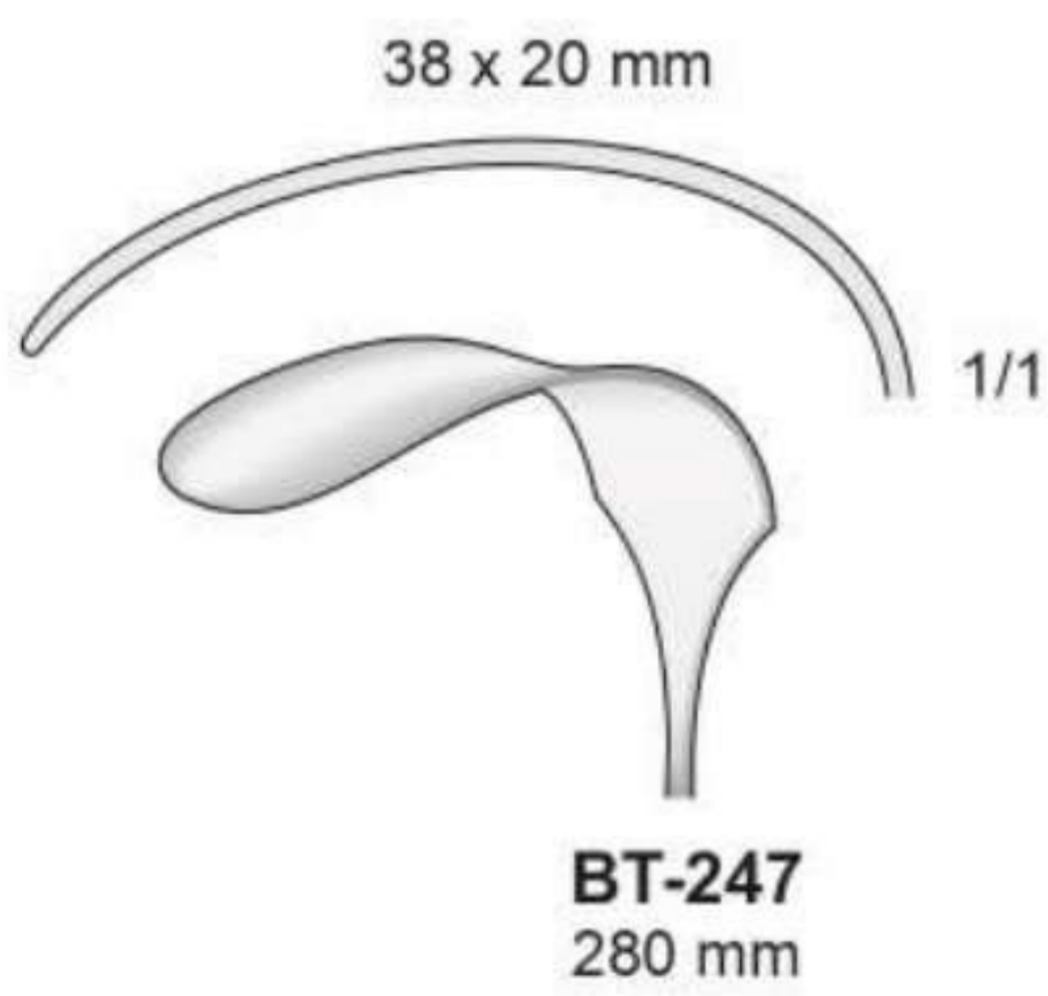
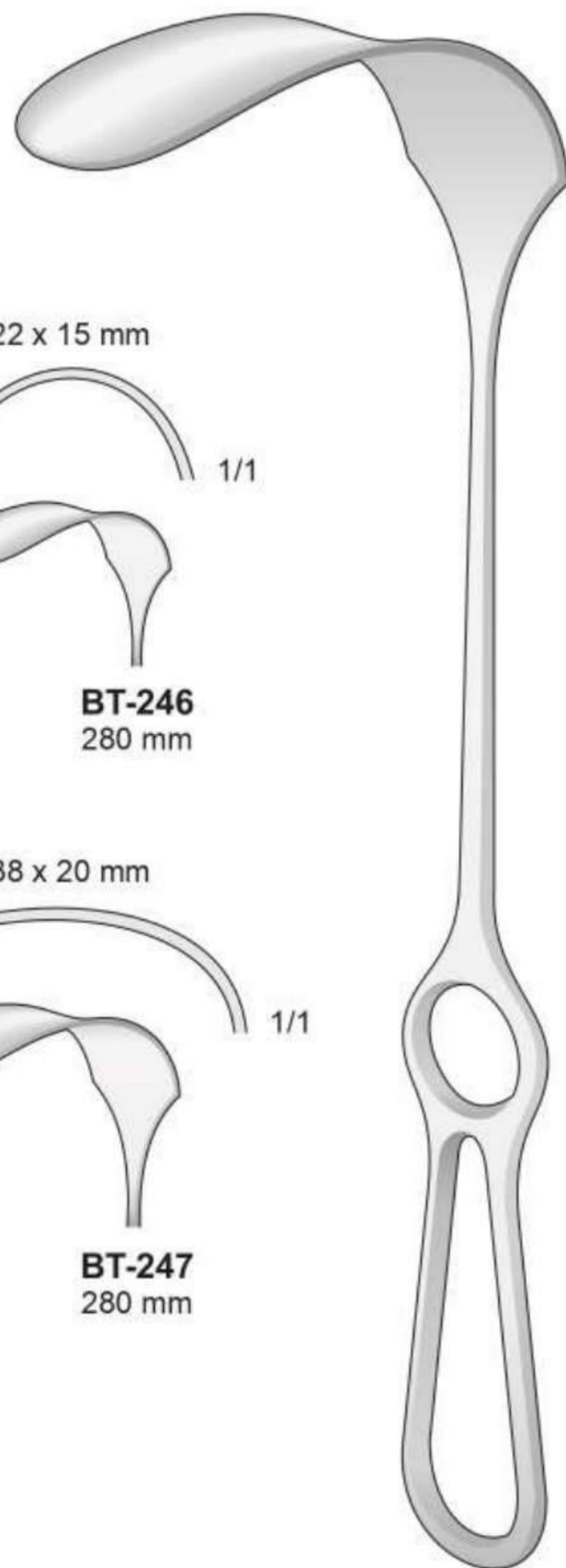

KOCHER
BT-246/BT-249
280 mm

KOCHER
BT-270/BT-272
250 mm

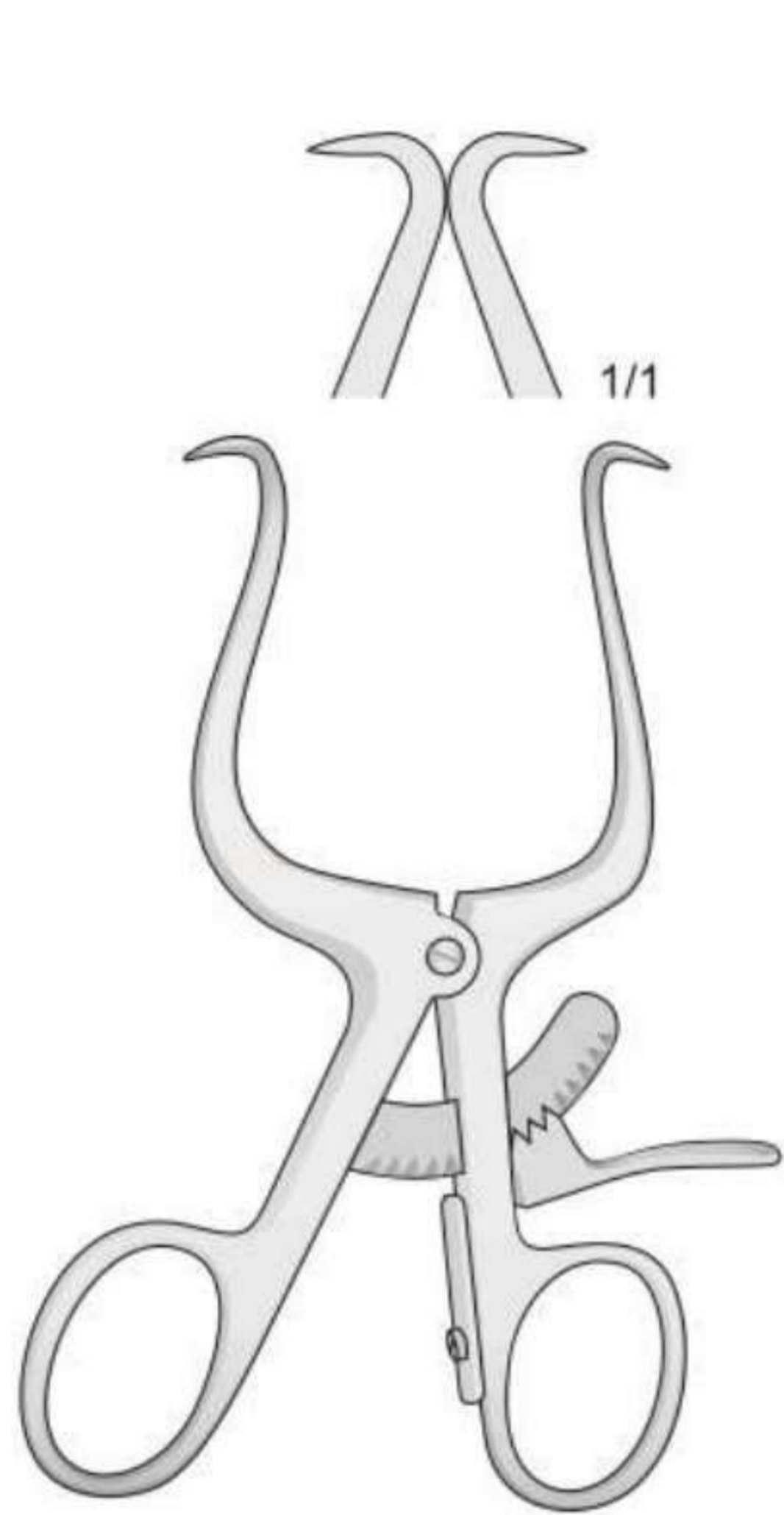

GELPI
BV-14
90 mm

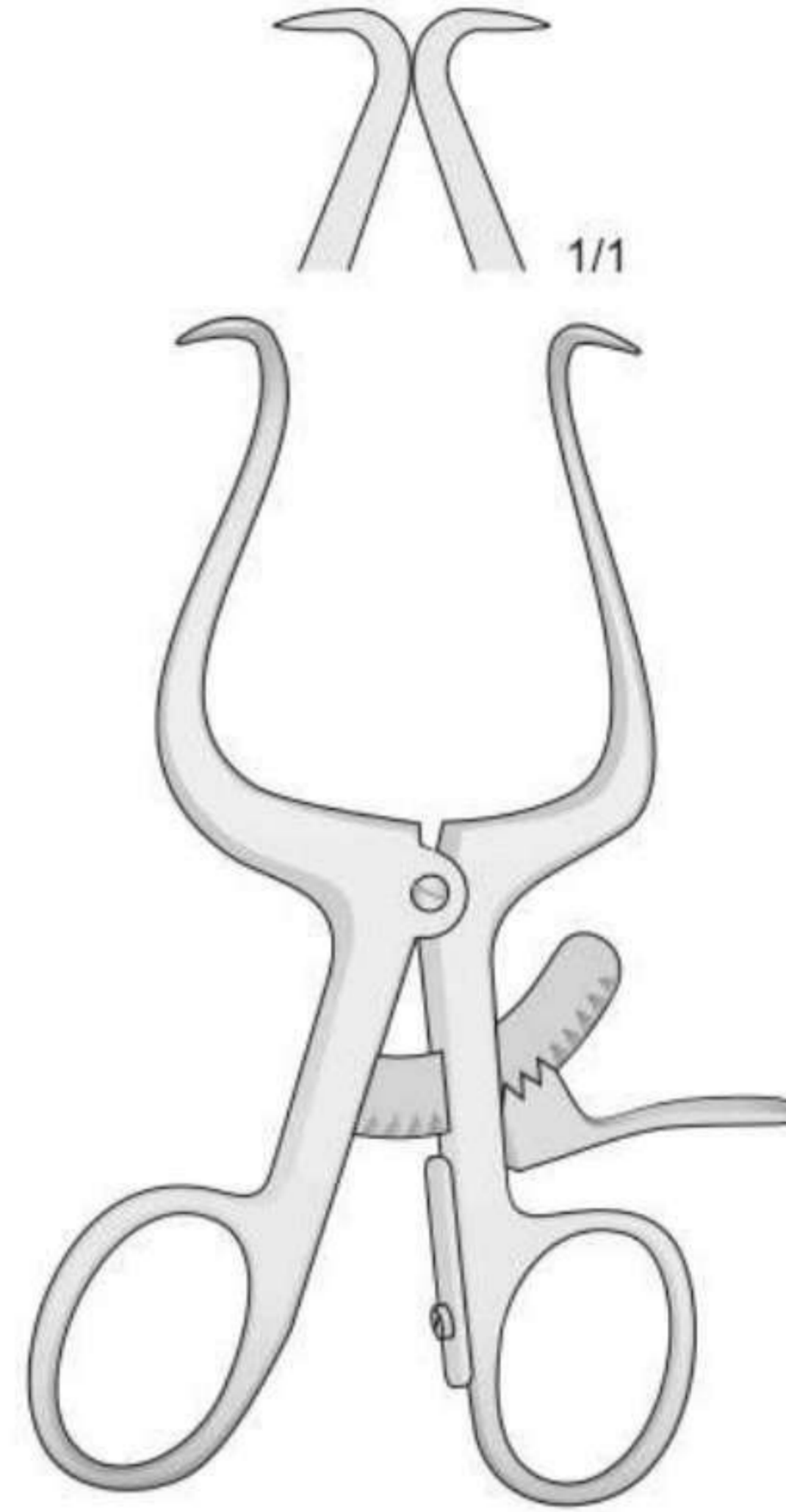

GELPI
BV-15
110 mm



GELPI
BV-16
140 mm

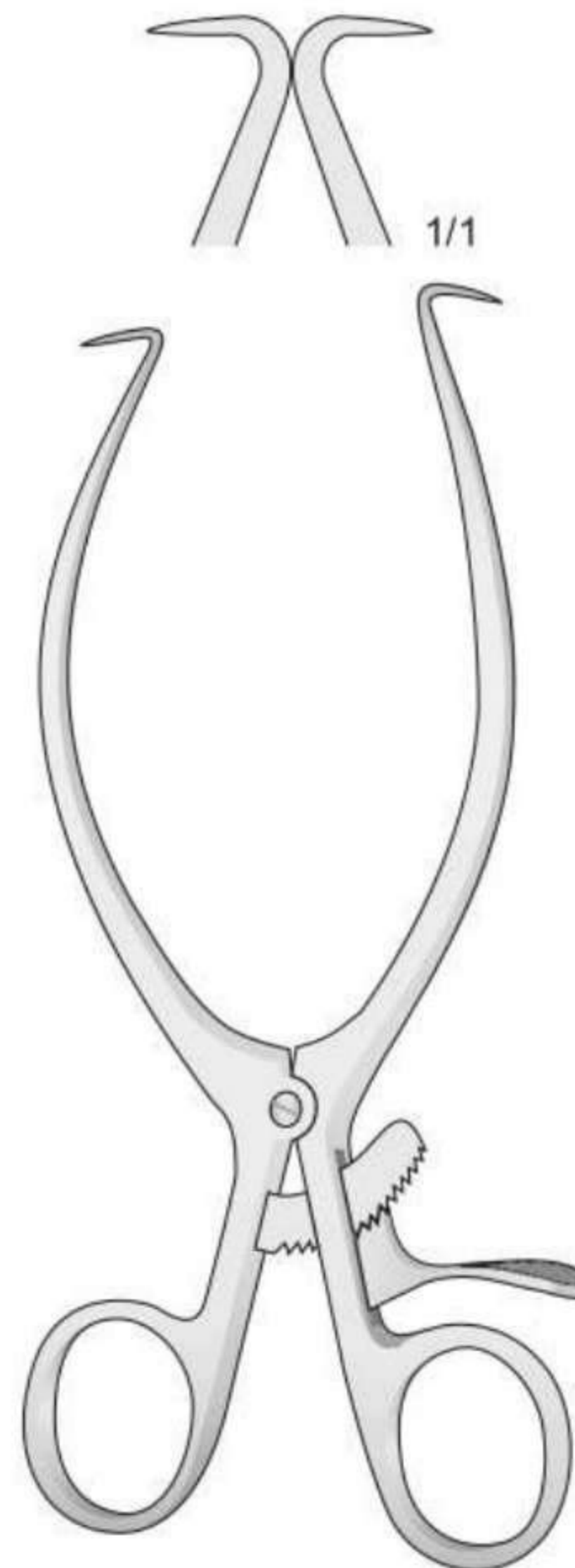

GELPI
BV-17
180 mm

Wundspreizer

Self retaining retractors

Divaricatori

Separadores

Écarteurs

Femur-Wundspreizer für kinder
Femur Retractor for children
Divaricatore femorale per bambini

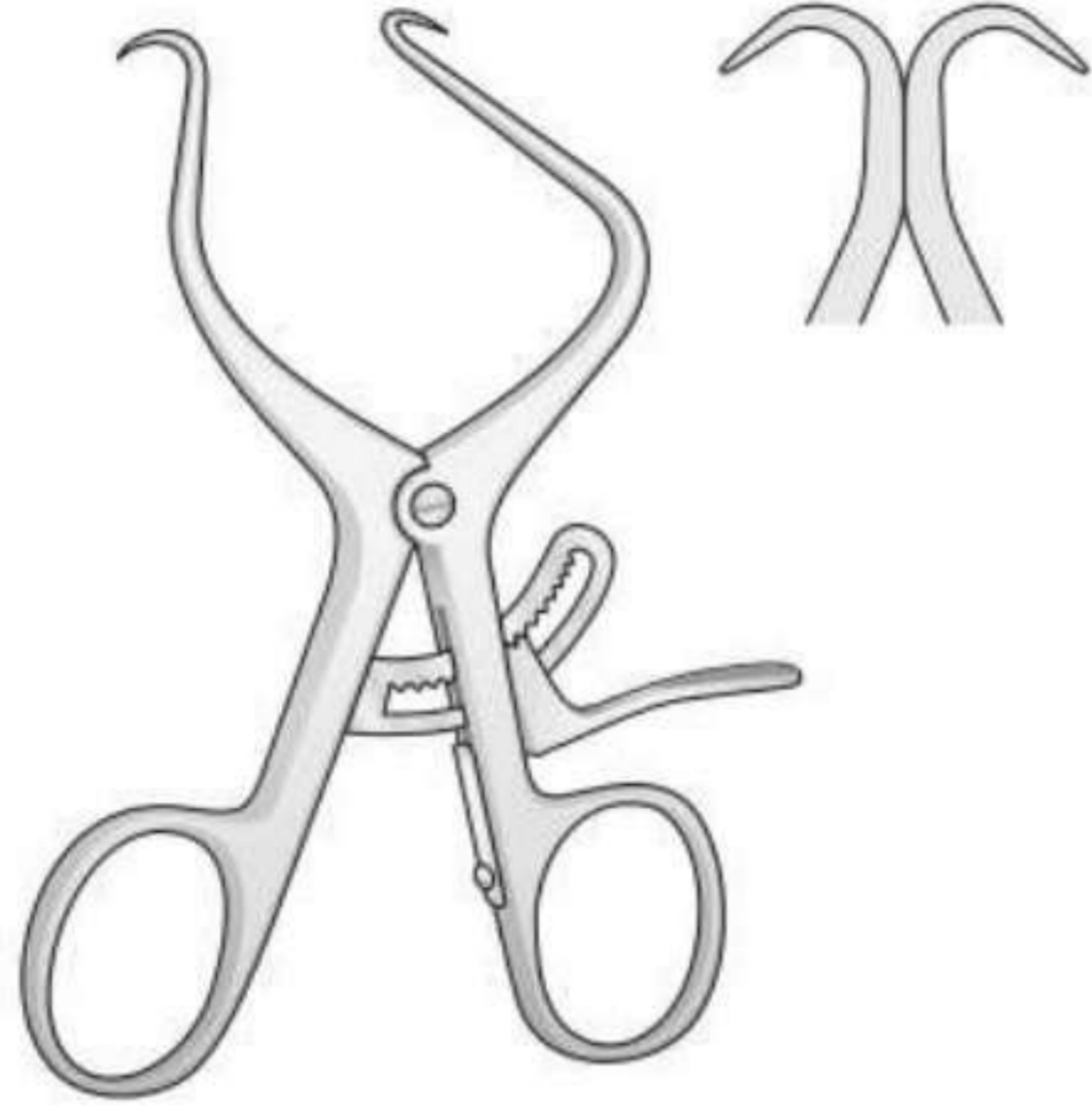

DE BAKEY
BV-315
100 mm

Femur-Wundspreizer
Femur Retractor
Divaricatore femorale

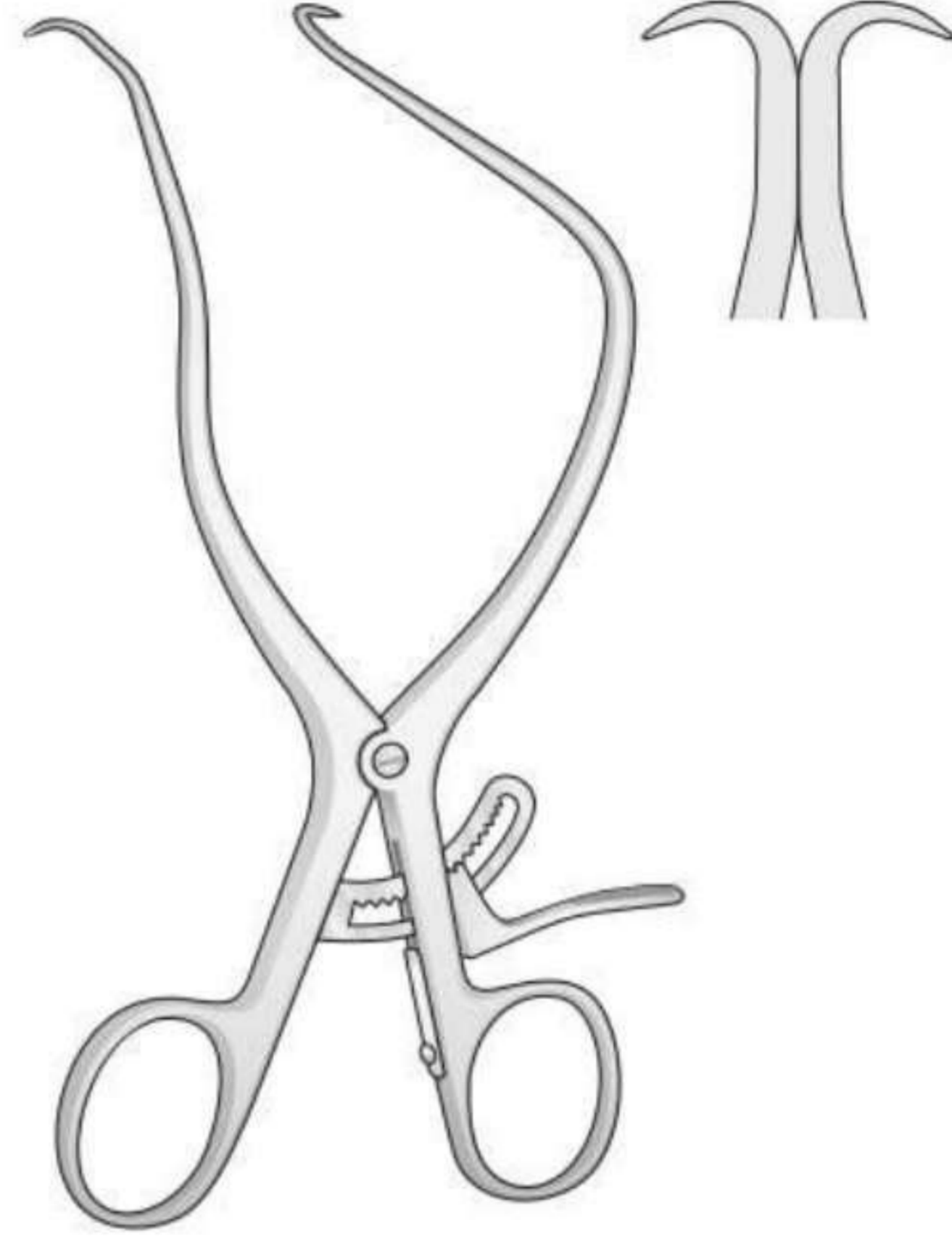

DE BAKEY
BV-316
170 mm

Wundspreizer
Retractors for shoulder
Divaricatori da spalla
Separadores
Écarteurs

Stumpf - Blunt
Smusso - Romo
Mousse

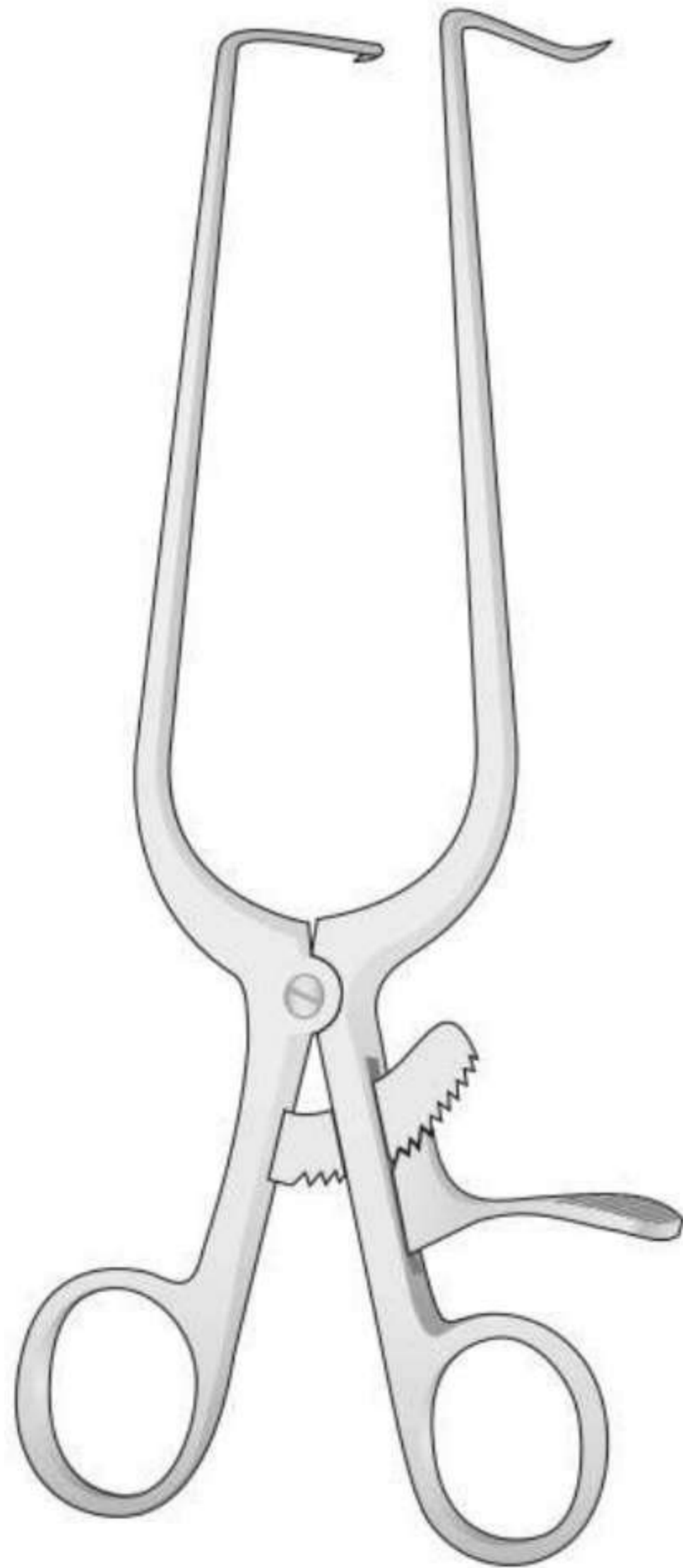

BV-100
215 mm

Stumpf - Blunt
Smusso - Romo
Mousse

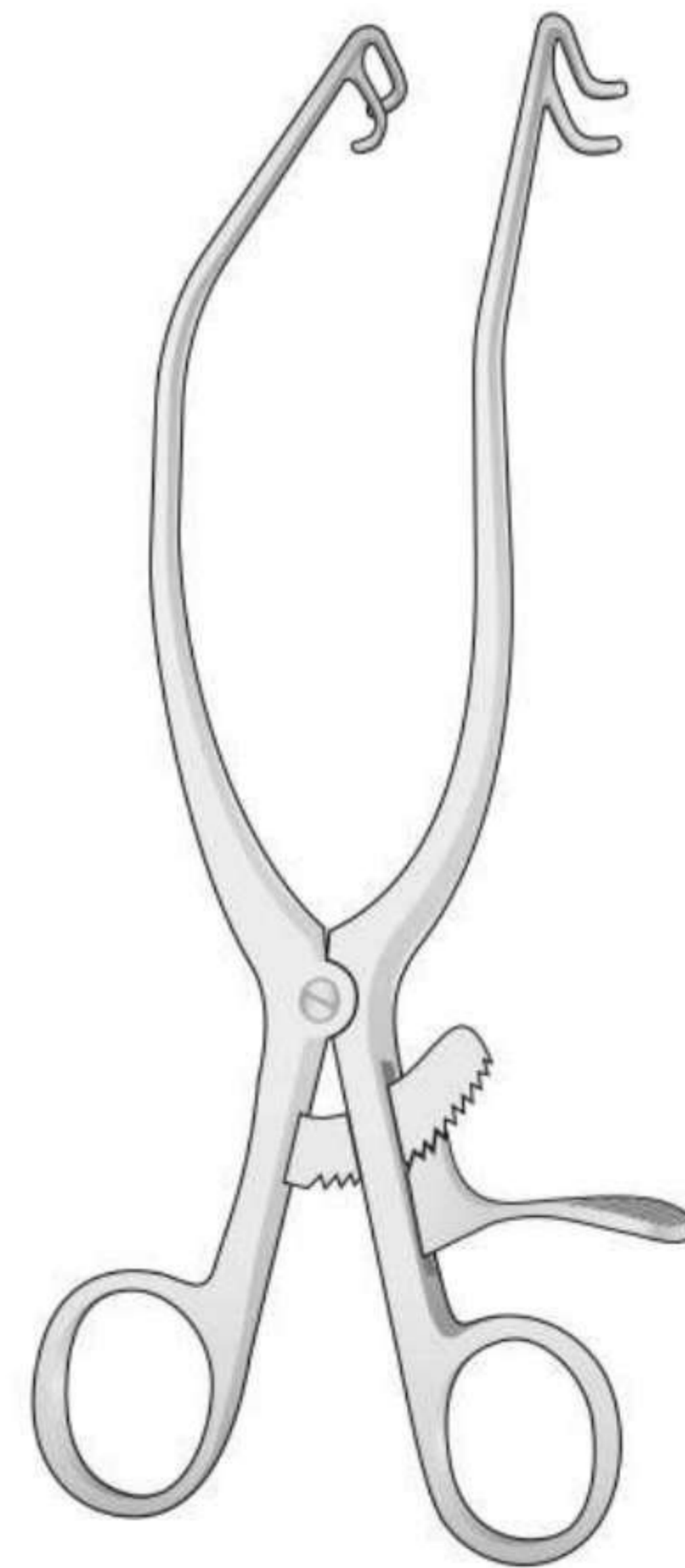

KÖLBEL
BV-103
180 mm

40 mm

1/1

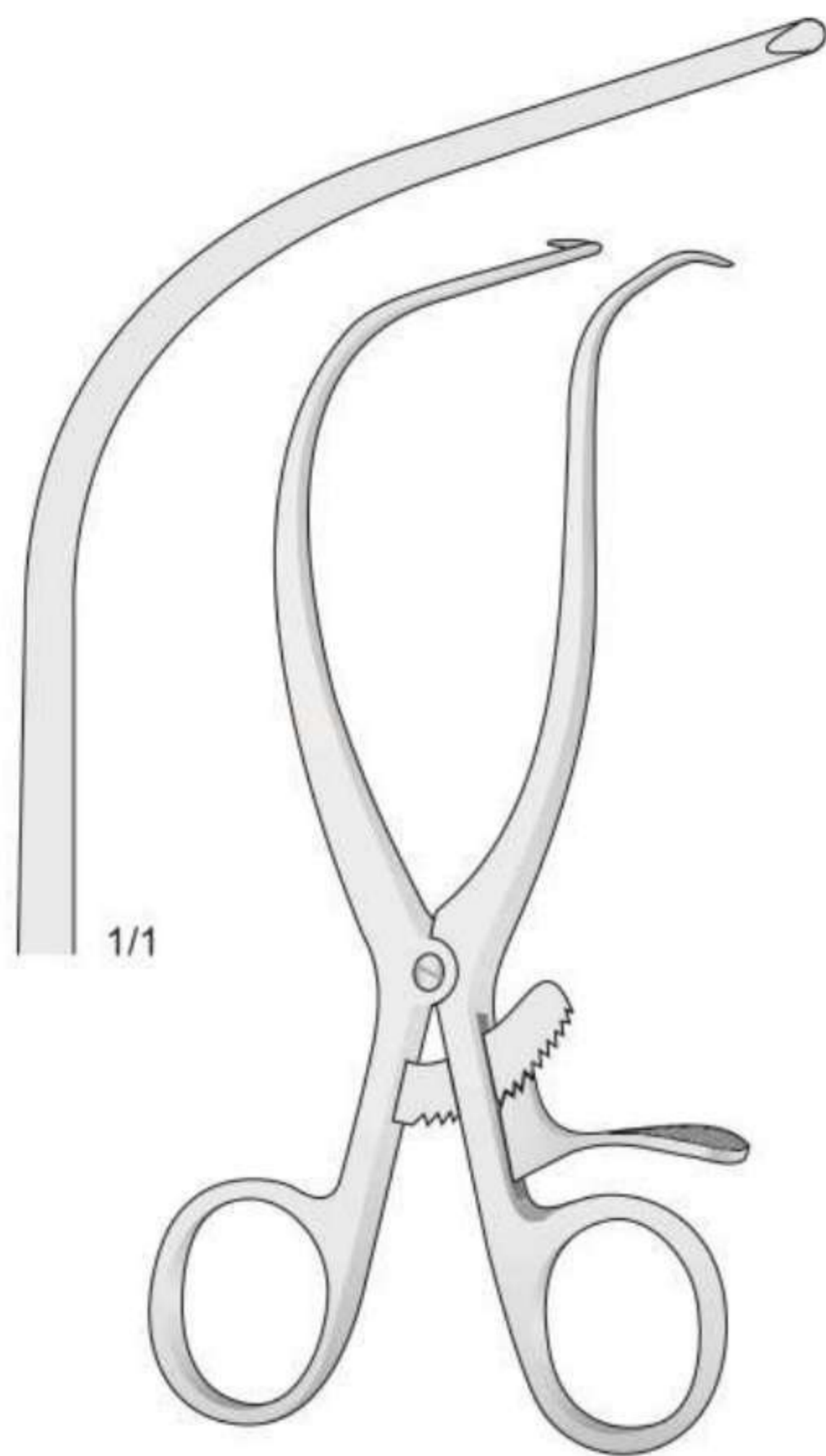

GELPI-SELETZ
BV-11
 165 mm

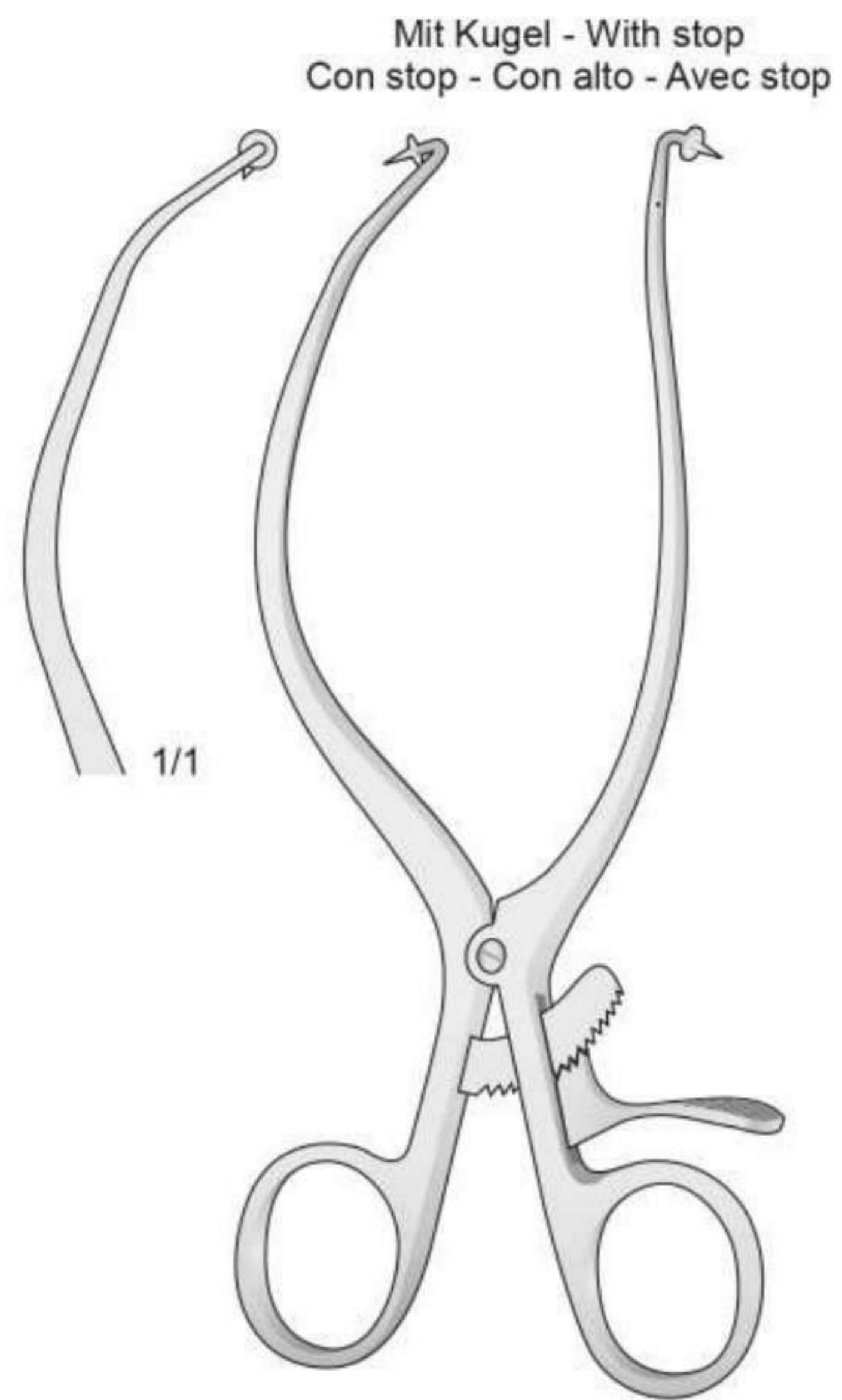

GELPI-LOKTITE
BV-13
 190 mm

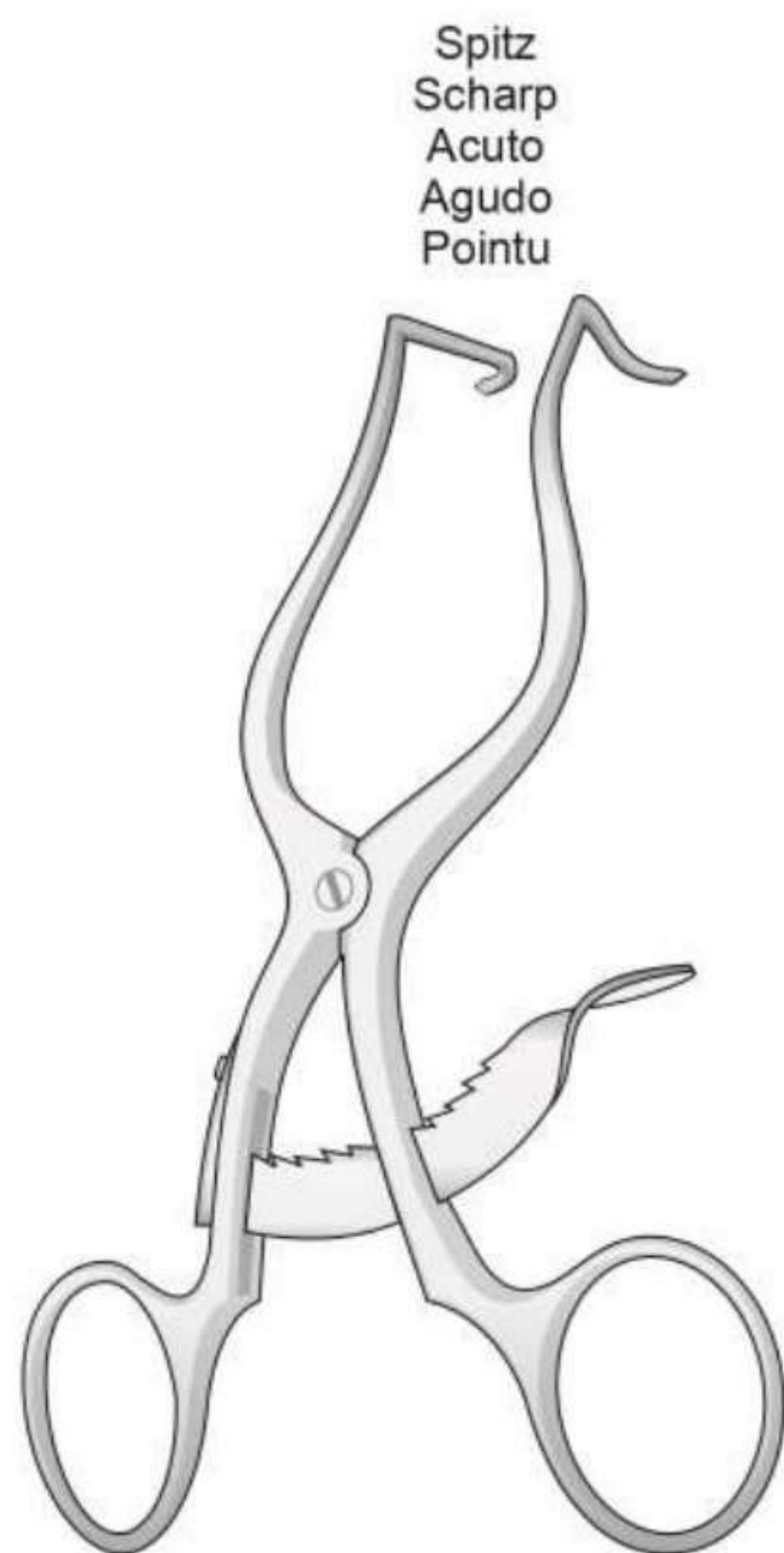

CLOWARD-CONTOUR
BV-108
 140 mm

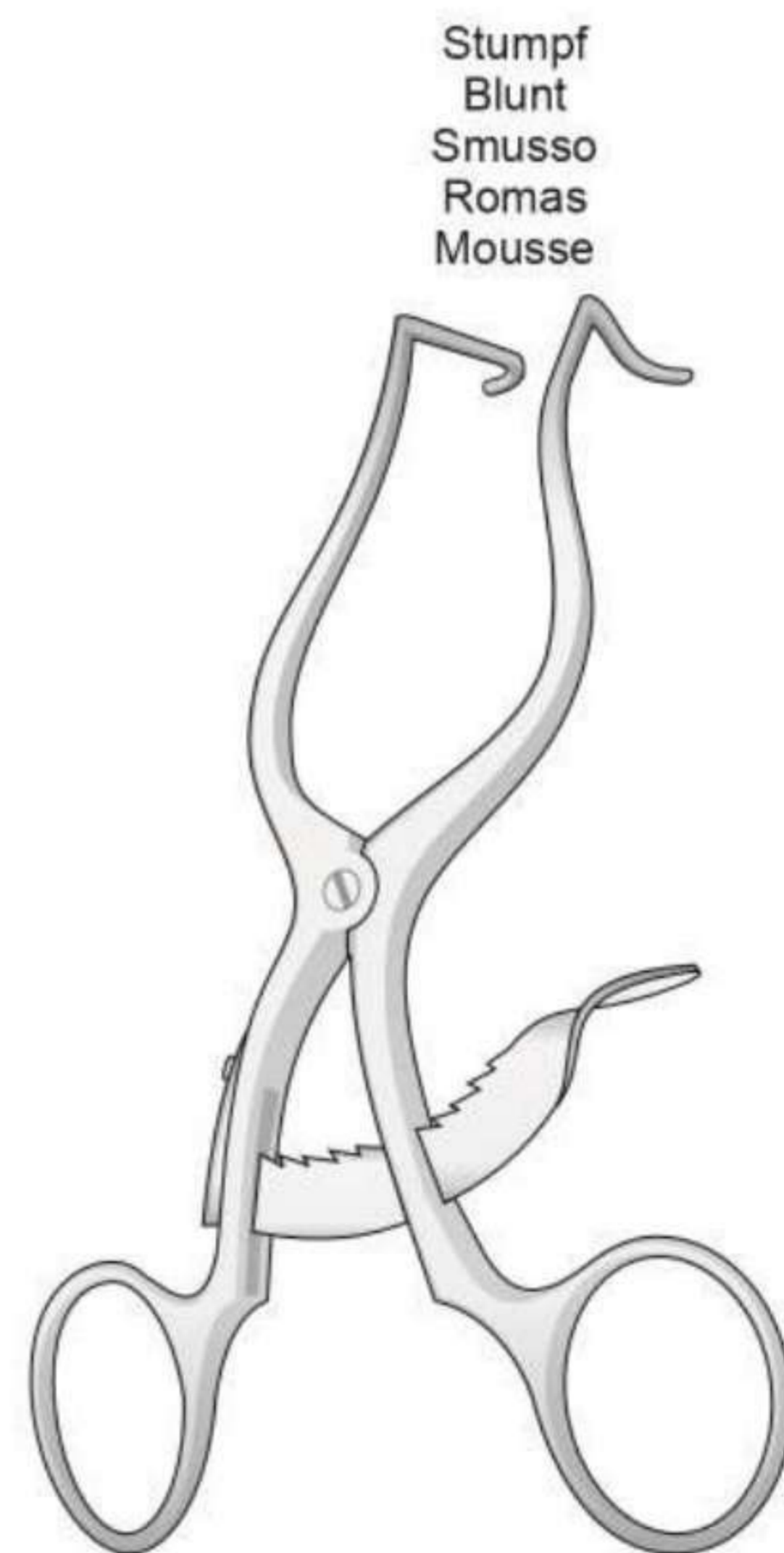

CLOWARD-CONTOUR
BV-109
 140 mm

Wundspreizer

Self retaining retractors

Divaricatori

Separadores

Écarteurs

Spitz
Scharp
Acuto
Agudo
Pointu

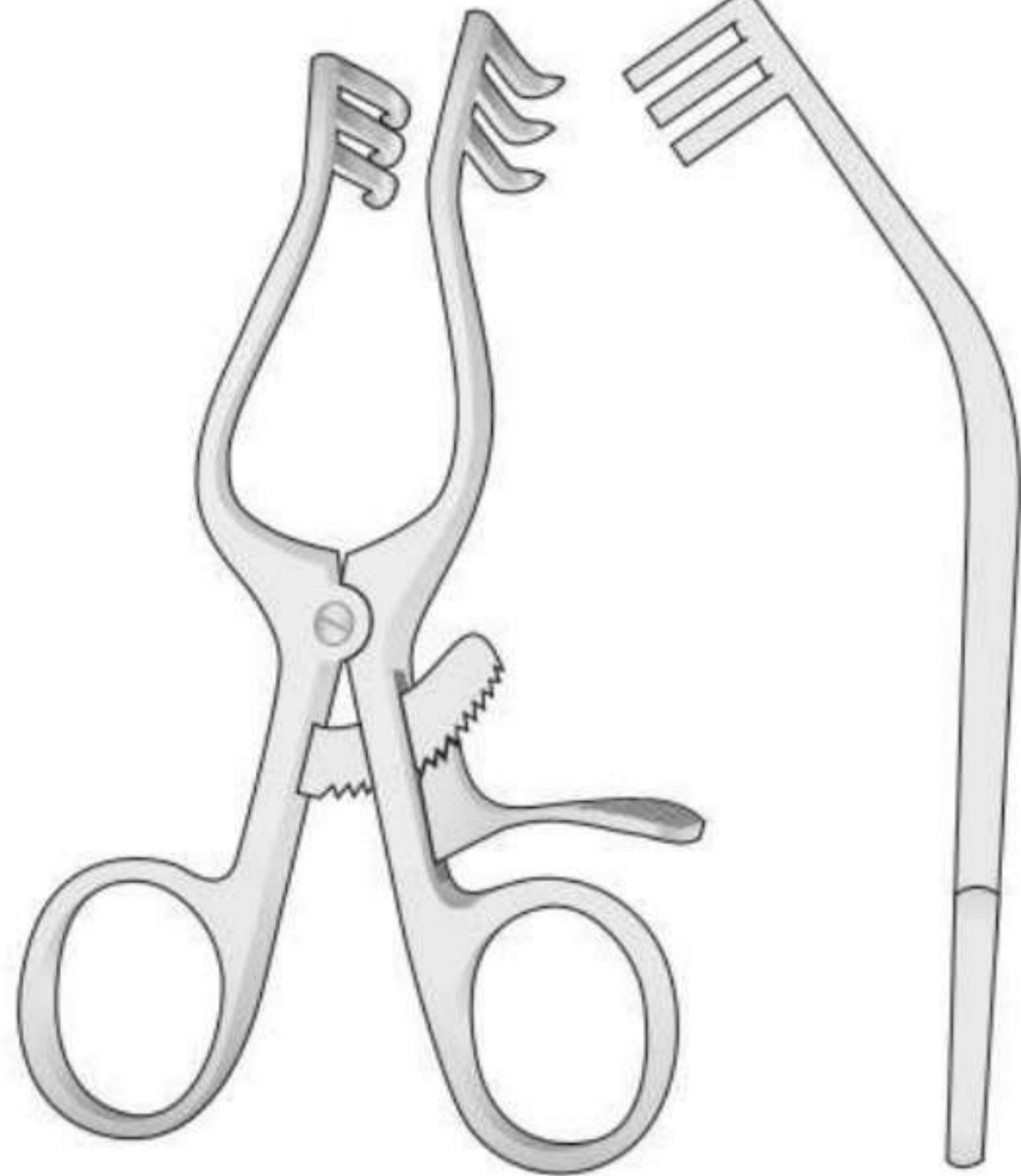

WULLSTEIN
BV-111
105 mm

Stumpf
Blunt
Smusso
Romas
Mousse

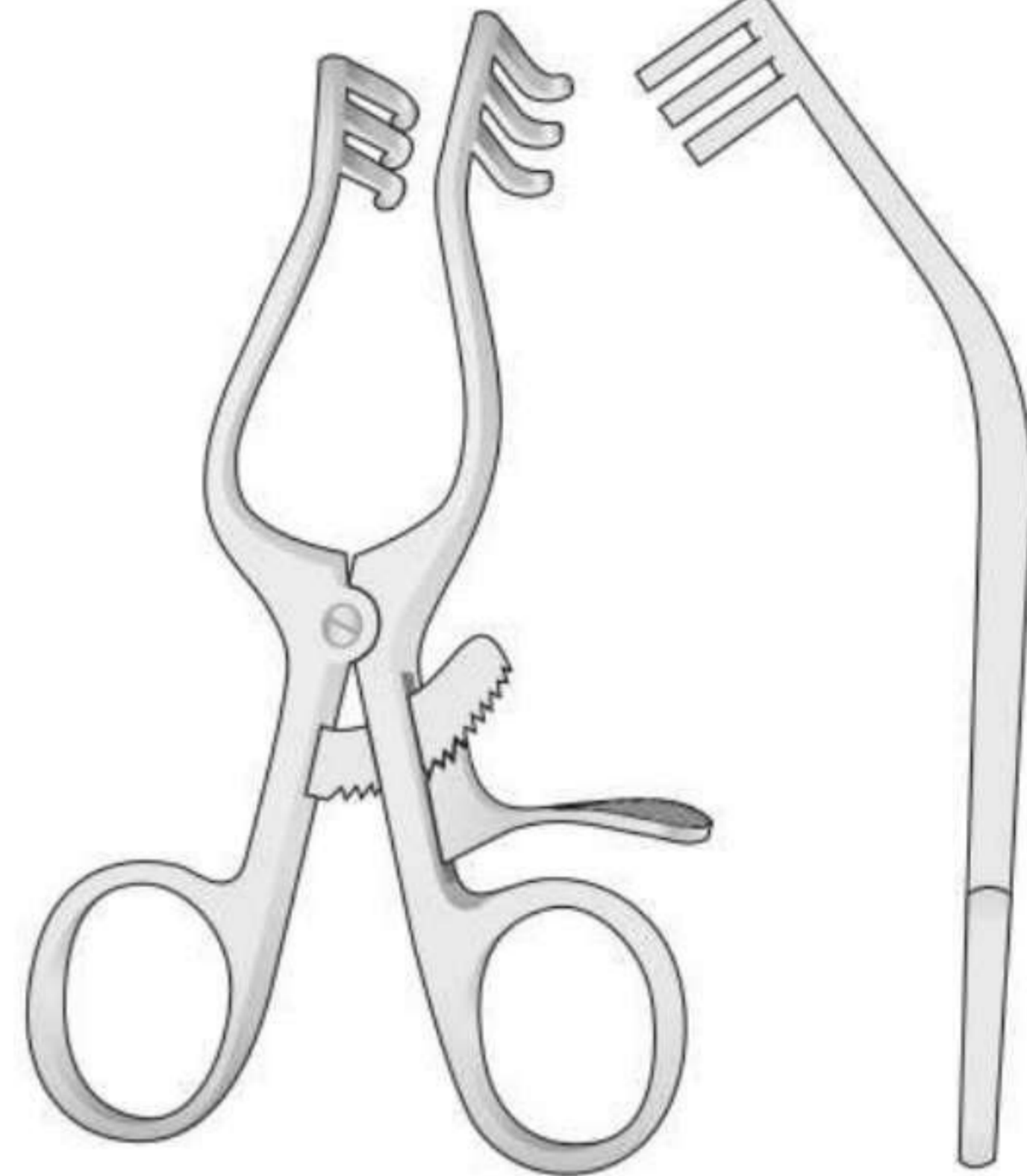

WULLSTEIN
BV-112
105 mm

Spitz
Scharp
Acuto
Agudo
Pointu

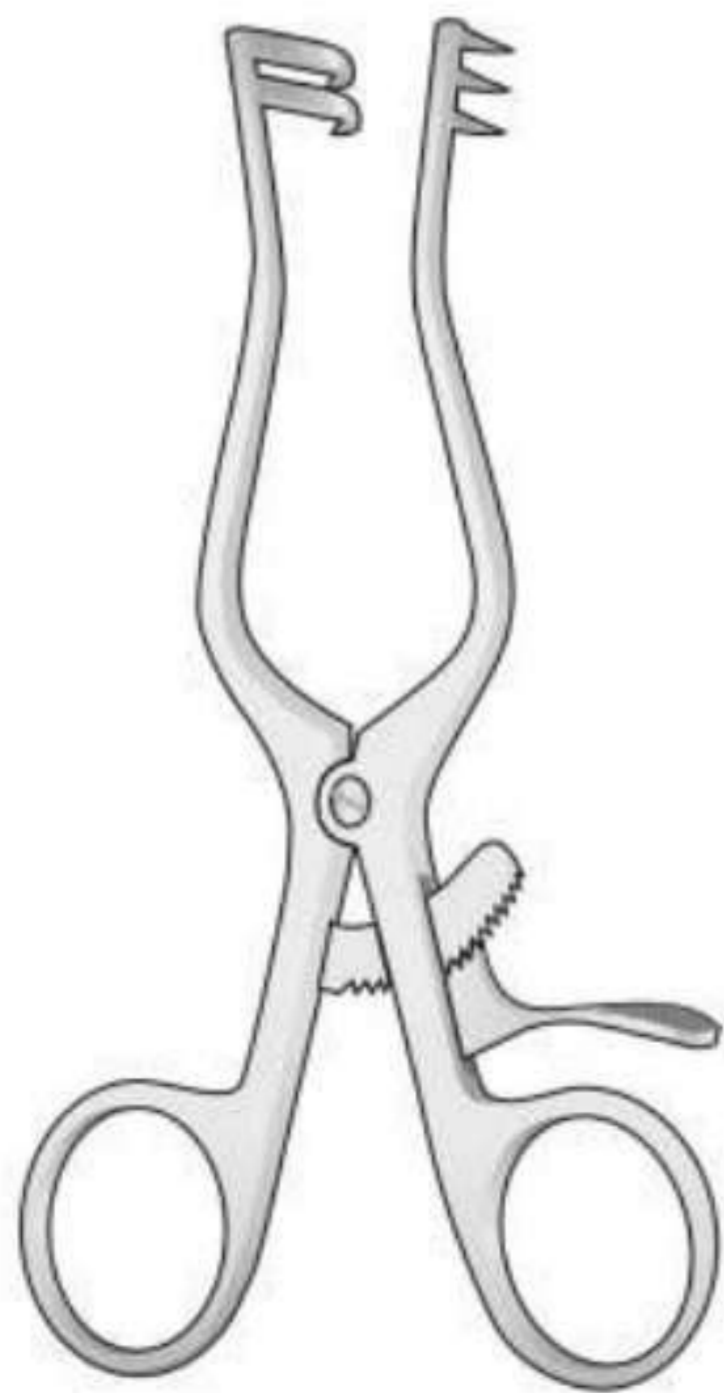

WEITLANER
BV-07
110 mm

Stumpf
Blunt
Smusso
Romas
Mousse

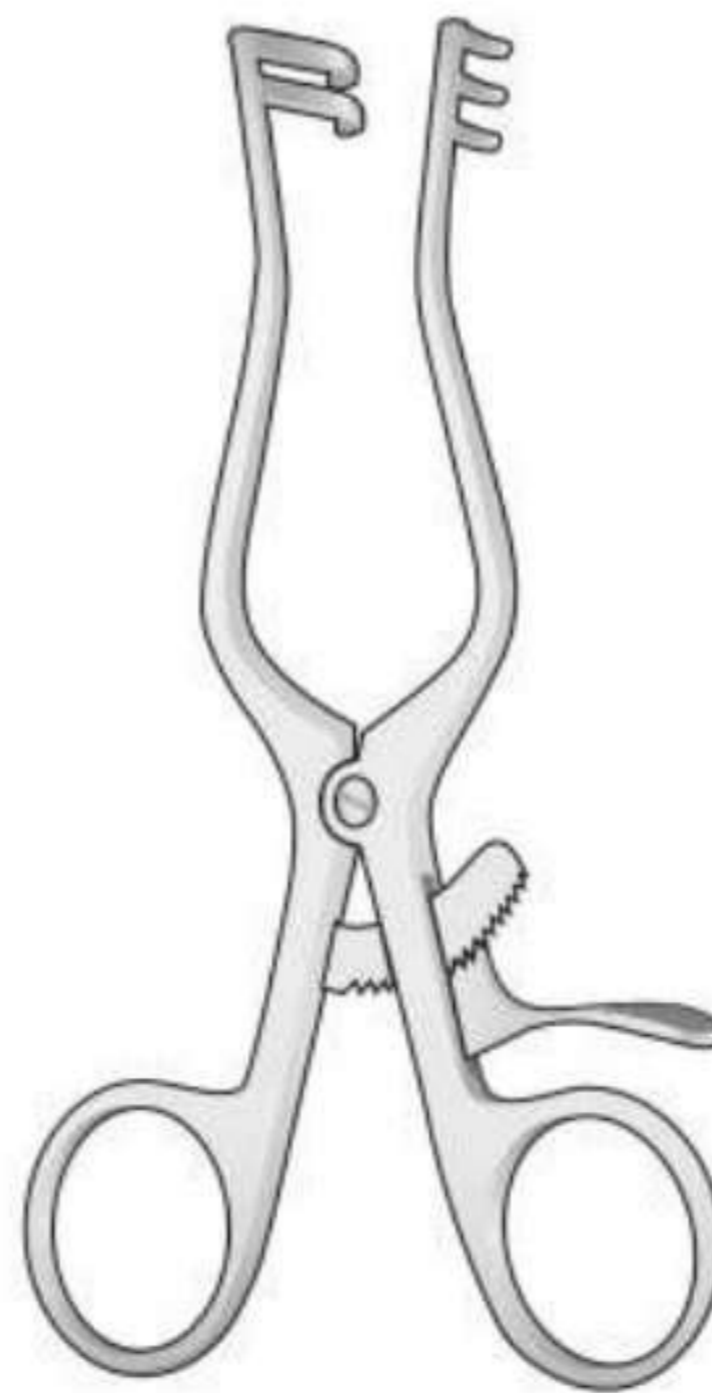

WEITLANER
BV-09
110 mm

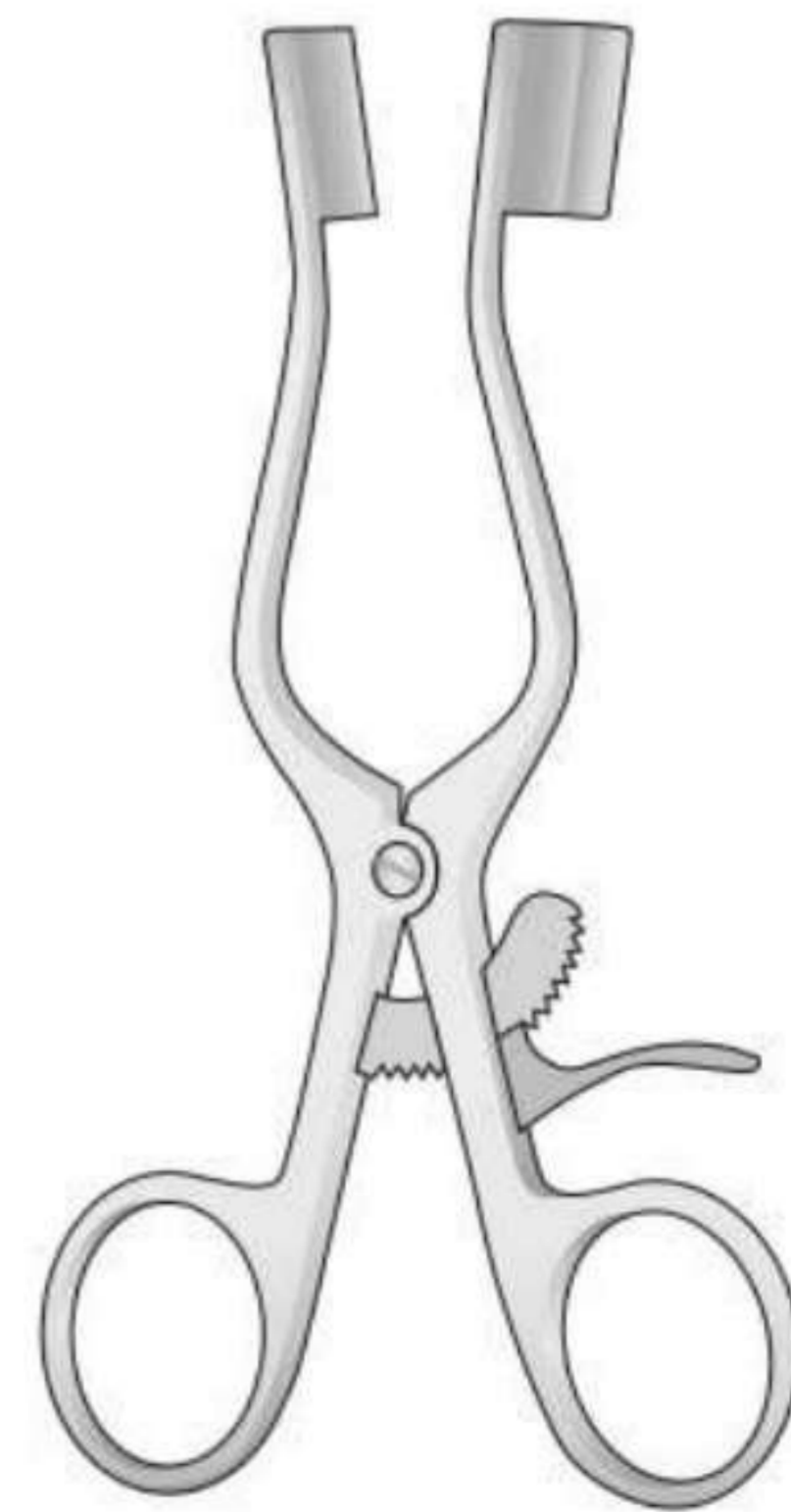

BABY-WEITLANER
BV-26
140 mm

WEITLANER
BV-55
135 mm

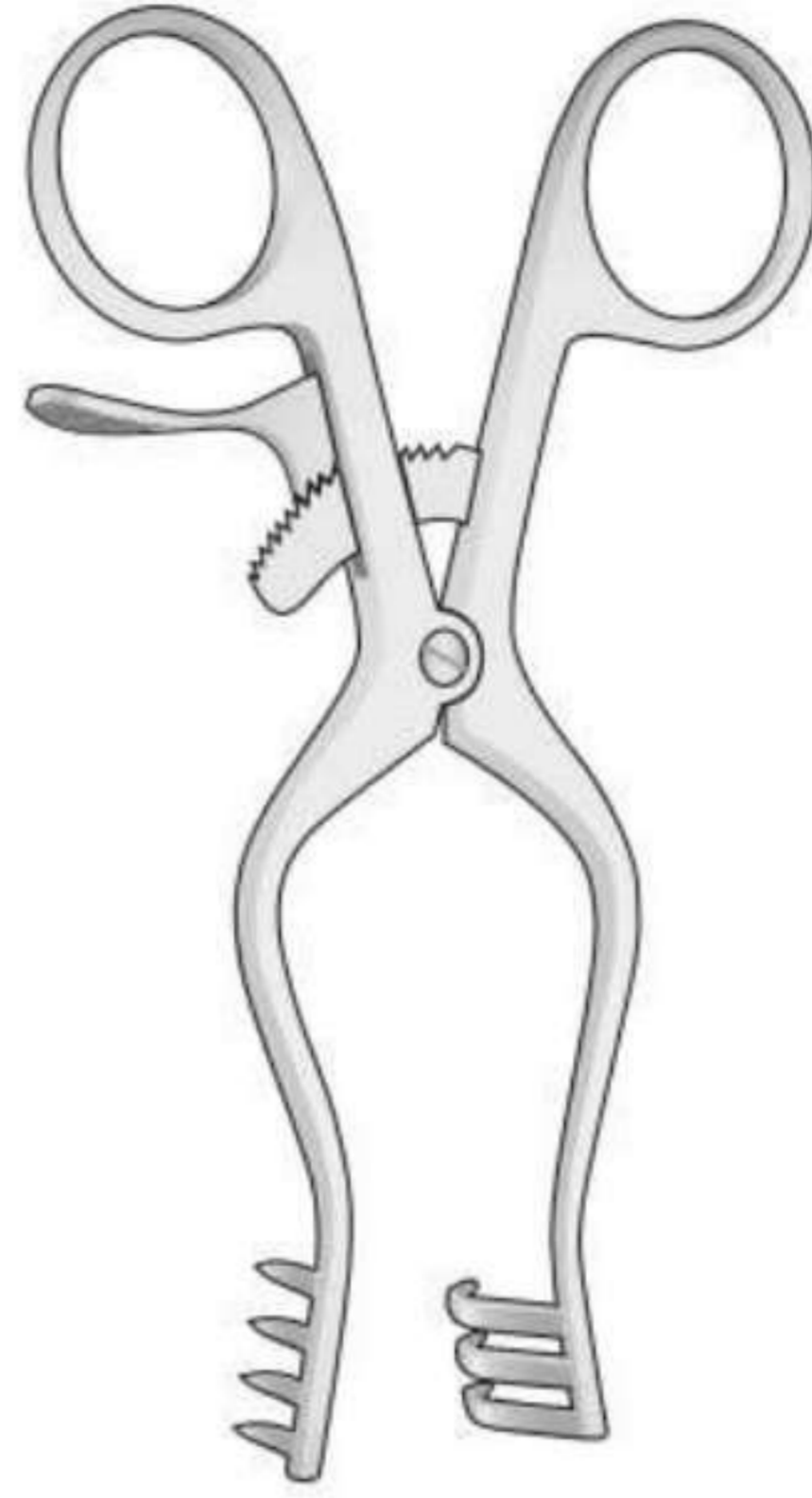

Spitz - Sharp - Acuto
Agudas - Pointu

WEITLANER
BV-56
135 mm

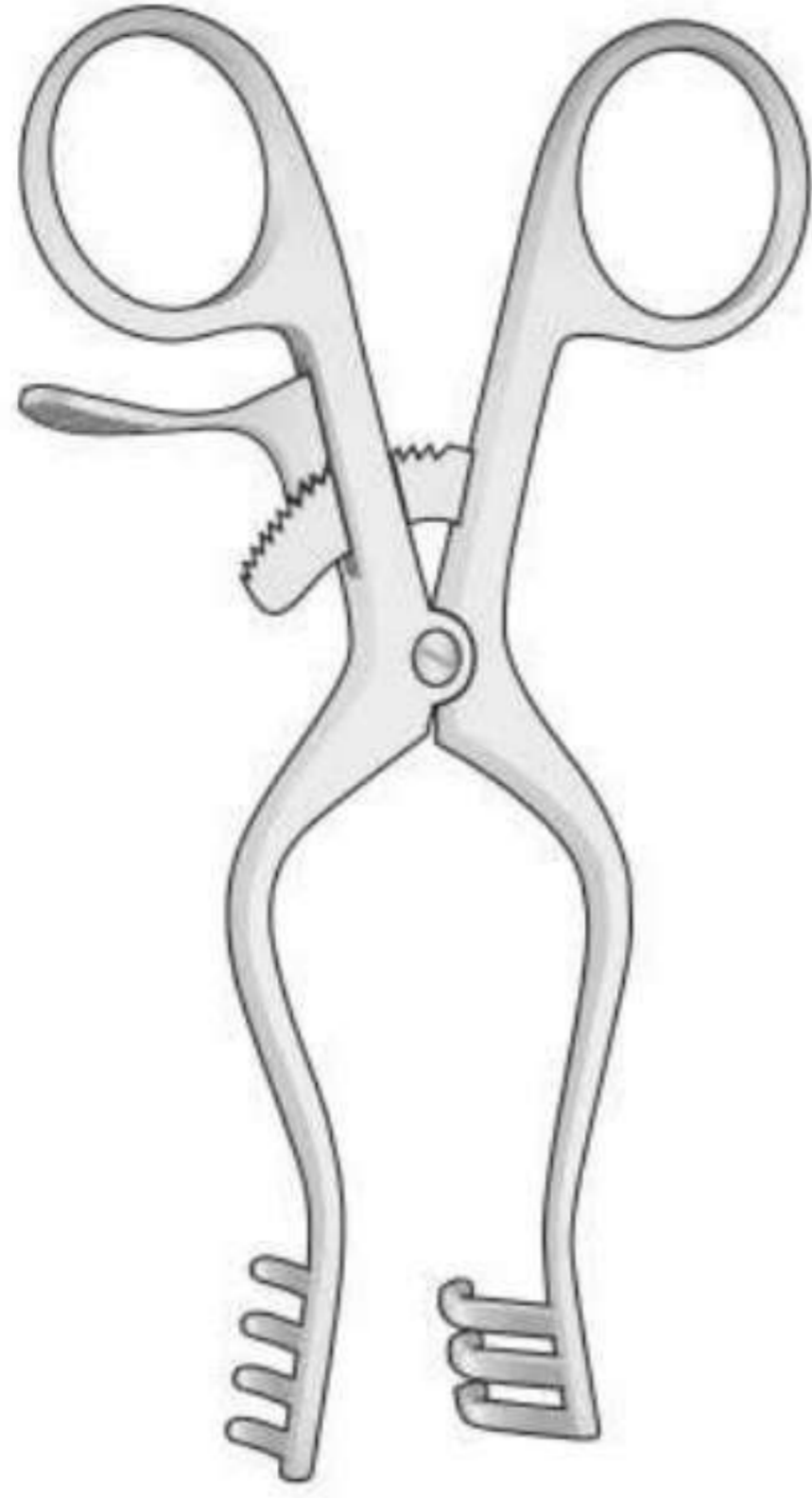

Stumpf - Blunt - Smusso
Romas - Mousse

WEITLANER
BV-18
135 mm

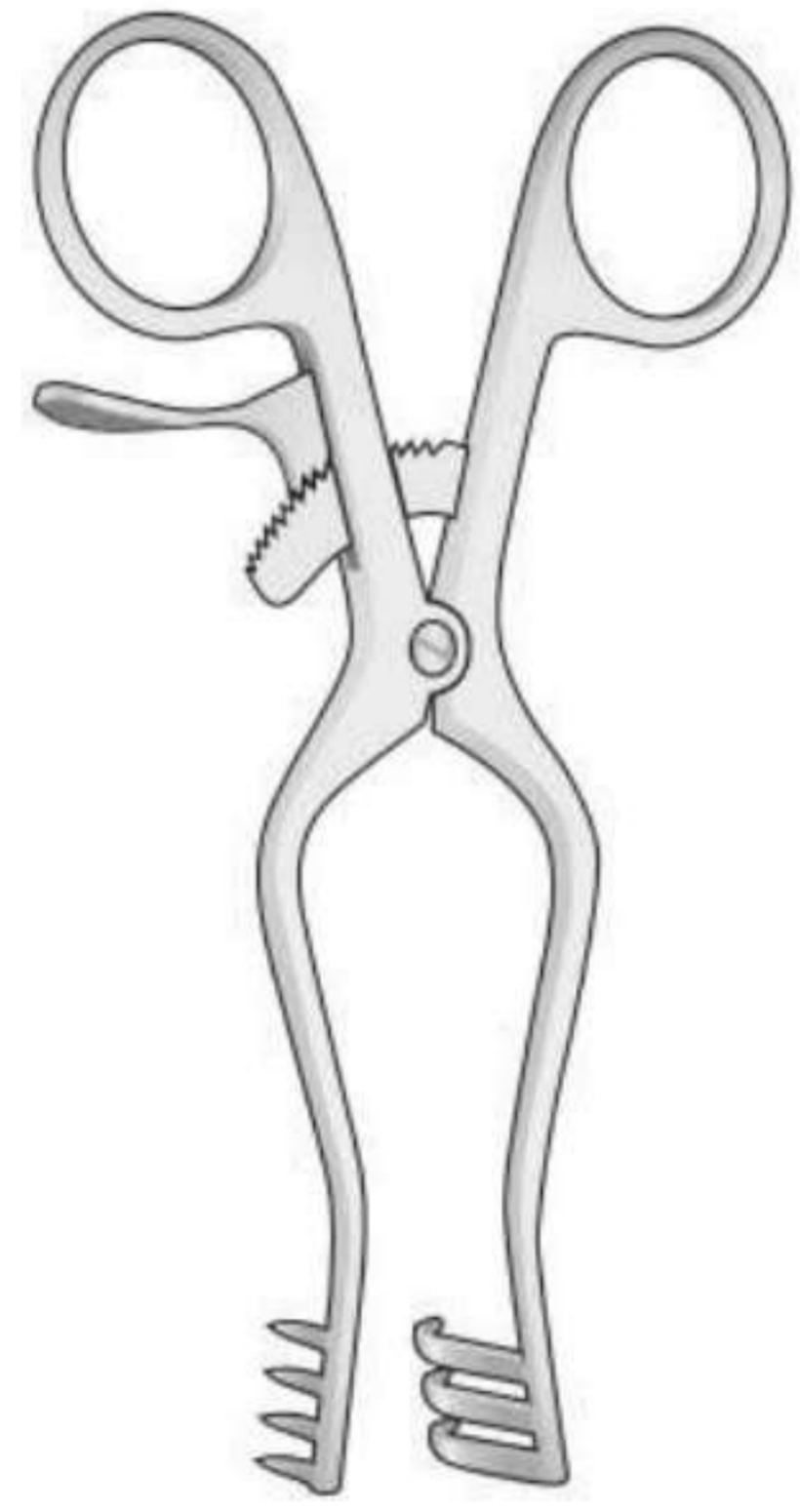

Halbscharf - Semi Sharp - Semi acuto
Semi Agudas - Semi Pointu

WEITLANER
BV-20
135 mm

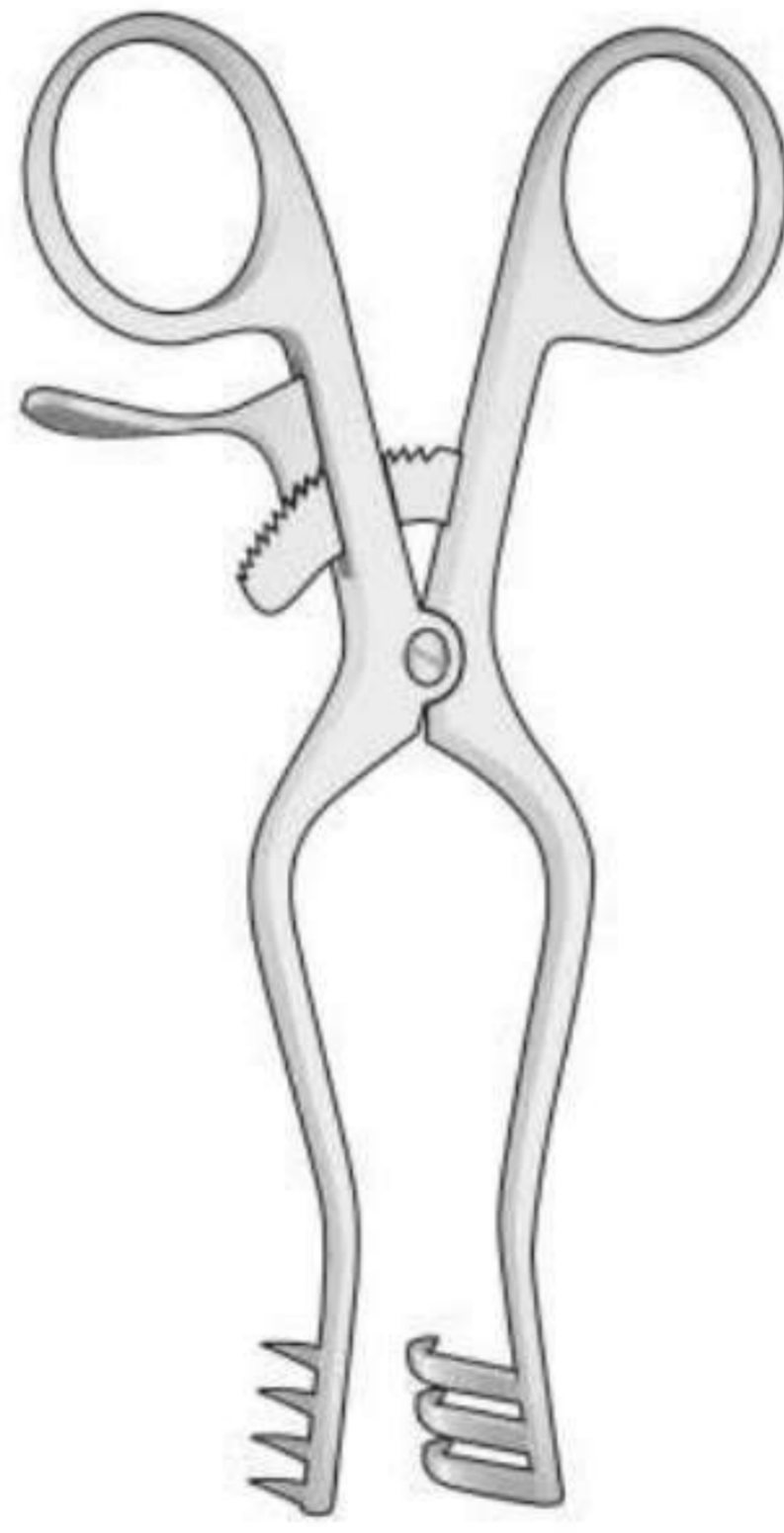

Spitz - Sharp - Acuto
Agudas - Pointu

WEITLANER
BV-22
135 mm

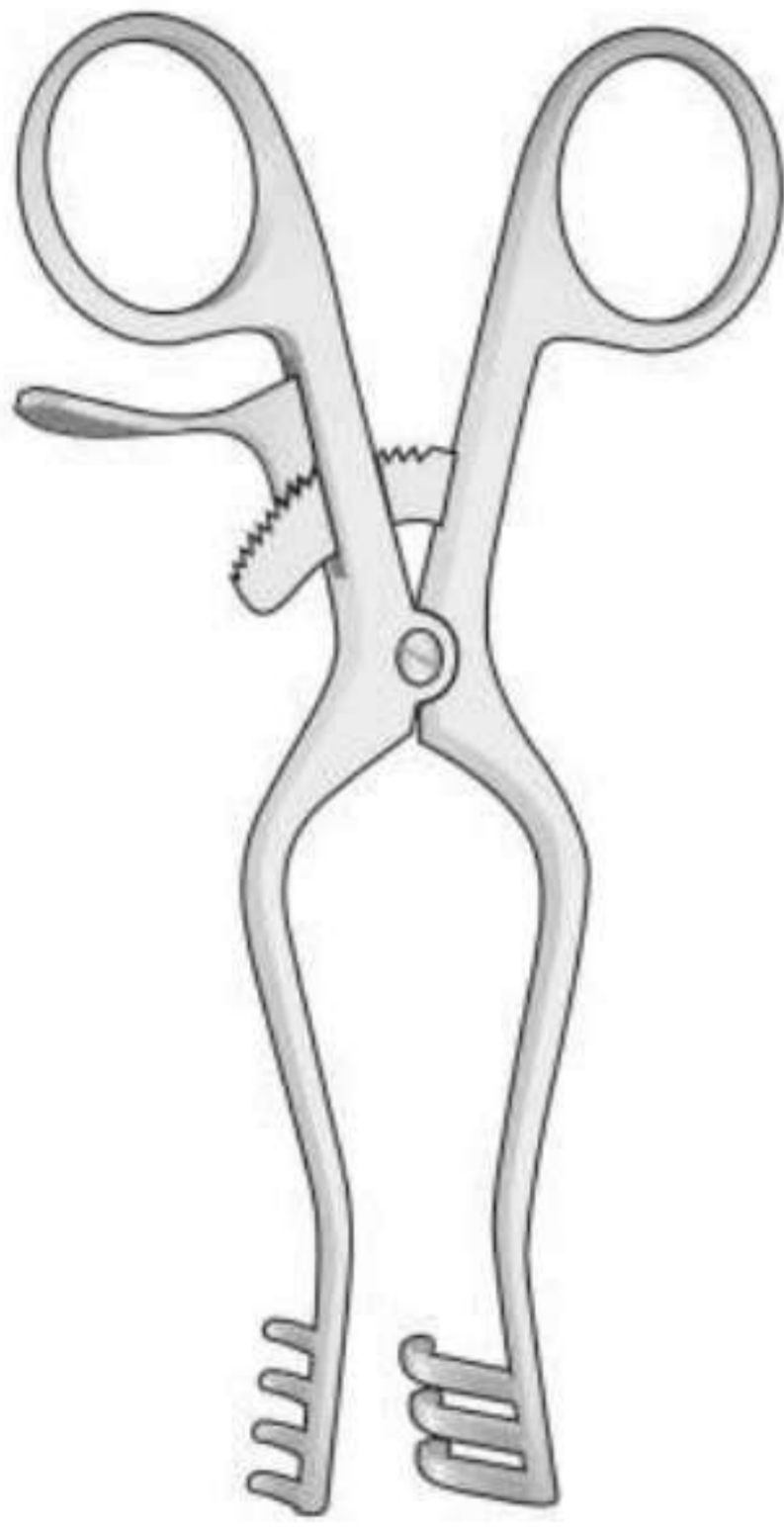

Stumpf - Blunt - Smusso
Romas - Mousse

Wundspreizer

Self retaining retractors

Divaricatori

Separadores

Ecarteurs

Wundspreizer

Self retaining retractors

Divaricatori

Separadores

Écarteurs

Halbscharf - Semi Sharp - Semi acuto
Semi Agudas - Semi Pointu

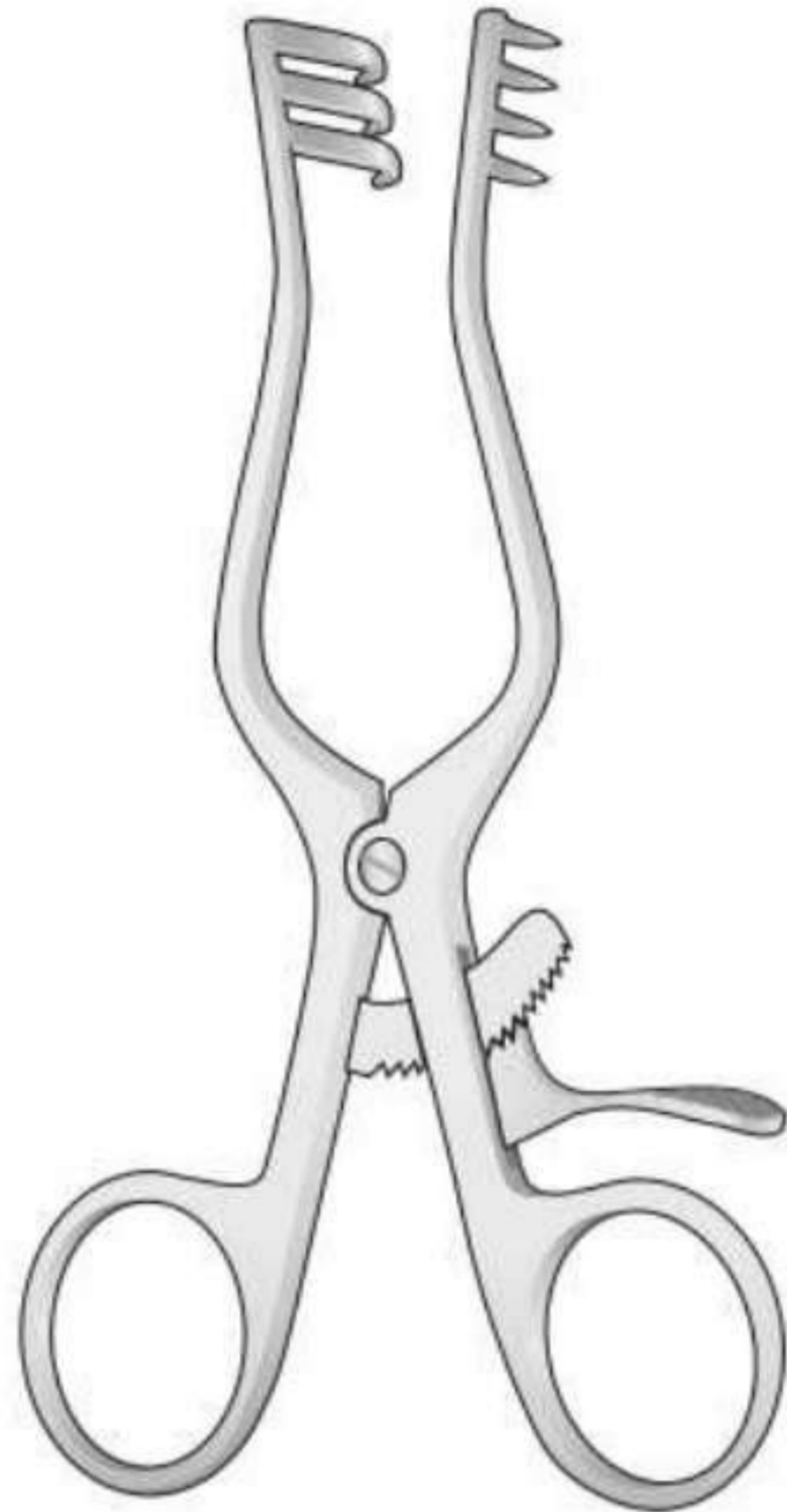
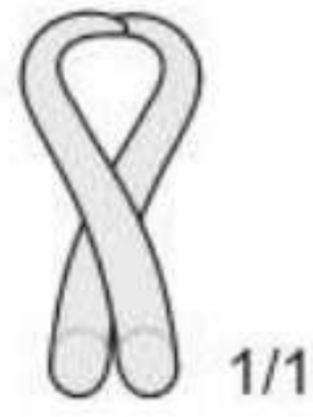

WEITLANER
BV-19
165 mm

Spitz - Sharp - Acuto
Agudas - Pointu

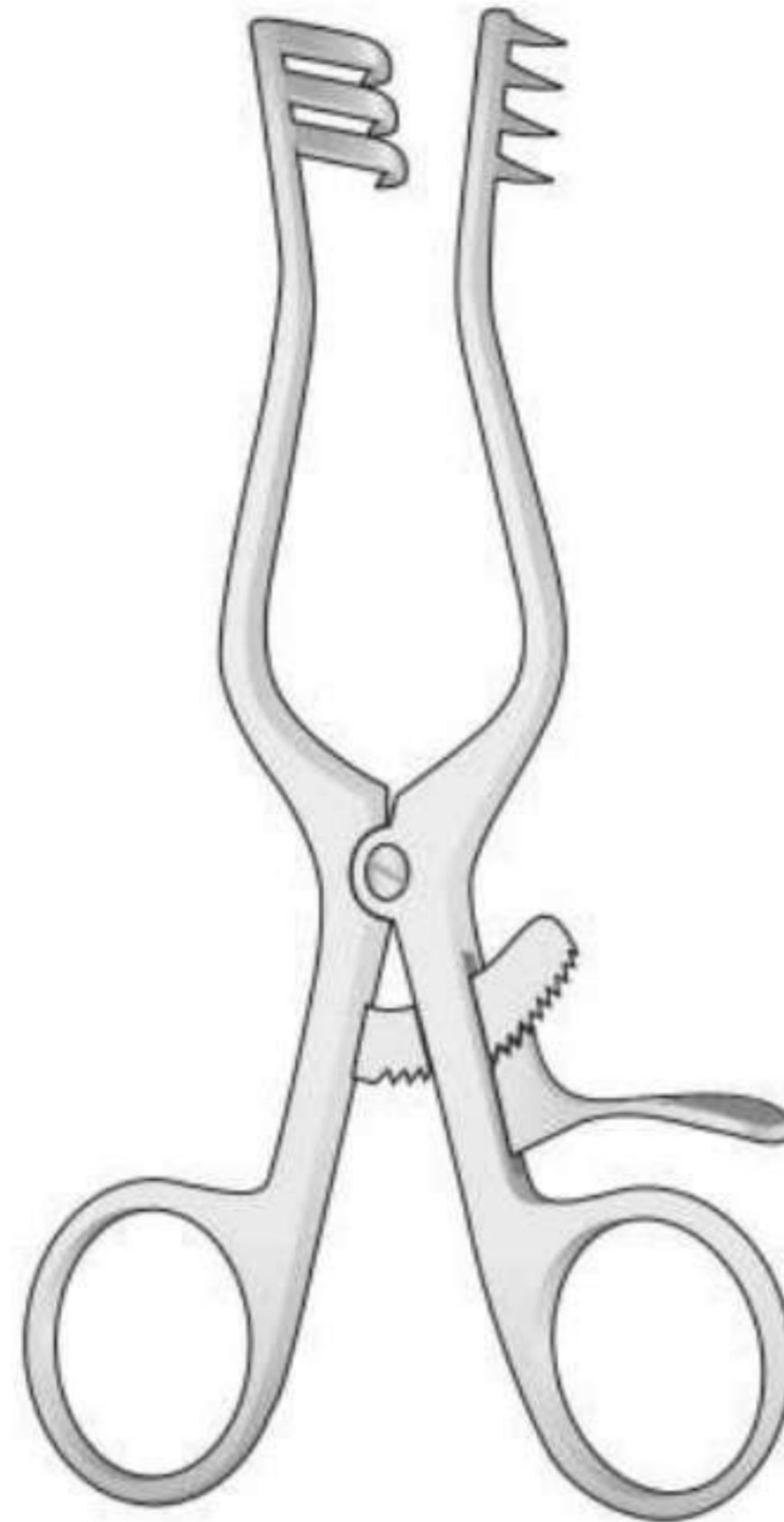

WEITLANER
BV-21
165 mm

Stumpf - Blunt - Smusso
Romas - Mousse

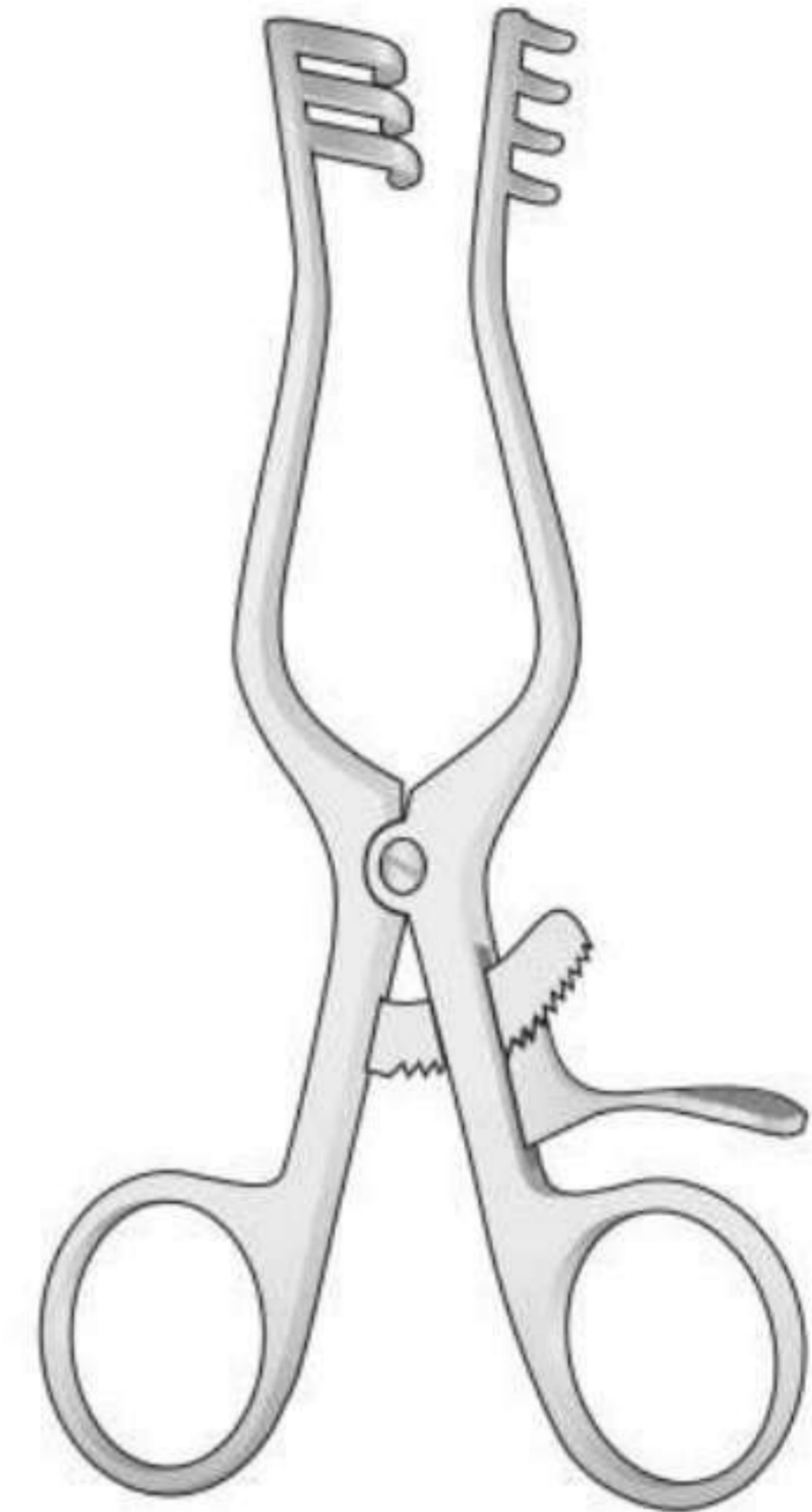
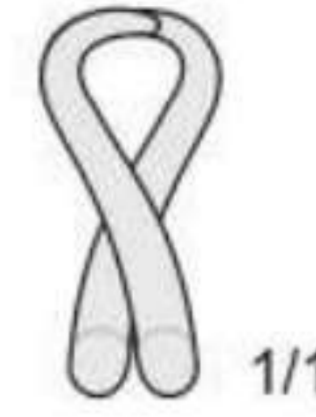

WEITLANER
BV-23
165 mm

Spitz - Sharp - Acuto
Agudas - Pointu

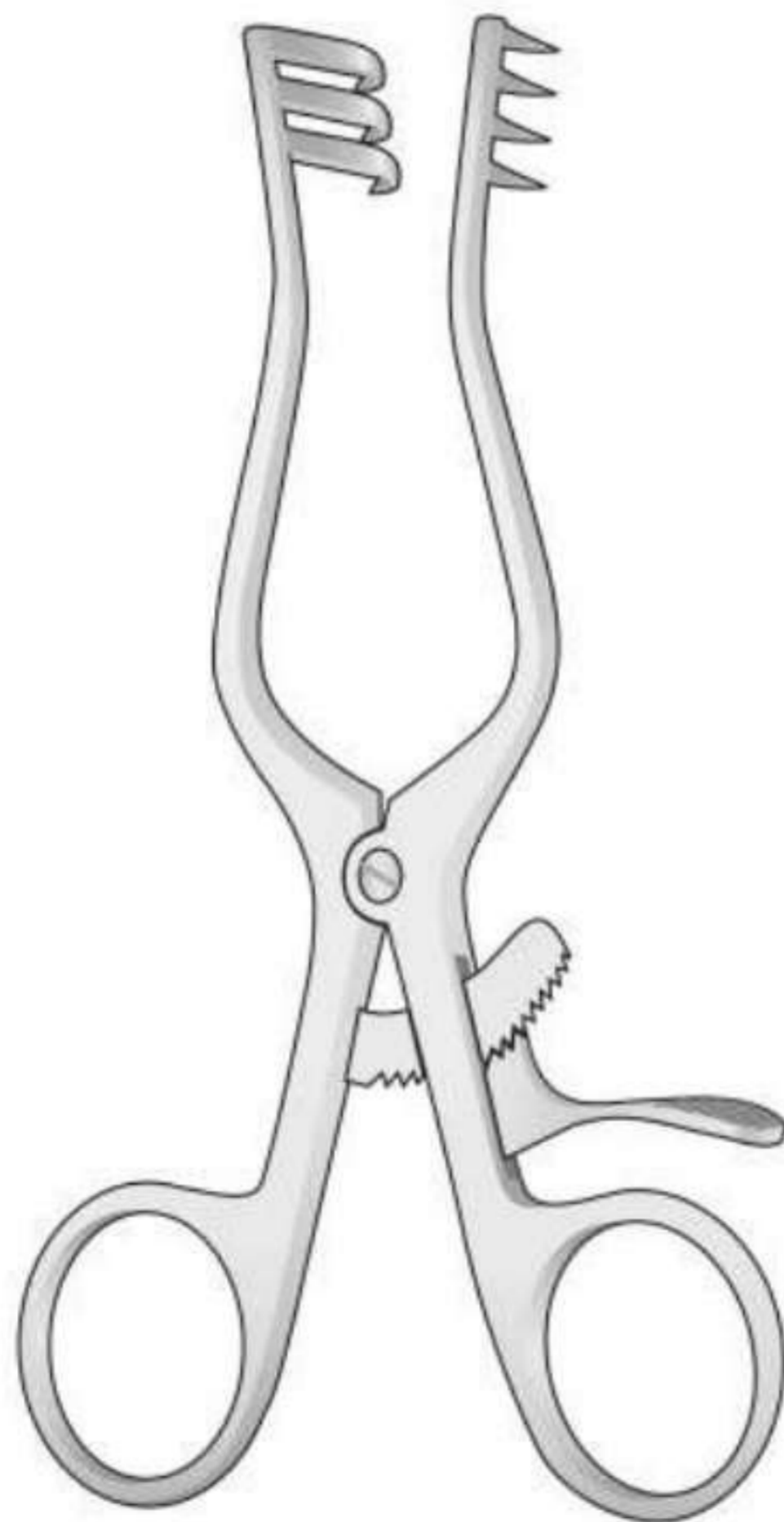

WEITLANER
BV-24
200 mm

Stumpf - Blunt - Smusso
Romas - Mousse

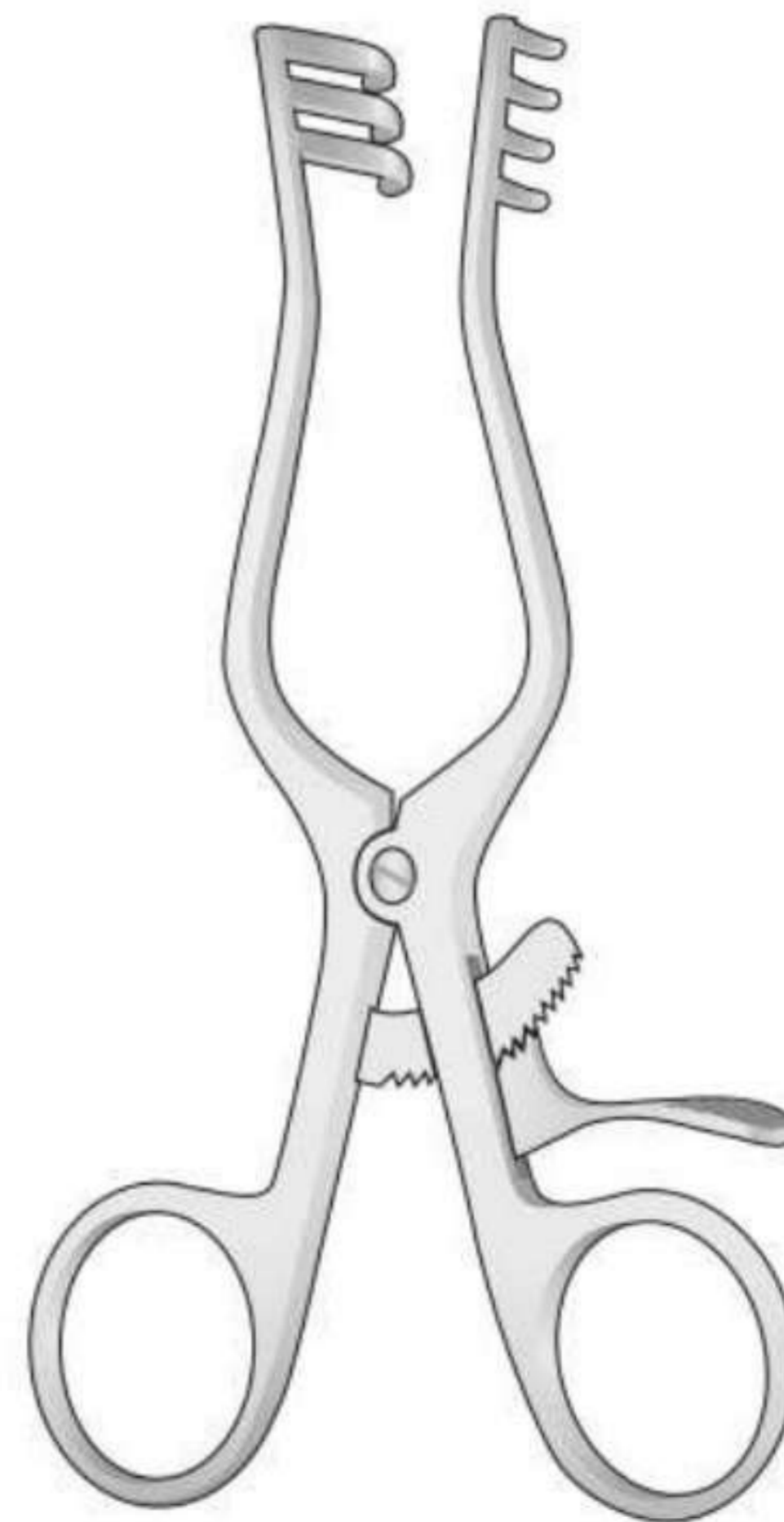

WEITLANER
BV-25
200 mm

Spitz - Sharp - Acuto
Agudas - Pointu

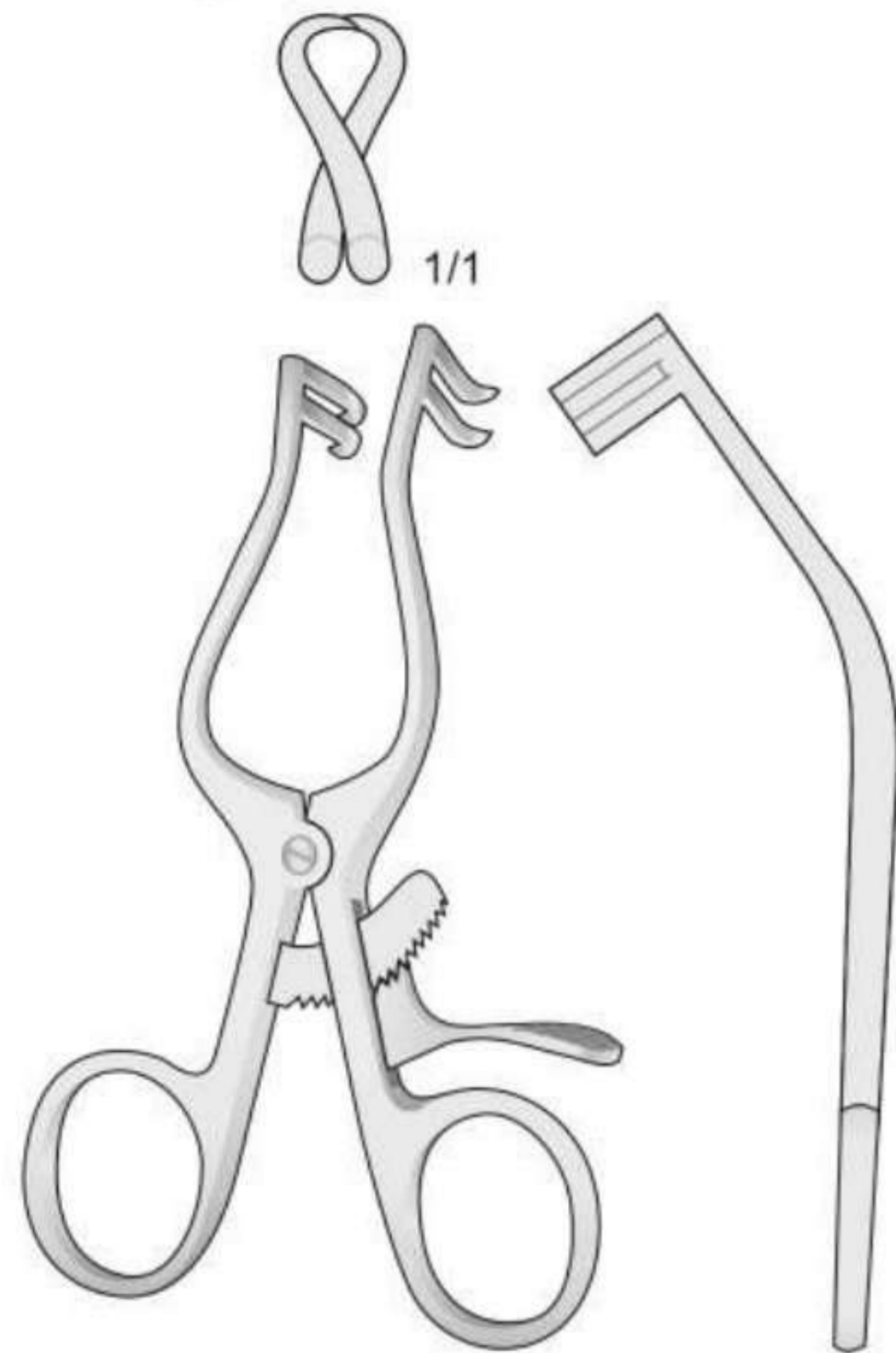

PLESTER
BV-90
110 mm

Stumpf - Blunt - Smusso
Romas - Mousse

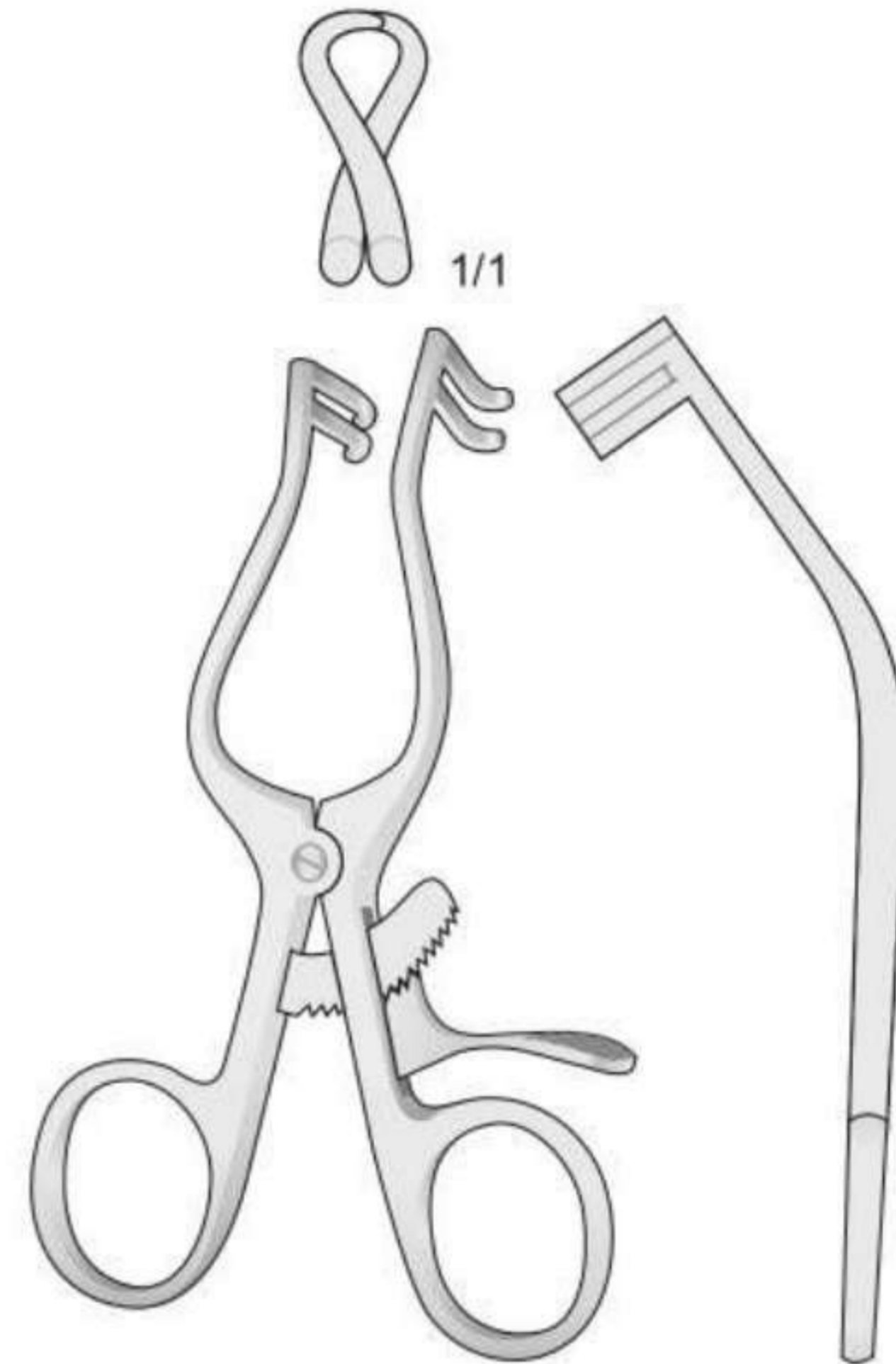

PLESTER
BV-91
110 mm

Spitz - Sharp - Acuto
Agudas - Pointu

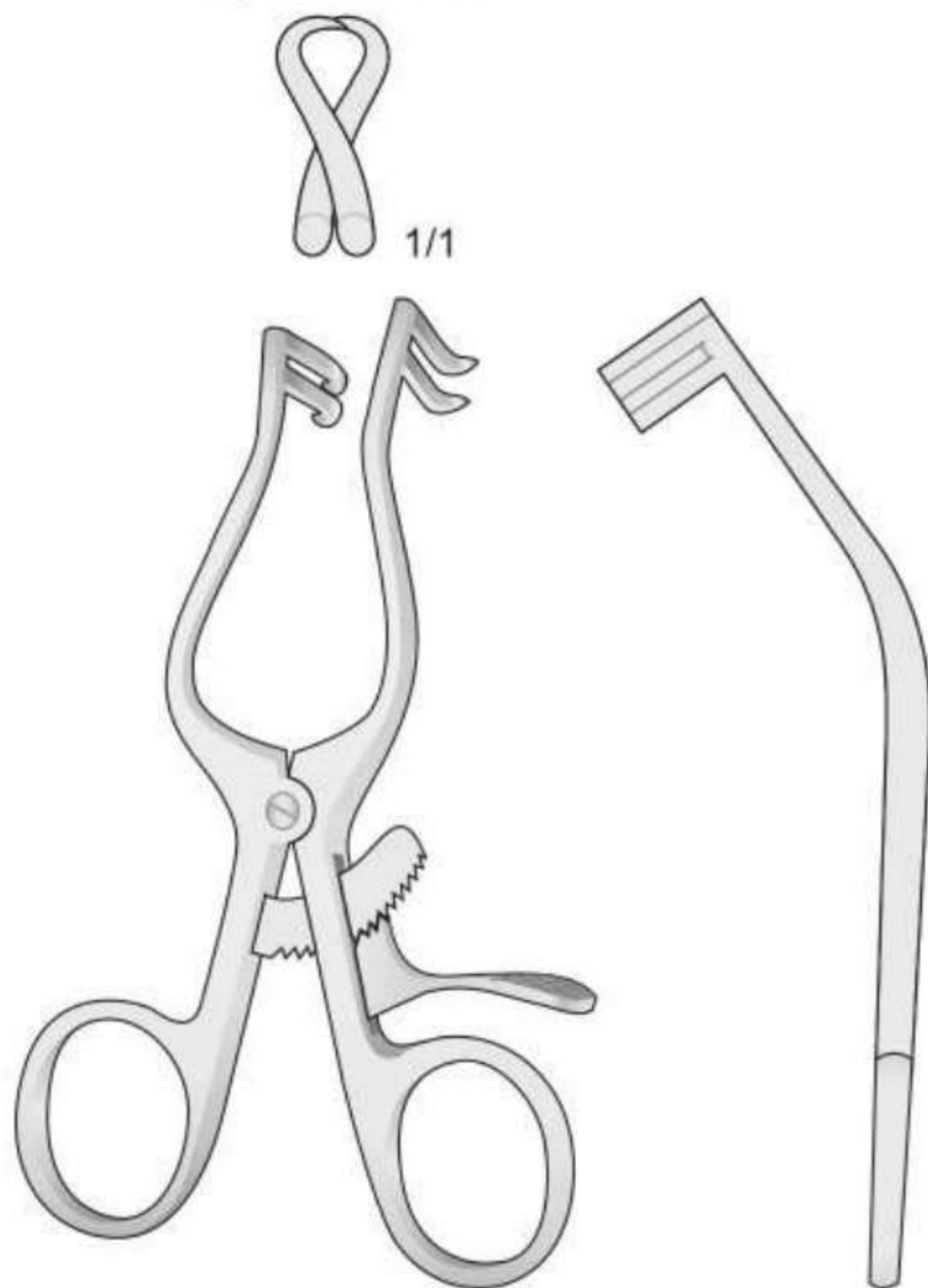

PLESTER
BV-92
135 mm

Stumpf - Blunt - Smusso
Romas - Mousse

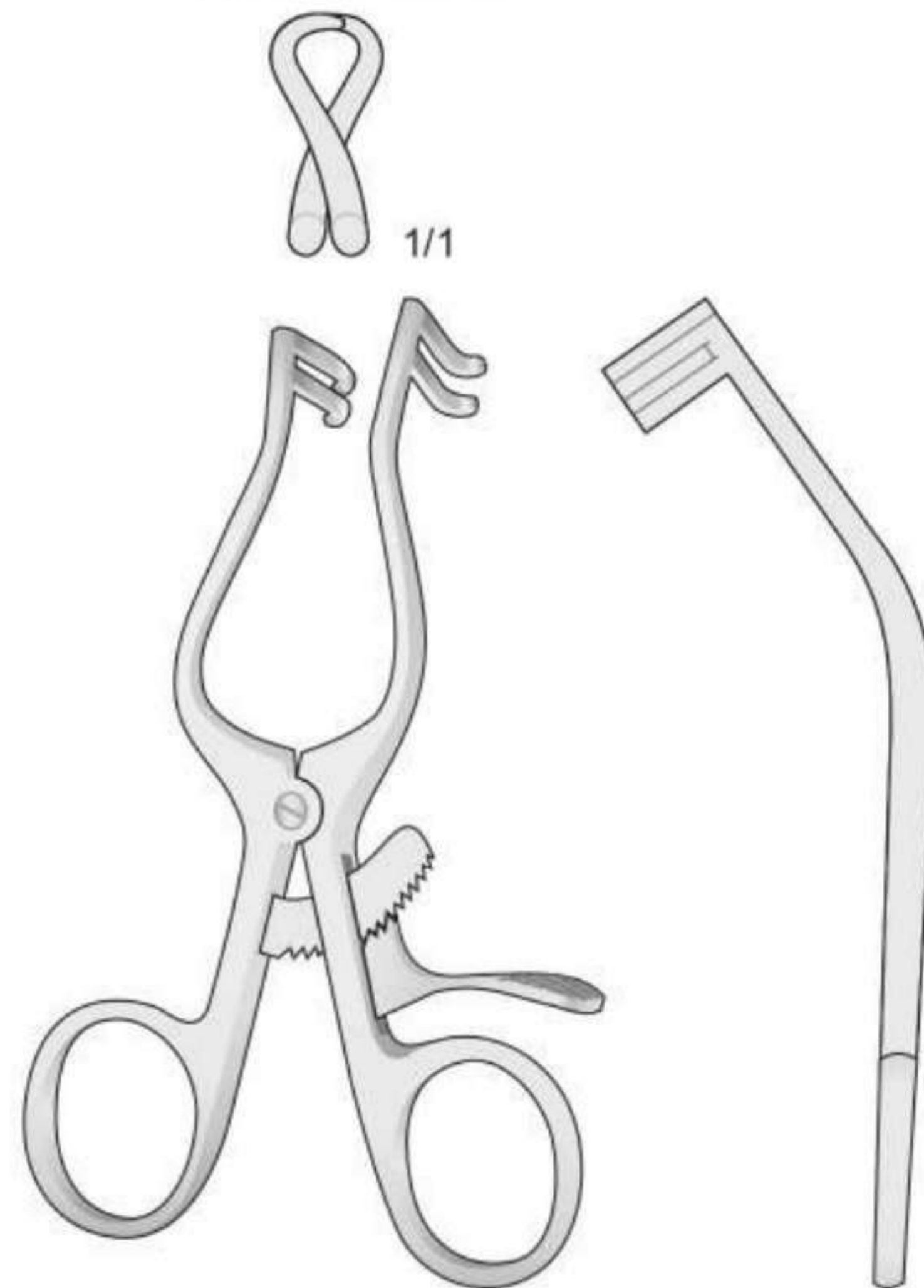

PLESTER
BV-93
135 mm

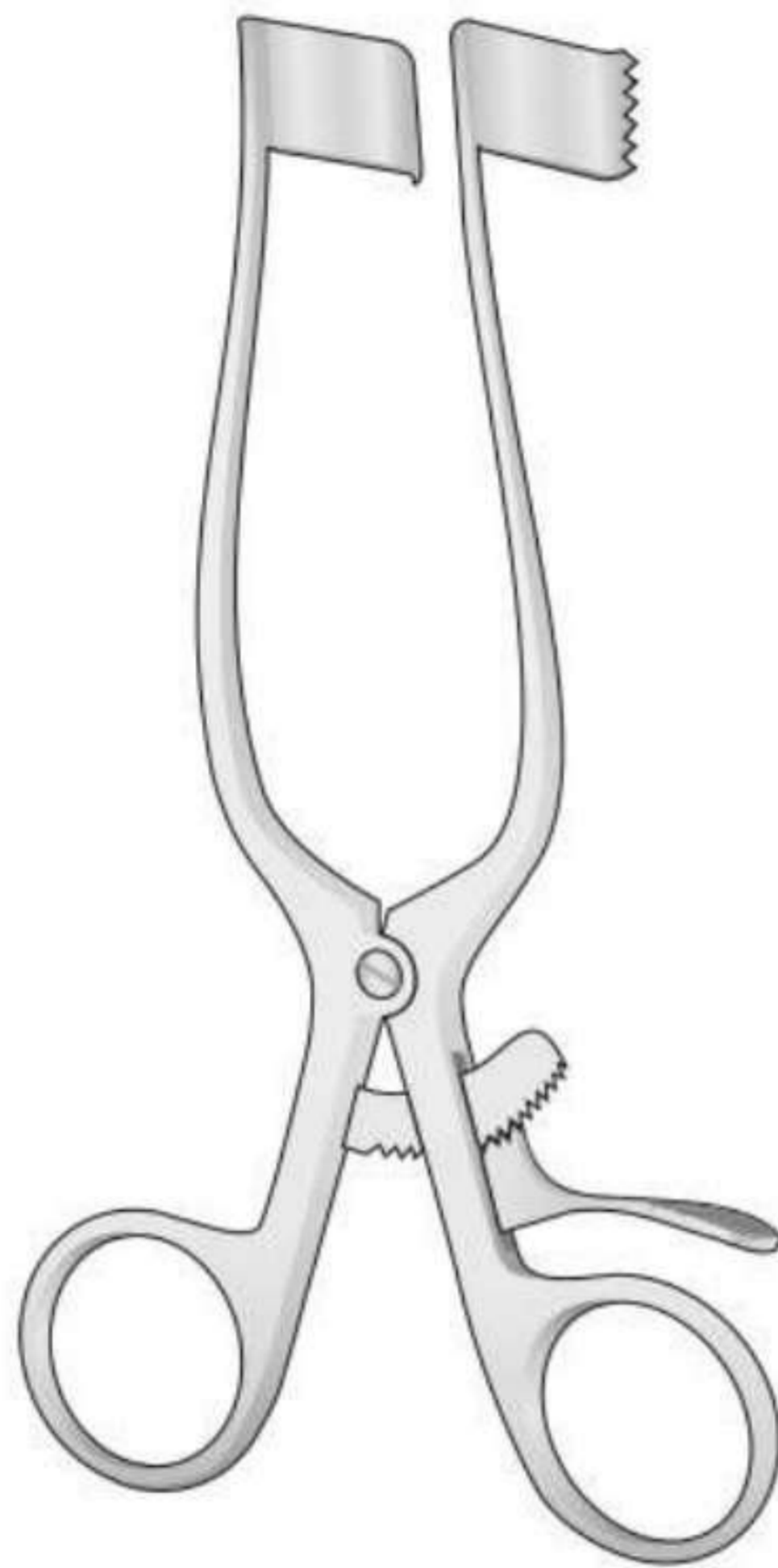

MEYERDING
BV-76 - 32 x 25 mm
BV-77 - 60 x 25 mm
BV-78 - 54 x 25 mm
BV-79 - 60 x 20 mm
 180 mm

Spitz - Sharp - Acuto
 Agudas - Pointu

Stumpf - Blunt - Smusso
 Romas - Mousse

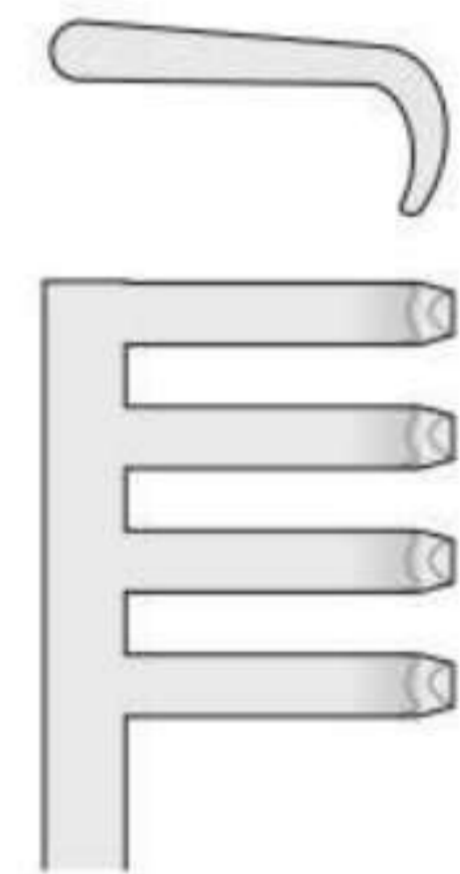
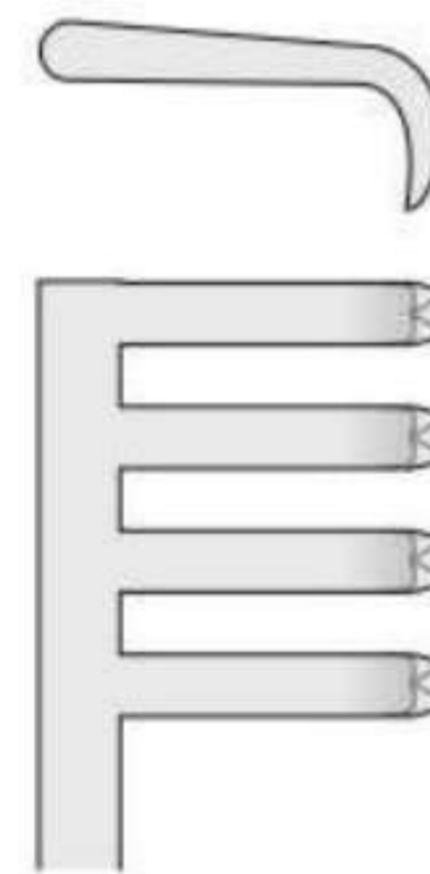

BV-117

BV-118

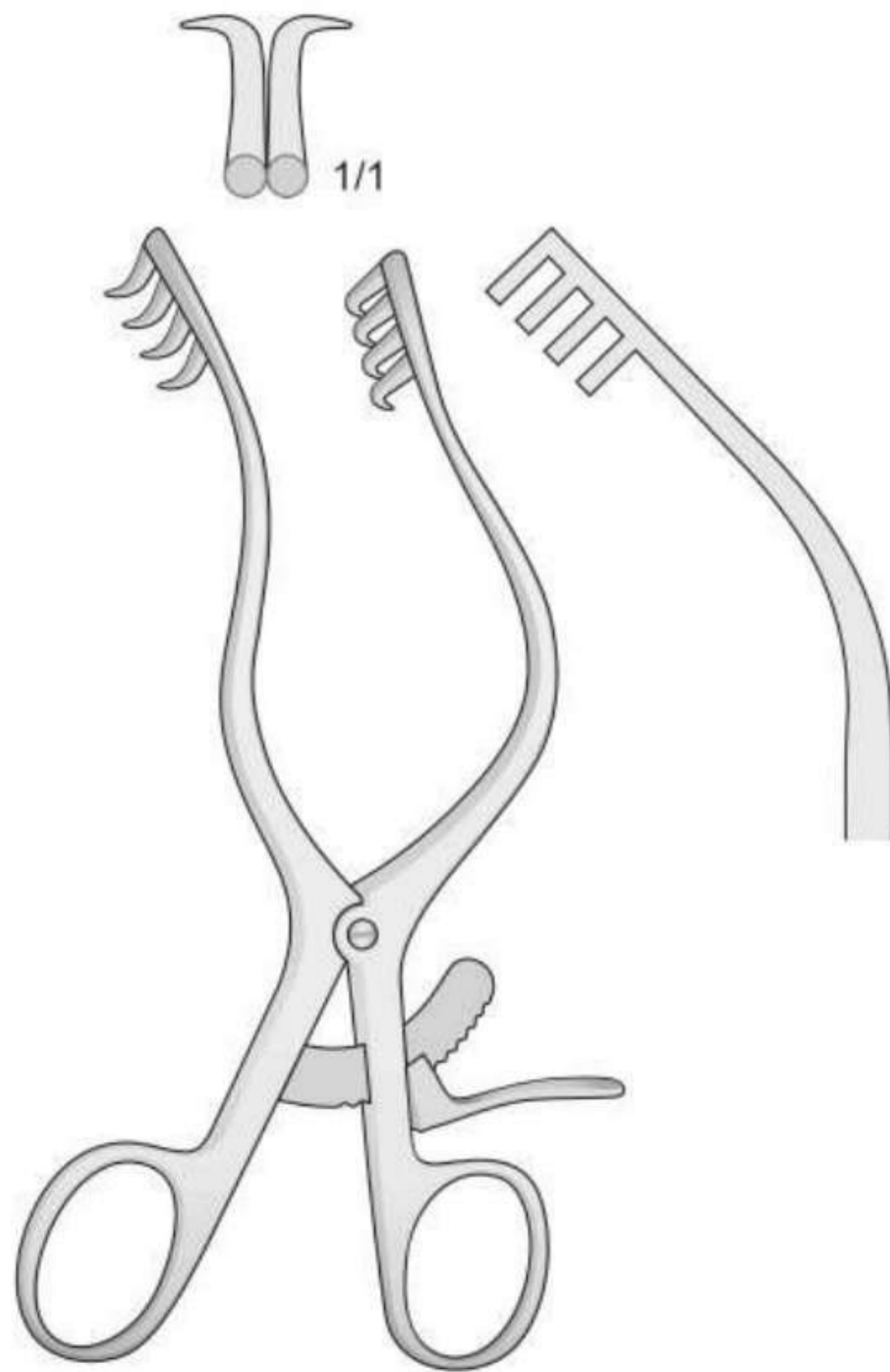

MOLLISON
BV-110
 160 mm

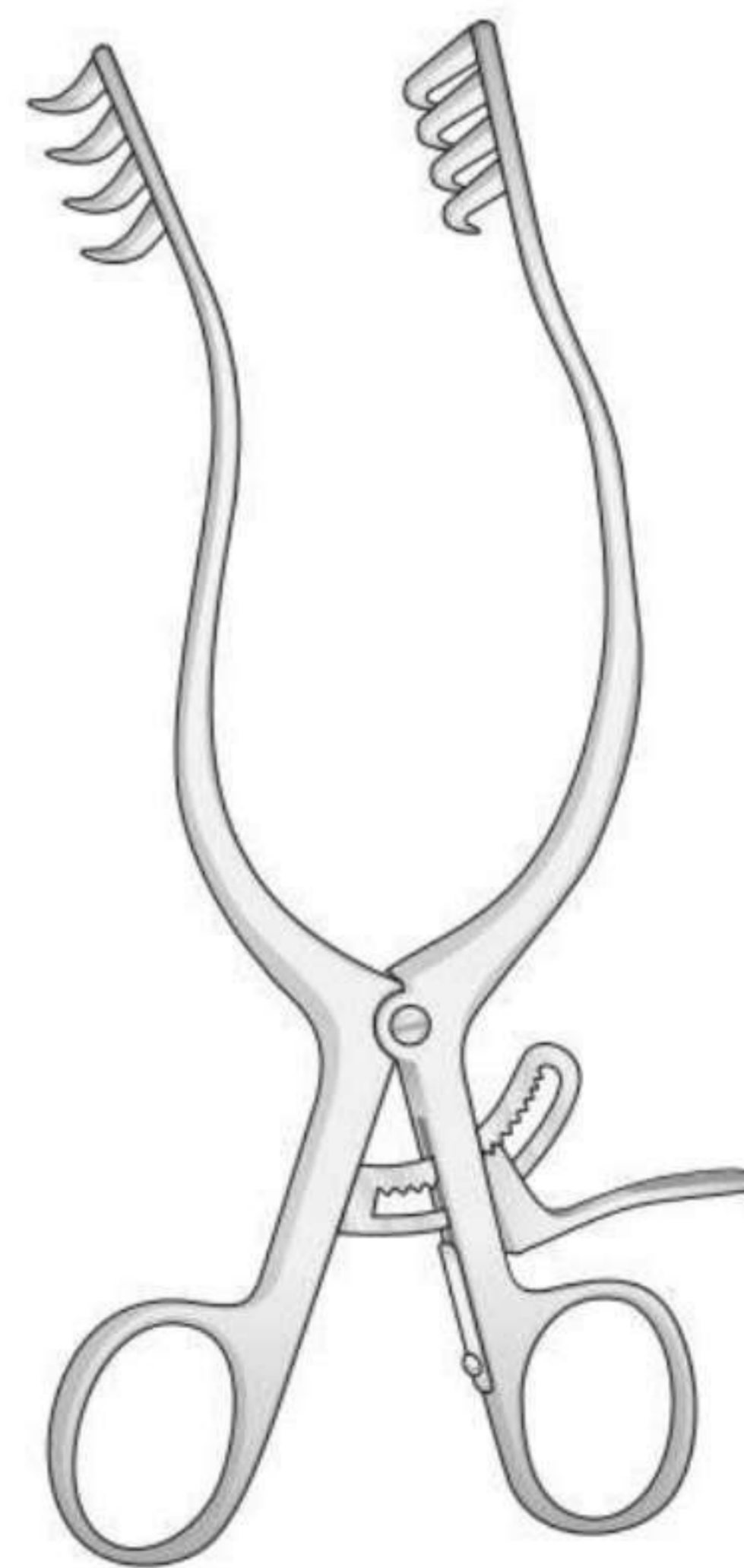

ANDERSON-ADSON
BV-117/BV-118
 200 mm

Spitz - Sharp - Acuto
Agudas - Pointu

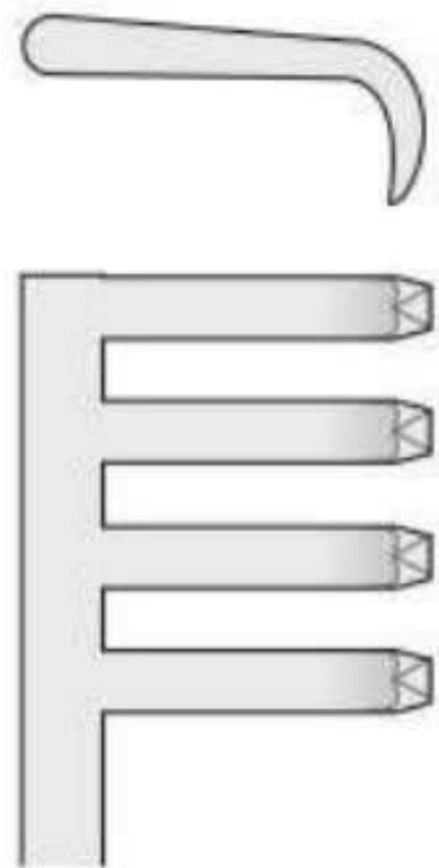

BV-119

Stumpf - Blunt - Smusso
Romas - Mousse

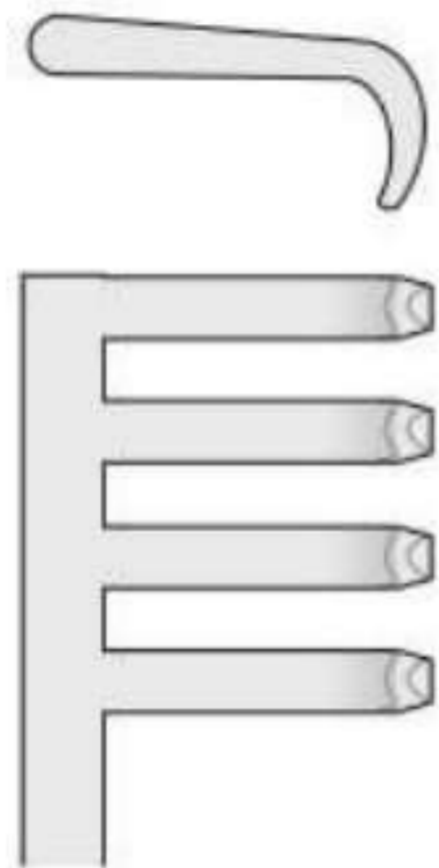

BV-120

4 x 4 Zähne
4 x 4 Teeth
4 x 4 Denti
4 x 4 Dientes
4 x 4 Dents

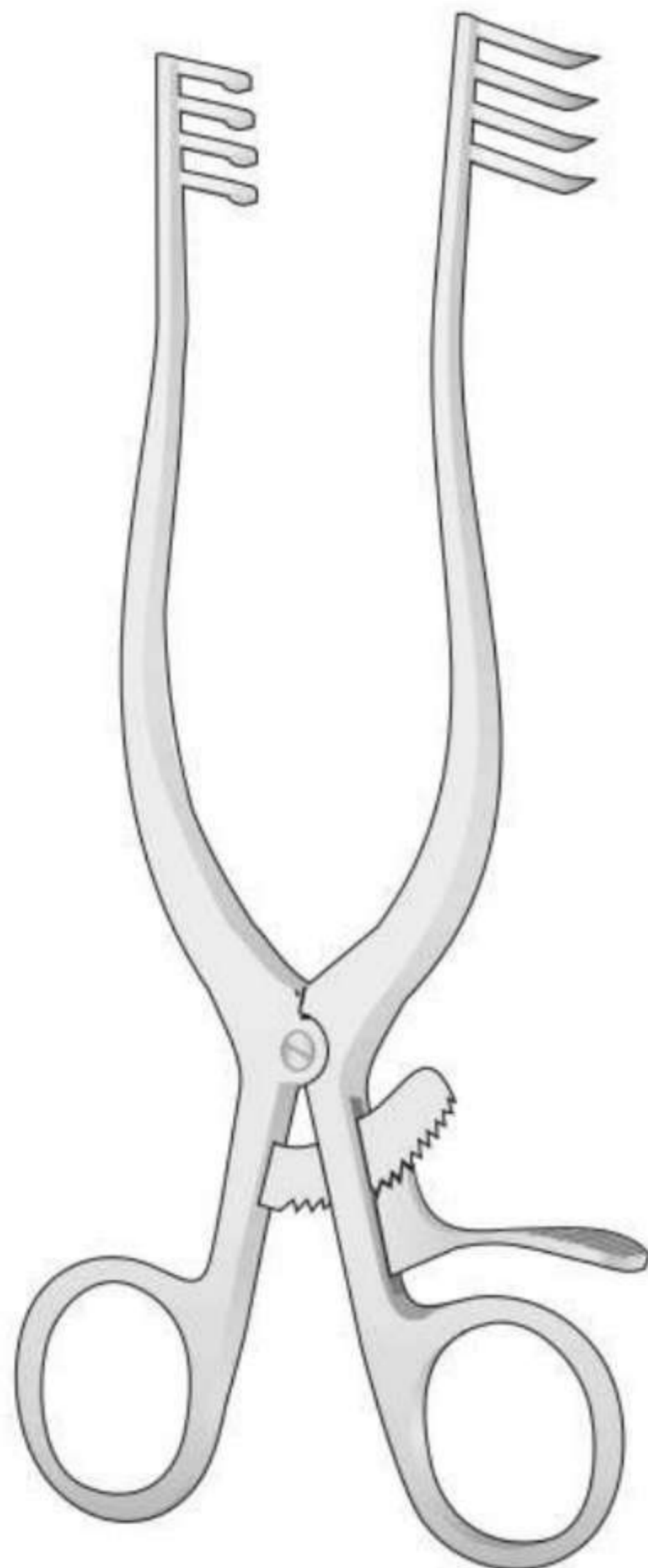

**ADSON
BV-119/BV-120
200 mm**

Spitz - Sharp - Acuto
Agudas - Pointu

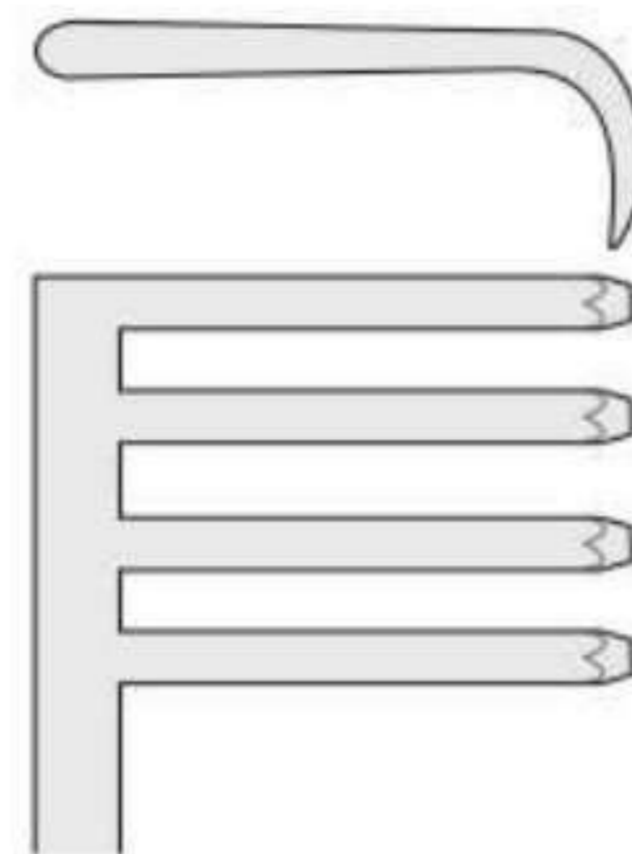

BV-27

Stumpf - Blunt - Smusso
Romas - Mousse

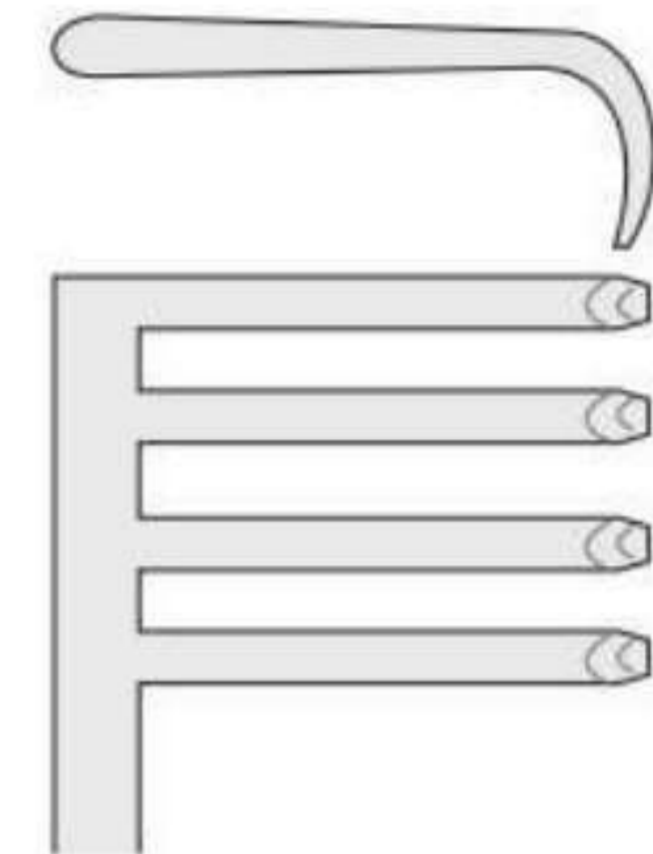

BV-28

4 x 4 Zähne
4 x 4 Teeth
4 x 4 Denti
4 x 4 Dientes
4 x 4 Dents

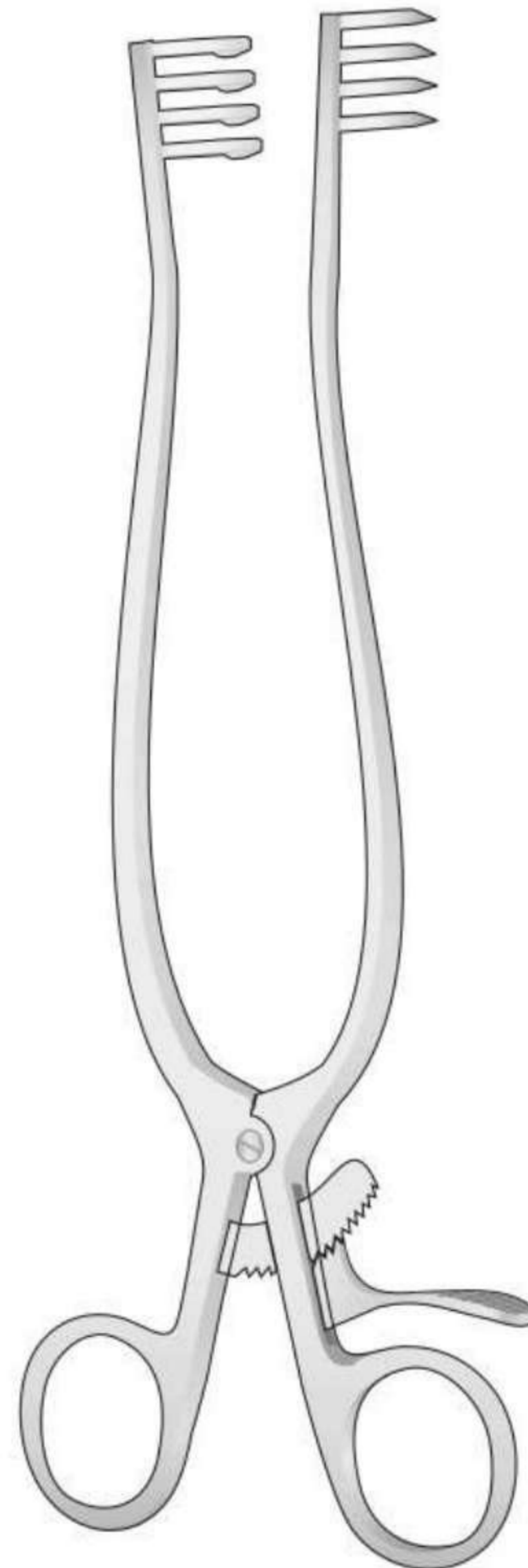

**WEITLANER
BV-27/BV-28
250 mm**

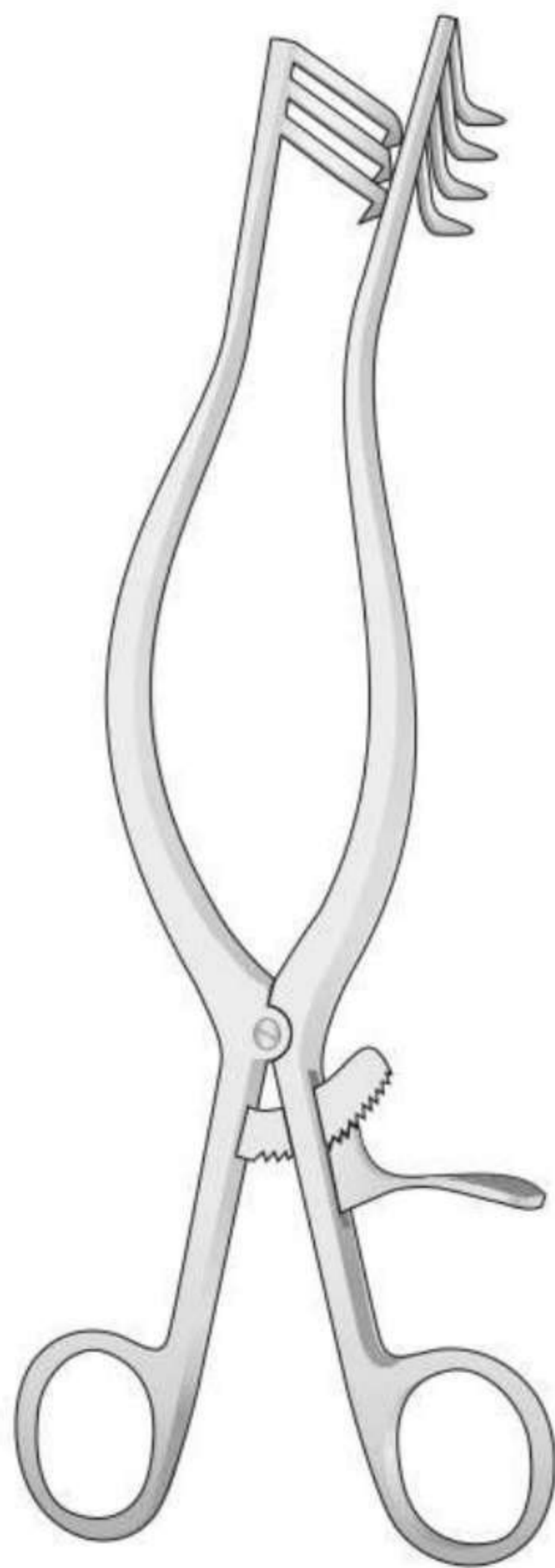

ADSON
BV-190/BV-193
 265 mm

3 x 4 Zähne
 3 x 4 Teeth
 3 x 4 Denti
 3 x 4 Dientes
 3 x 4 Dents

Spitz
 Sharp
 Acuto
 Agudas
 Pointu

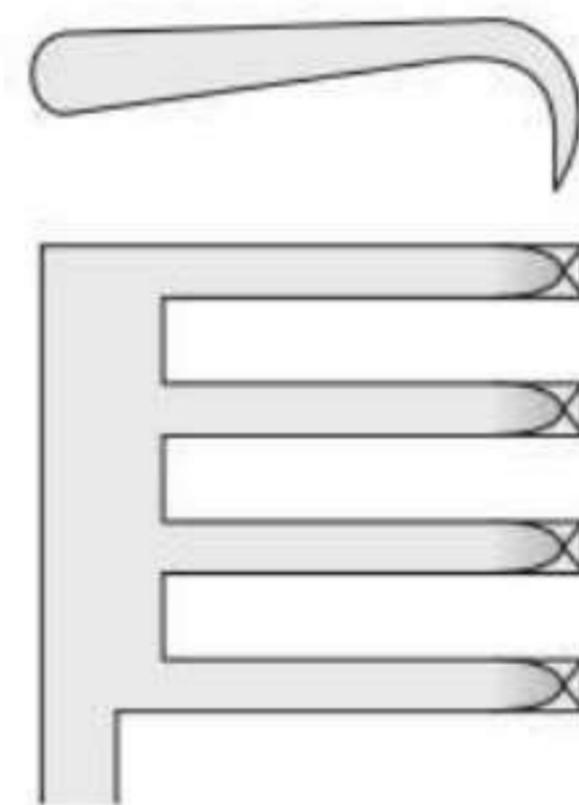

BV-190

Stumpf
 Blunt
 Smusso
 Romas
 Mousse

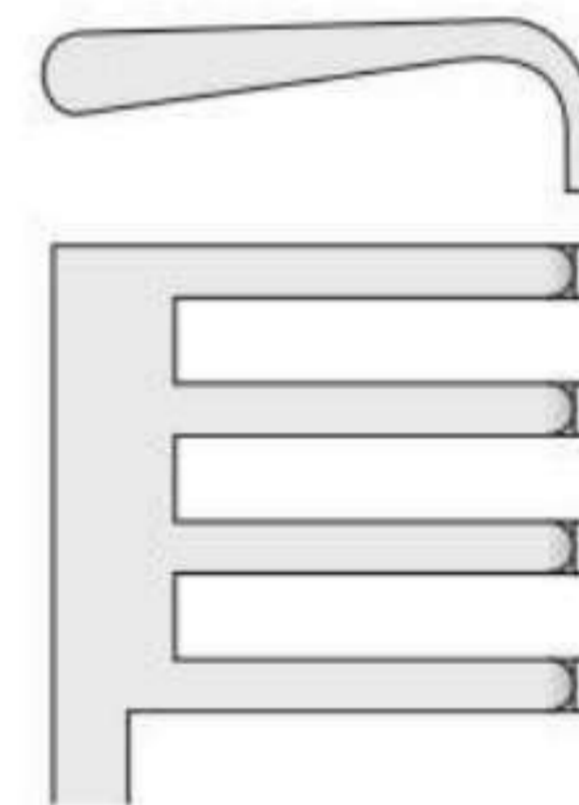

BV-191

6 x 6 Zähne
 6 x 6 Teeth
 6 x 6 Denti
 6 x 6 Dientes
 6 x 6 Dents

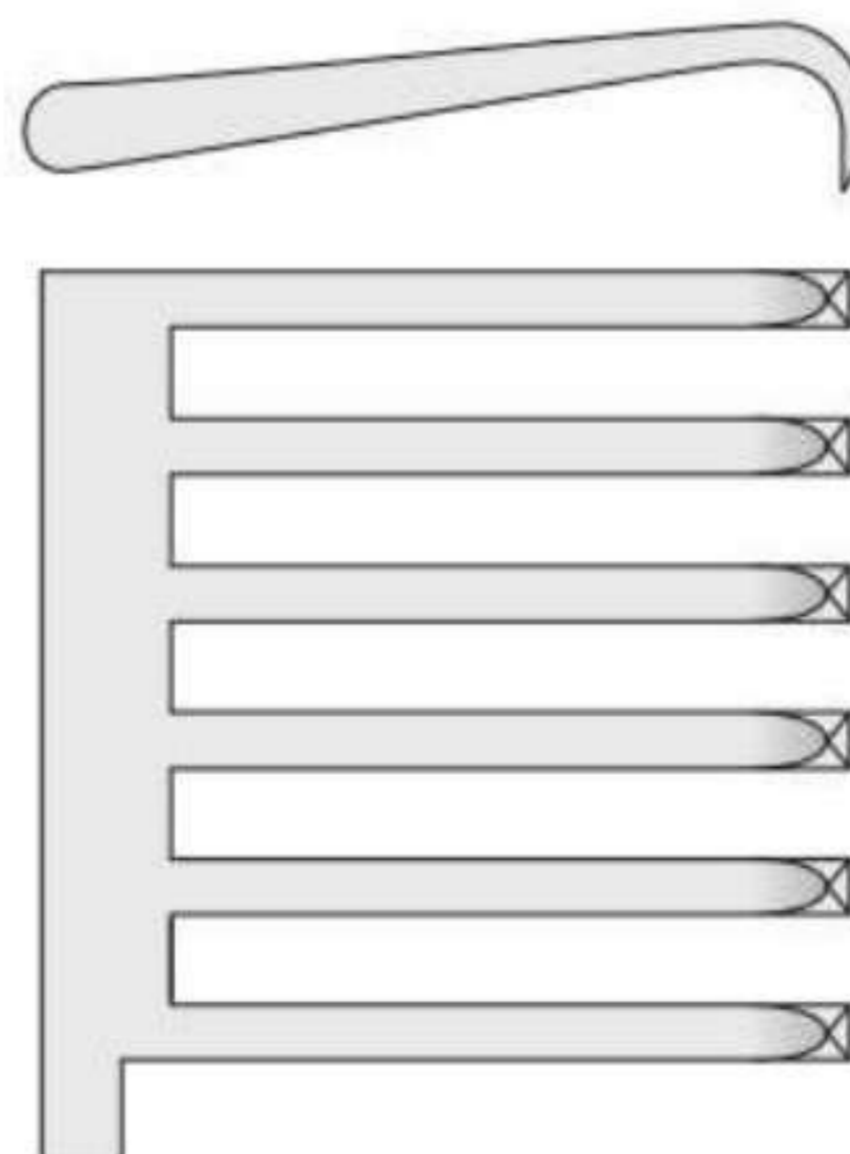

BV-192

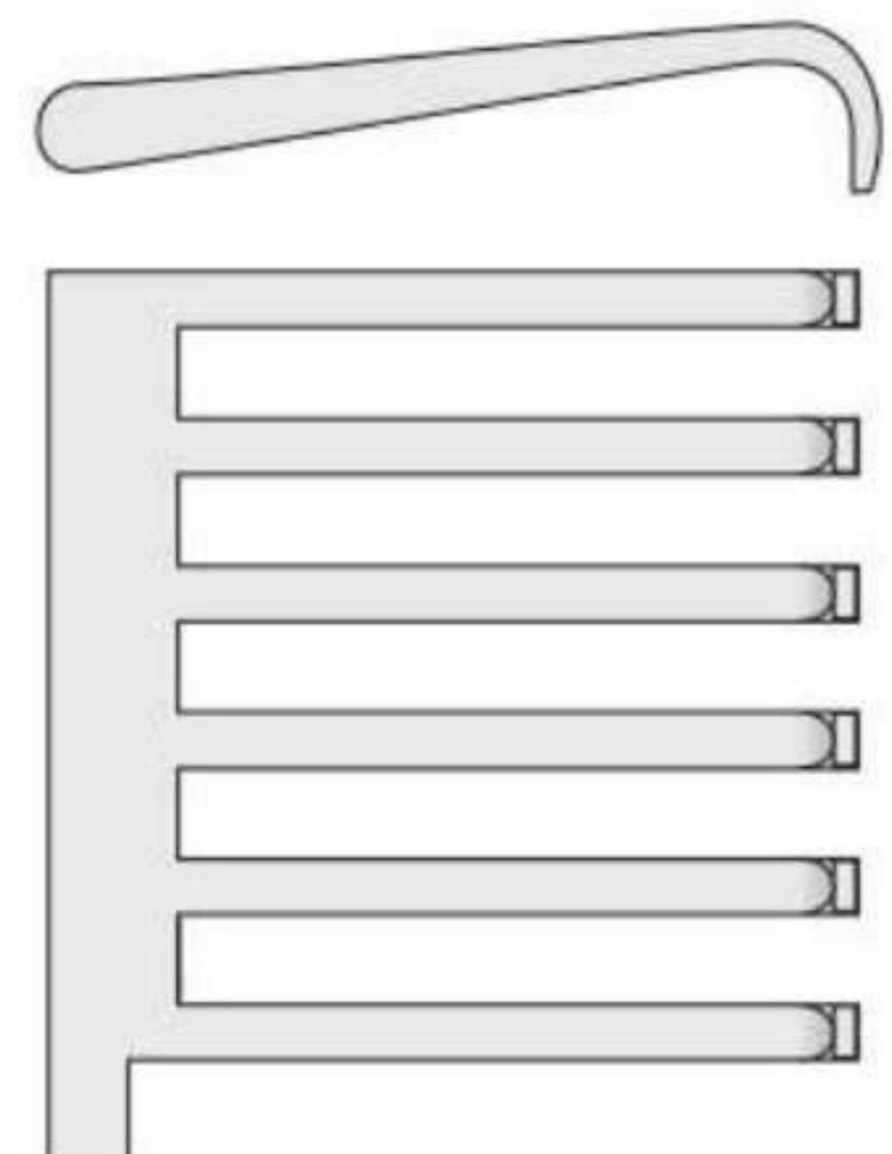

BV-193

Wundspreizer

Self retaining retractors

Divaricatori

Separadores

Écarteurs

Spitz
Scharp
Acuto
Agudo
Pointu

Stumpf
Blunt
Smusso
Romas
Mousse

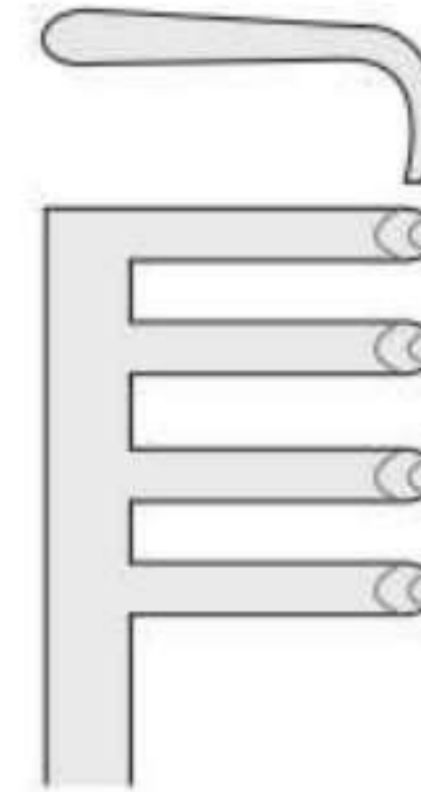
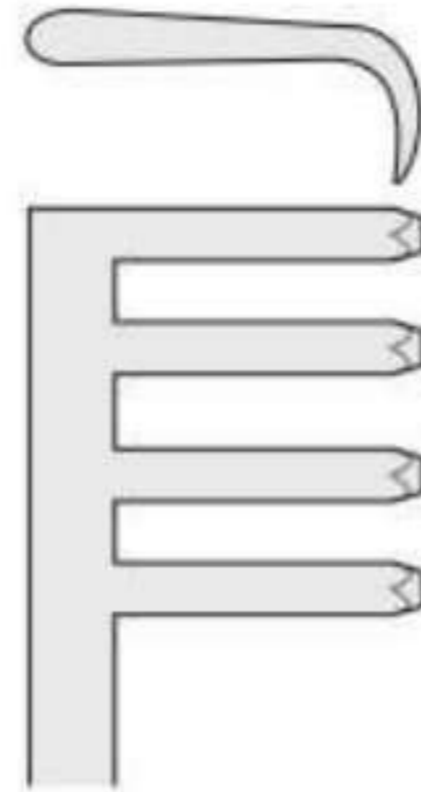

BV-68
140 mm

BV-70
140 mm

3 x 4 Zähne
3 x 4 Teeth
3 x 4 Denti
3 x 4 Dientes
3 x 4 Dents

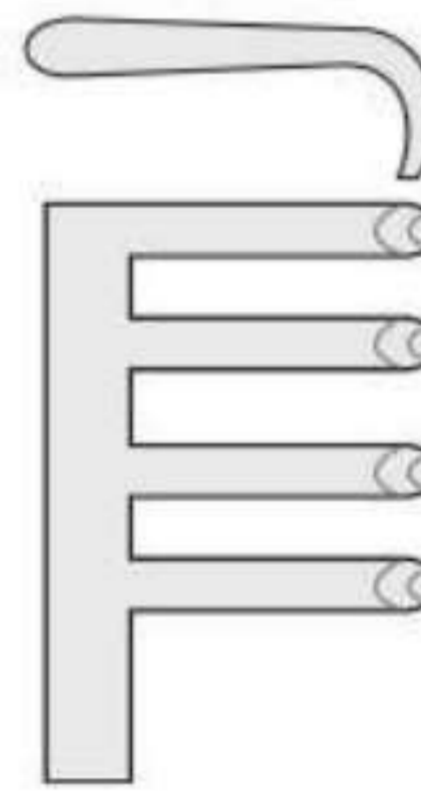
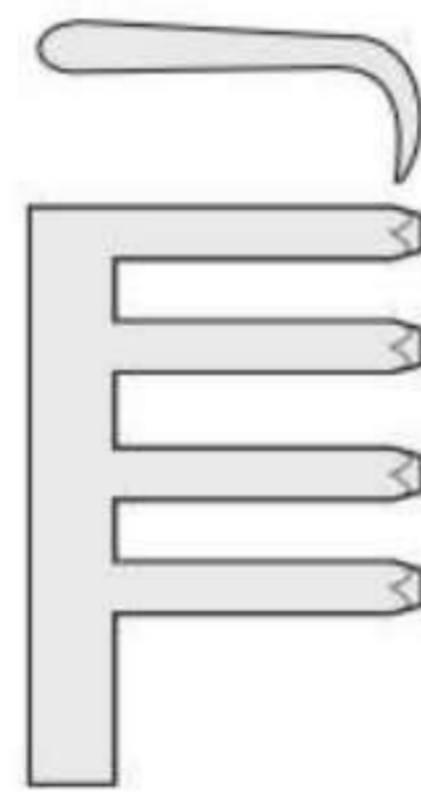

BV-69
165 mm

BV-71
165 mm

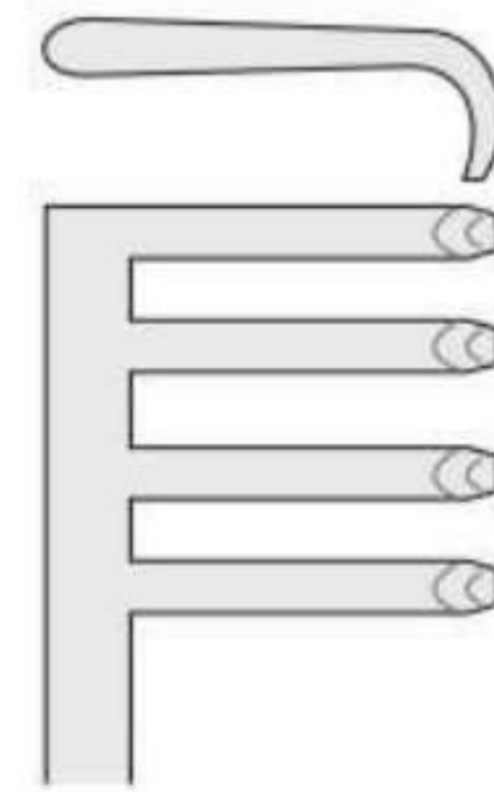
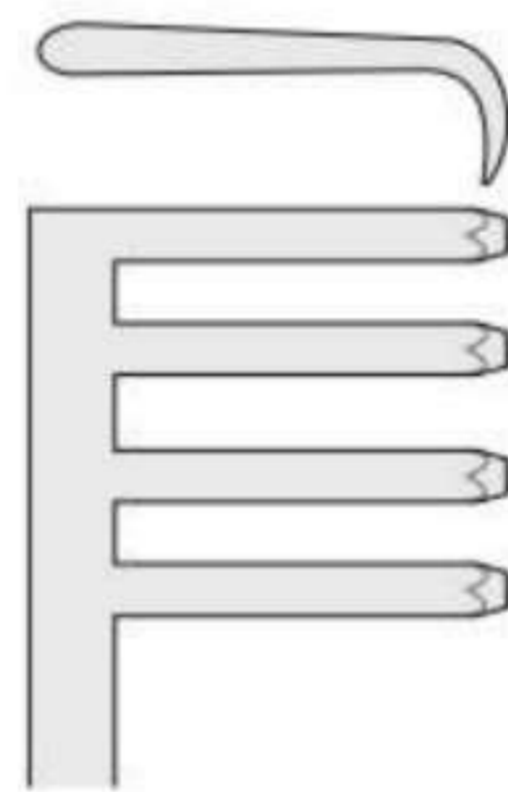

BV-72
200 mm

BV-73
200 mm

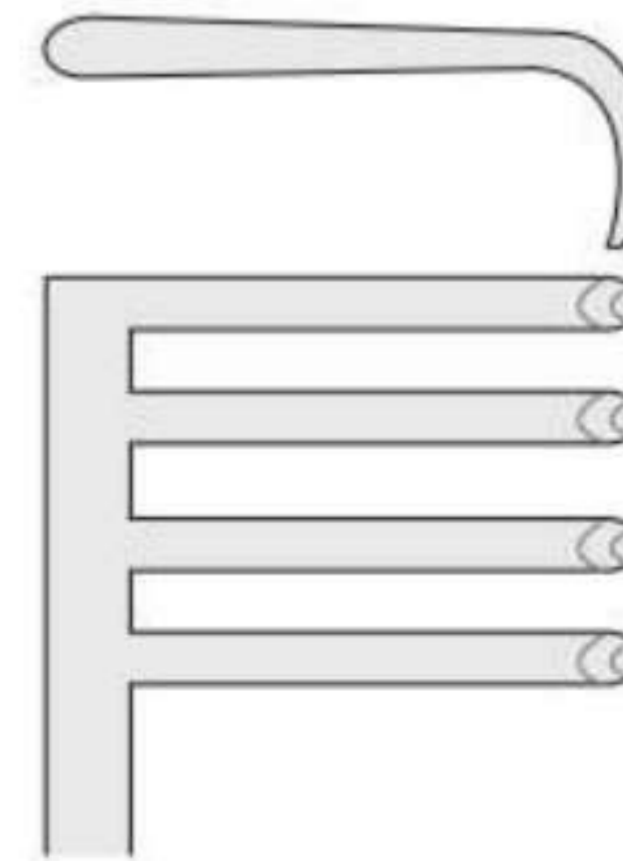
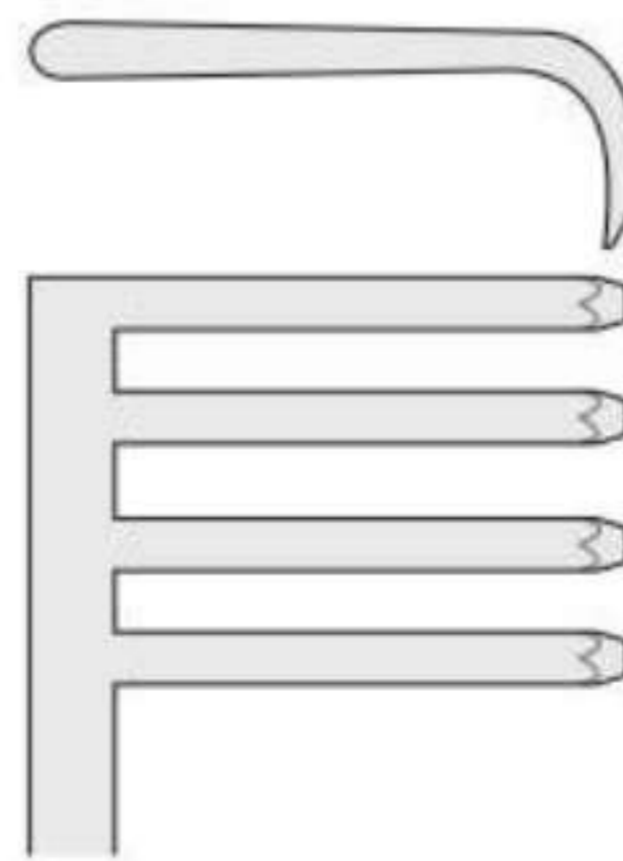

BV-74
250 mm

BV-75
250 mm

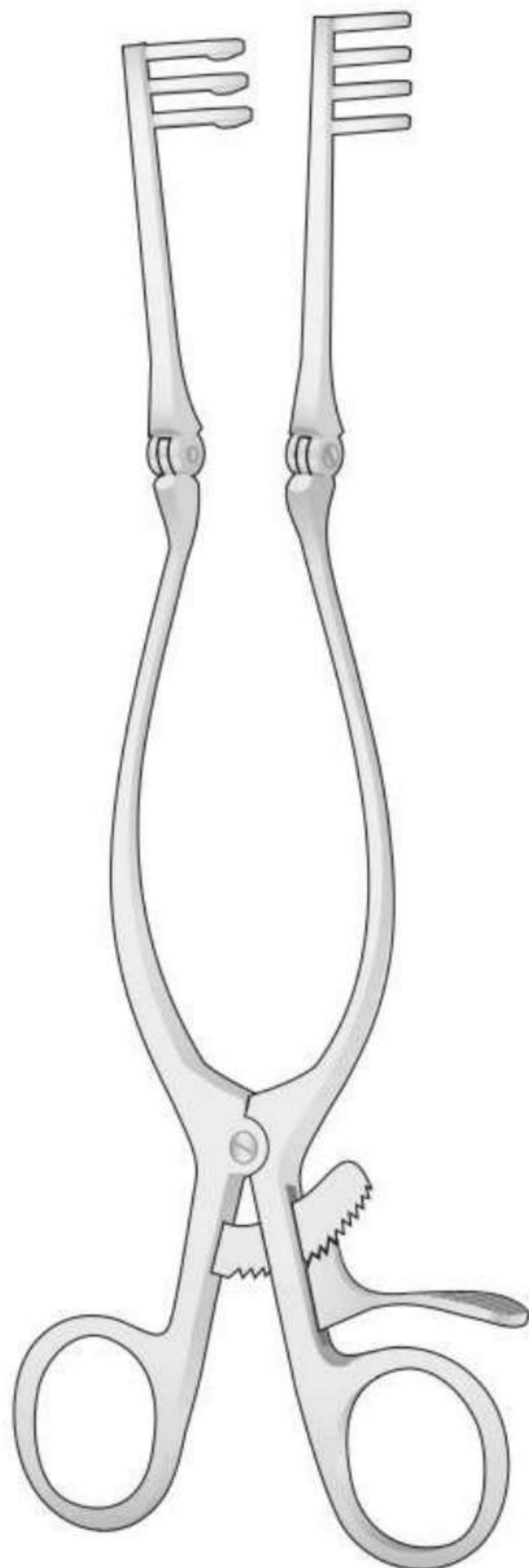

ADSON
BV-68/BV-75



TRS INSTRUMENTS

TRAUMATOLOGY AND ORTHOPAEDICS

Elevators

Elevatorien
Élévateurs
Elevadores
Elevatori

Periosteal (Raspatories)

Raspatorien
Rugines périostiques
Periostótomos (Legras)
Scollaperiosteo (Periostotomi)

Bone files

Knochenfeilen
Limes à os
Limas para hueso
Lime per osso

Sharp Curettes

Scharfe Küretten
Curettes tranchantes
Curetas cortantes
Curette taglienti

Elevatorien

Elevators

Elevatori

Elevadores

Élévateurs

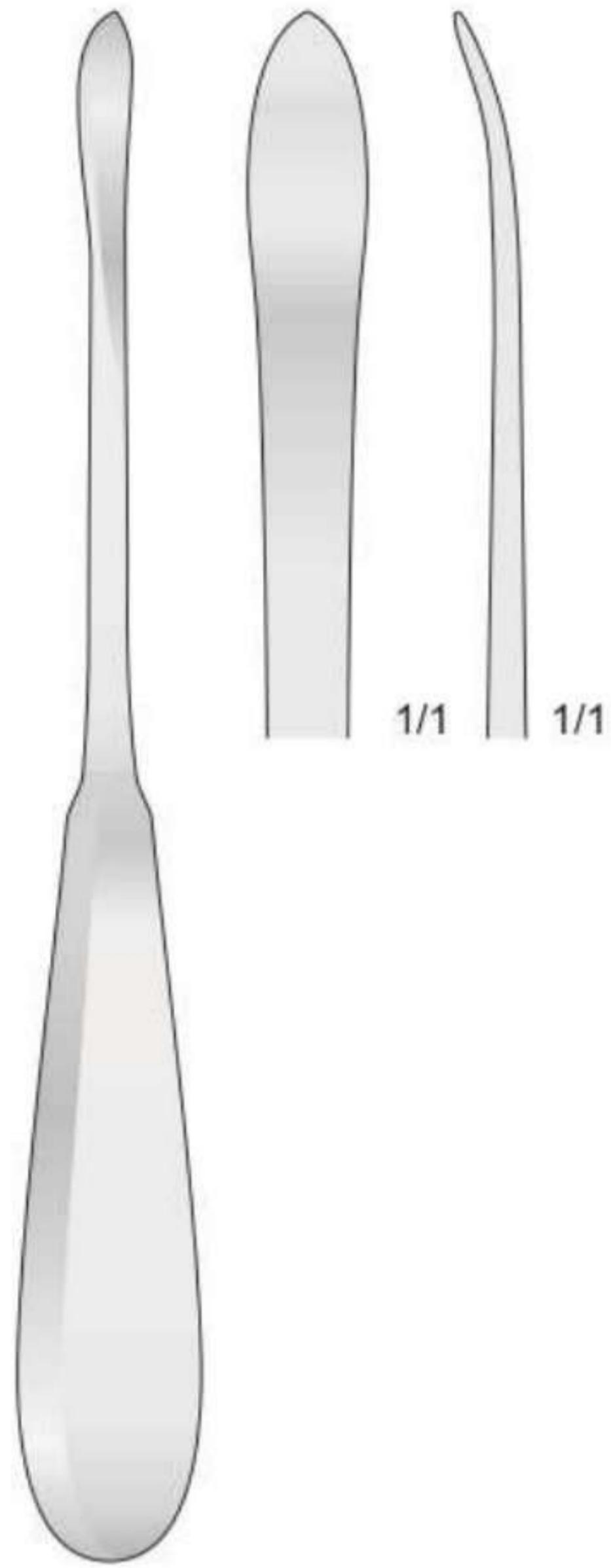

LANGENBECK
FK-12
200 mm

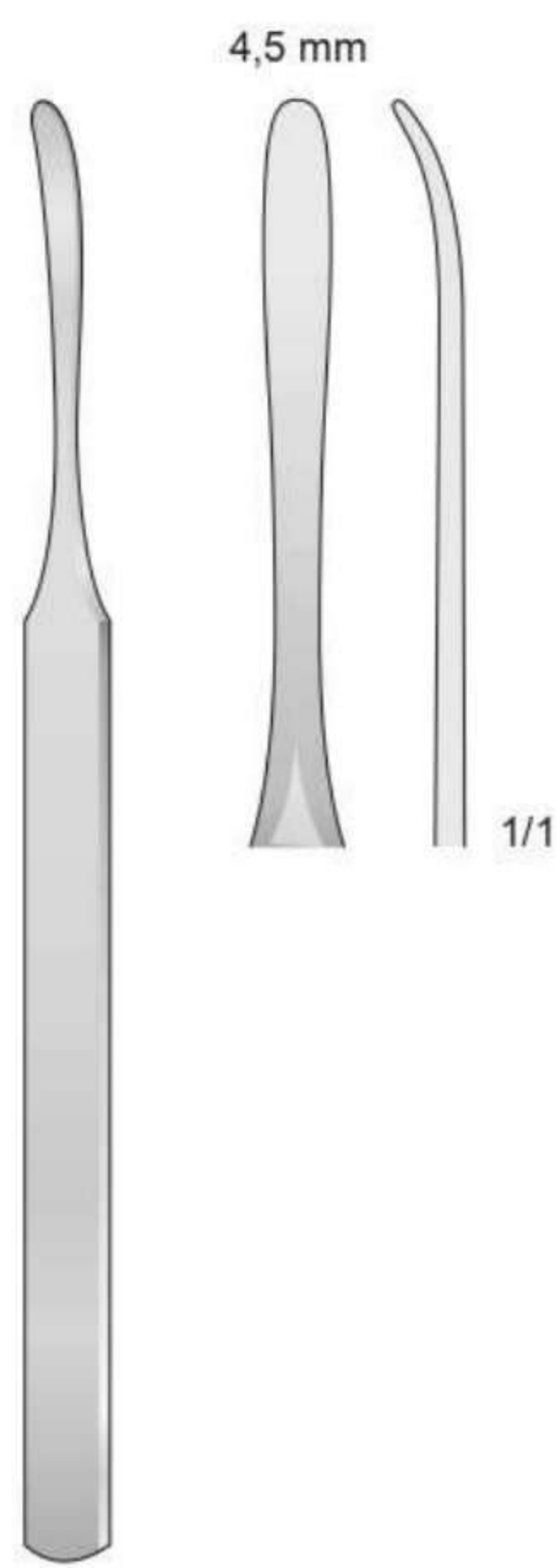

KÖNIG
KO-1
155 mm

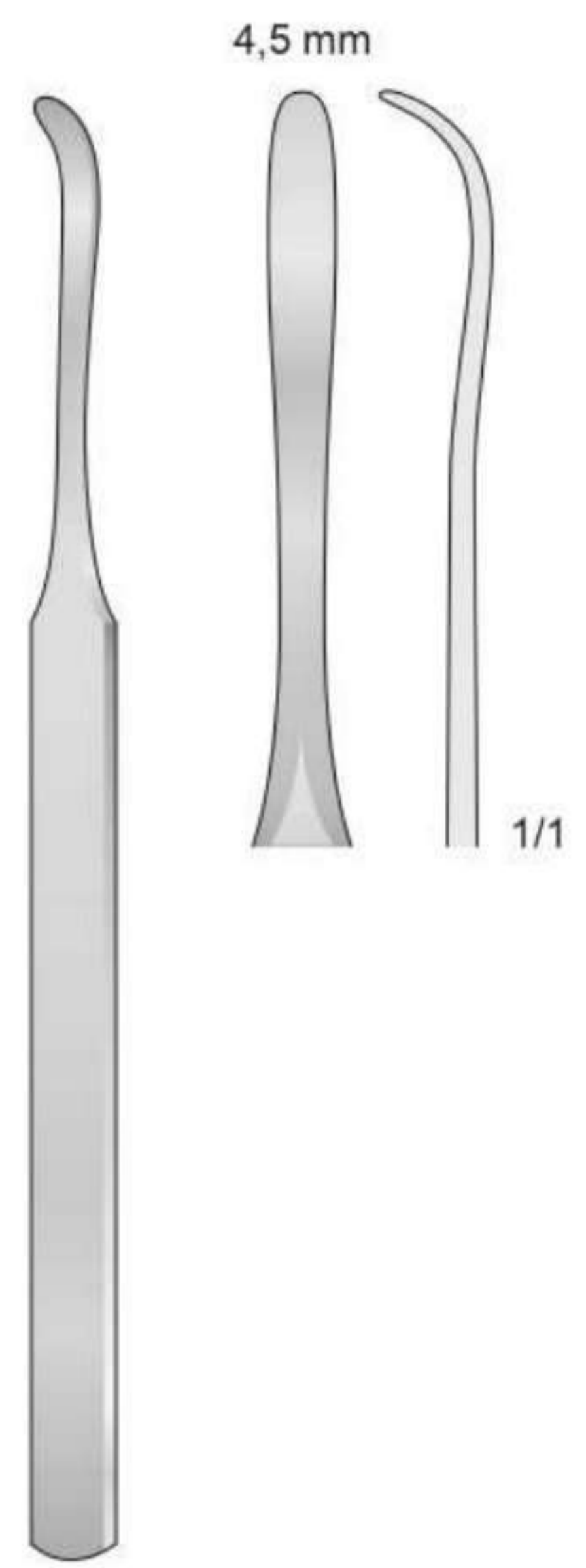

KÖNIG
KO-2
155 mm

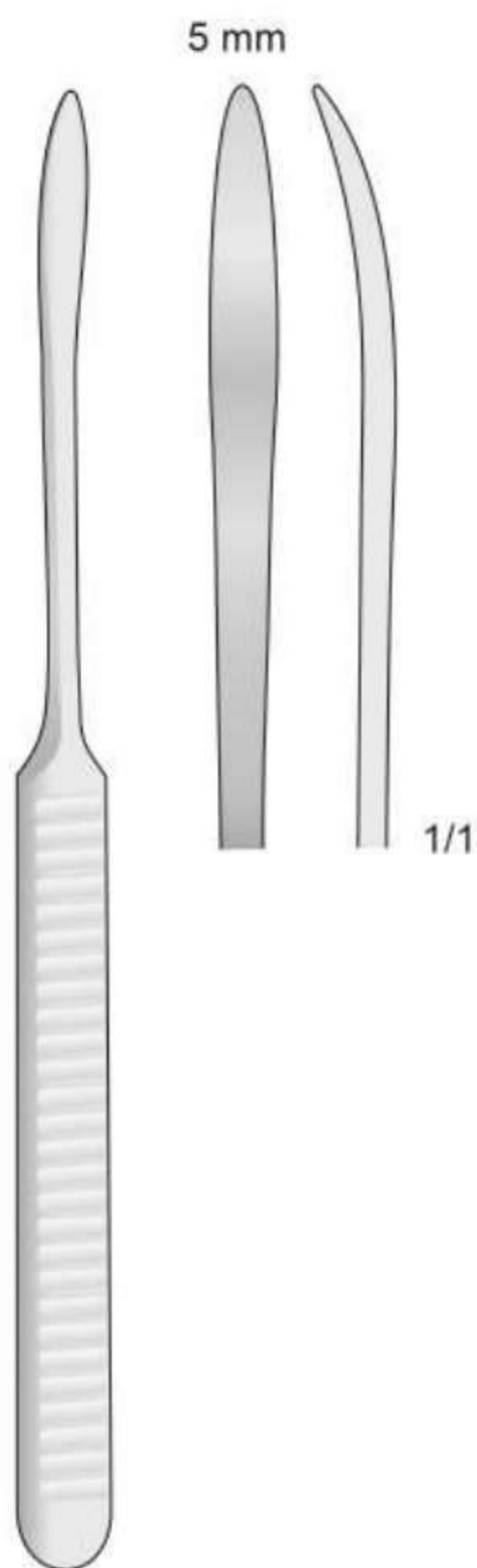

WILLIGER
WG-10
165 mm

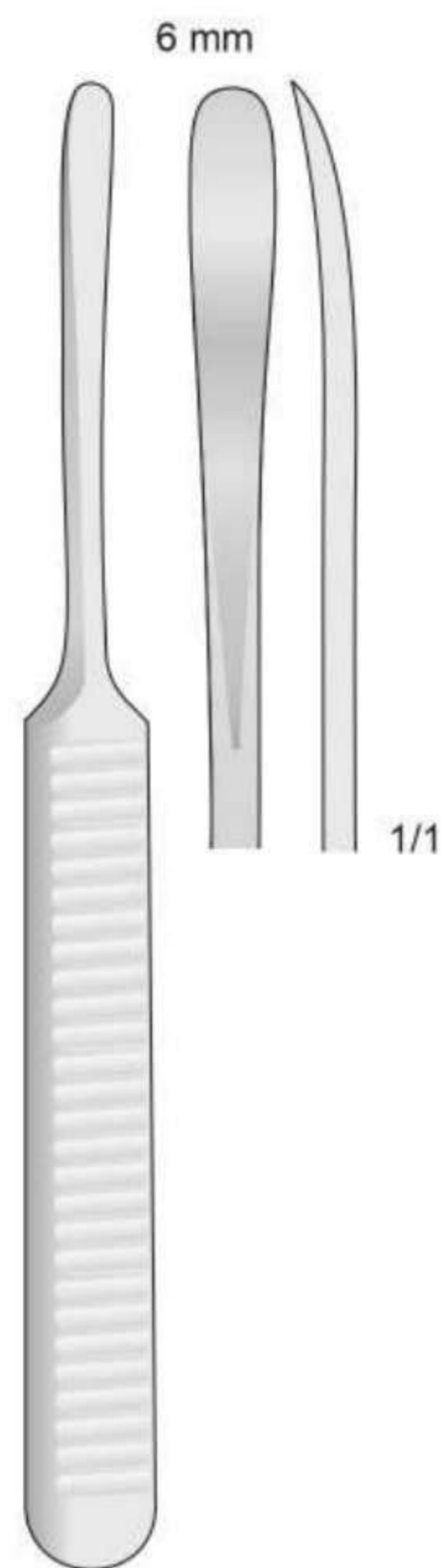

WILLIGER
WG-12
160 mm

Raspatorien
Periosteal Raspatories
Periostotomi
Legras periostotomos
Rugines à périostomie

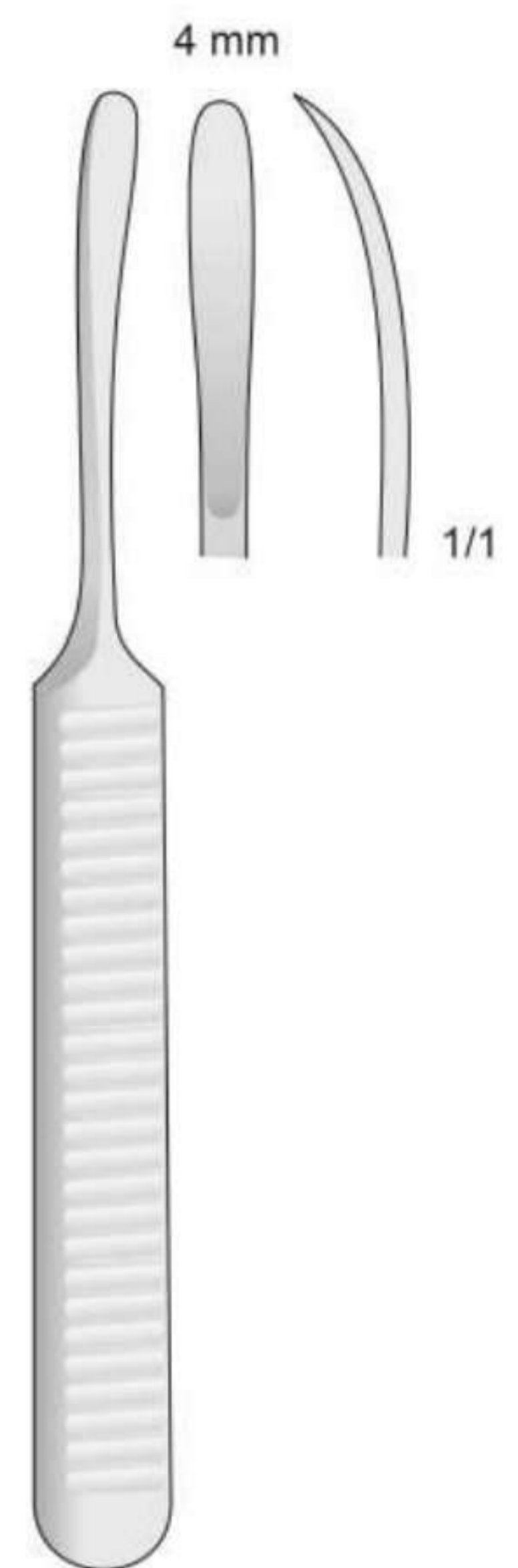

WILLIGER
WG-14
140 mm

Elevatorien

Elevators

Elevatori

Elevadores

Élévateurs

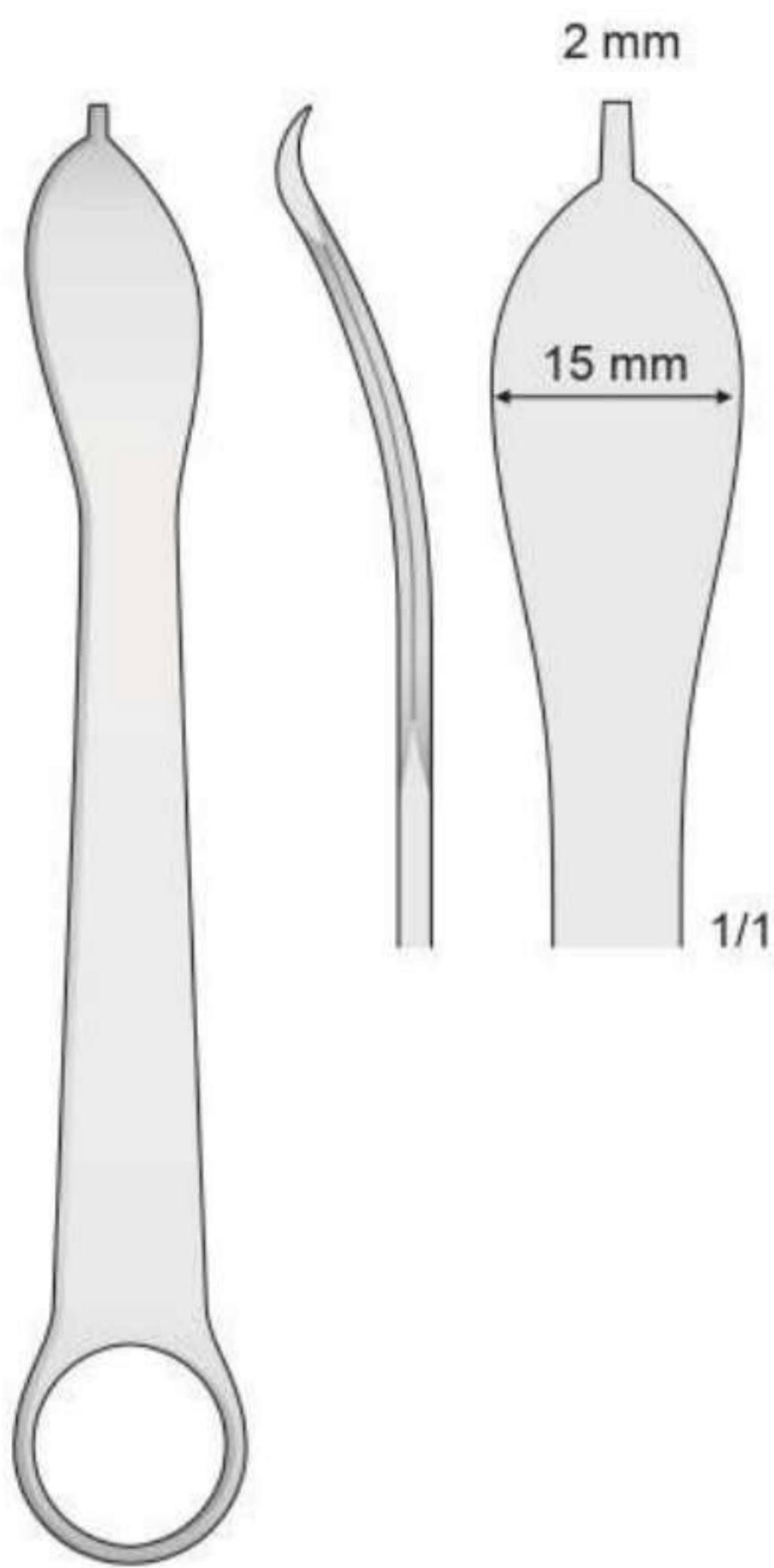

FK-45
120 mm

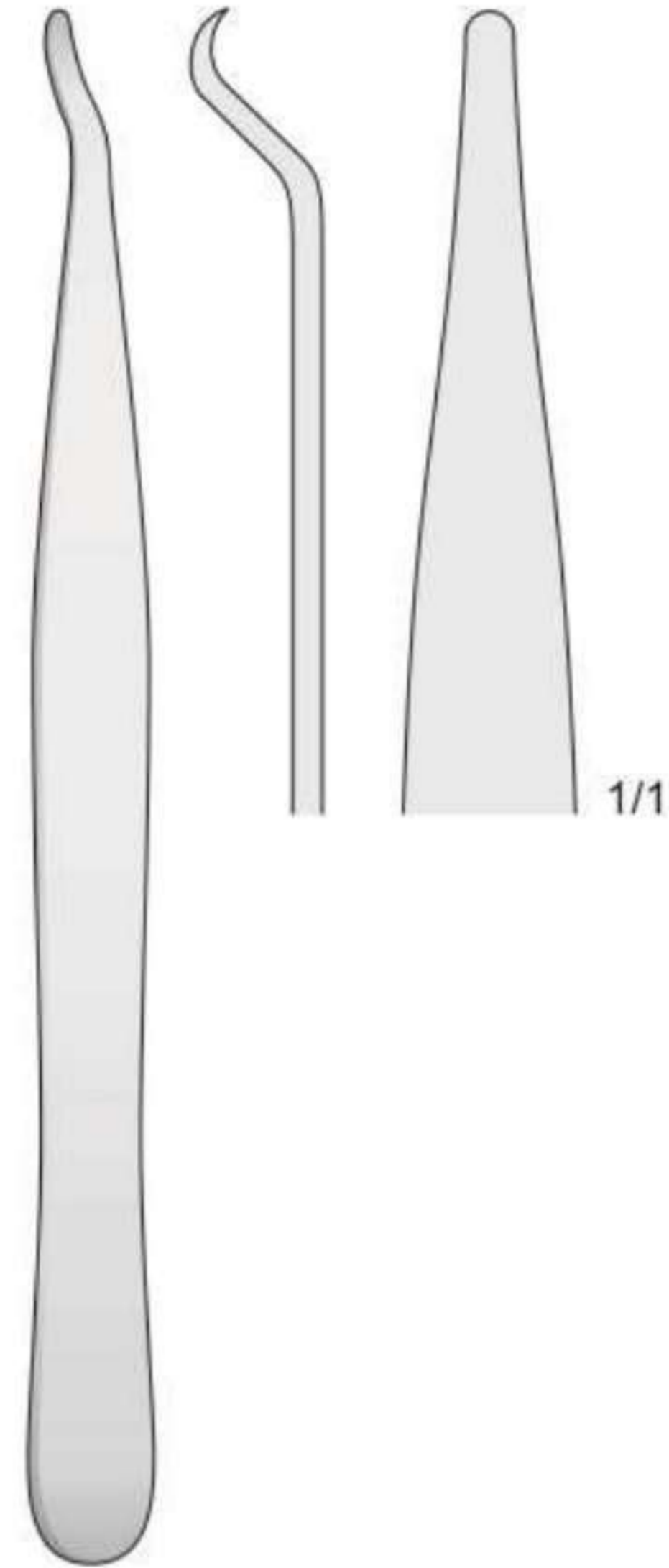

FK-46
140 mm

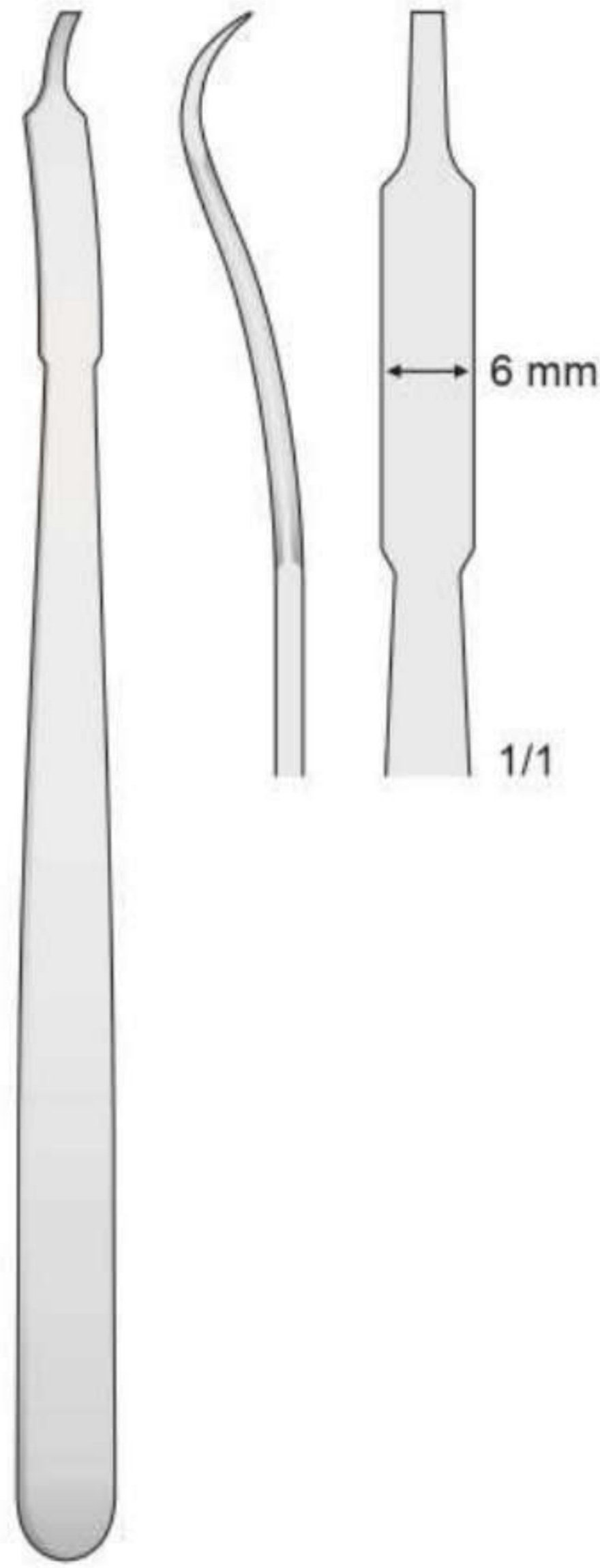

MINI-HOHMANN
FK-48
160 mm

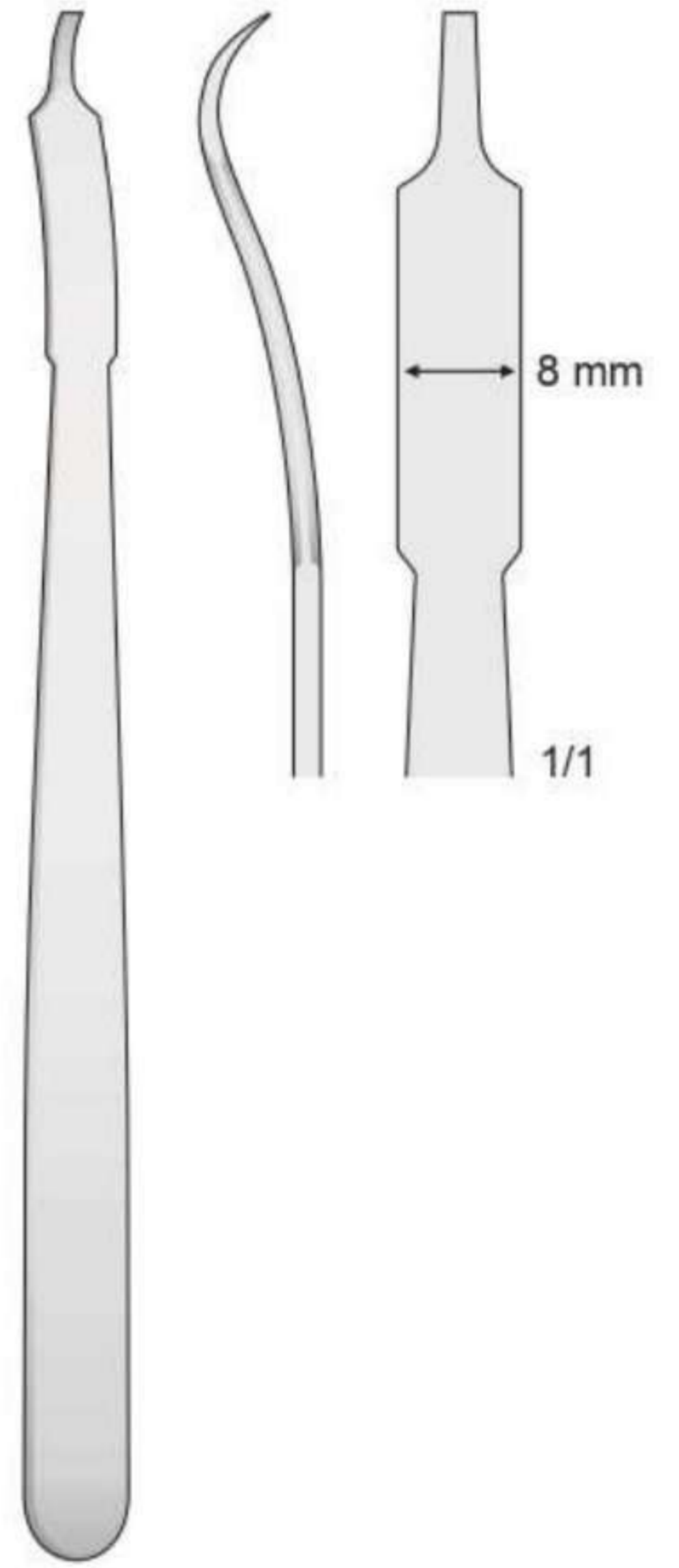

MINI-HOHMANN
FK-49
160 mm

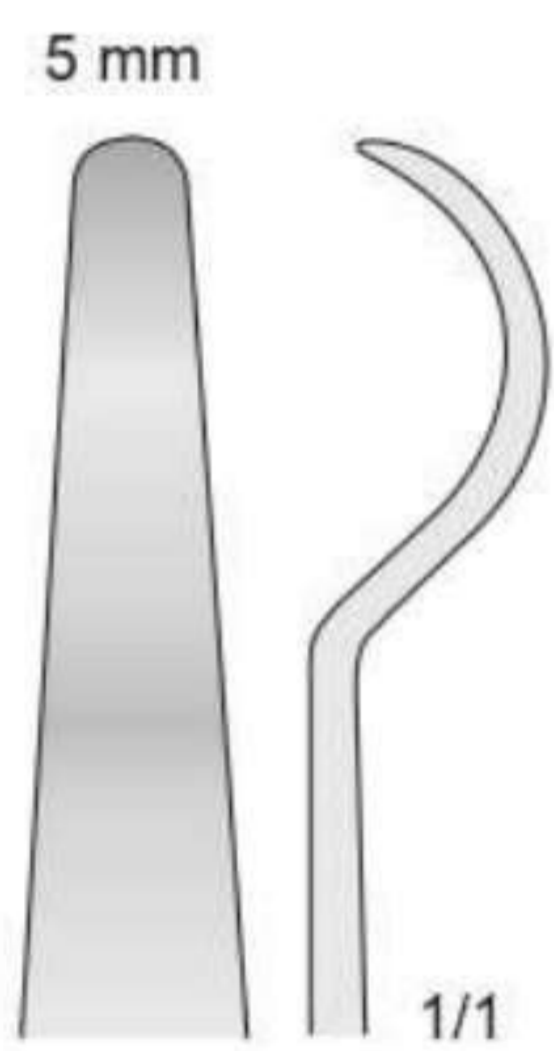

FK-30
150 mm

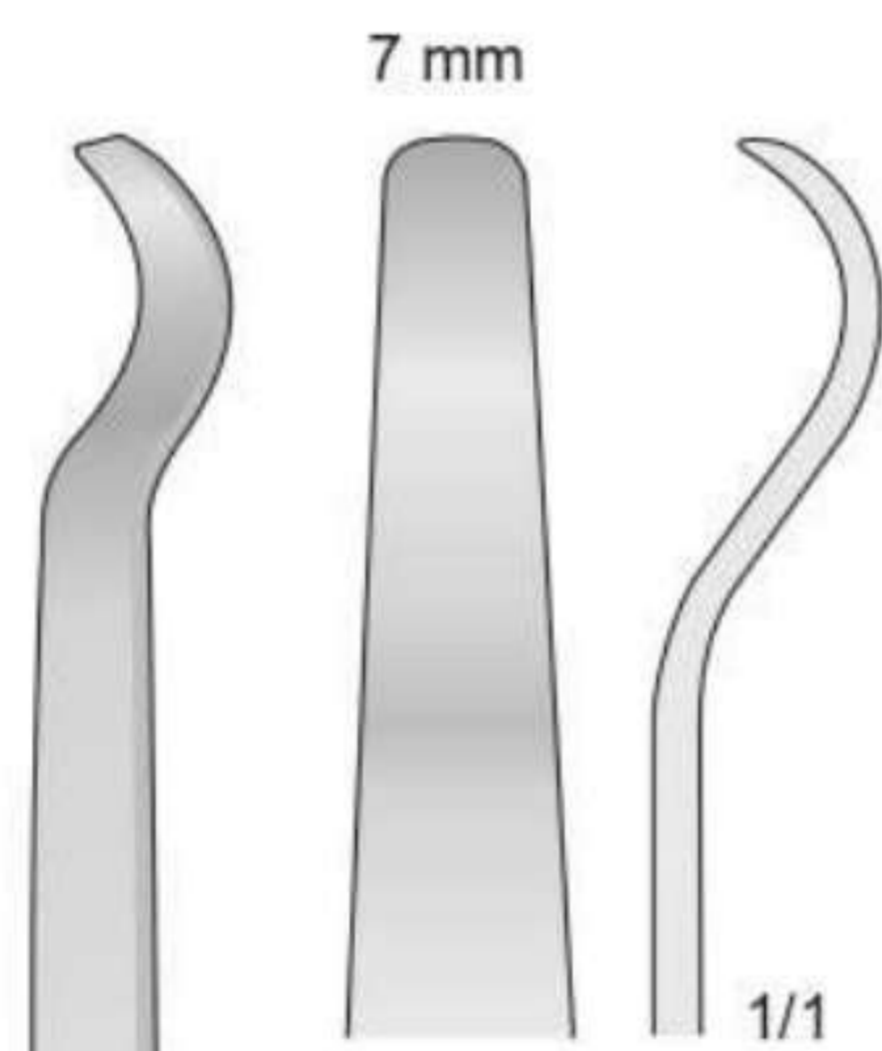

FK-28
150 mm

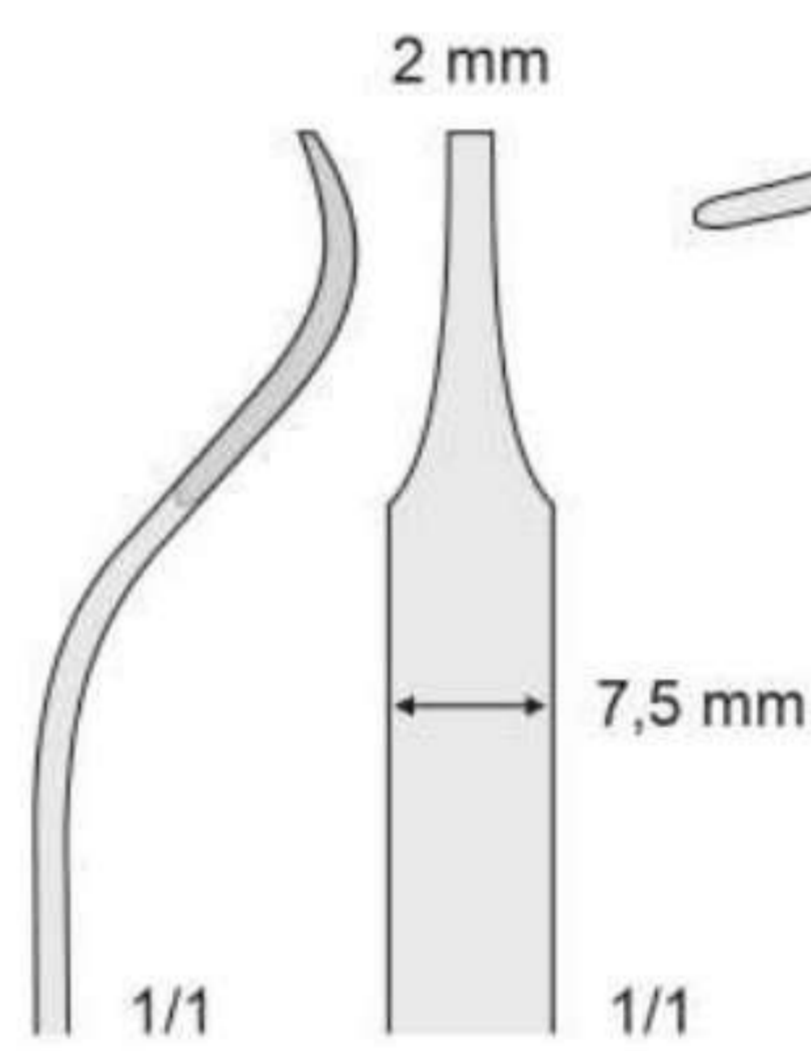

BUCK-GRAMCKO
FK-20
150 mm

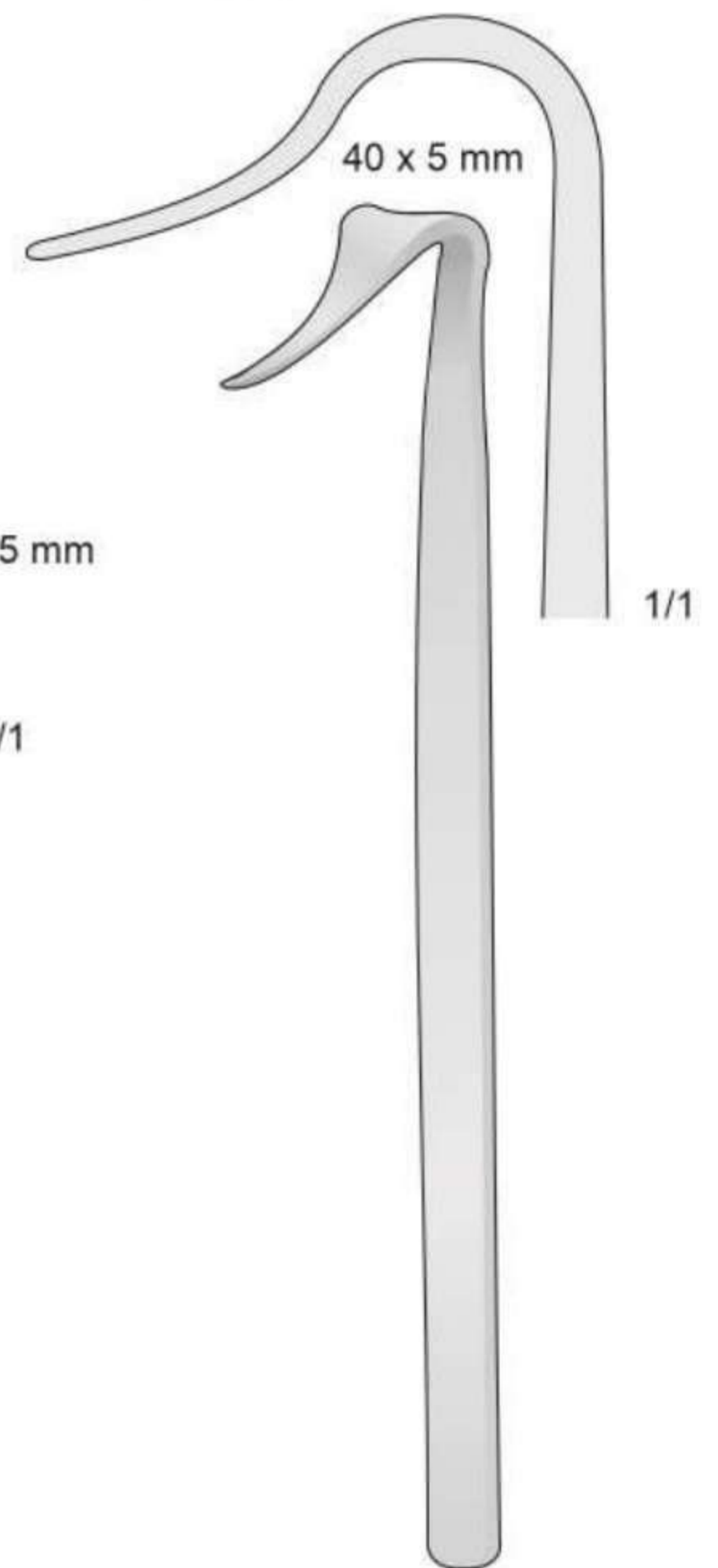

BLOUNT
FK-27
175 mm

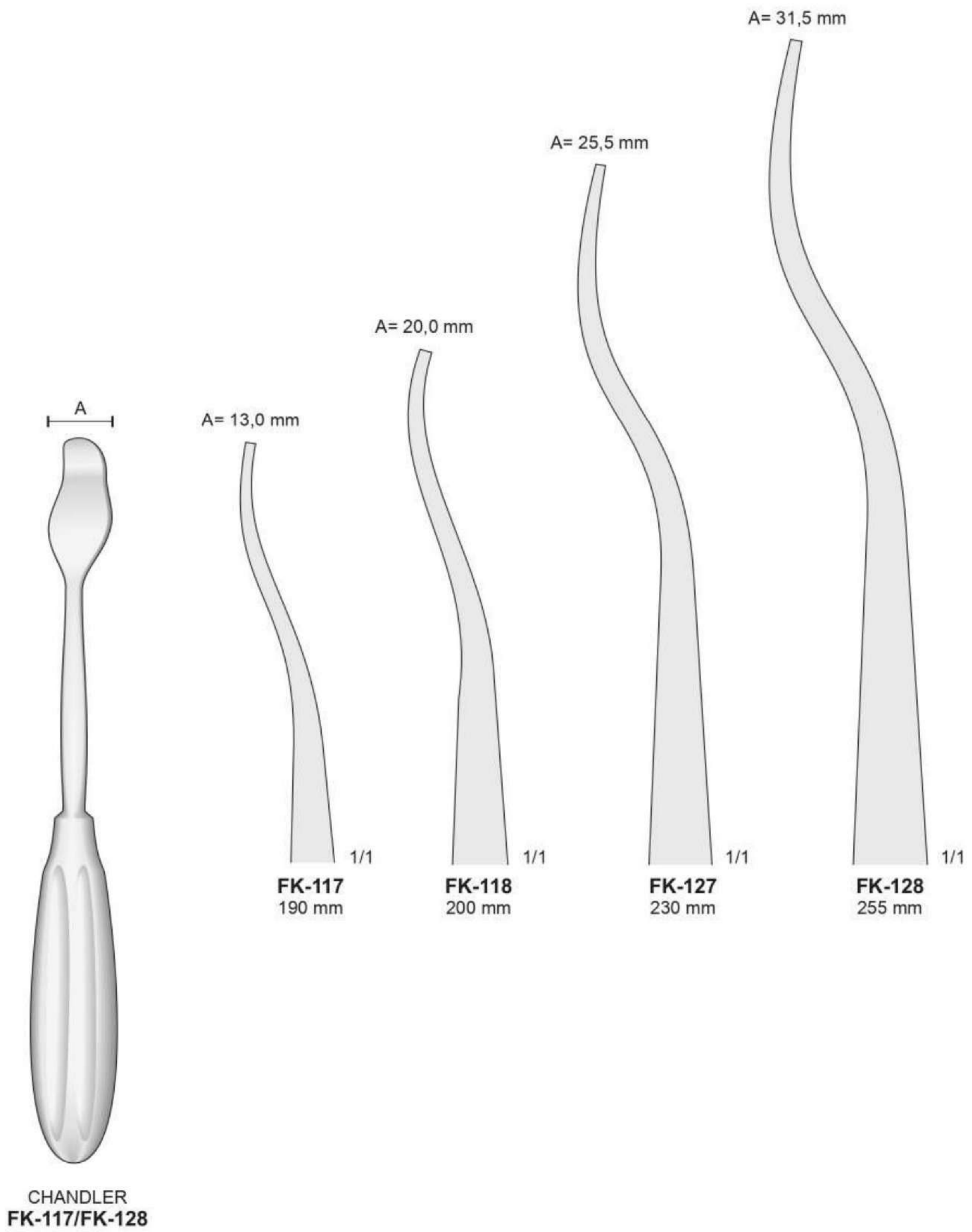

Elevatorien

Elevators

Elevatori

Elevadores

Élévateurs

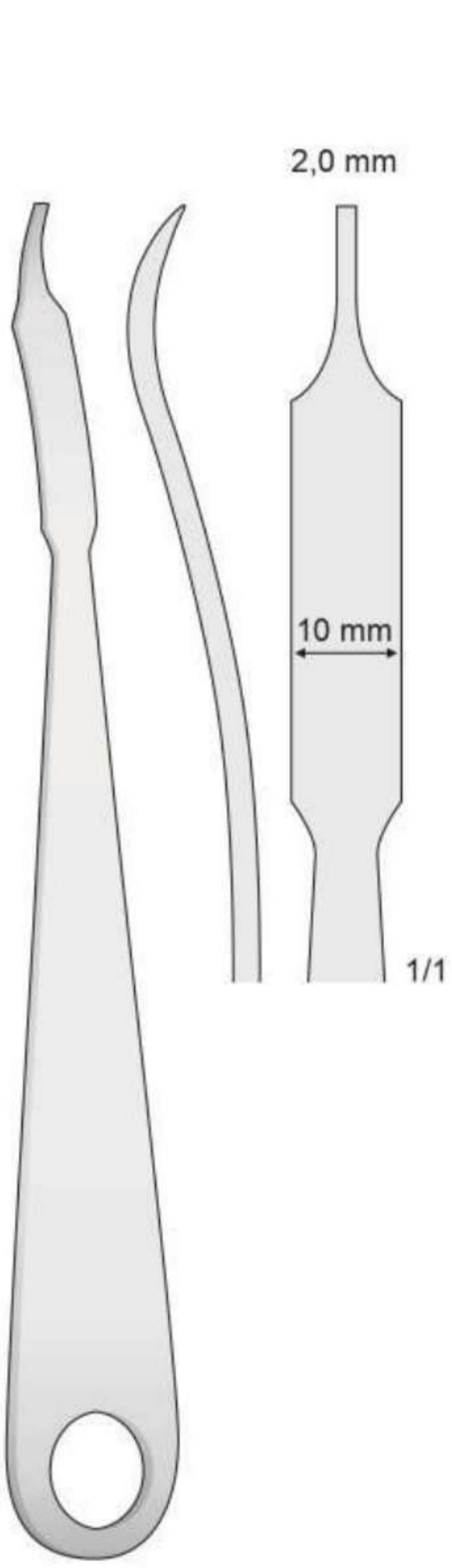

FK-51
220 mm

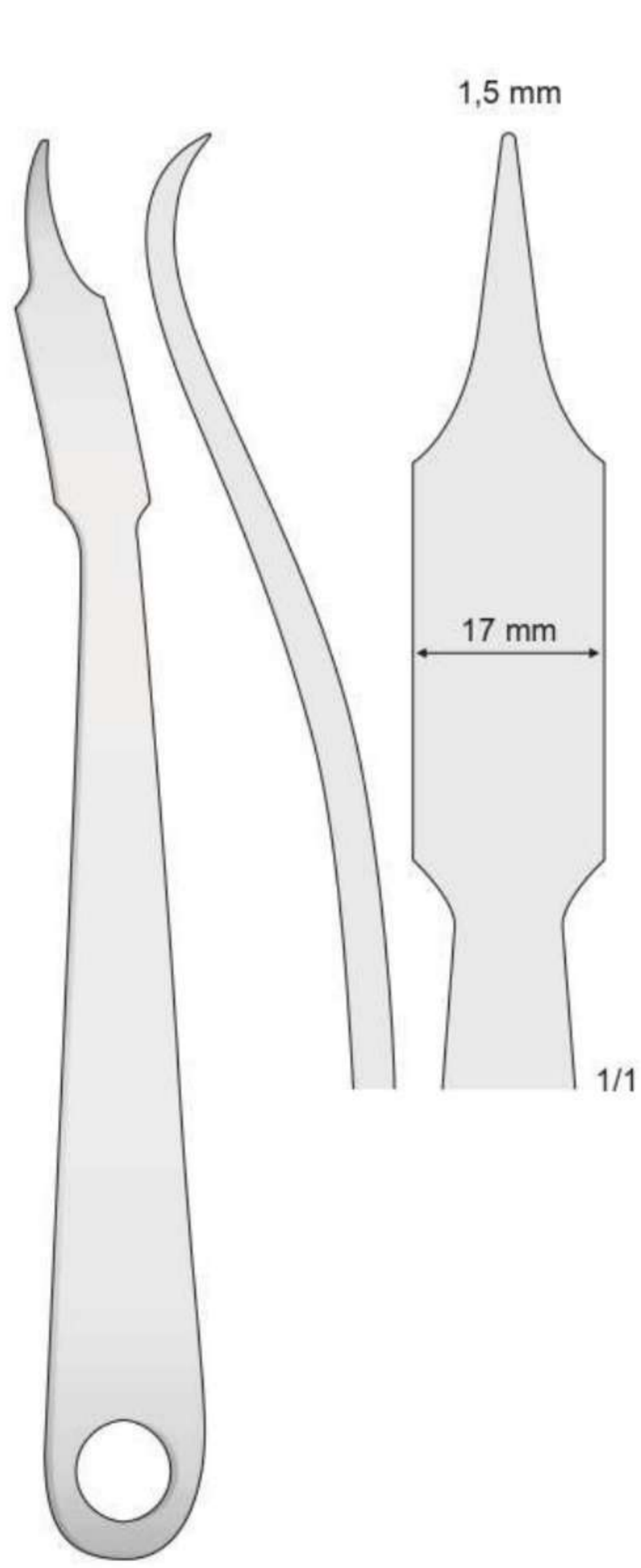

FK-52
240 mm

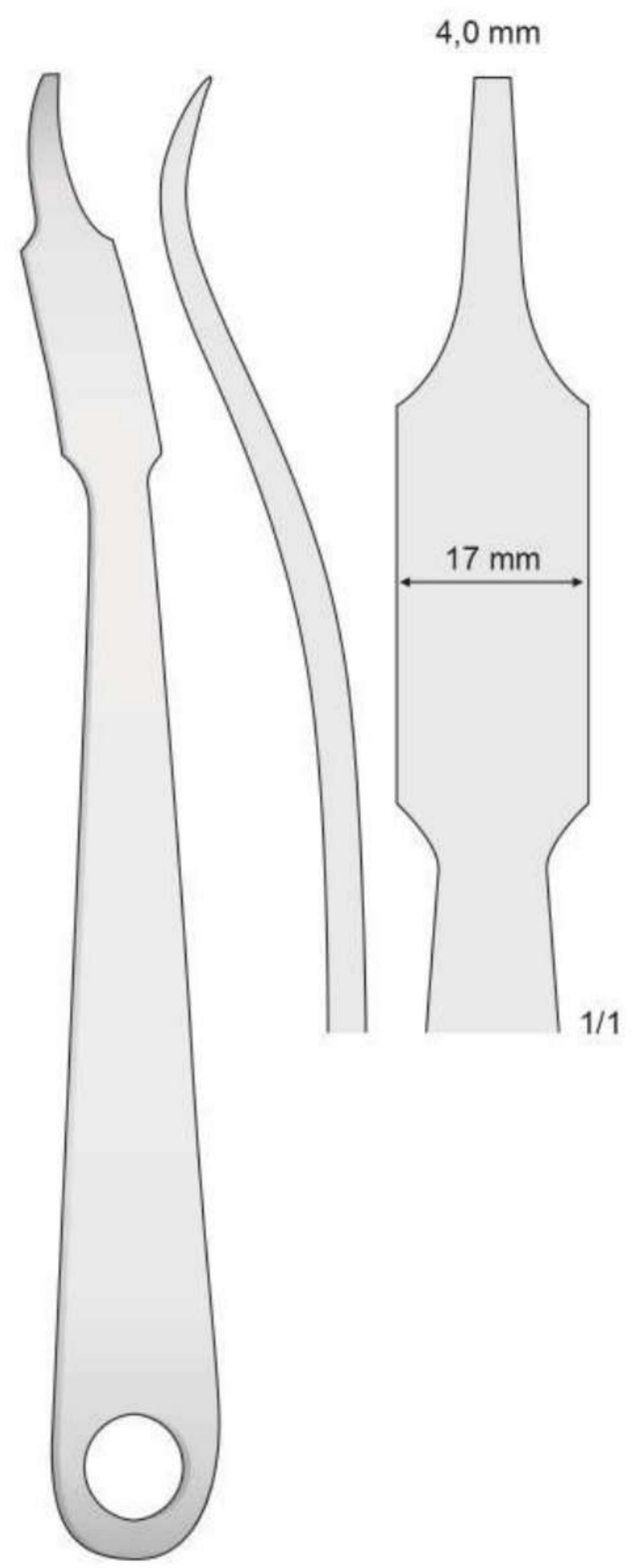

FK-53
240 mm

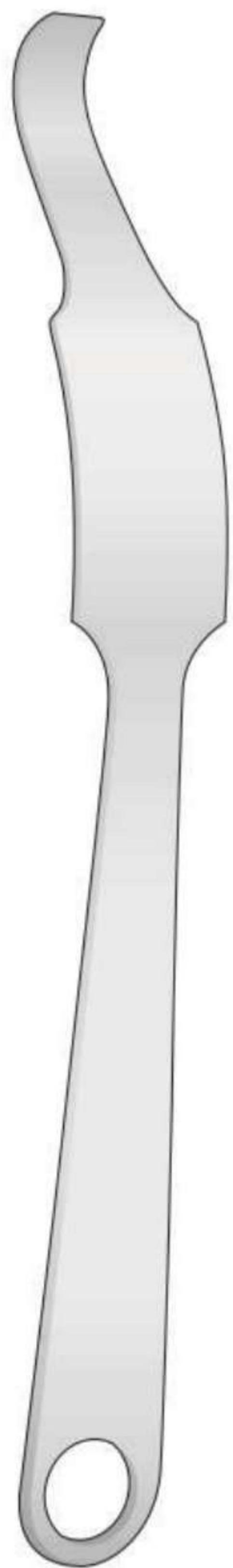

HOHMANN
FK-54/FK-55



FK-54
260 mm

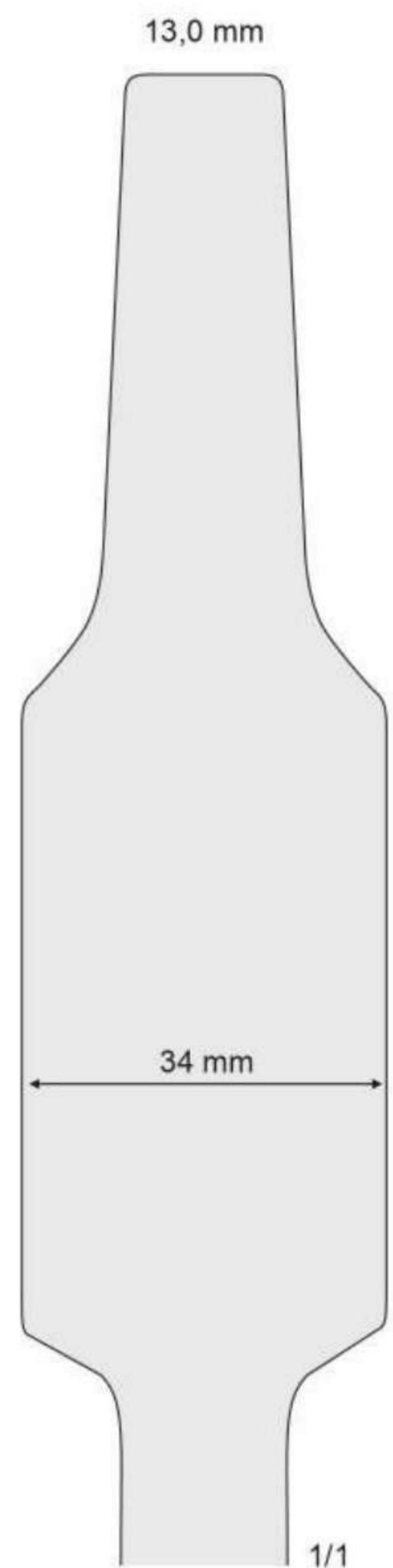

FK-55
285 mm

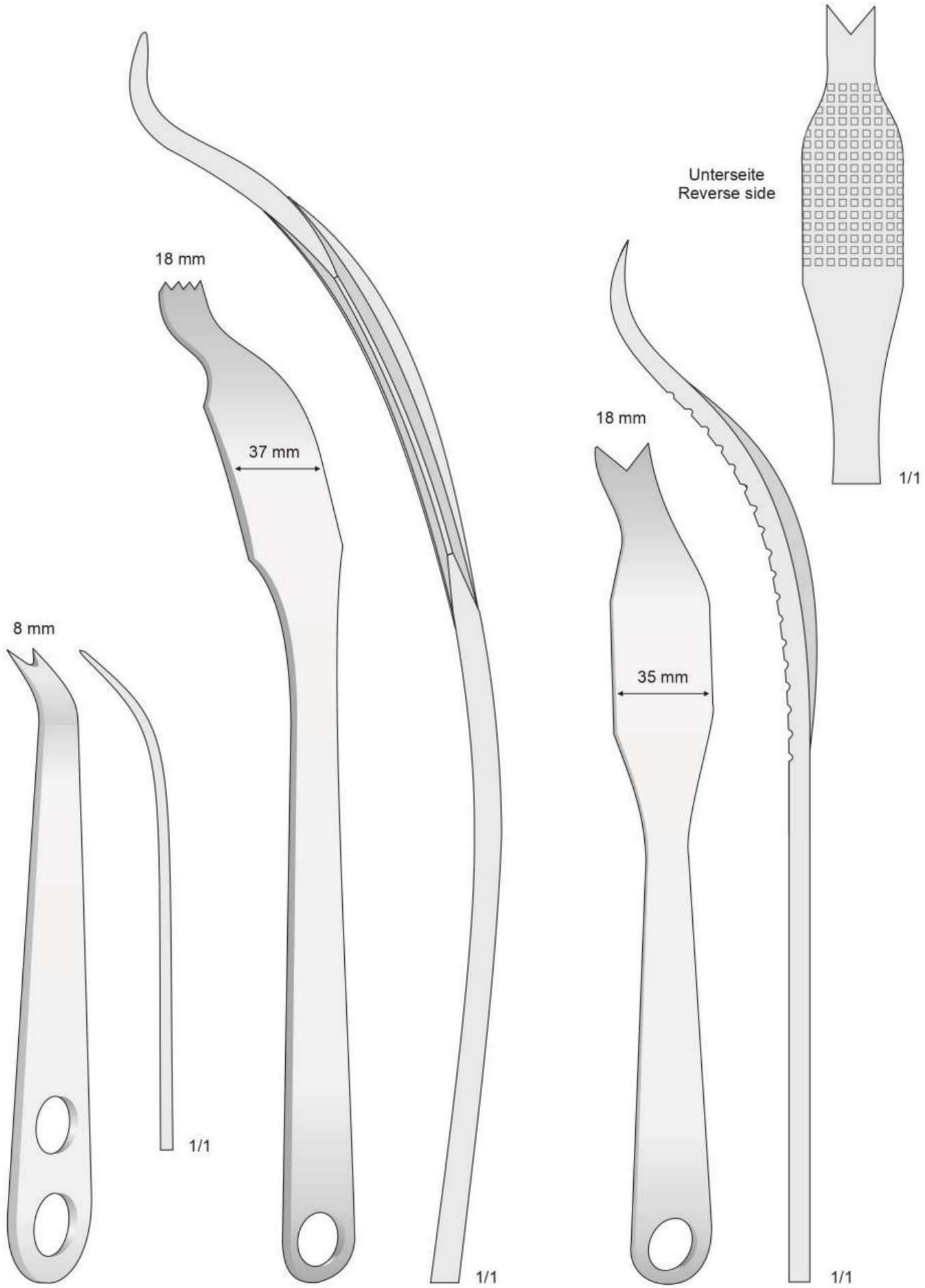

FK-81
140 mm

SCHUMACHER mod. WAGNER
FK-58
345 mm

SCHUMACHER
FK-59
285 mm

Elevatori

Elevators

Elevatori

Elevadores

Élévateurs

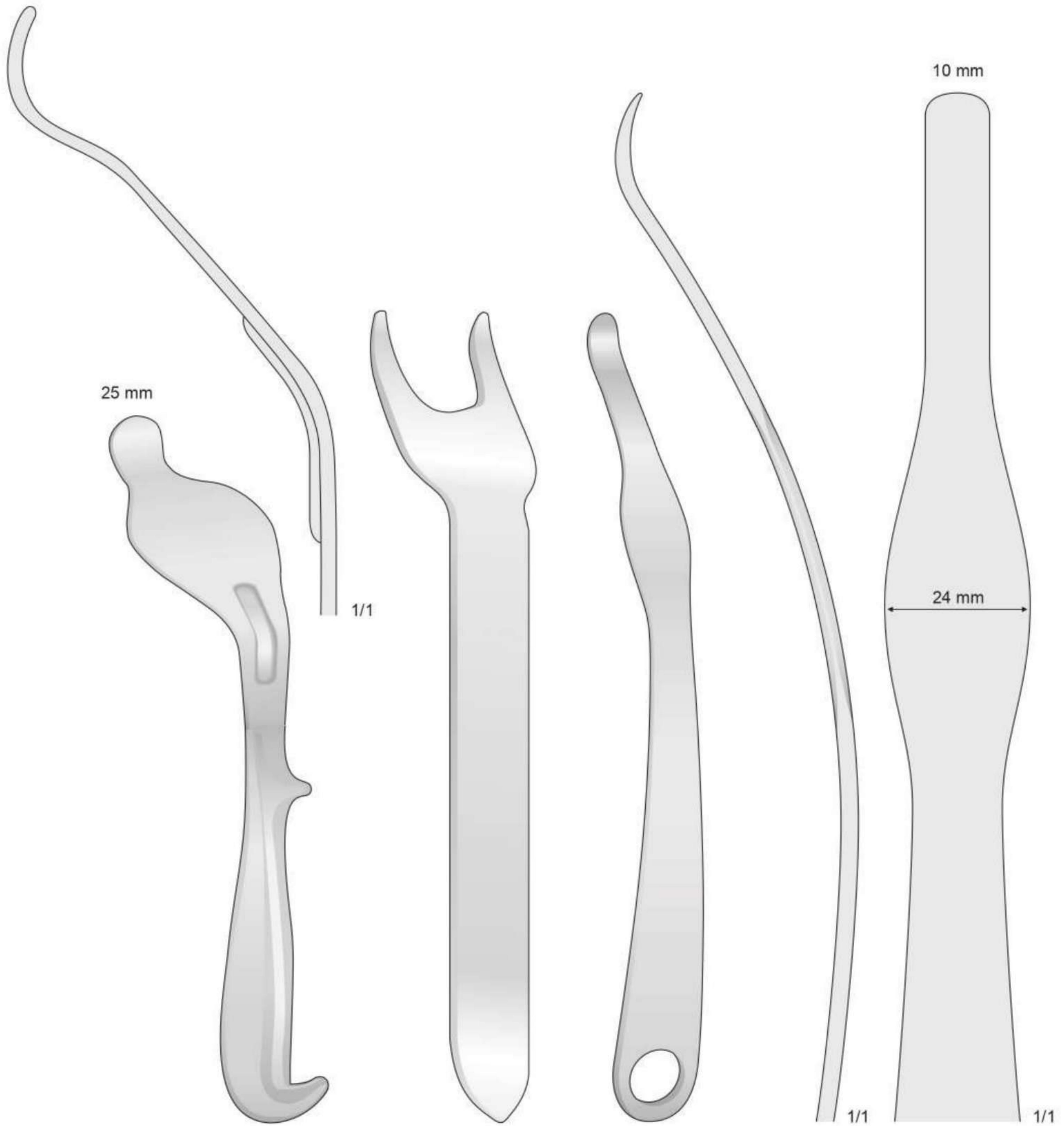

BENNETT
FK-176 43 mm
FK-179 60 mm
240 mm

BLOUNT
FK-93
260 mm

FK-56
260 mm

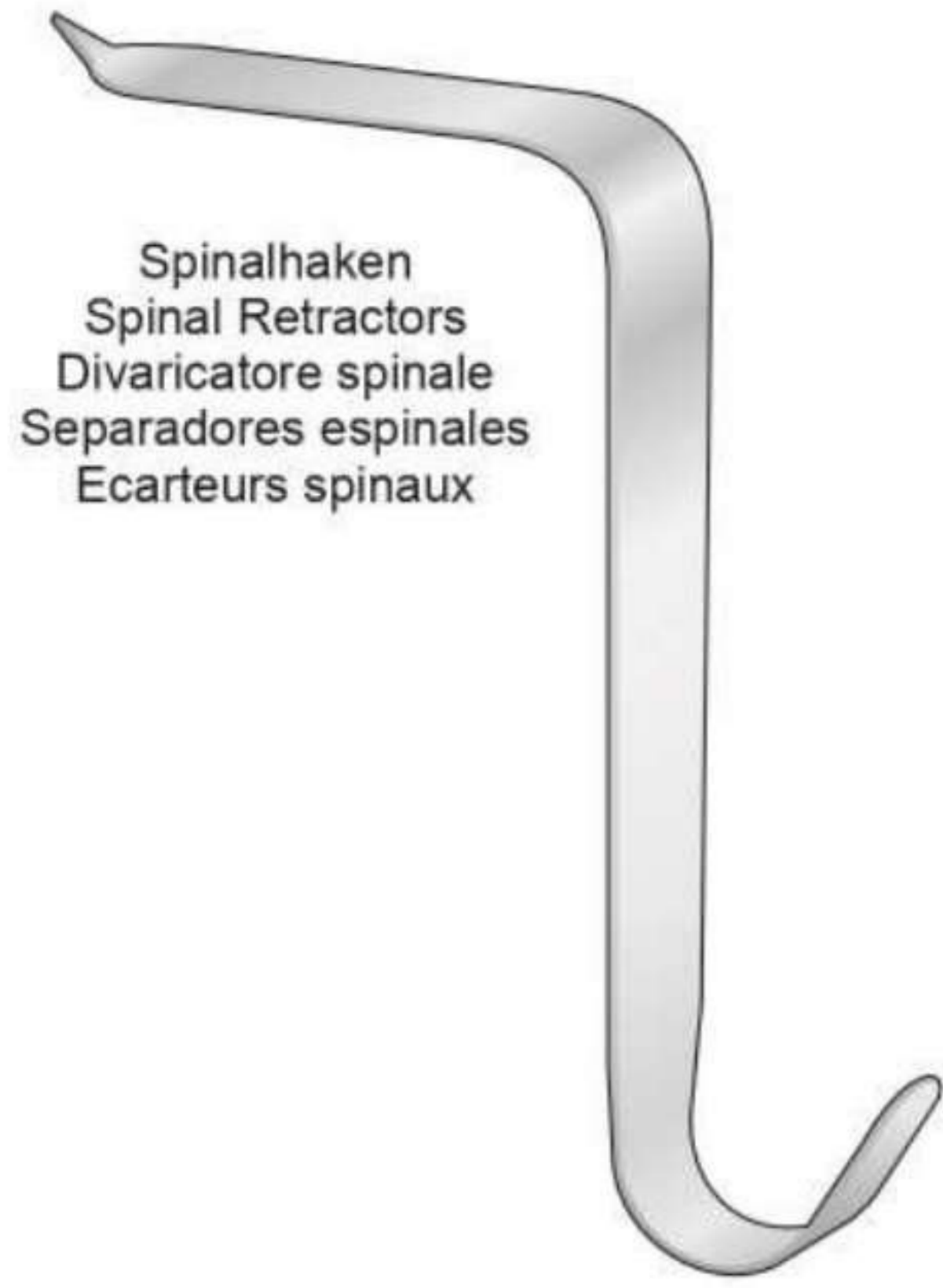

Spinalhaken
 Spinal Retractors
 Divaricatore spinale
 Separadores espinales
 Ecarteurs spinaux

TAYLOR
 FK-168 75 x 30 mm
 FK-169 100 x 30 mm
 165 mm

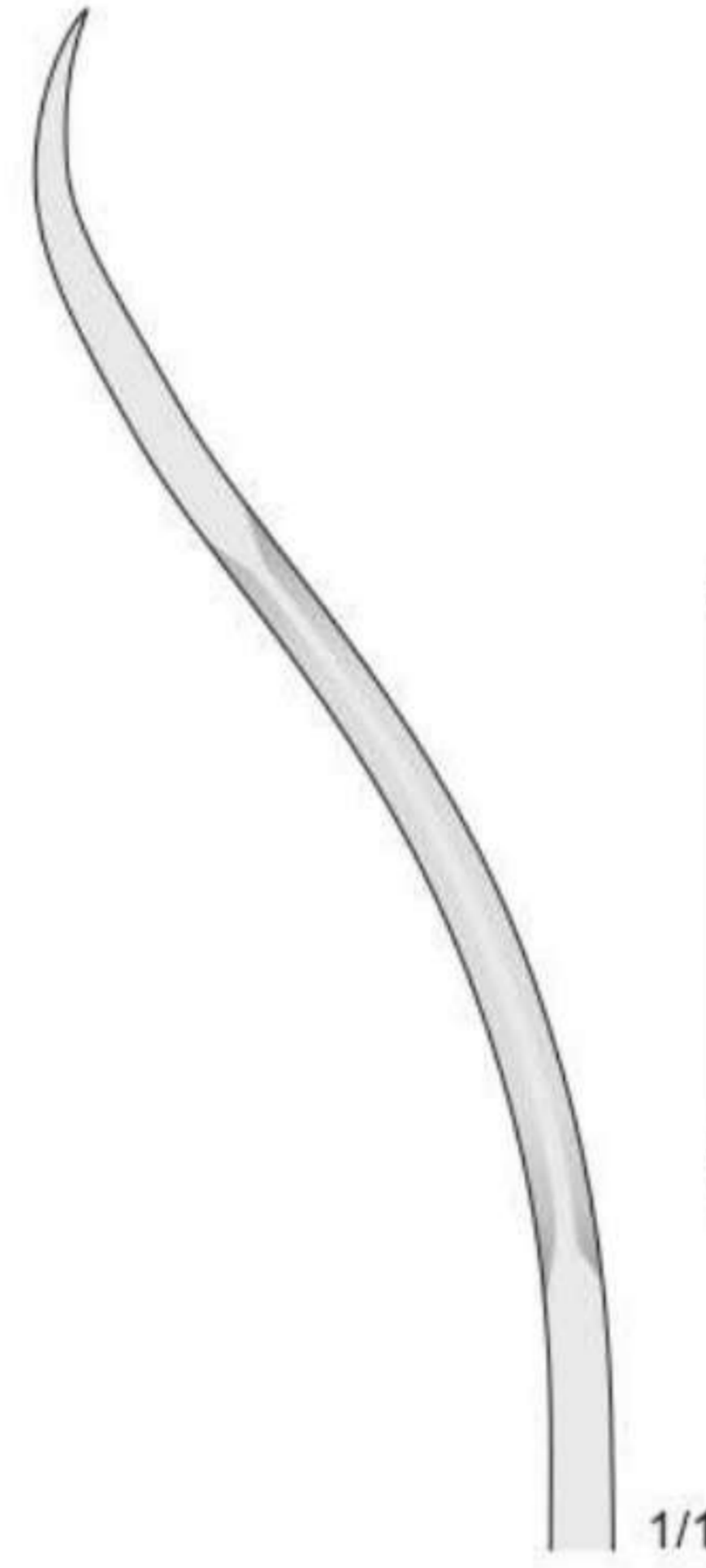

1/1

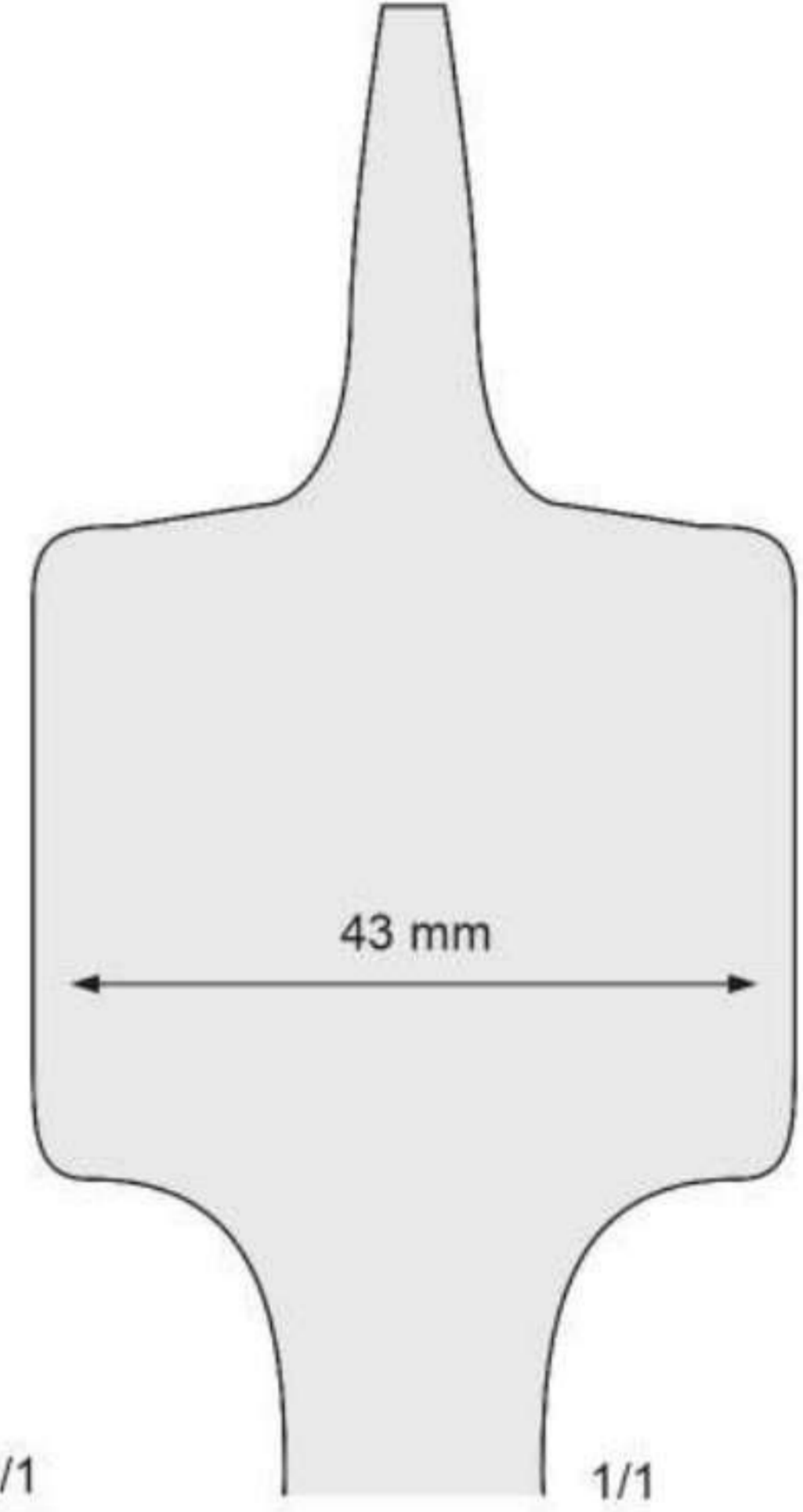

43 mm

1/1

FK-57
 240 mm



FK-164
 250 mm

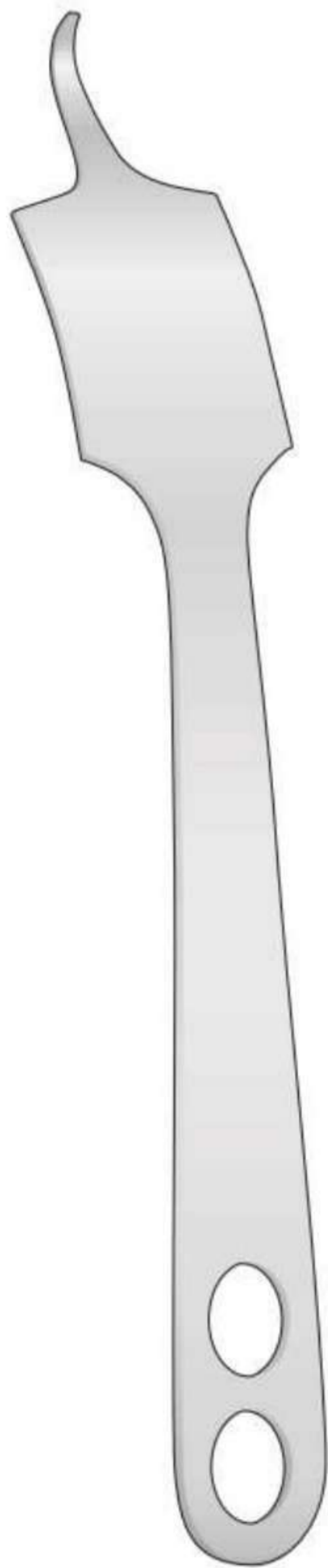

HOHMANN
 FK-47/FK-57
 240 mm

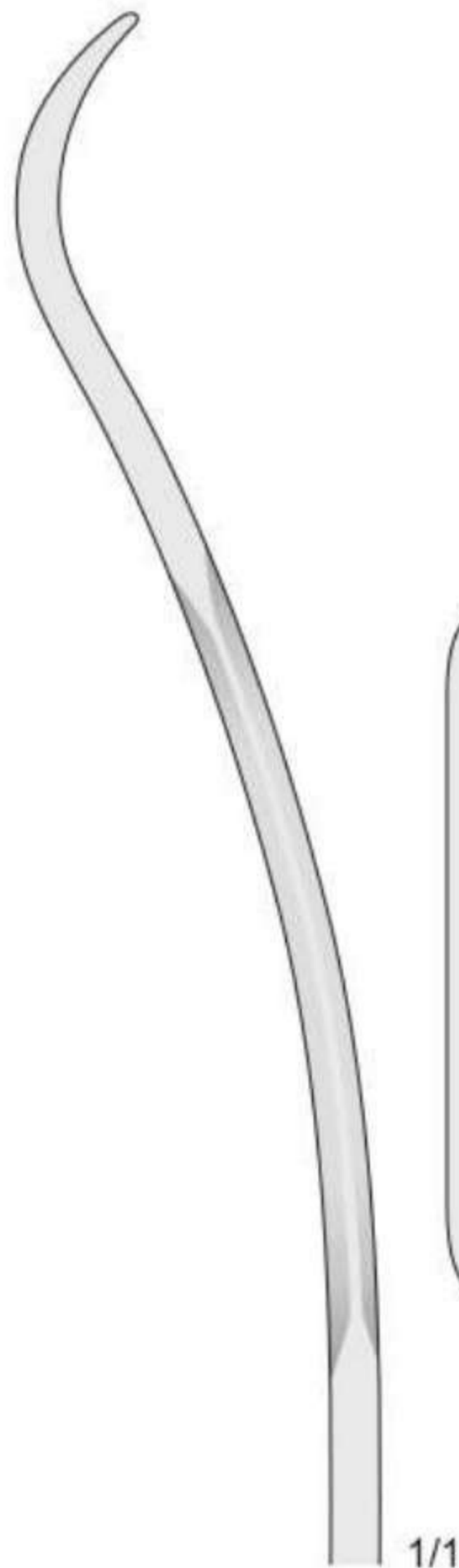

1/1

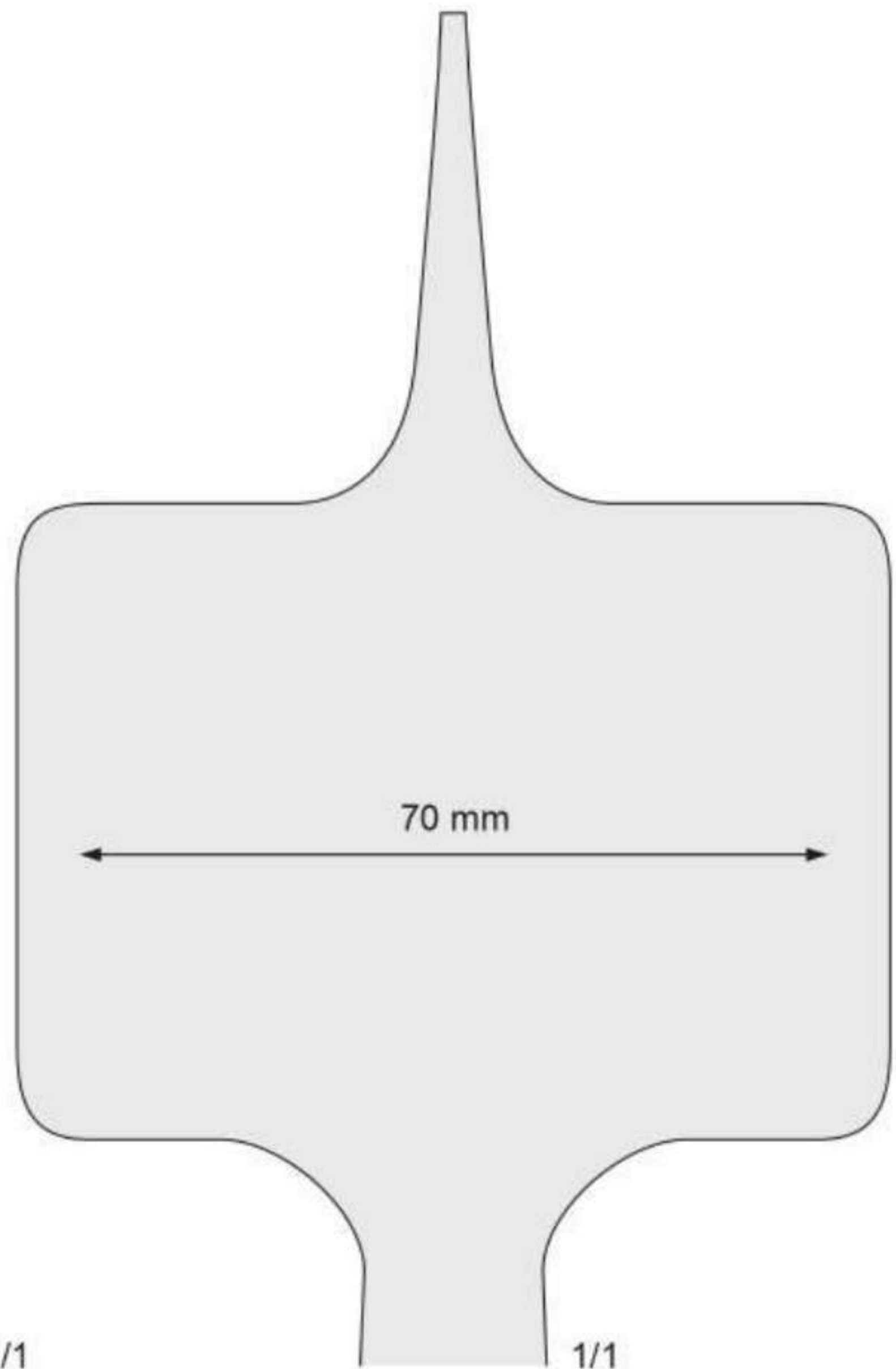

70 mm

1/1

FK-47
 240 mm

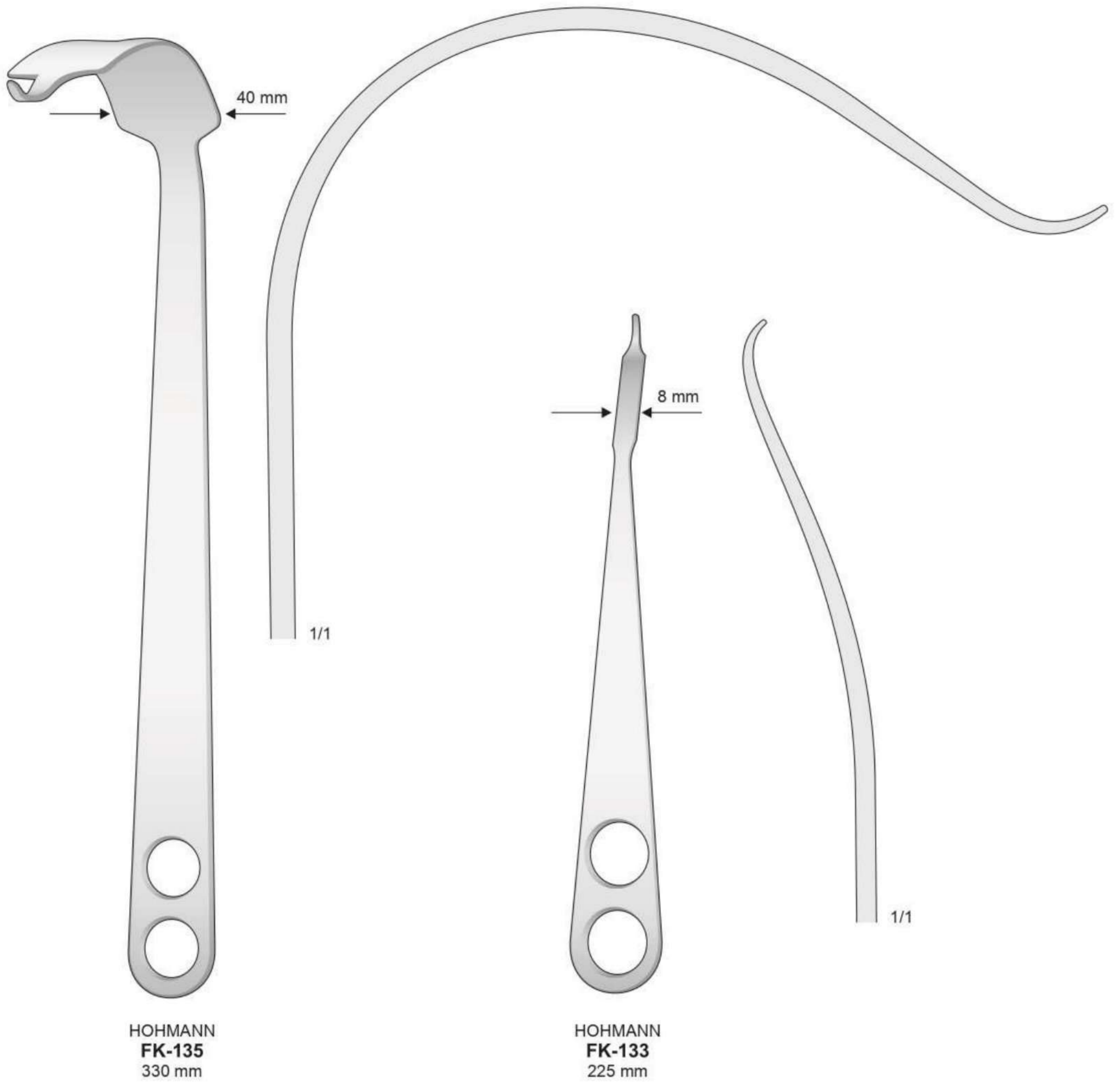

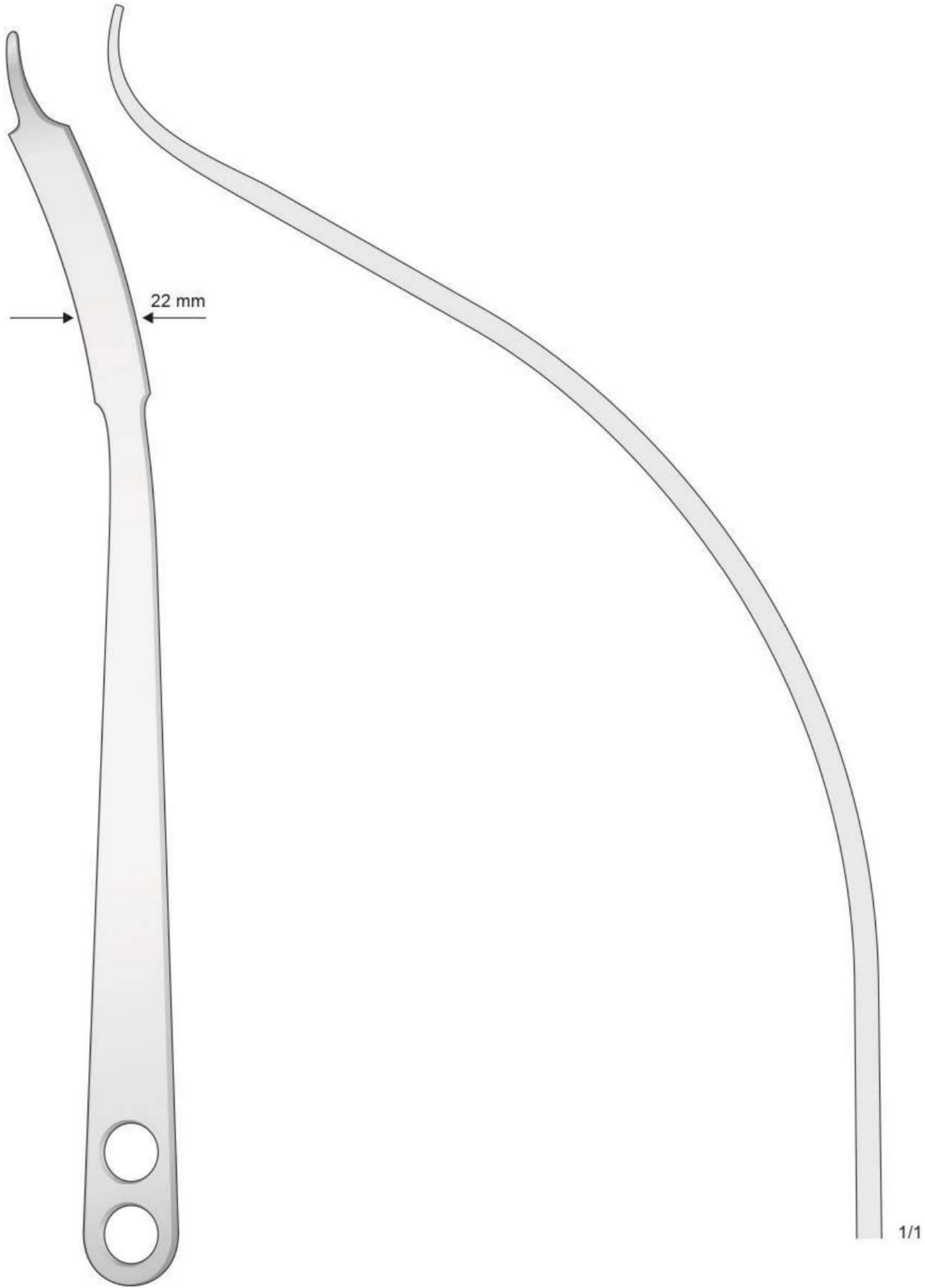

HOHMANN
FK-134
400 mm

Raspatorien

Periosteal Raspatories

Scollaperiosteo (Periostotomi)

Periostótomos (Legras)

Rugines périostiques

15 mm

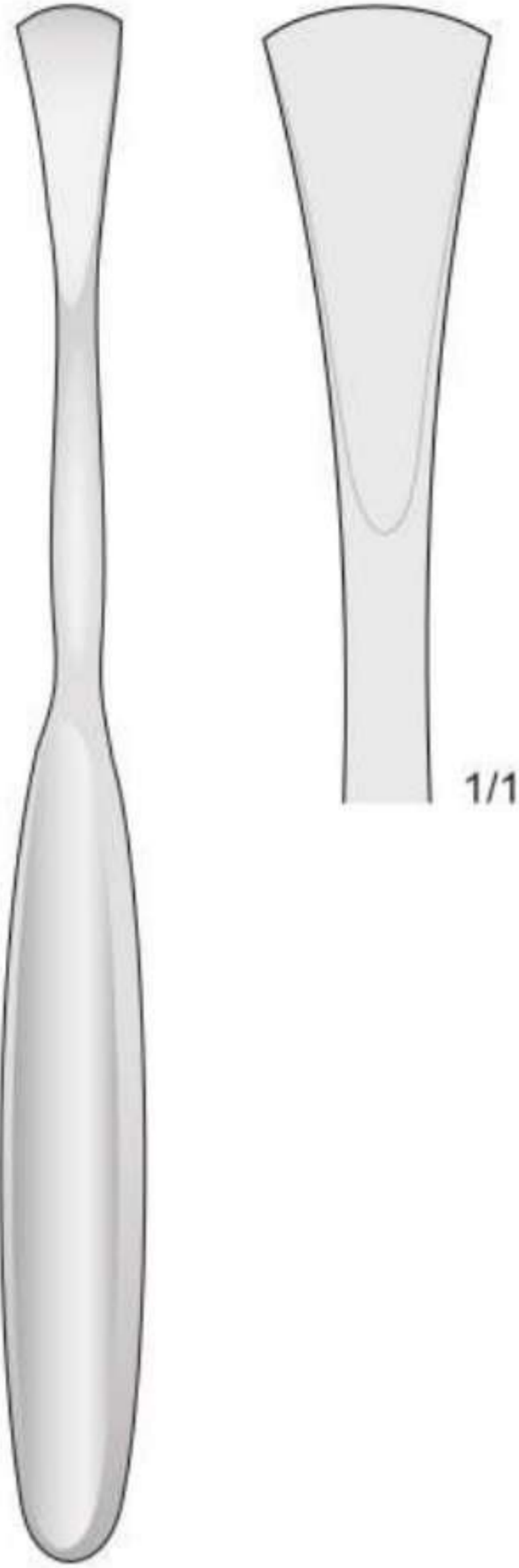

CUSHING
FK-252
190 mm

8 mm



ADSON
FK-260/FK-263
170 mm

7 mm



7 mm



7 mm



2,5 mm

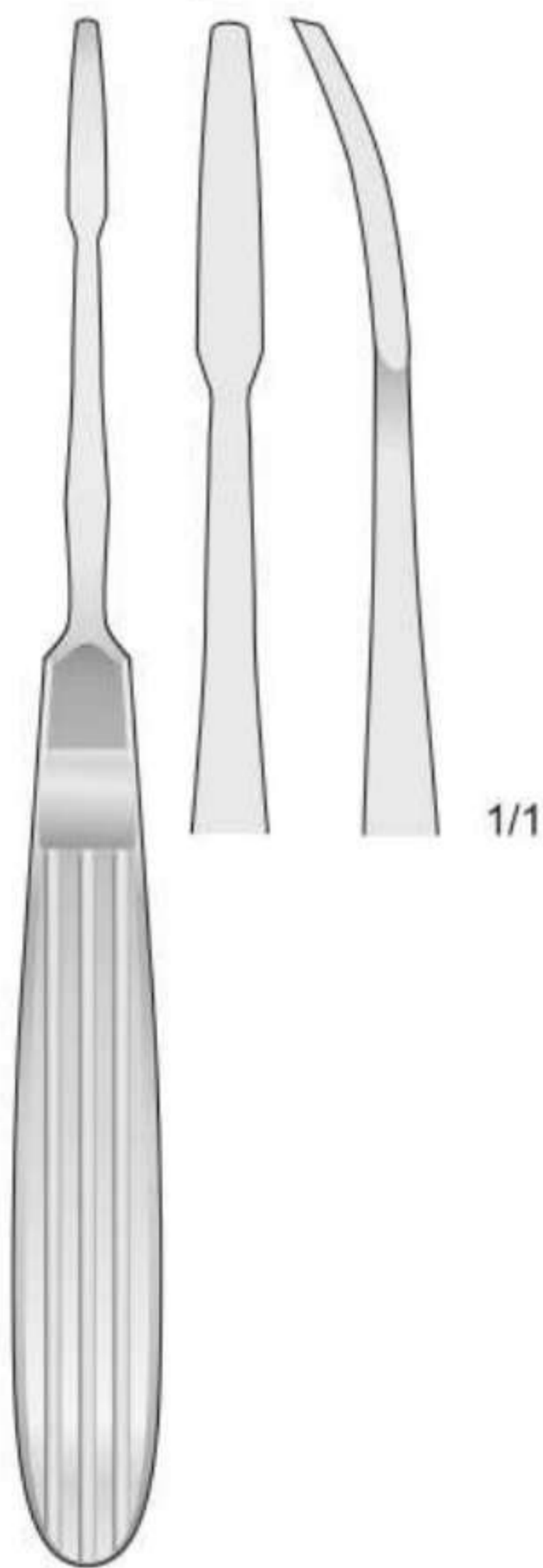

JOSEPH
FK-80
170 mm

4 mm

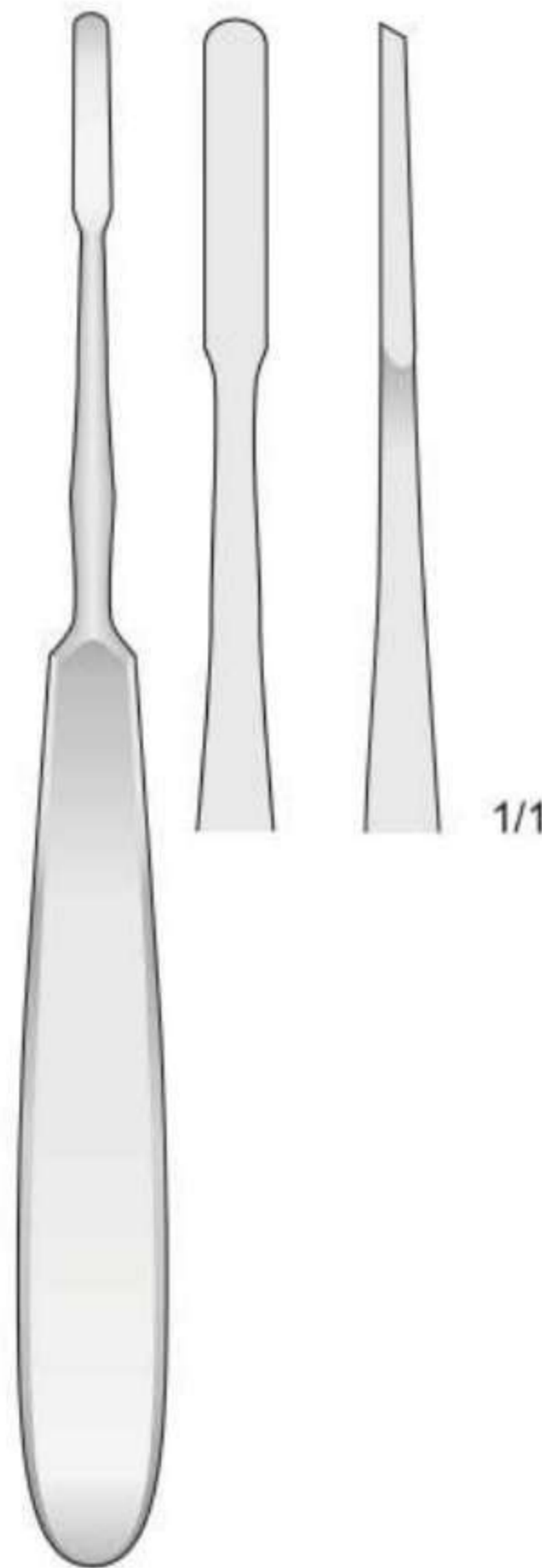

FOMON
FK-264
170 mm

4 mm

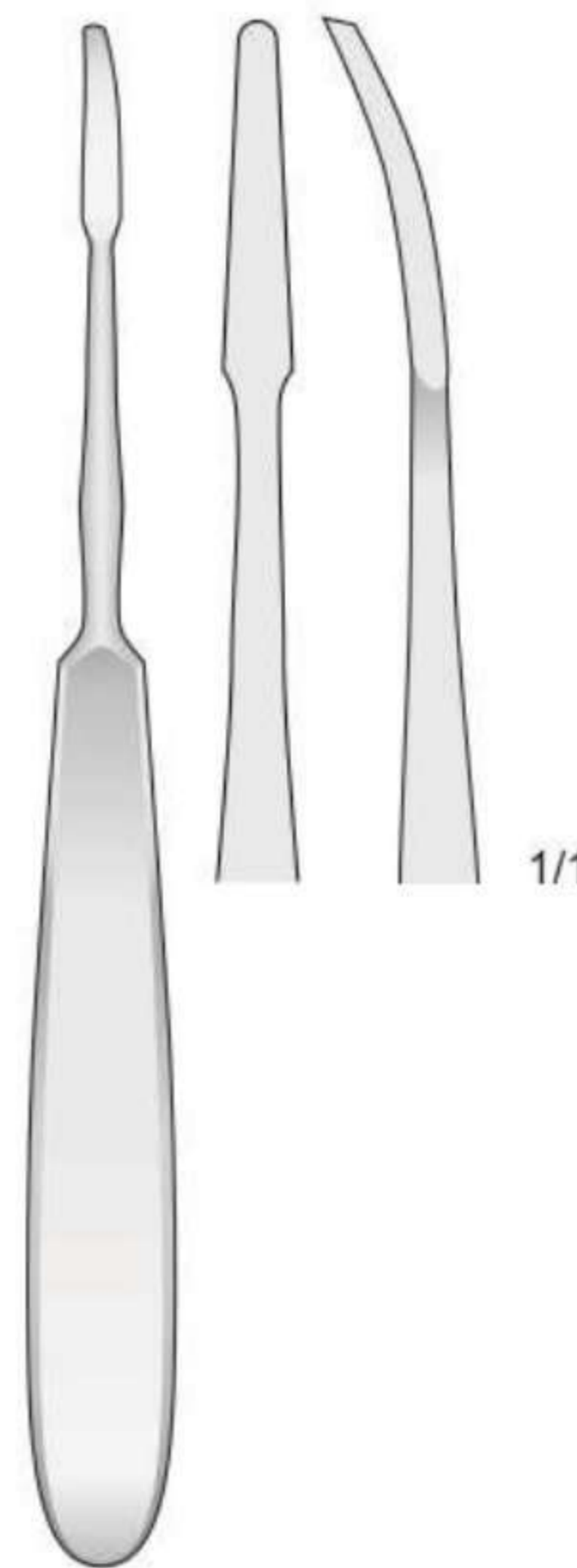

JOSEPH
FK-265
160 mm

7 mm

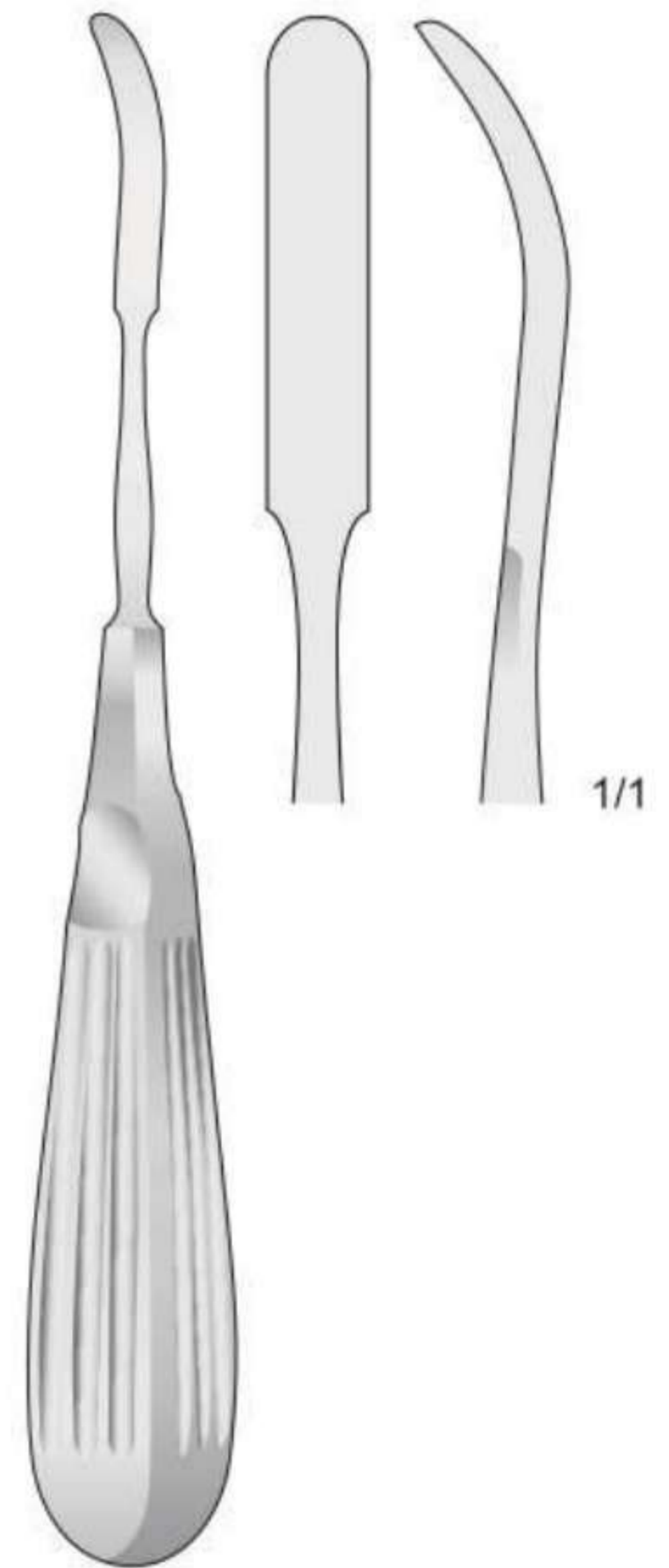

JOSEPH
FK-82
180 mm

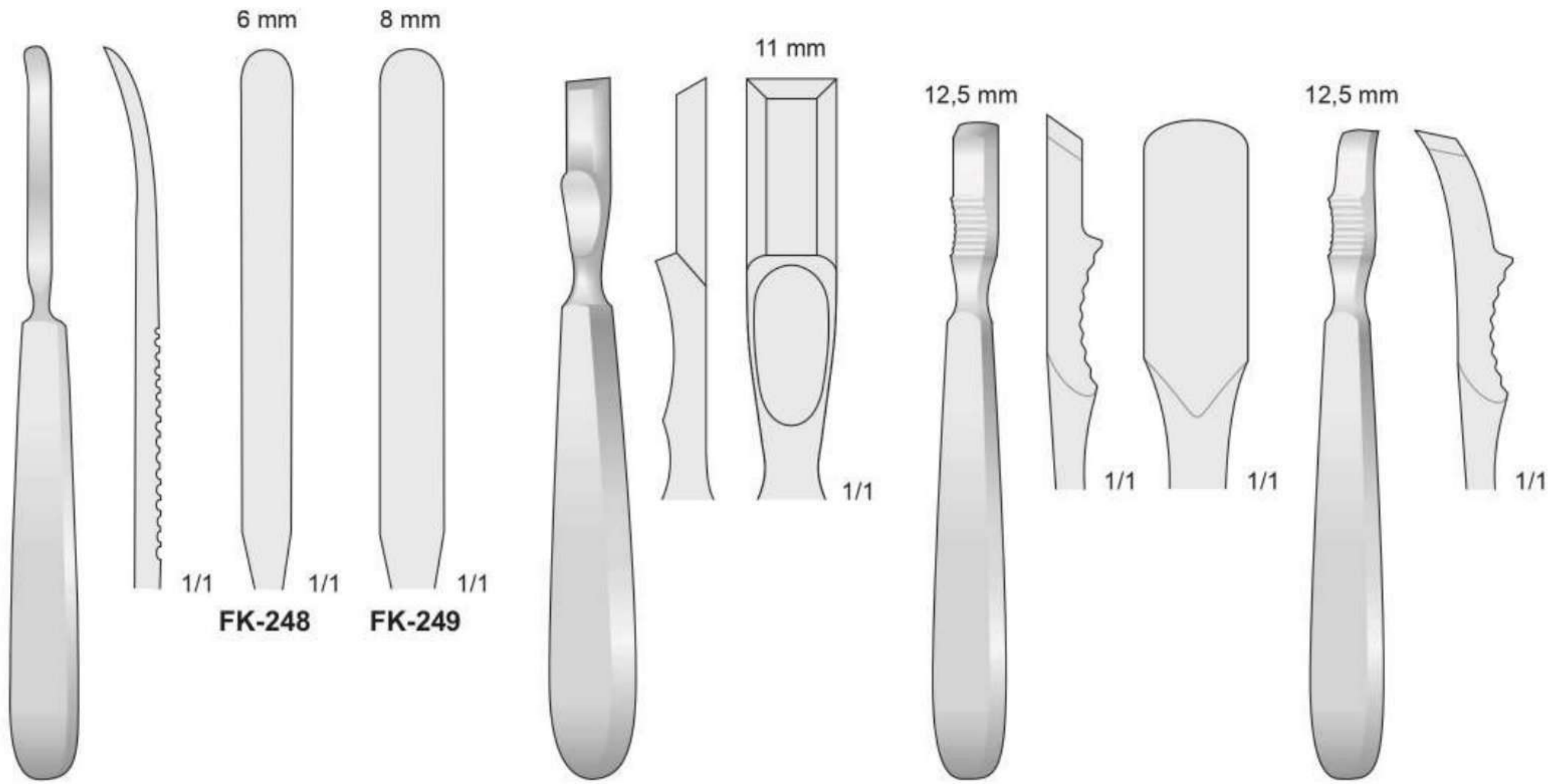

FK-248/FK-249
170 mm

FARABEU-FOLLIN
FK-247
160 mm

FARABEU
FK-250
150 mm

FARABEU
FK-251
150 mm

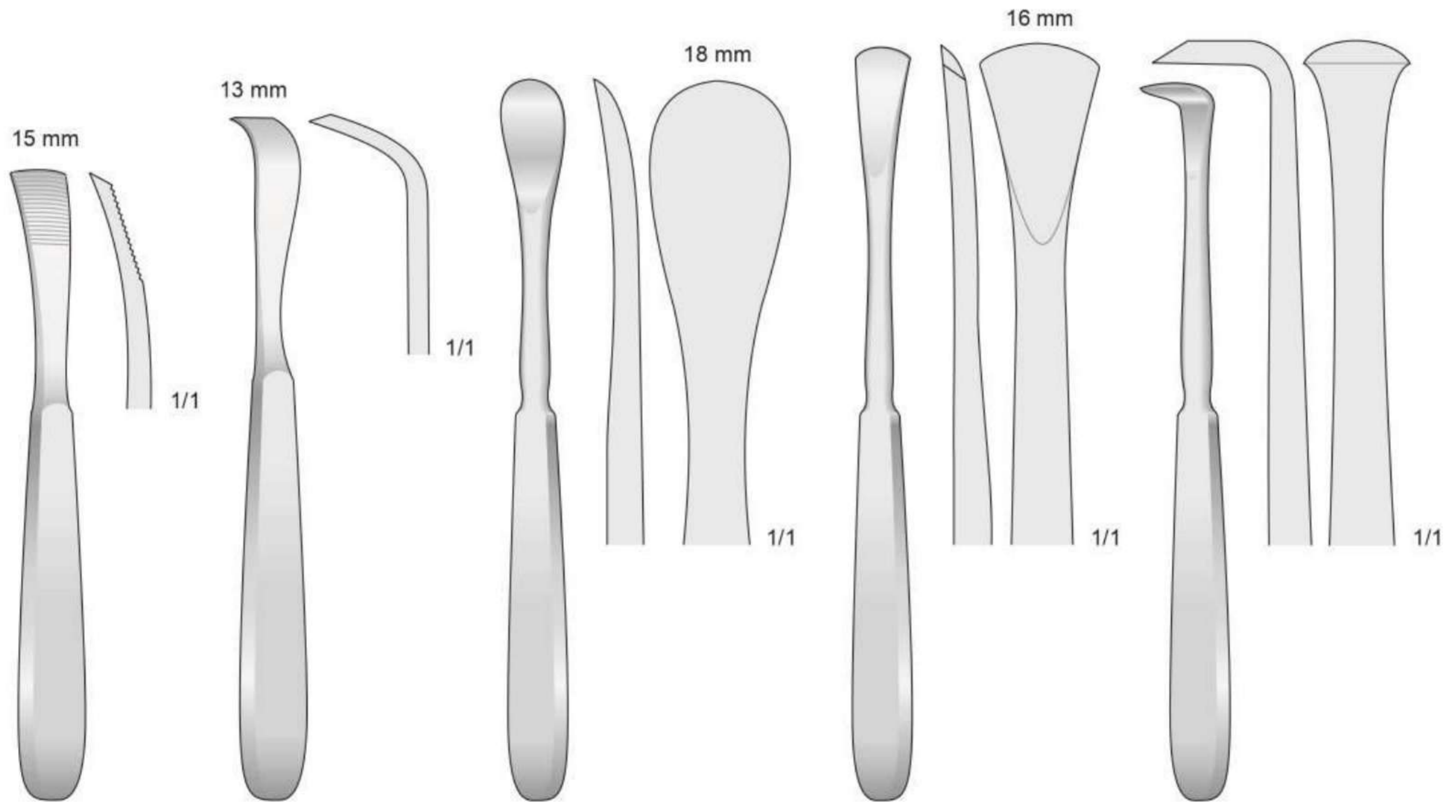

JANSEN
FK-255
165 mm

SCHNEIDER
FK-258
175 mm

SEDILLOT
FK-254
185 mm

LANGENBECK
FK-256
190 mm

LANGENBECK
FK-257
180 mm

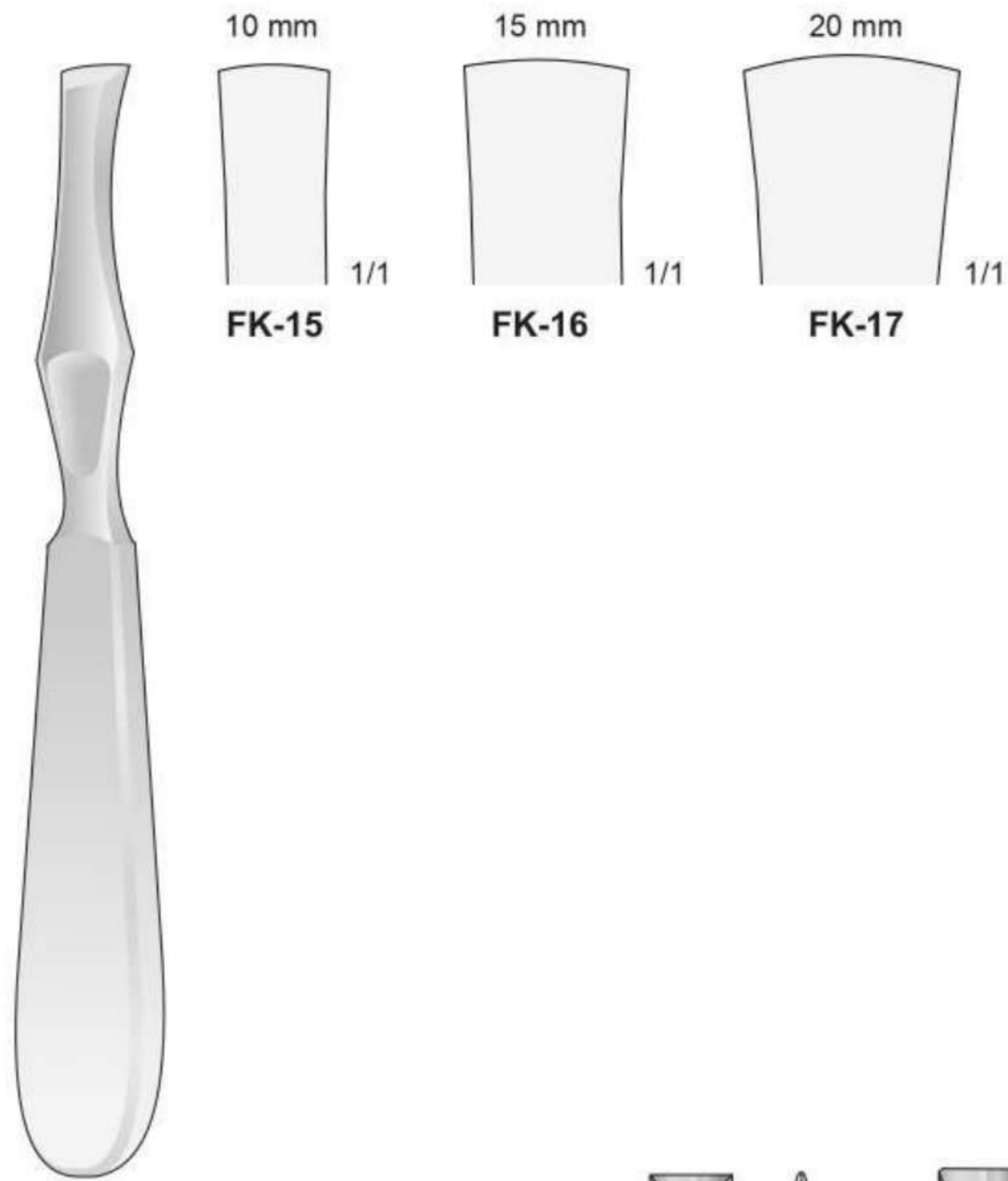

LAMBOTTE
FK-15/FK-17
205 mm

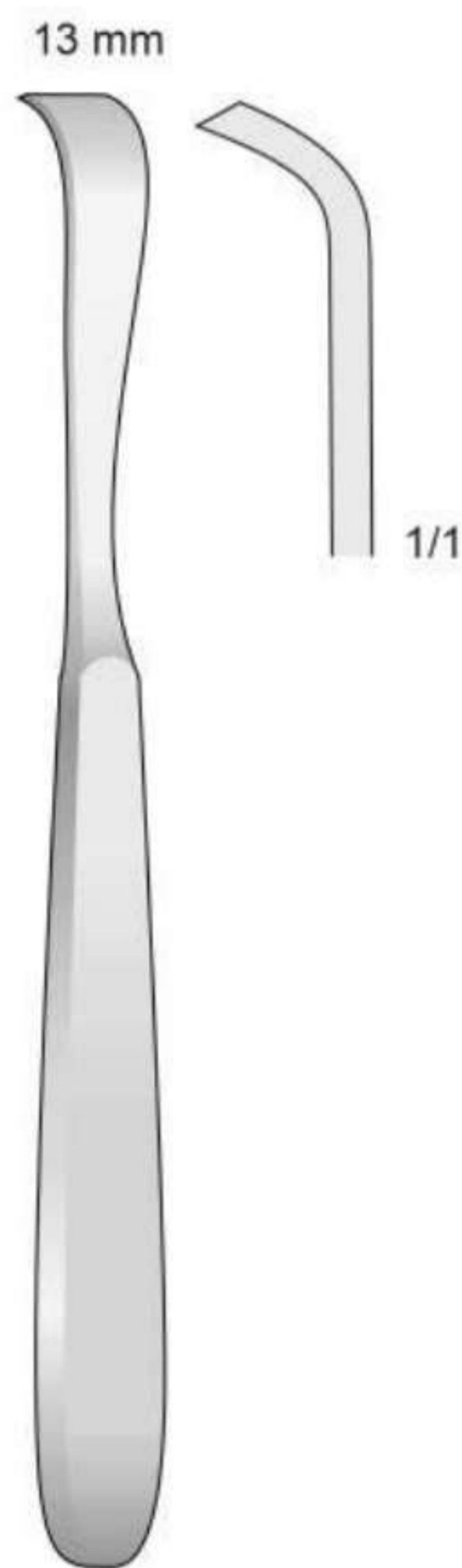

SCHNEIDER-SAUERBRUCH
FK-259
190 mm

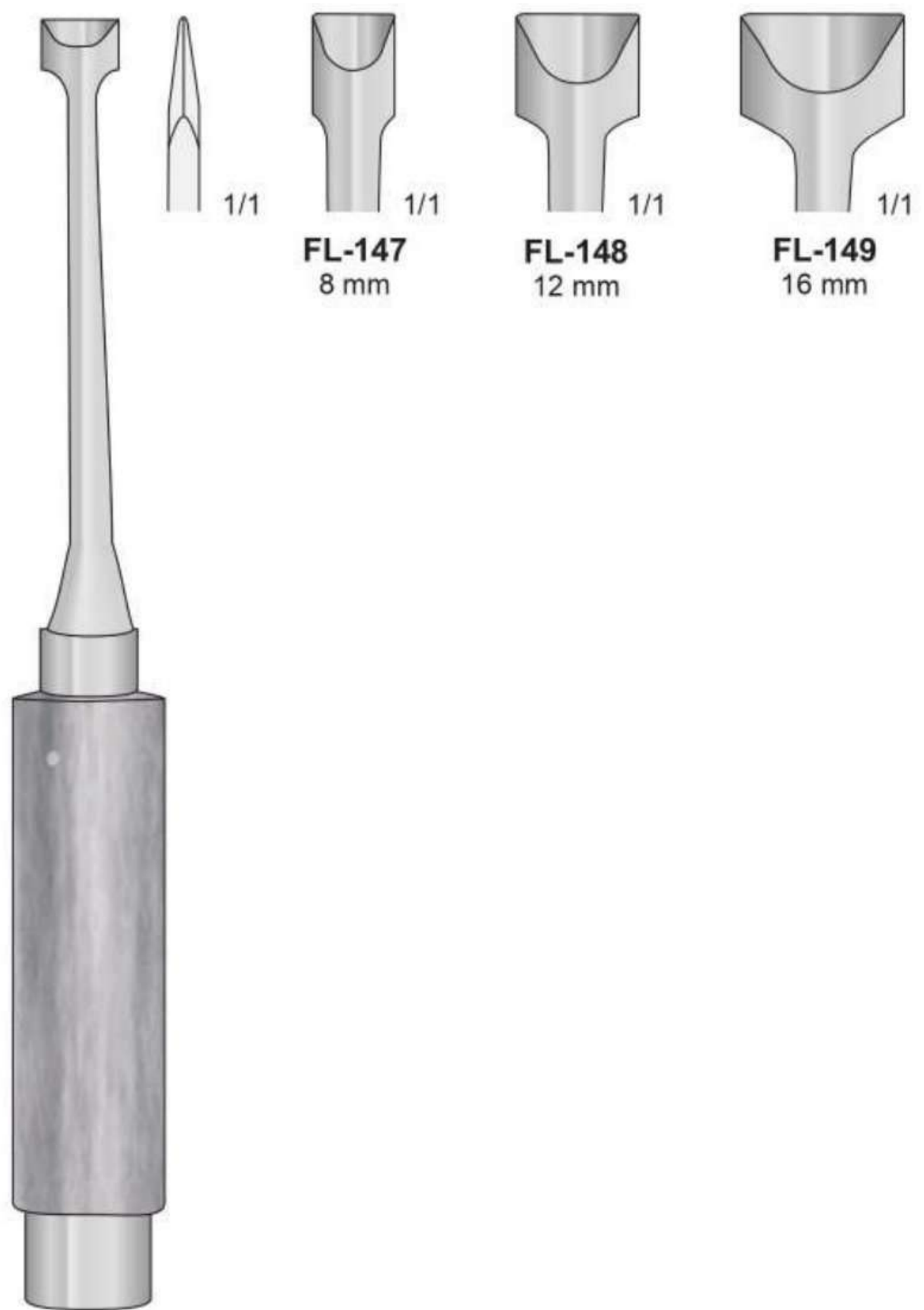

OBWEGESER
FL-147/FL-149
220 mm

Raspatorien

Periosteal Raspatories

Scollaperiosteo (Periostotomi)

Periostótomos (Legras)

Rugines périostiques

Mit Ferrozellgriff
With Ferrozell handle
Con manico Ferrozell
Con mango de Ferrozell
Avec poignée en Ferrozell

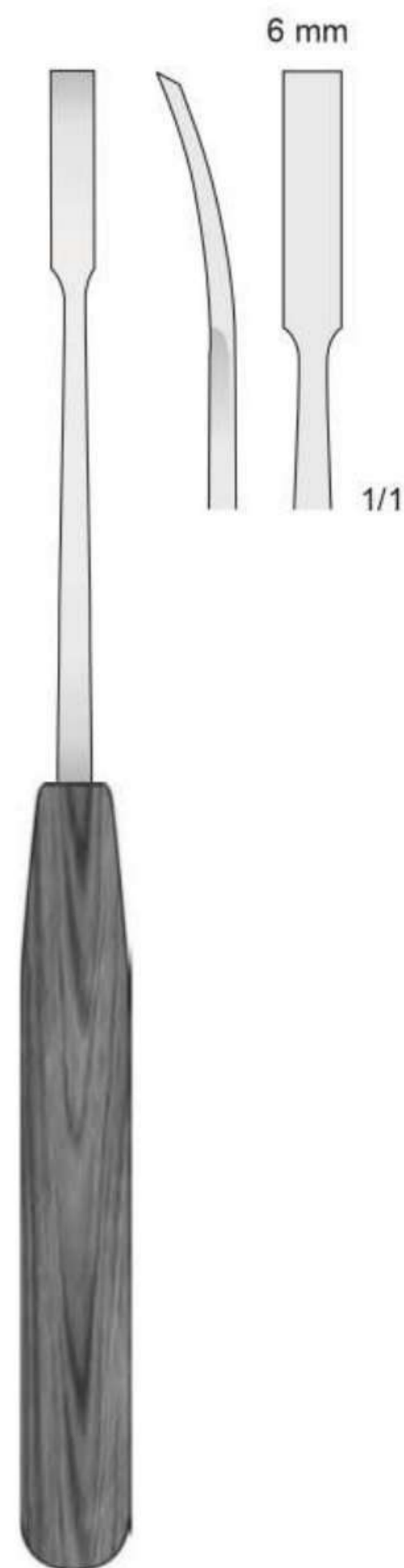
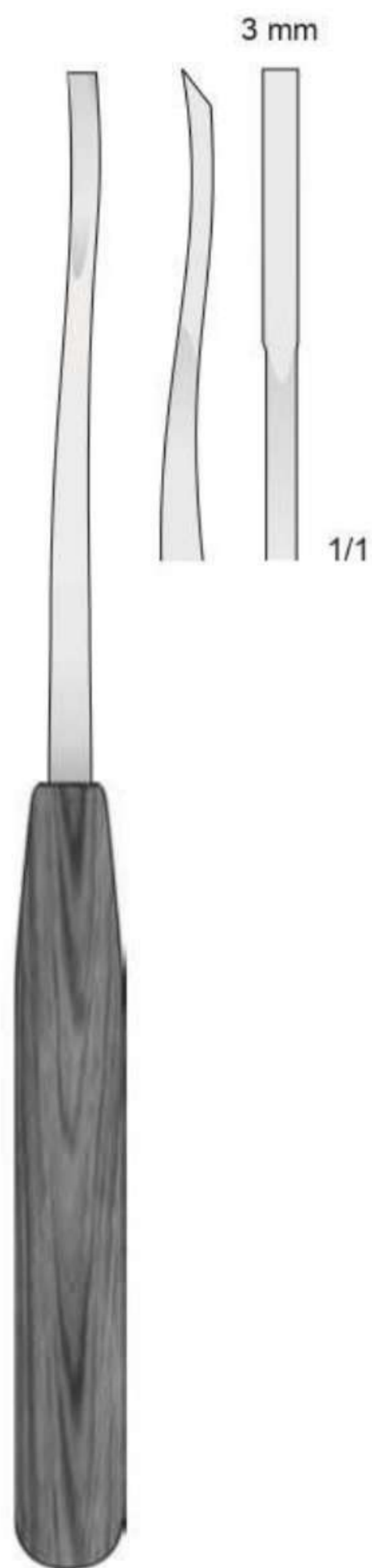

Mit Ferrozellgriff
With Ferrozell handle
Con manico Ferrozell
Con mango de Ferrozell
Avec poignée en Ferrozell

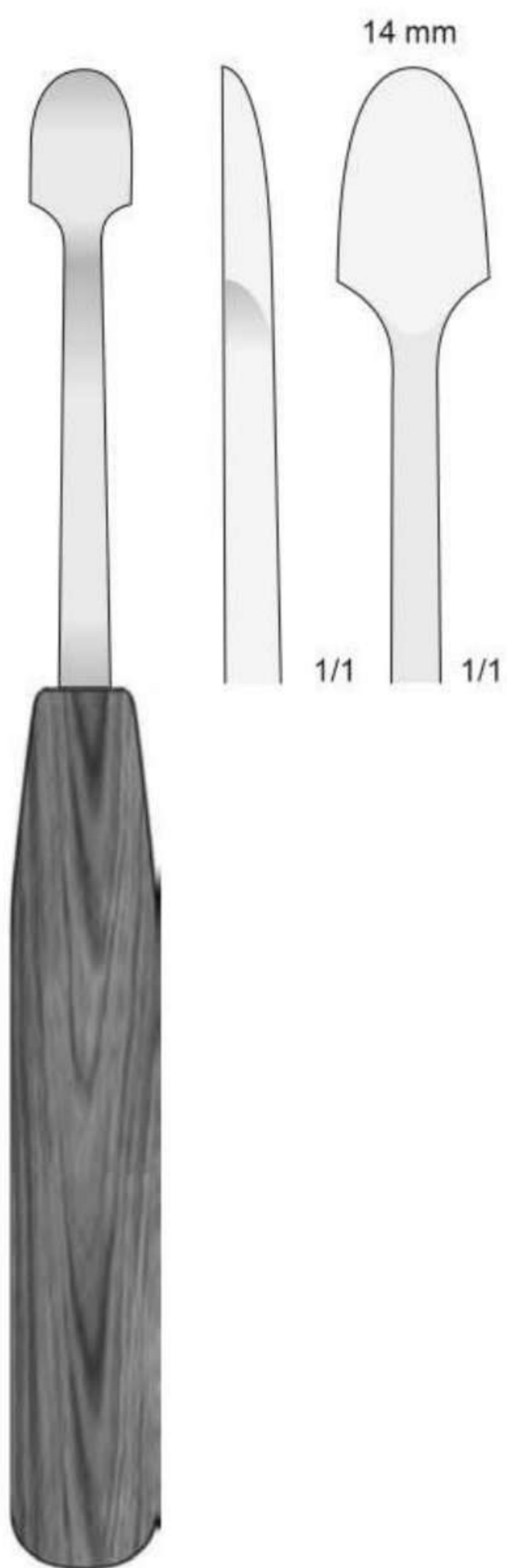

FK-236
200 mm

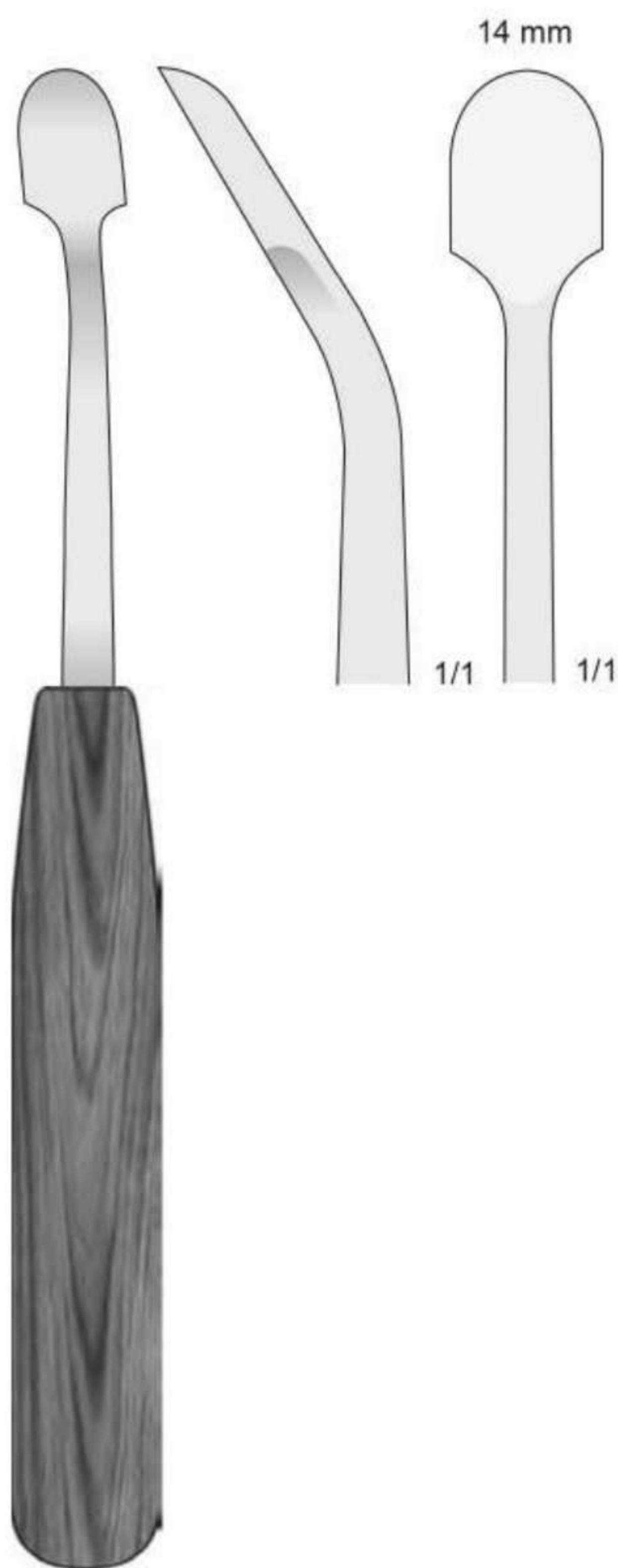

FK-238
200 mm

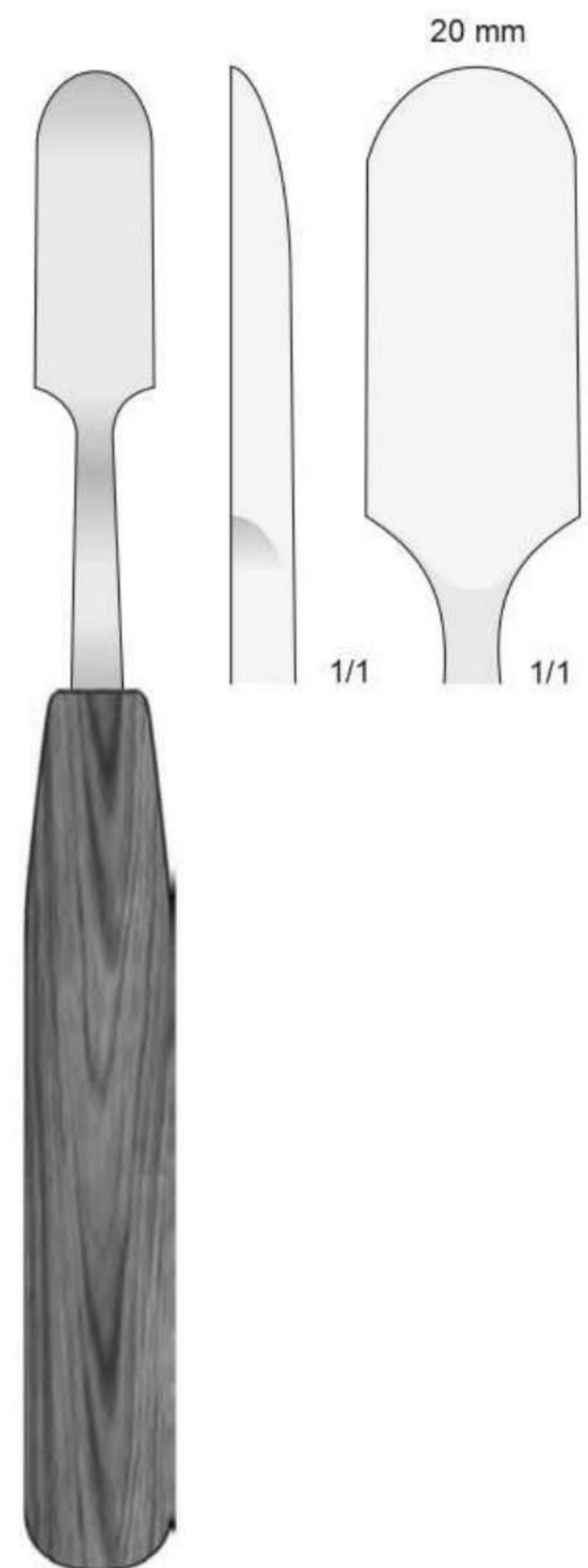

FK-240
200 mm

Raspatorien

Periosteal Raspatories

Scollaperiosteo (Periostotomi)

Periostótomos (Legras)

Rugines périostiques

Mit Ferrozellgriff
With Ferrozell handle
Con manico Ferrozell
Con mango de Ferrozell
Avec poignée en Ferrozell

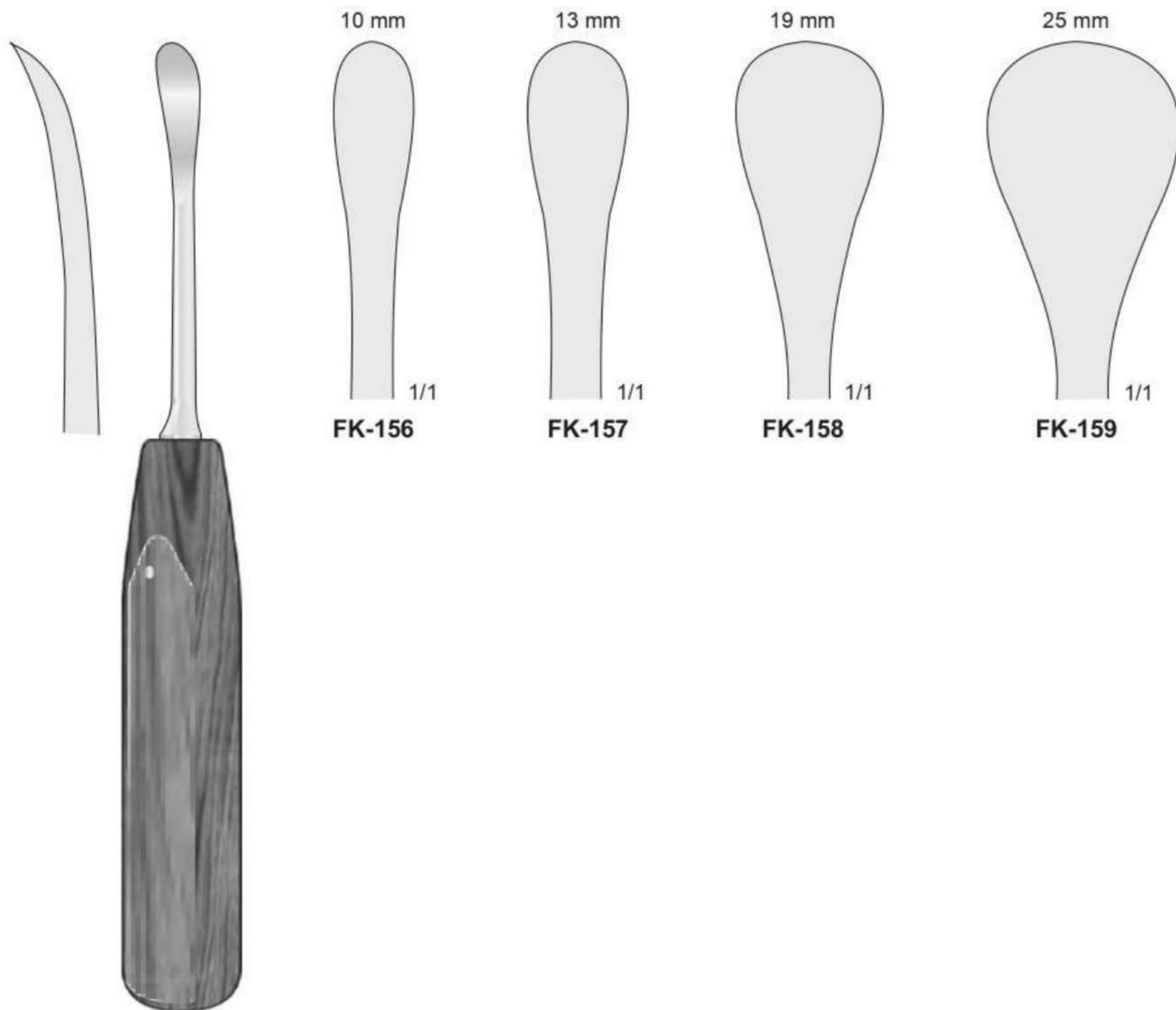

COBB
FK-156/FK-159
250 mm

Knochenfeilen

Bone files

Lime per osso

Limas para huesos

Limes à os

Fig. 67

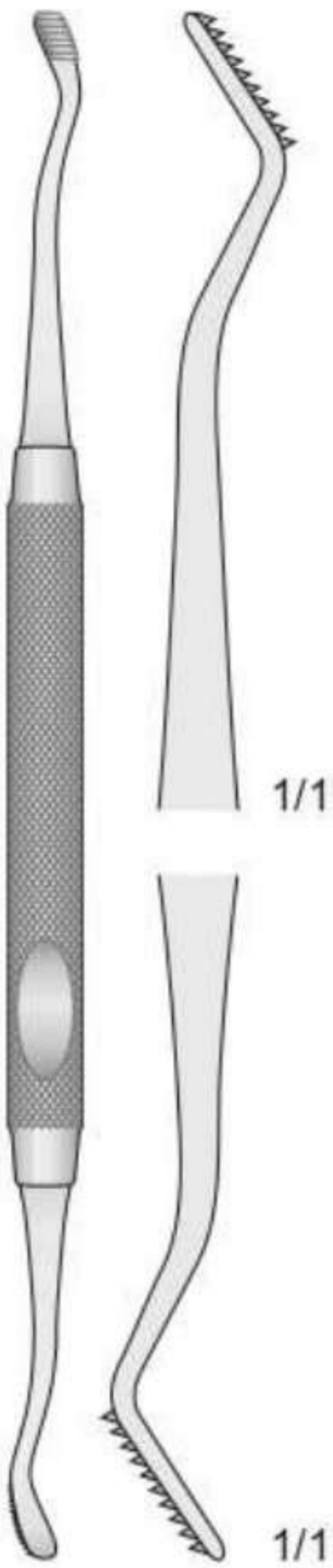

HOWARD
DO-1
180 mm

Fig. 45

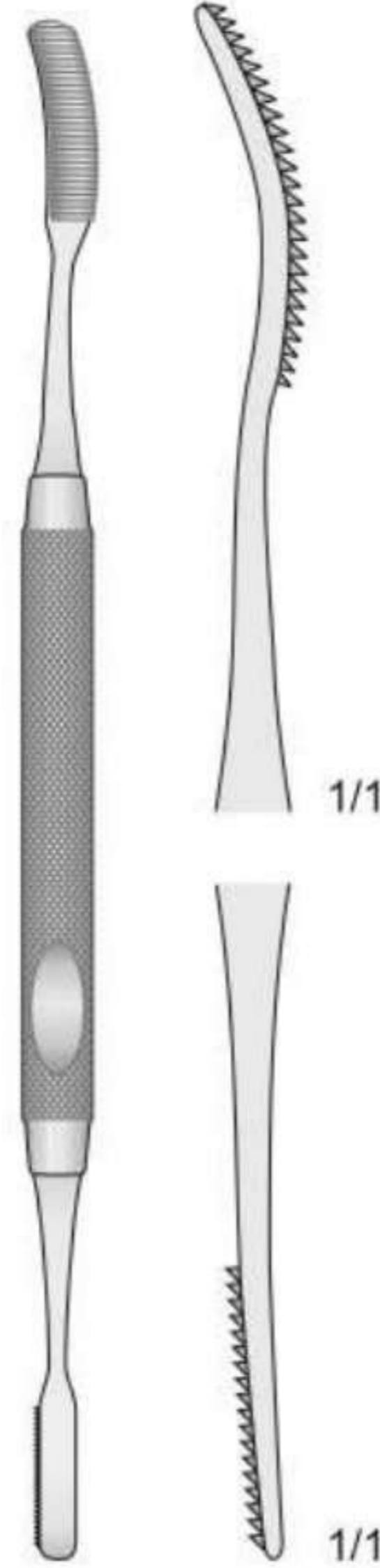

MILLER
DO-2
185 mm

Fig. 52

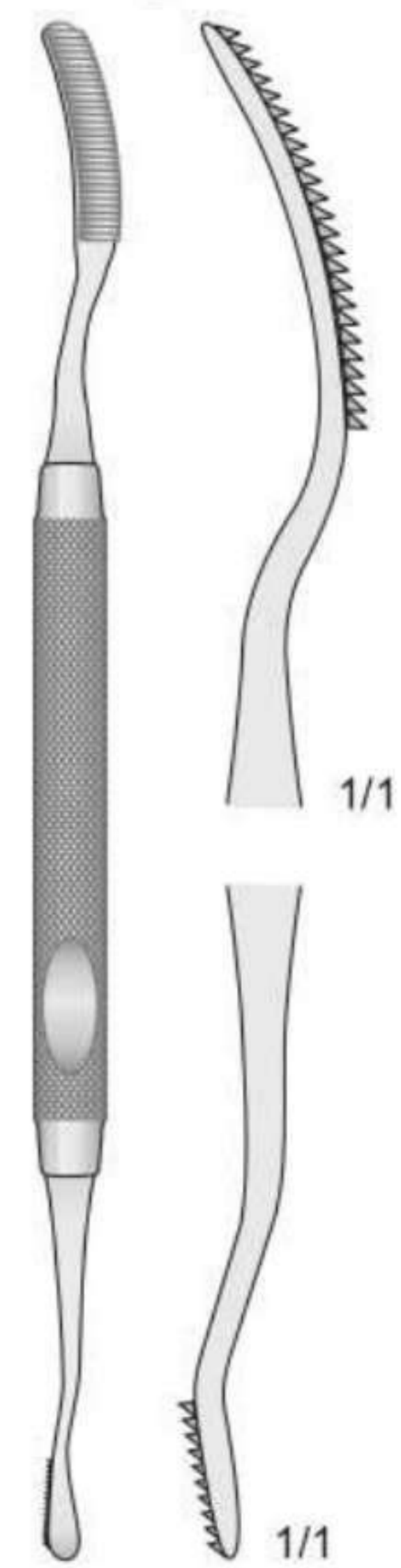

MILLER
DO-3
180 mm

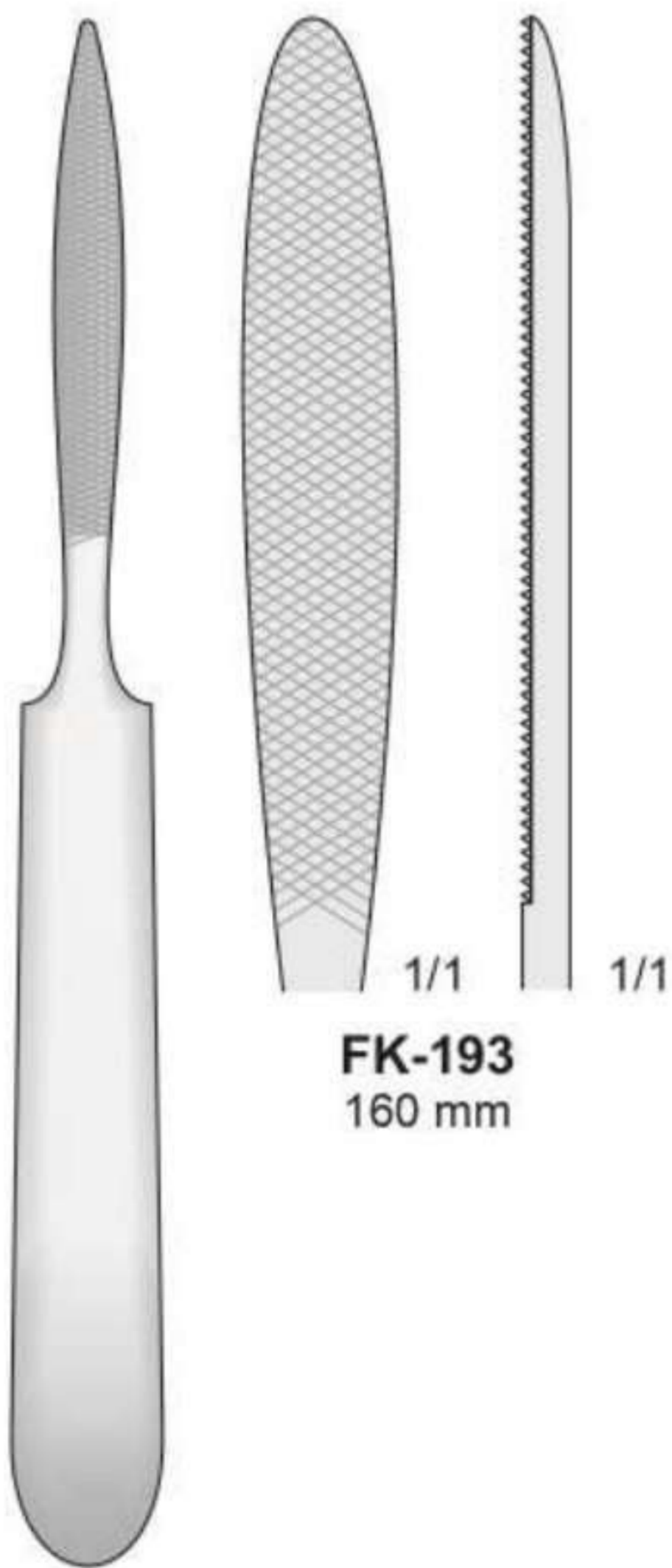

JOSEPH
FK-193
160 mm

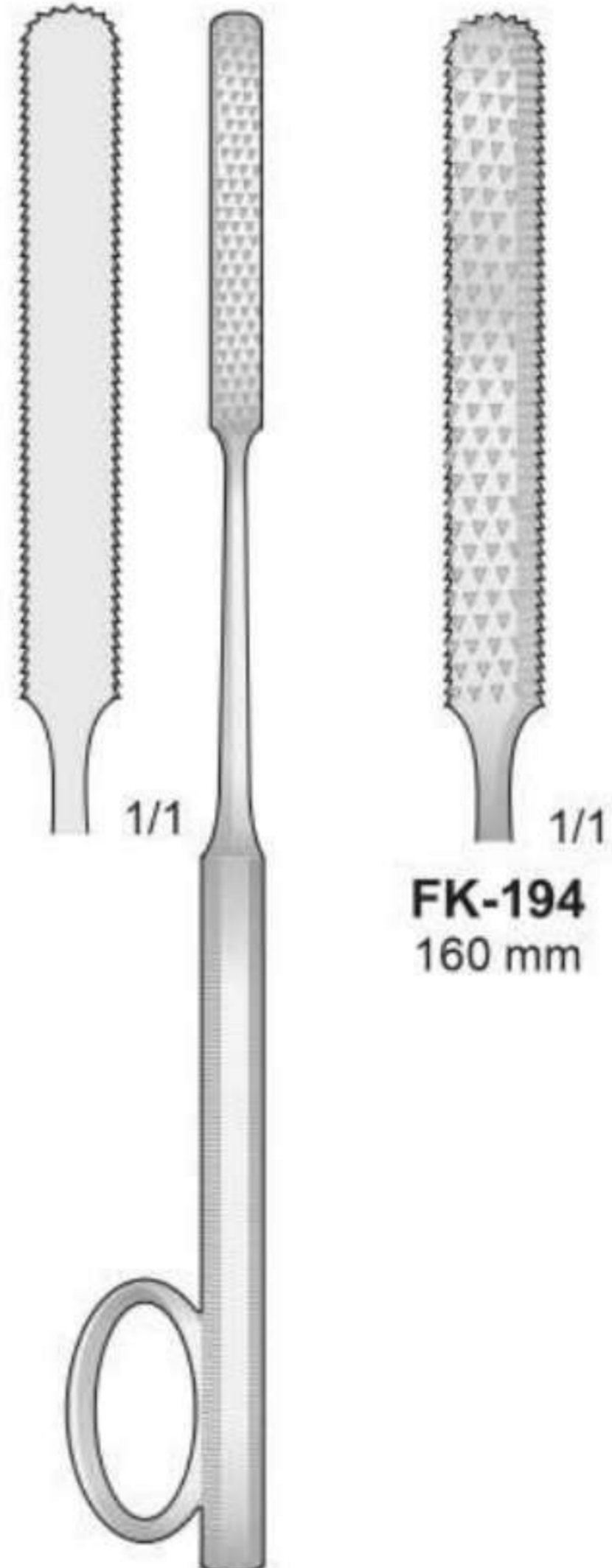

GALLAHER
FK-194/FK-196
160 mm

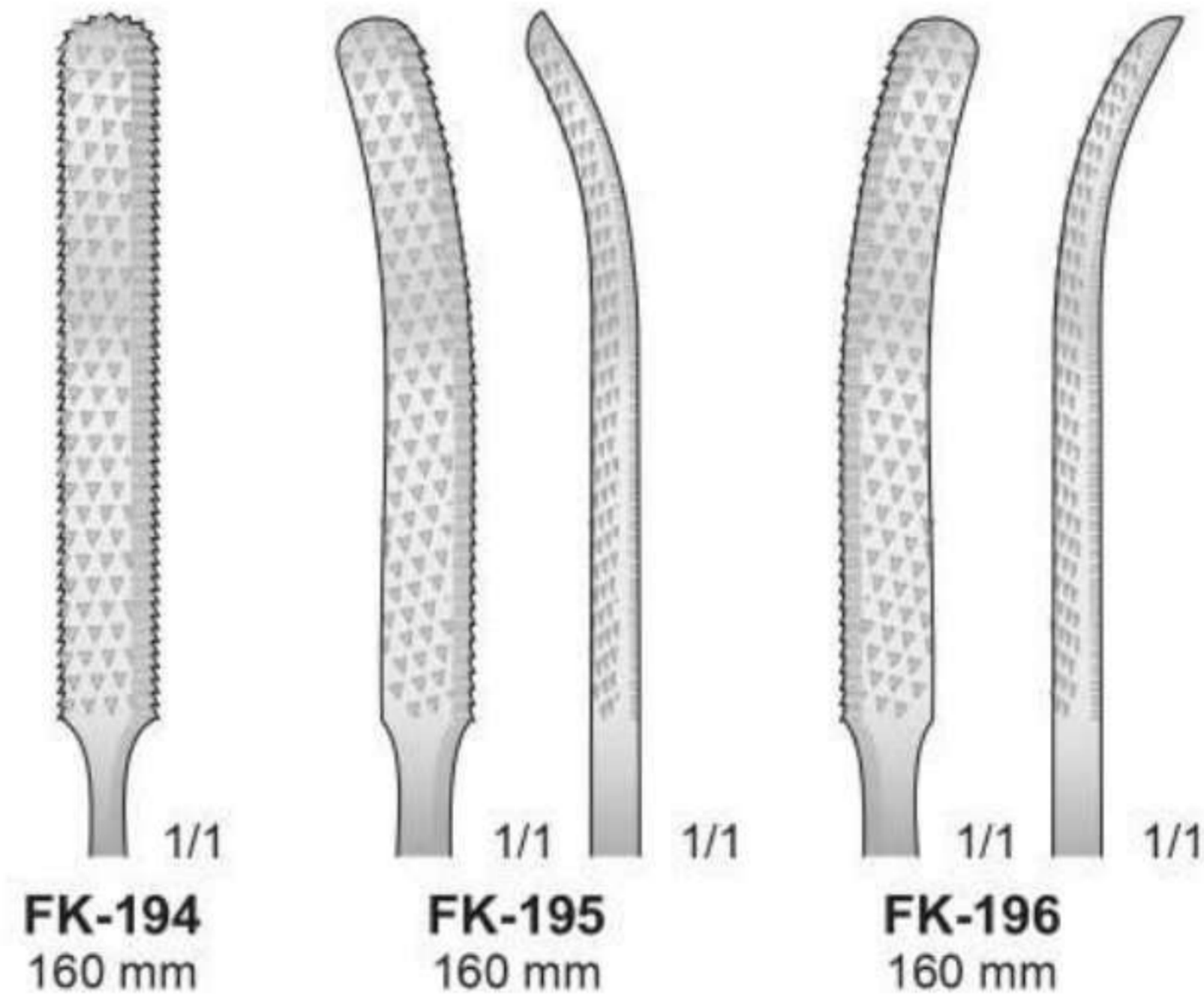

FK-194
160 mm

FK-195
160 mm

FK-196
160 mm

Knochenfeilen

Bone files

Lime per osso

Limas para huesos

Limes à os

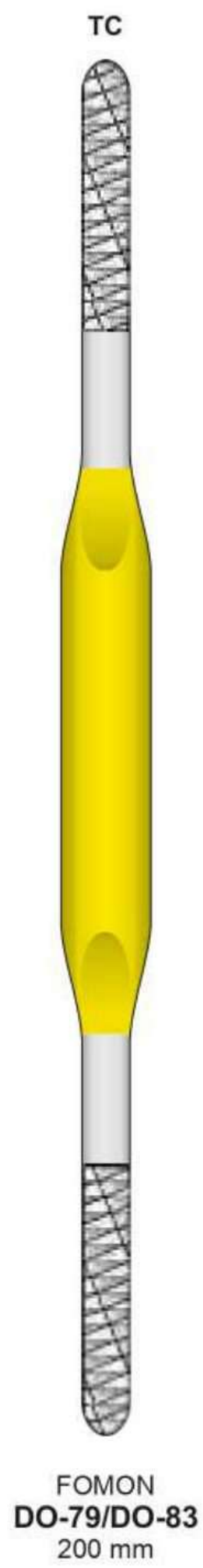

1



3



5



7



9



2



4



6



8



10

DO-79

DO-80

DO-81

DO-82

DO-83

Knochenfeilen

Bone files

Lime per osso

Limas para huesos

Limes à os

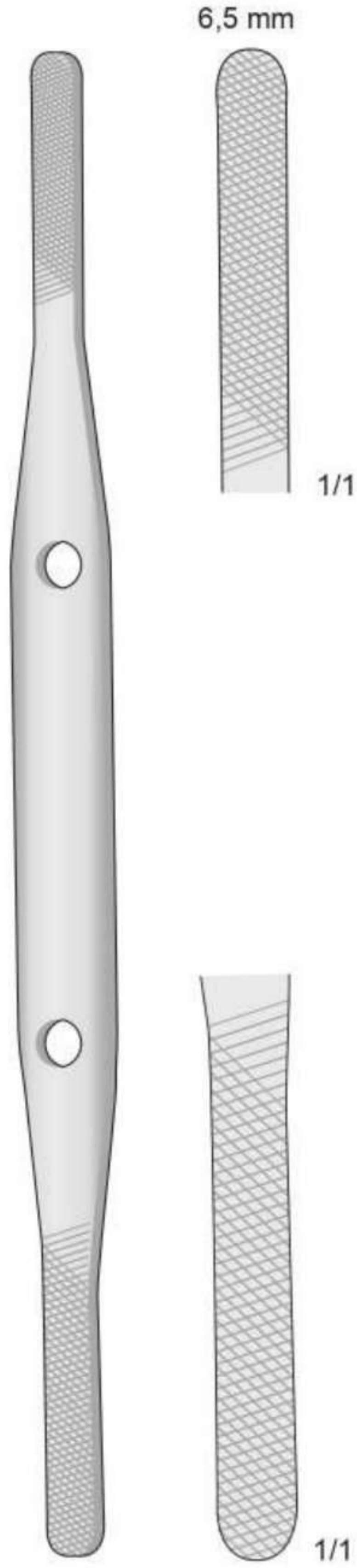

FOMON
DO-168
210 mm



7,5 mm

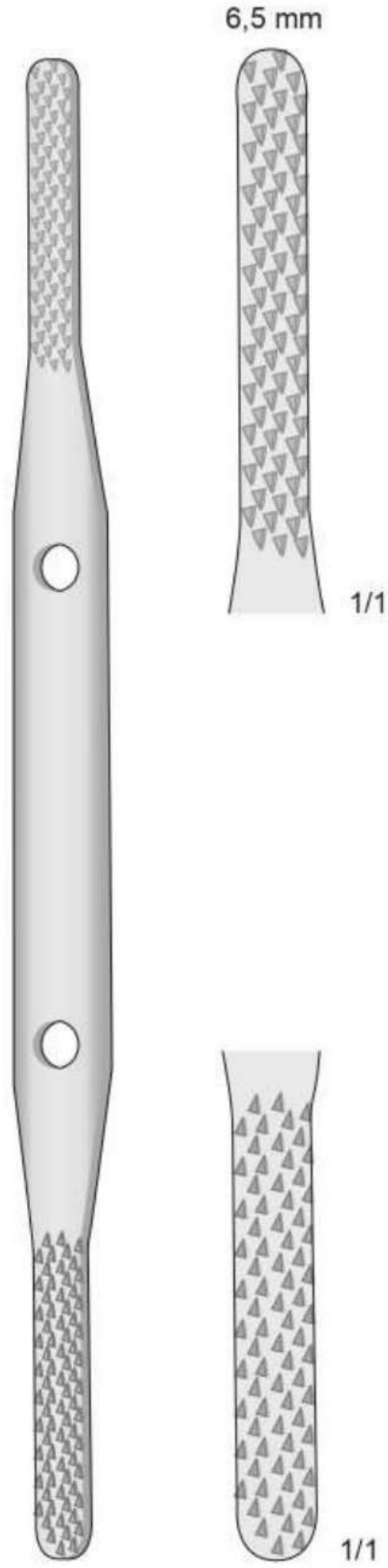

FOMON
DO-169
210 mm



7,5 mm

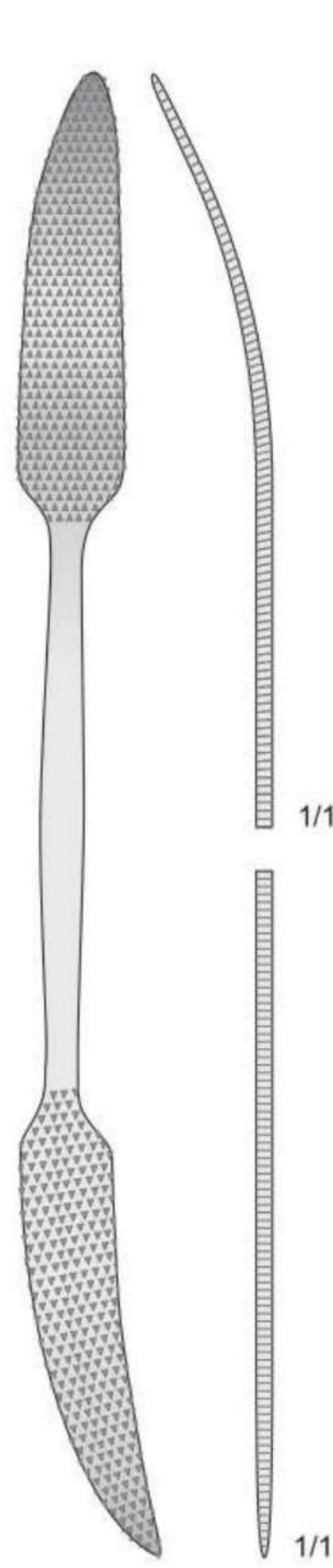

PUTTI
FK-94
270 mm

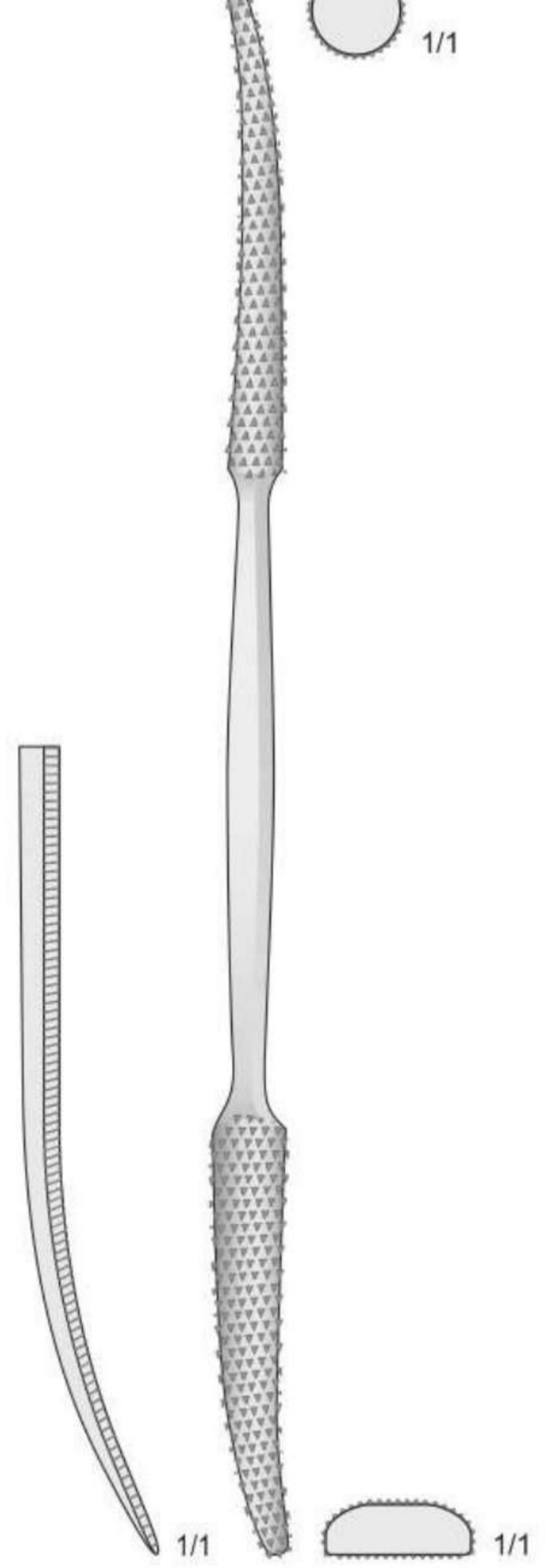

PUTTI
FK-95
300 mm

Knochenfeilen

Bone files

Lime per osso

Limas para huesos

Limes à os

20 mm



FK-85
295 mm

13 mm



FK-86
240 mm

20 mm

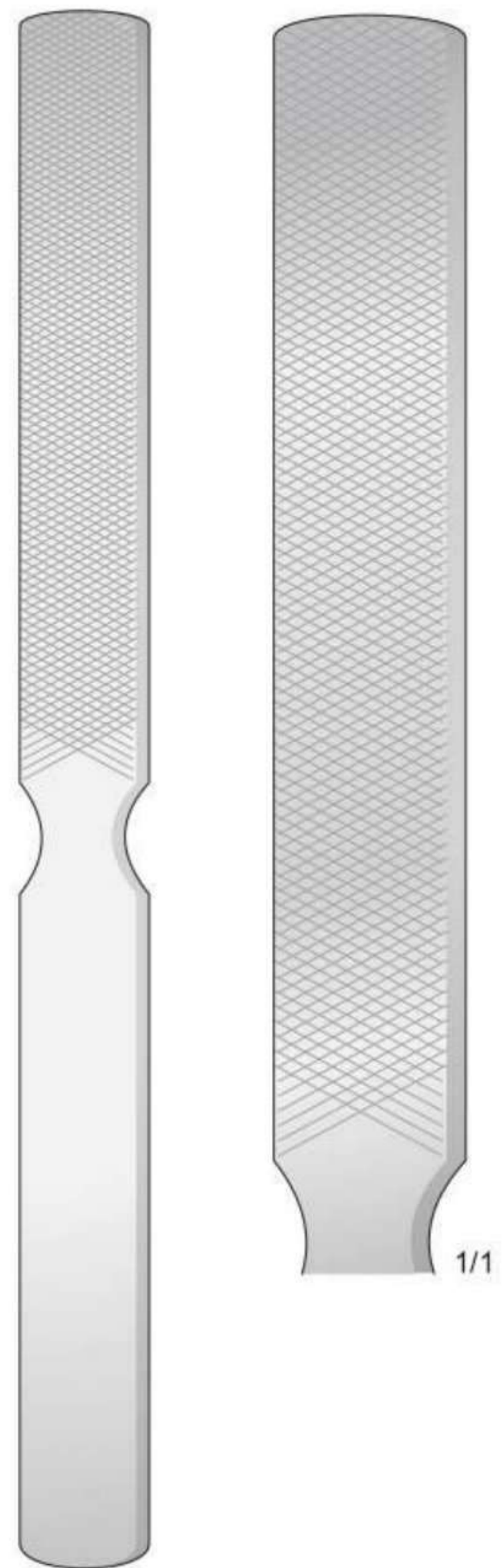

FK-119
220 mm

Scharfe Küretten

Sharp curettes

Curette taglienti

Cucharillas cortantes

Curettes tranchantes

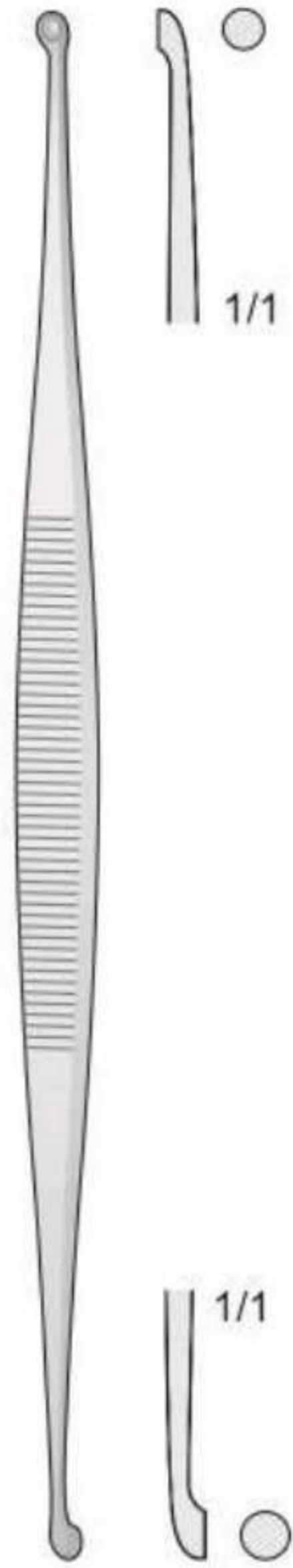

MARTINI
FK-70
140 mm

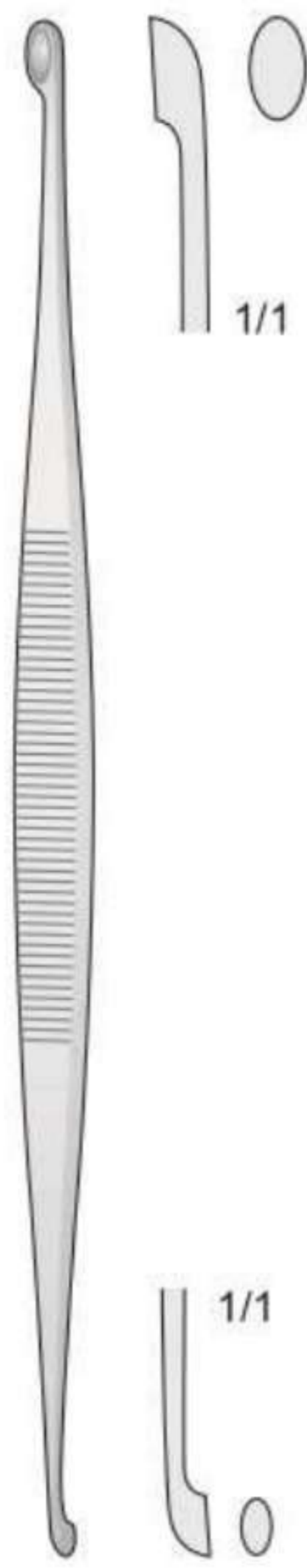

WILLIGER
FK-71
145 mm

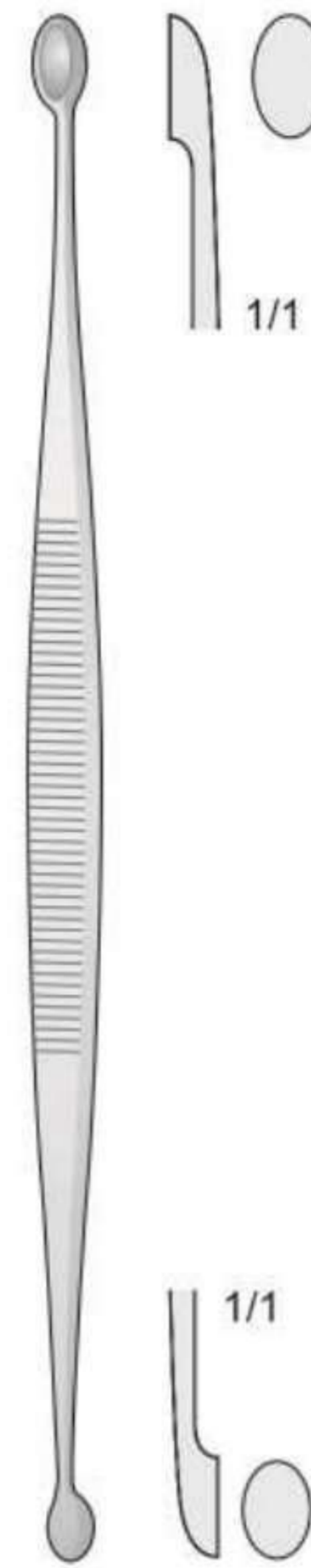

JACOBSON
FK-75
140 mm

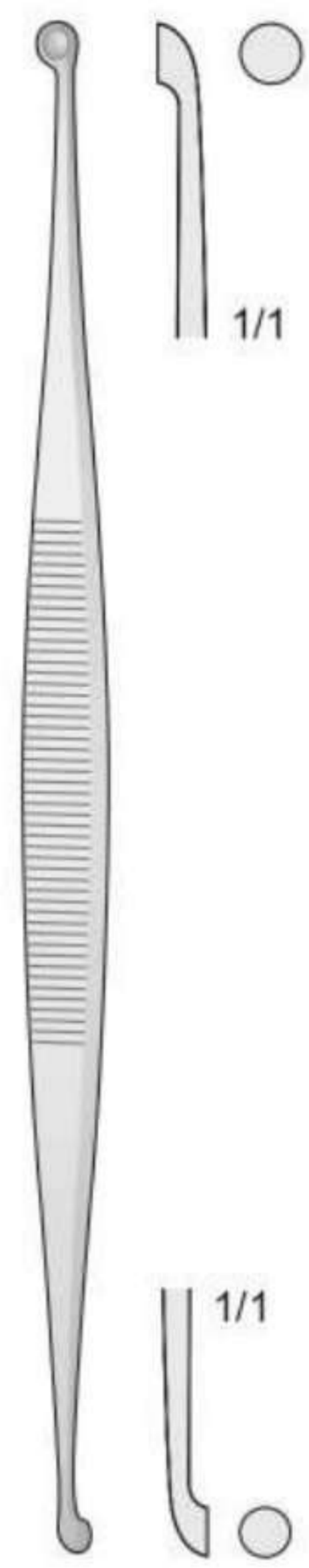

MARTINI
FK-76
140 mm

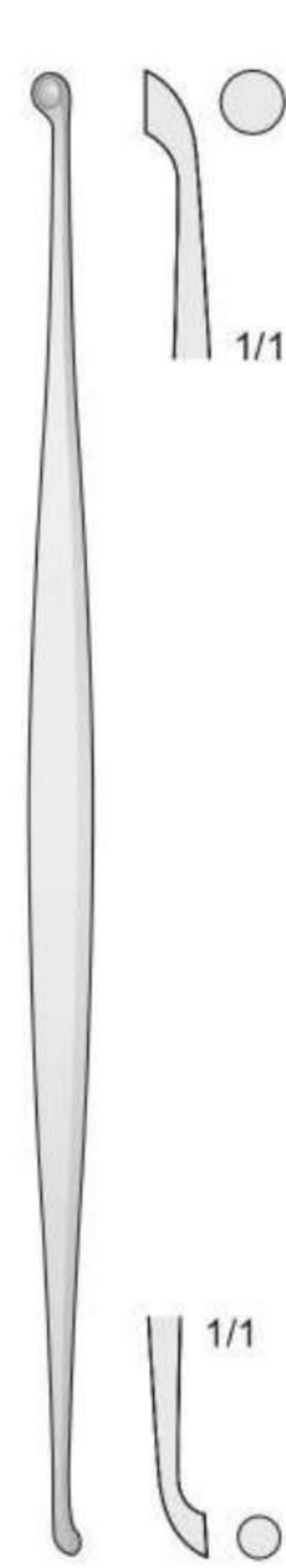

JANSEN
FK-77
160 mm

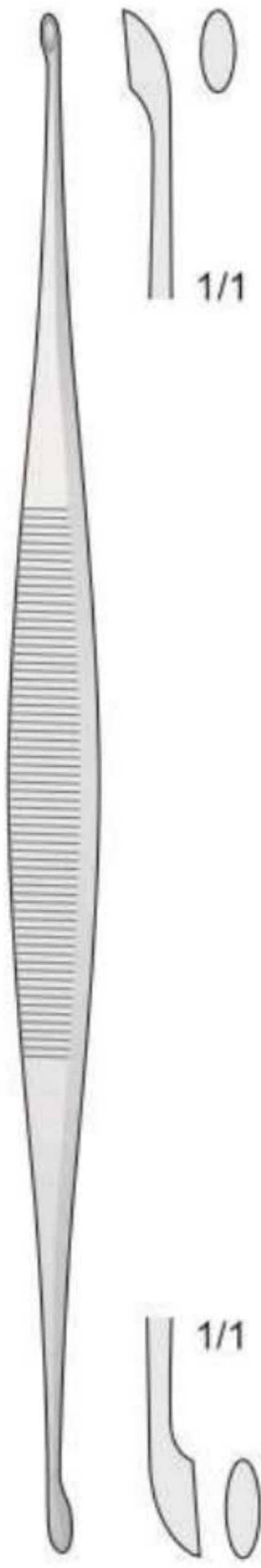

BARTH
FK-78
180 mm

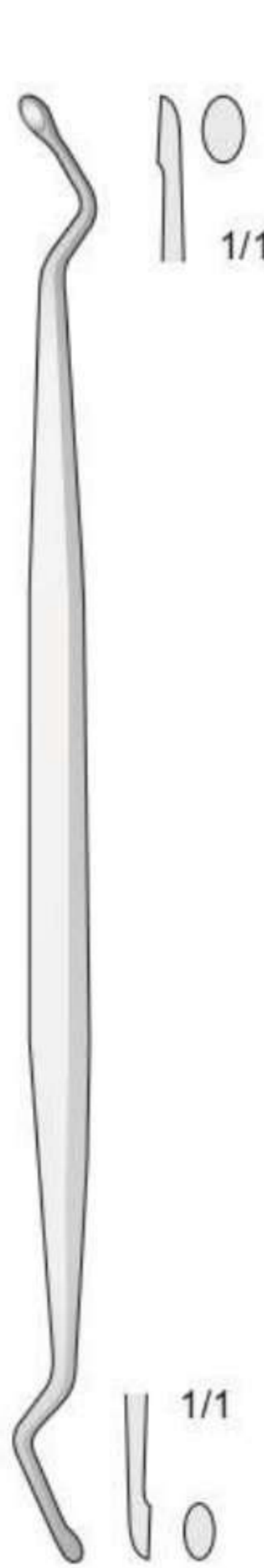

FK-83
160 mm

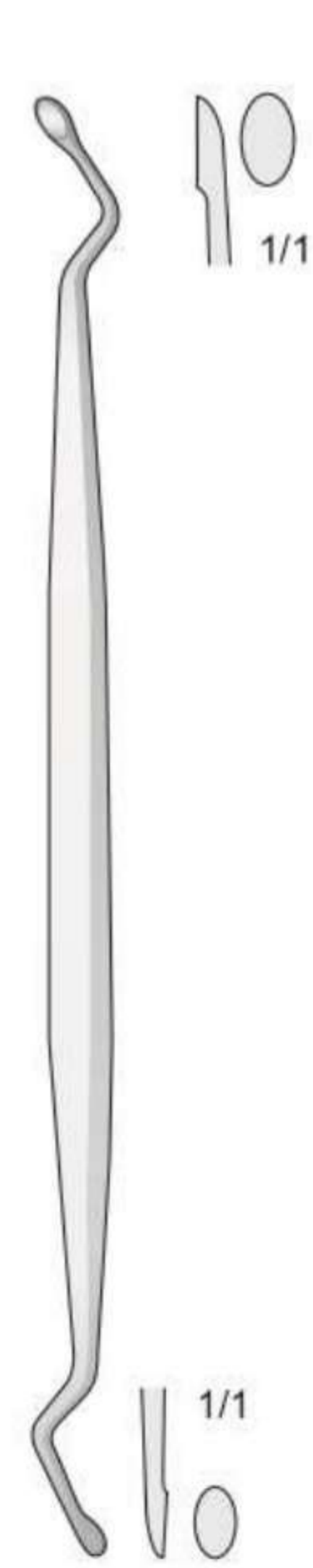

JANSEN
FK-84
160 mm

Scharfe Küretten

Sharp curettes

Curette taglienti

Cucharillas cortantes

Curettes tranchantes

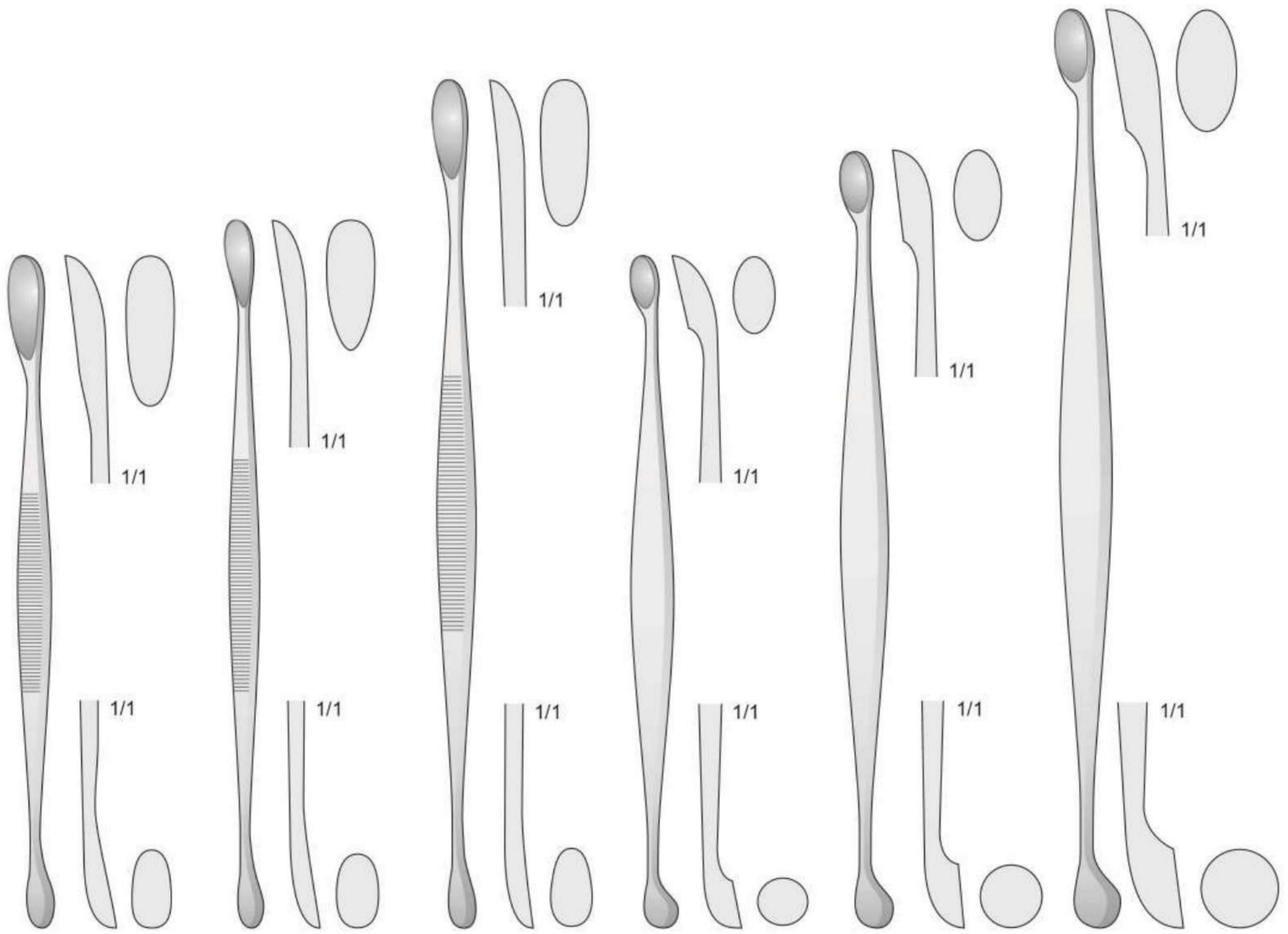

VOLKMANN
FK-79
130 mm

VOLKMANN
FK-72
145 mm

VOLKMANN
FK-73
170 mm

FK-177
130 mm

FK-74
160 mm

FK-178
200 mm

Scharfe Küretten

Sharp curettes

Curette taglienti

Cucharillas cortantes

Curettes tranchantes

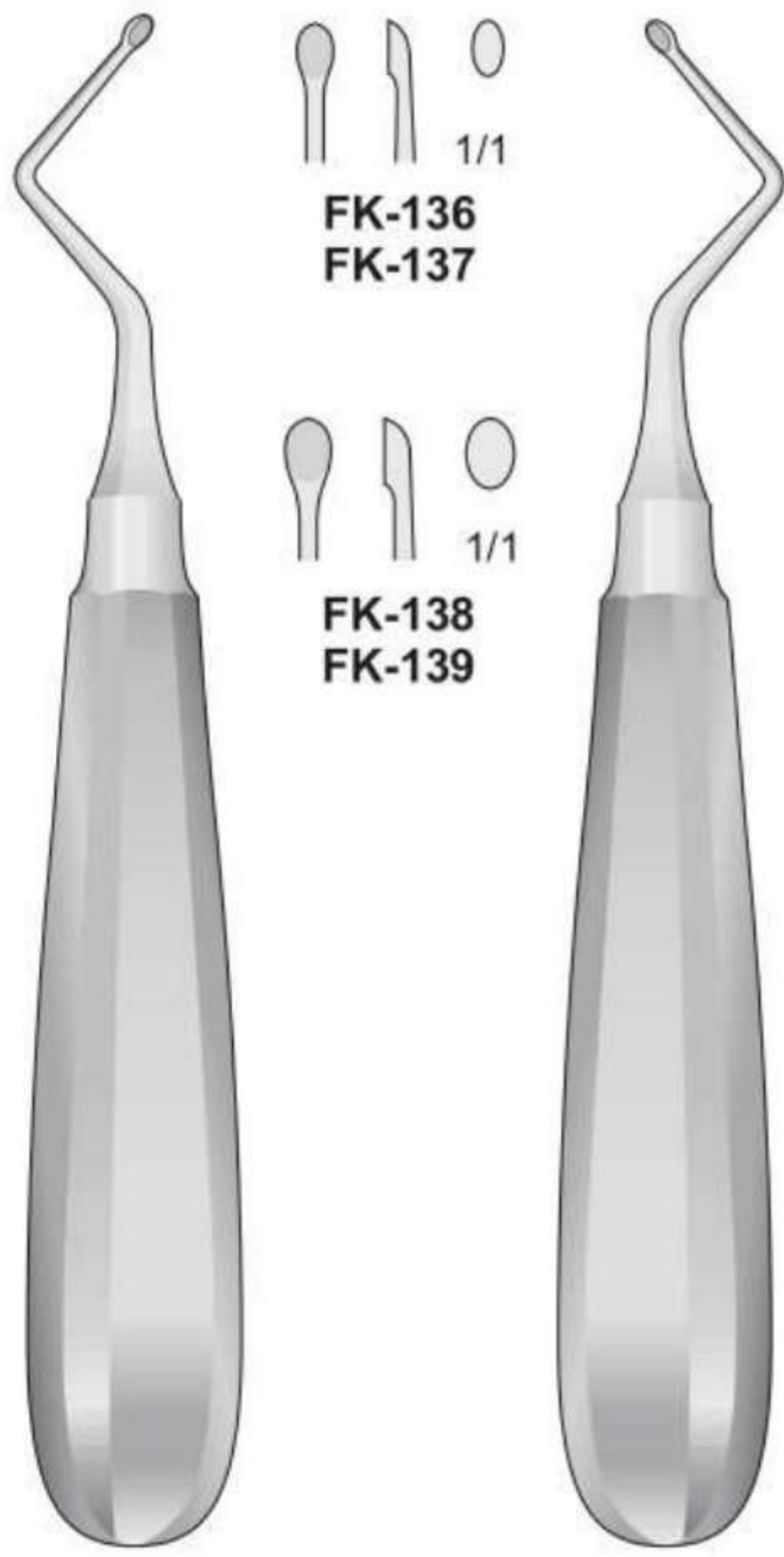

KERPEL
FK-136
FK-138
145 mm

KERPEL
FK-137
FK-139
145 mm

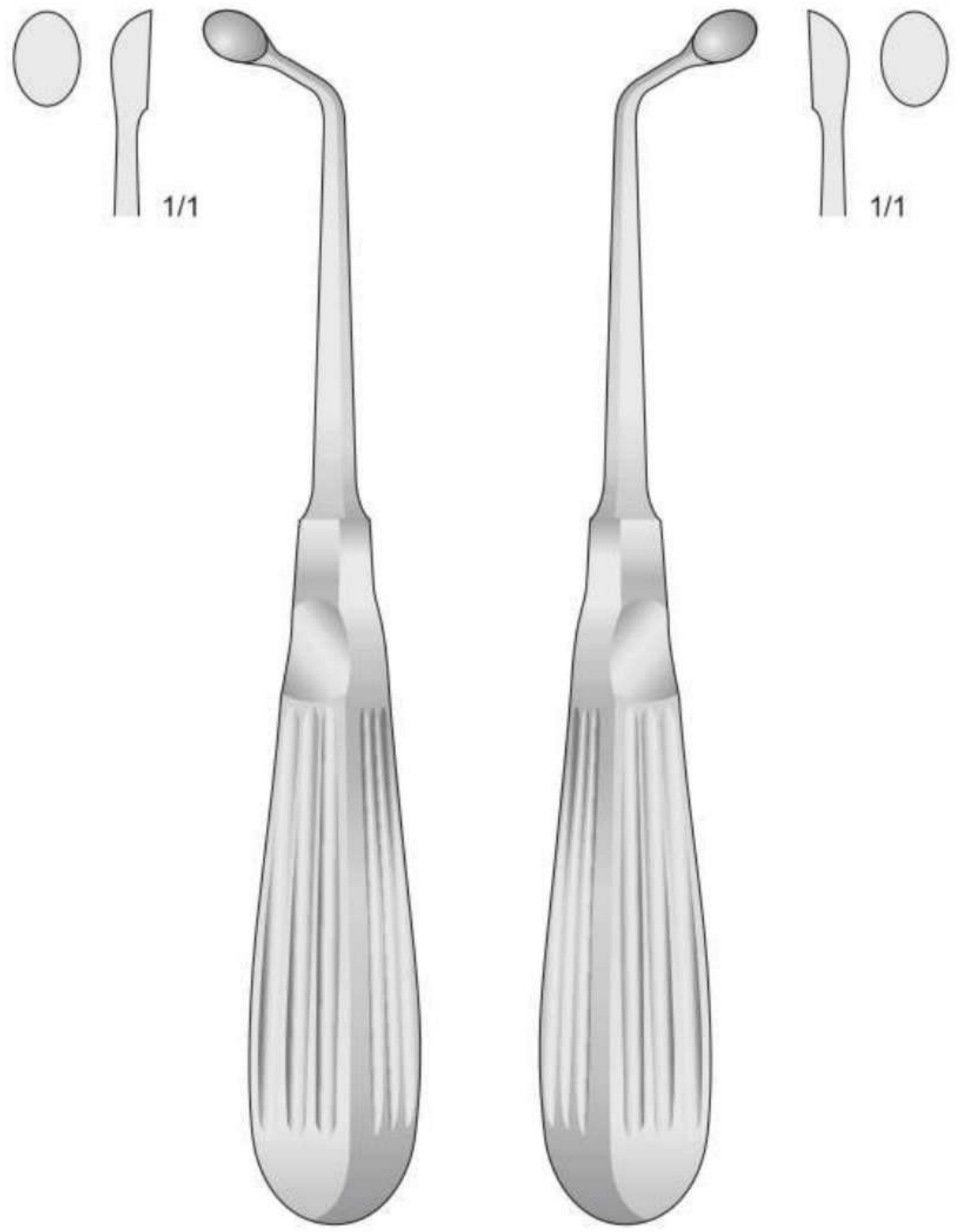







UFFENDORDE
FK-188
170 mm

UFFENDORDE
FK-189
170 mm



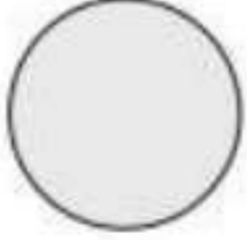



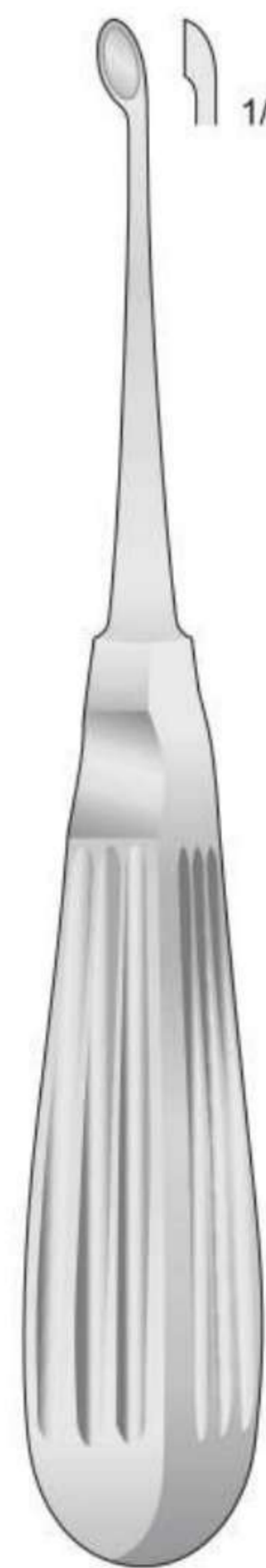

BRUNS
FK-110/FK-116
165 mm

- | | | |
|--|---|--|
| Fig.000
3 mm

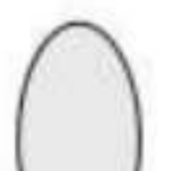
FK-110 | Fig.00
4 mm

FK-111 | Fig.0
5 mm

FK-112 |
| Fig.1
6 mm

FK-113 | Fig.2
8 mm

FK-114 | |
| Fig.3
10 mm

FK-115 | Fig.4
12 mm

FK-116 | |



SCHEDE
FK-120/FK-126
170 mm

- | | | |
|--|---|--|
| Fig.000
2,5 mm

FK-120 | Fig.00
3,4 mm

FK-121 | Fig.0
4,2 mm

FK-122 |
| Fig.1
5,2 mm

FK-123 | Fig.2
6,3 mm

FK-124 | |
| Fig.3
7,4 mm

FK-125 | Fig.4
8 mm

FK-126 | |

Scharfe Küretten

Sharp curettes

Curette taglienti

Cucharillas cortantes

Curettes tranchantes



FK-01/FK-08
180 mm

Fig.1
○ 1/1
FK-01

Fig.2
○ 1/1
FK-02

Fig.3
○ 1/1
FK-03

Fig.4
○ 1/1
FK-04

Fig.5
○ 1/1
FK-05

Fig.6
○ 1/1
FK-06

Fig.7
○ 1/1
FK-07

Fig.8
○ 1/1
FK-08



VOLKMANN
FK-60/FK-69
170 mm

Fig.0000
2,8 mm
○ 1/1
FK-60

Fig.000
3,6 mm
○ 1/1
FK-61

Fig.00
4,4 mm
○ 1/1
FK-62

Fig.0
5,2 mm
○ 1/1
FK-63

Fig.1
6,8 mm
○ 1/1
FK-64

Fig.2
8,5 mm
○ 1/1
FK-65

Fig.3
10 mm
○ 1/1
FK-66

Fig.4
11,5 mm
○ 1/1
FK-67

Fig.5
13 mm
○ 1/1
FK-68

Fig.6
14,5 mm
○ 1/1
FK-69

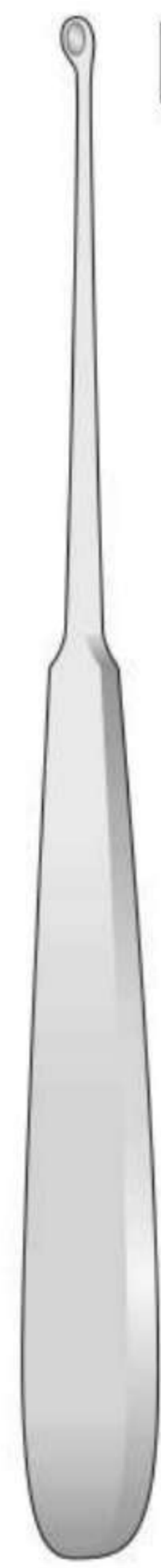

WILLIGER
FK-197/FK-198
170 mm



Fig. 00
3,4 mm
1/1
FK-197

Fig. 1
5,2 mm
1/1
FK-198

Biégsam
Malleable
Malleabile
Maleable
Souple



HALLE
FK-130/FK-132
215 mm

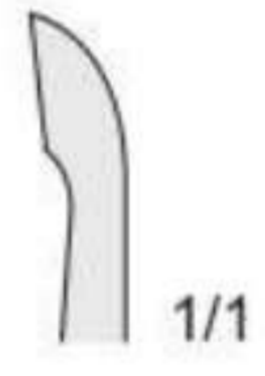
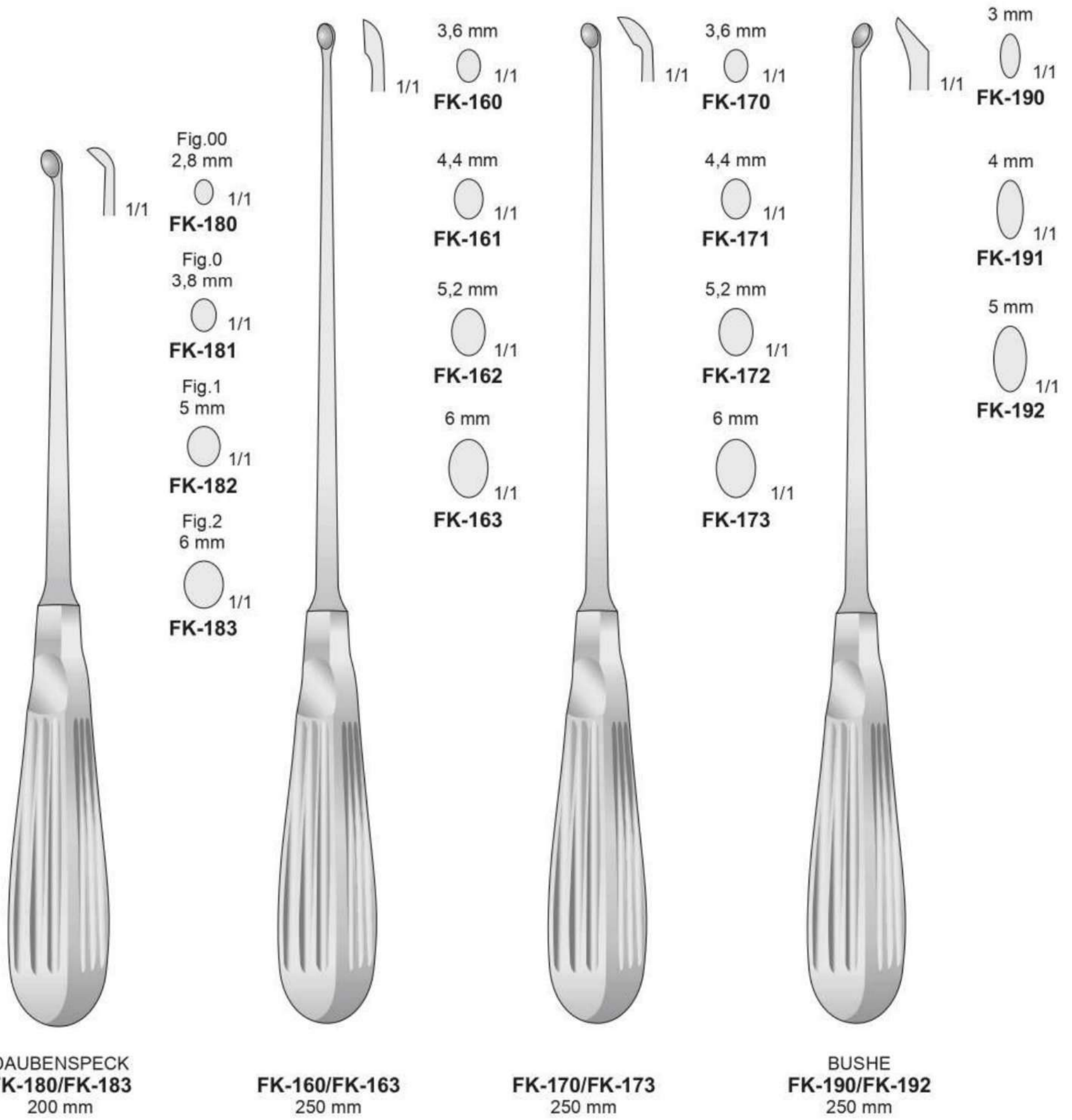
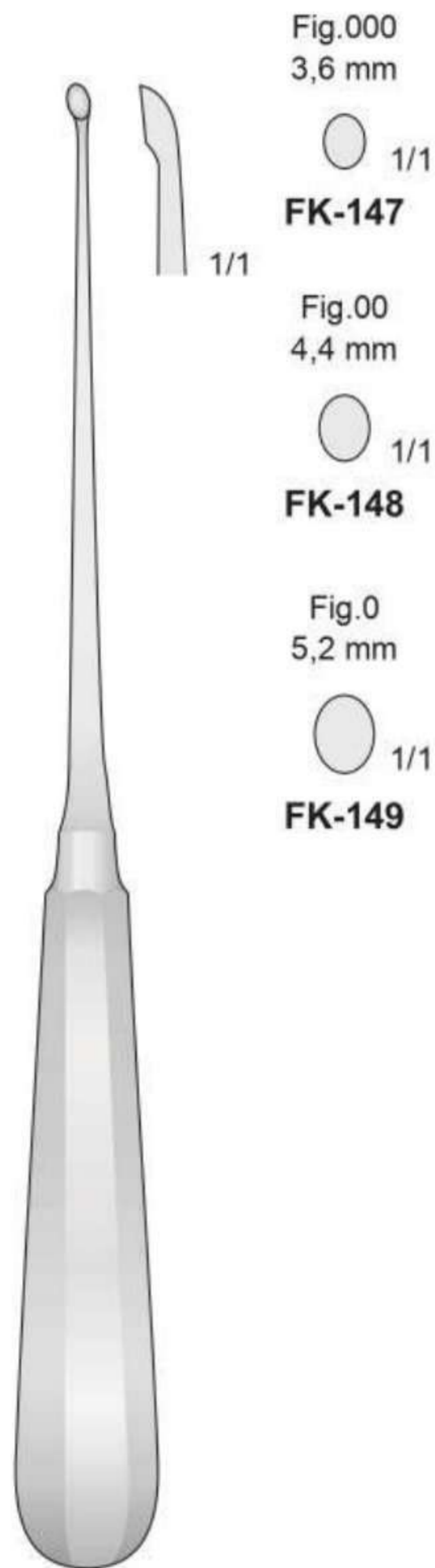

Fig.00
4,4 mm
1/1
FK-130

Fig.0
5,2 mm
1/1
FK-131

Fig.1
6,8 mm
1/1
FK-132





SIMON
FK-147/FK-149
235 mm

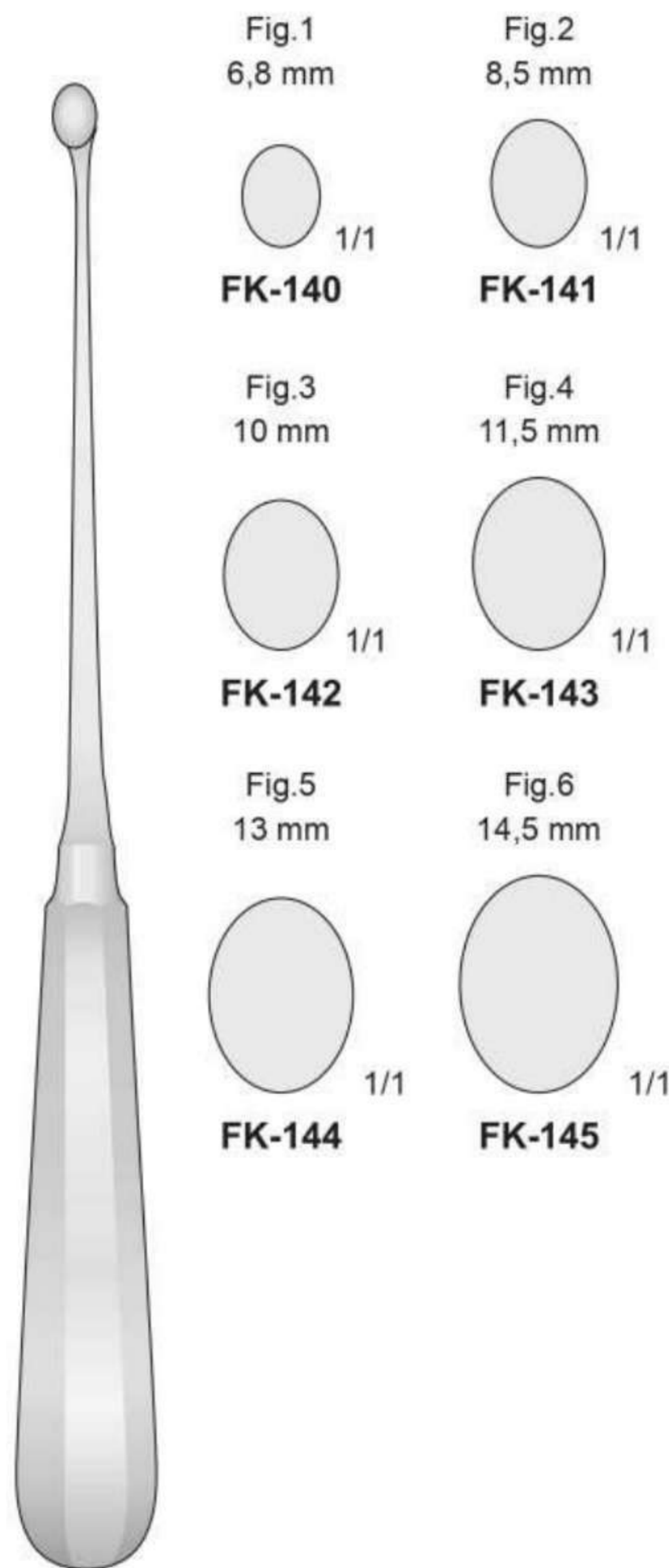

SIMON
FK-140/FK-145
240 mm

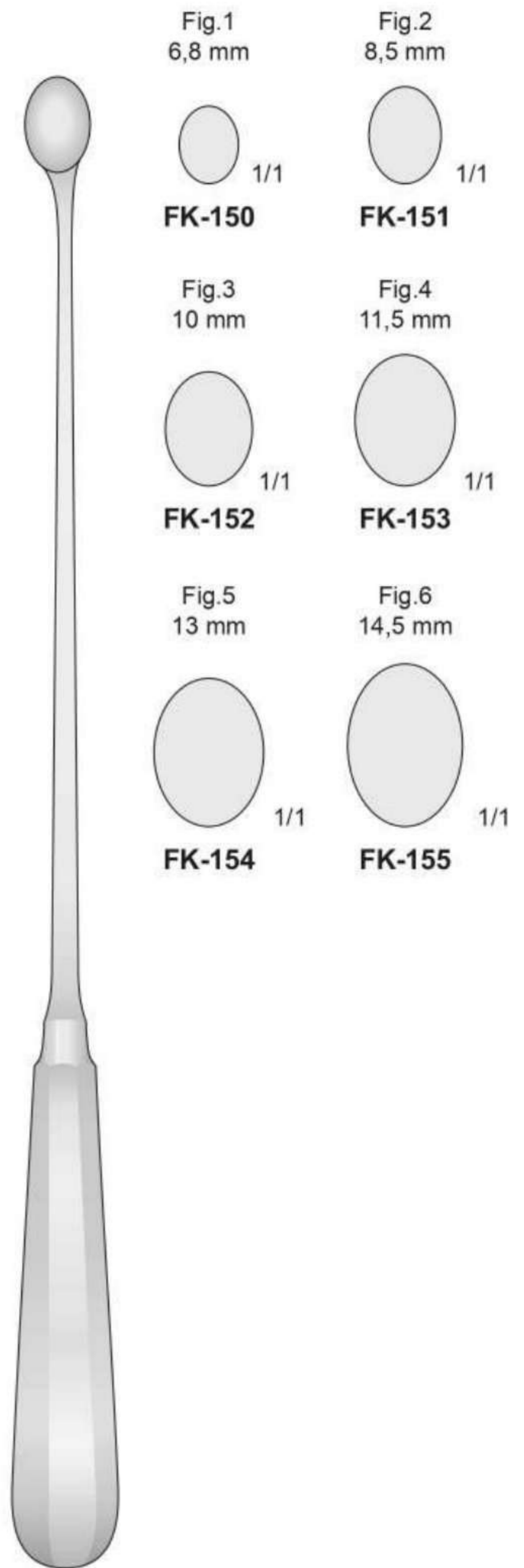

SCHRÖDER
FK-150/FK-155
310 mm

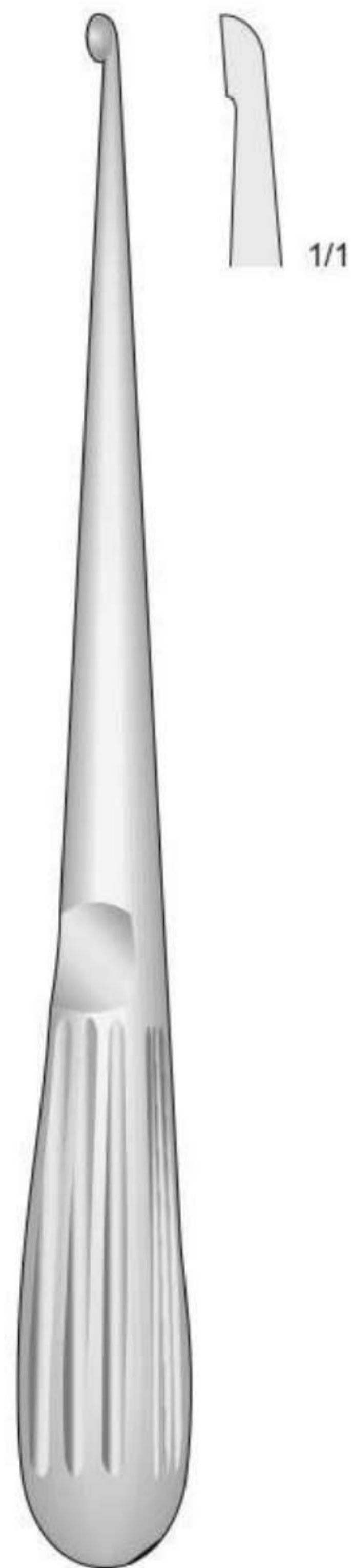

BRUNS
FK-280/FK-290
170 mm

Fig.5/0
2,2 mm



FK-280

Fig.4/0
2,5 mm



FK-281

Fig.3/0
2,8 mm



FK-282

Fig.2/0
3,3 mm

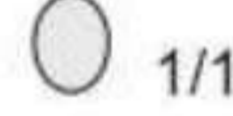

FK-283

Fig.0
3,6 mm



FK-284

Fig.1
4,3 mm



FK-285

Fig.2
4,8 mm



FK-286

Fig.3
5,6 mm



FK-287

Fig.4
6,0 mm



FK-288

Fig.5
6,7 mm



FK-289

Fig.6
8,8 mm



FK-290



BRUNS
FK-291/FK-299
225 mm

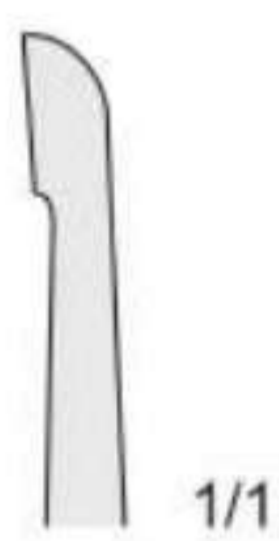

Fig.3/0
2,8 mm



1/1

FK-291

Fig.2/0
3,3 mm



1/1

FK-292

Fig.0
3,6 mm



1/1

FK-293

Fig.1
4,3 mm



1/1

FK-294

Fig.2
4,8 mm



1/1

FK-295

Fig.3
5,6 mm



1/1

FK-296

Fig.4
6,0 mm



1/1

FK-297

Fig.5
6,7 mm



1/1

FK-298

Fig.6
8,8 mm



1/1

FK-299



BRUNS
FK-300/FK-308
225 mm

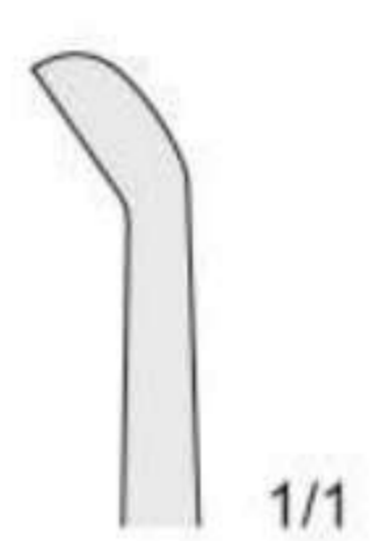
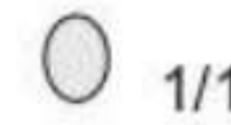

Fig.3/0
2,8 mm



1/1

FK-300

Fig.2/0
3,3 mm

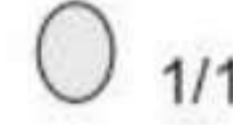

1/1

FK-301

Fig.0
3,6 mm



1/1

FK-302

Fig.1
4,3 mm



1/1

FK-303

Fig.2
4,8 mm



1/1

FK-304

Fig.3
5,6 mm



1/1

FK-305

Fig.4
6,0 mm



1/1

FK-306

Fig.5
6,7 mm



1/1

FK-307

Fig.6
8,8 mm



1/1

FK-308

Scharfe Küretten

Sharp curettes

Curette taglienti

Cucharillas cortantes

Curettes tranchantes

Mit Ferrozellgriff - With Ferrozell handle
Con manico Ferrozell - Con mango de Ferrozell
Avec manche en Ferrozell



SYPERT
FK-310/FK-313
380 mm

Fig.0000
2,8 mm
1/1
FK-310

Fig.0
5,2 mm
1/1
FK-312

Fig.000
3,6 mm
1/1
FK-311

Fig.3
10,0 mm
1/1
FK-313



SYPERT
FK-314/FK-317
380 mm

Fig.0000
2,8 mm
1/1
FK-314

Fig.0
5,2 mm
1/1
FK-316

Fig.000
3,6 mm
1/1
FK-315

Fig.3
10,0 mm
1/1
FK-317

Scharfe Küretten

Sharp curettes

Curette taglienti

Cucharillas cortantes

Curettes tranchantes

Mit Ferrozellgriff - With Ferrozell handle
Con manico Ferrozell - Con mango de Ferrozell
Avec poignée en Ferrozell

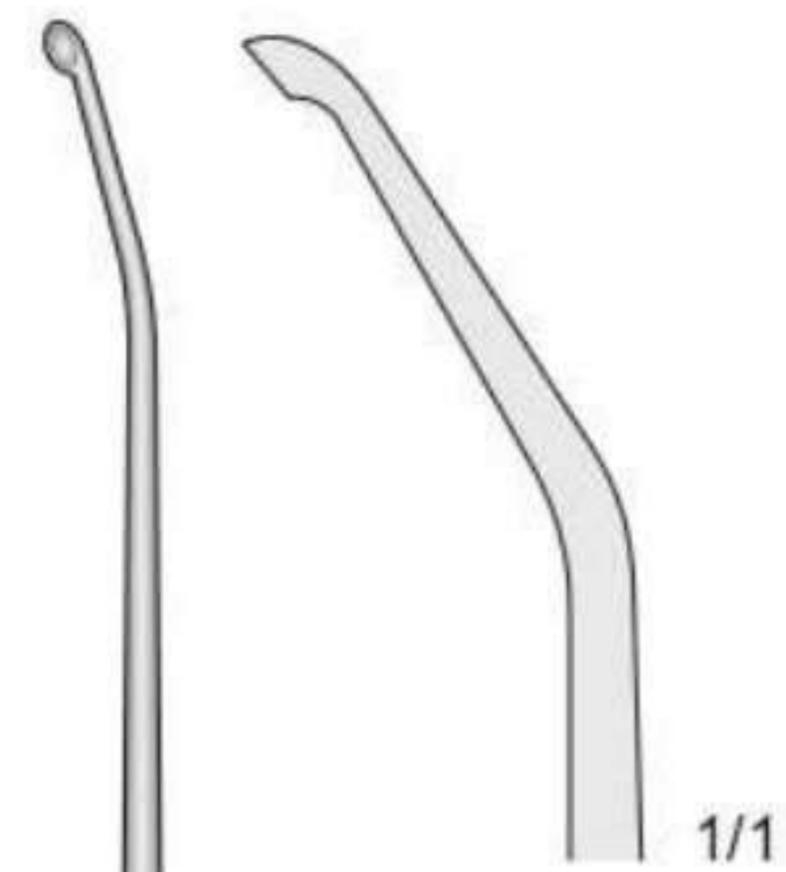

Fig.0000
2,8 mm
1/1
FK-318

Fig.000
3,6 mm
1/1
FK-319



SYPERT
FK-318/FK-319
420 mm

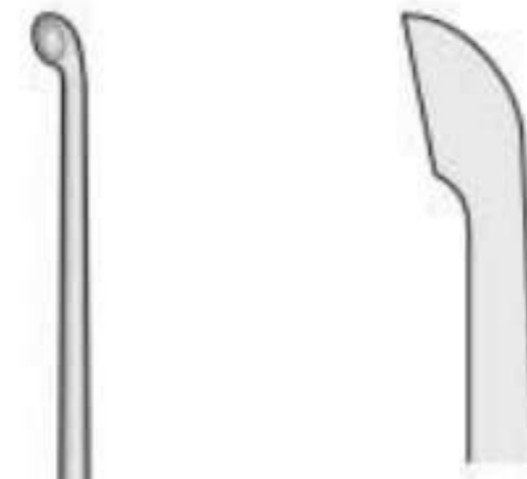

Fig.000
3,6 mm
1/1
FK-320

Fig.00
4,4 mm
1/1
FK-321

Fig.0
5,2 mm
1/1
FK-322



FK-320/FK-322
410 mm

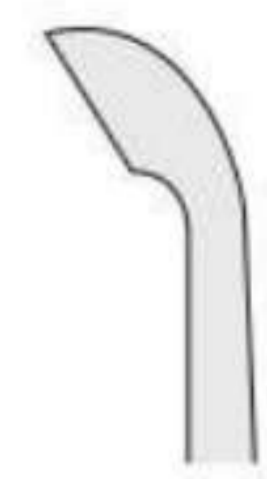

Fig.000
3,6 mm
1/1
FK-323

Fig.00
4,4 mm
1/1
FK-324

Fig.0
5,2 mm
1/1
FK-325



FK-323/FK-325
410 mm

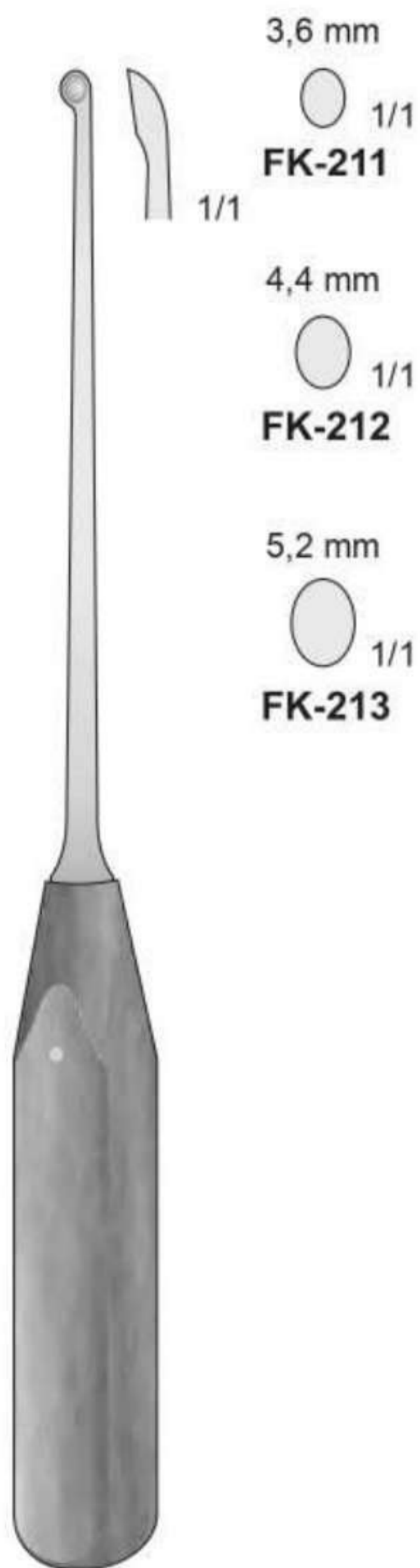

CASPAR
FK-211/FK-213
220 mm

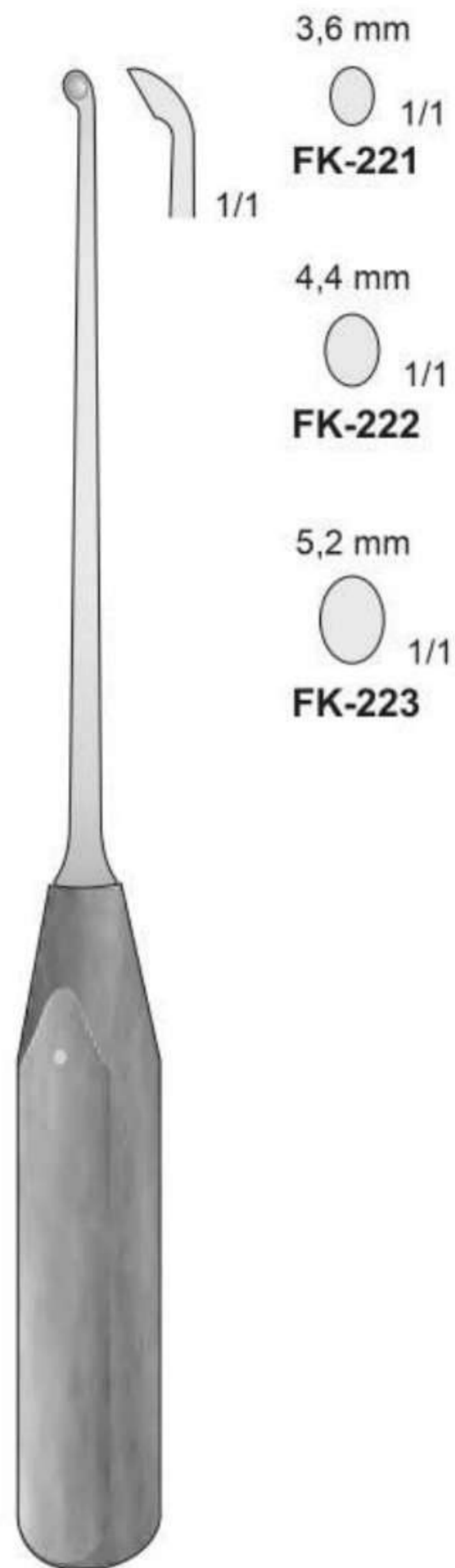

CASPAR
FK-221/FK-223
220 mm

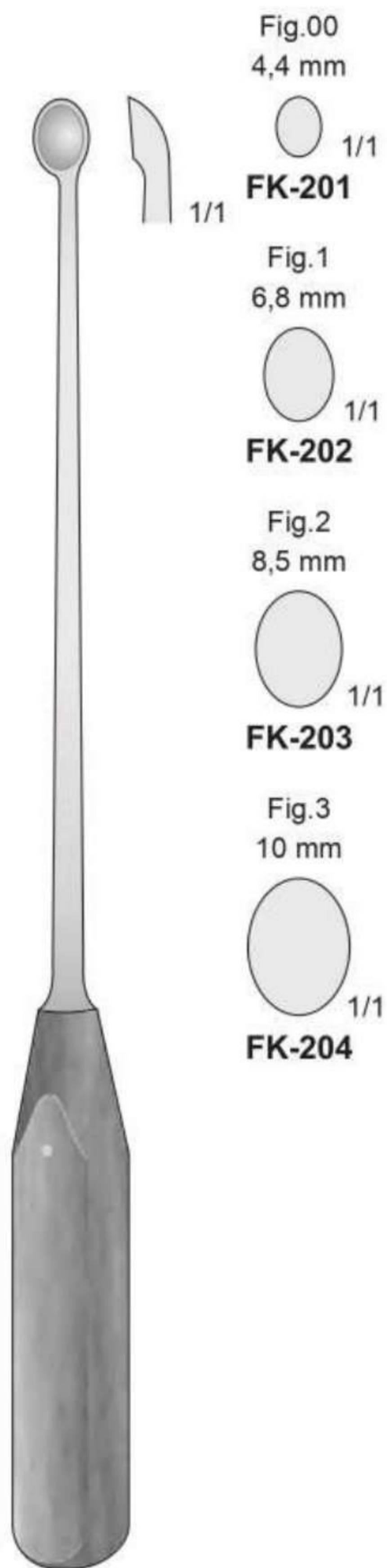

FK-201/FK-204
270 mm

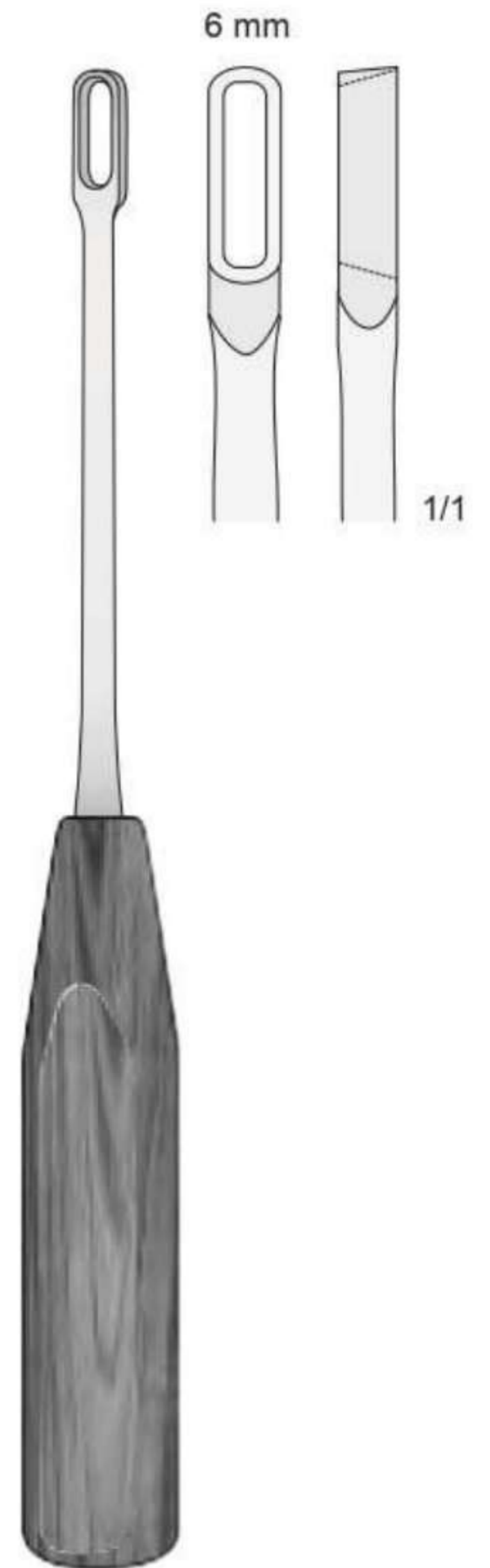

TESSIER
FL-198
220 mm

Scharfe Küretten

Sharp curettes

Curette taglienti

Cucharillas cortantes

Curettes tranchantes

Femoral prosthesis instrumentation
Strumentario per protesi femorale
Instruments pour prothese femorale

Mit Ferrozellgriff
With Ferrozell handle
Con manico Ferrozell
Con mango de Ferrozell
Avec poignée en Ferrozell

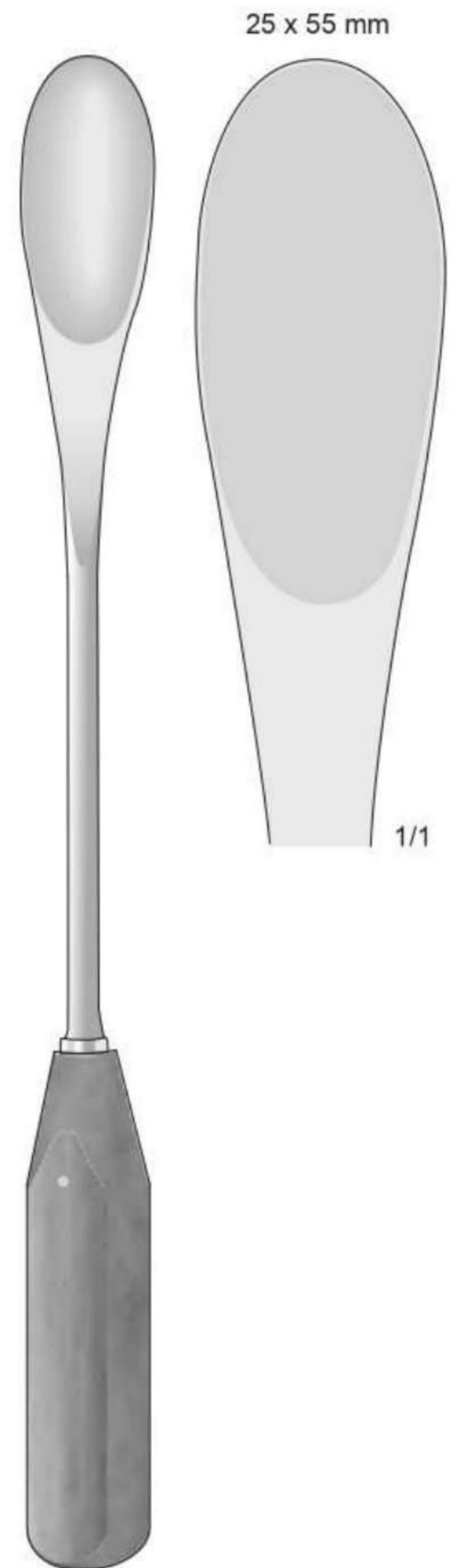
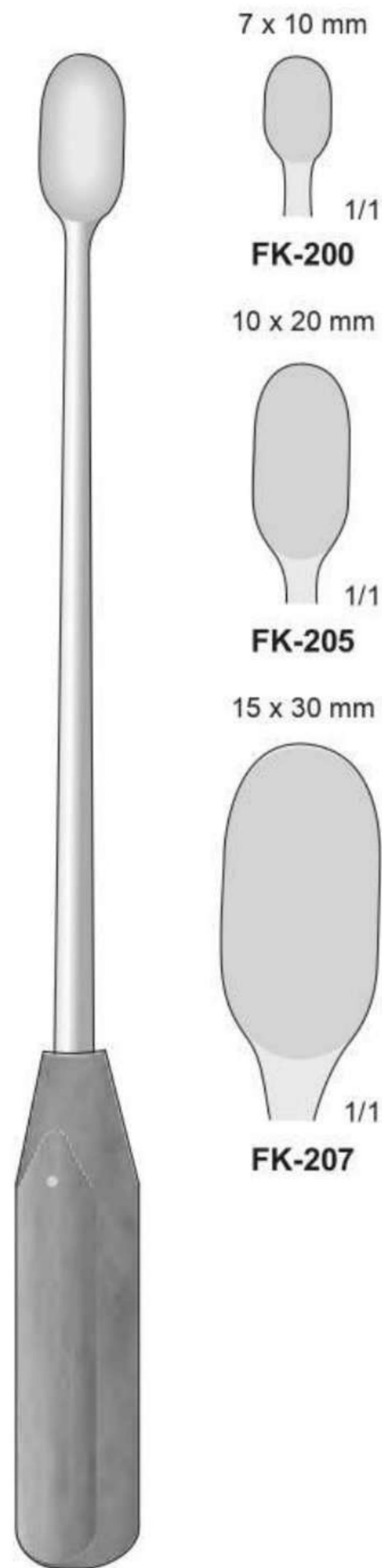
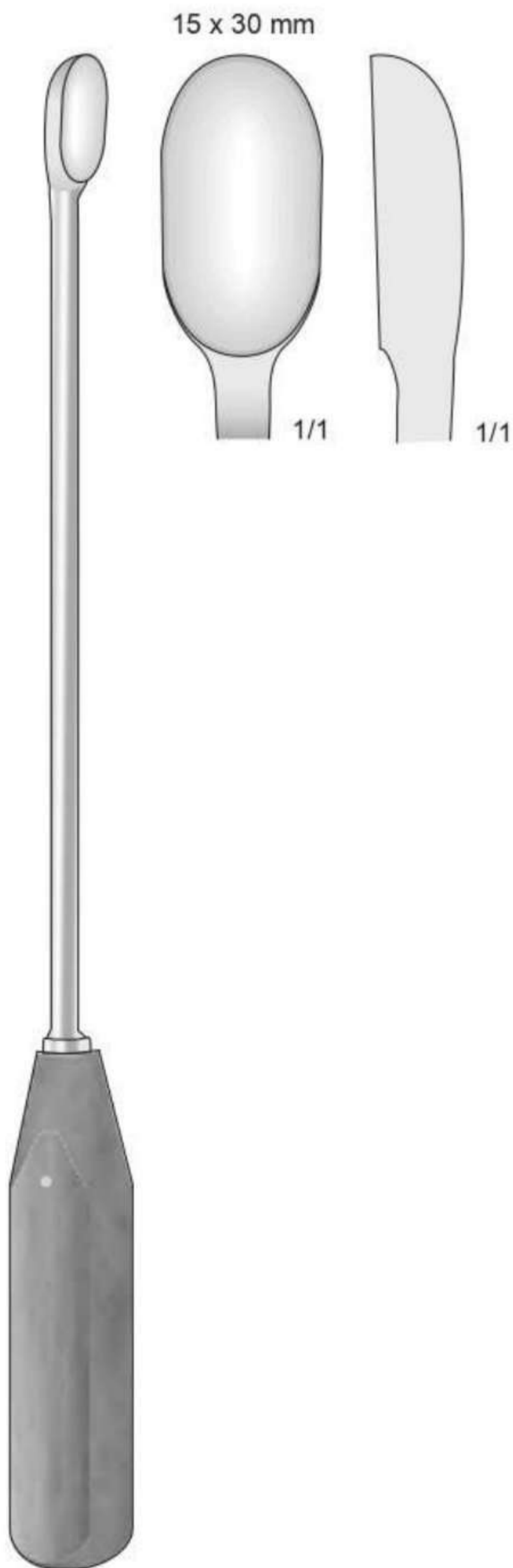



TRS

INSTRUMENTS

TRAUMATOLOGY

AND

ORTHOPAEDICS

Surgical Mallets

Chirurgische Hämmer
Maillets chirurgicaux
Martillos quirúrgicos
Martelli chirurgici

Tampers

Stößels
Compacteurs
Compactadores
Compattatori

Osteotomes

Osteotome
Ostéotomes
Osteótomos
Osteotomi

Chisels

Meißeln
Burins
Cinceles
Scalpelli

Chirurgische Hämmer

Surgical mallets

Martelli chirurgici

Martillos quirurgicos

Maillets chirurgicaux

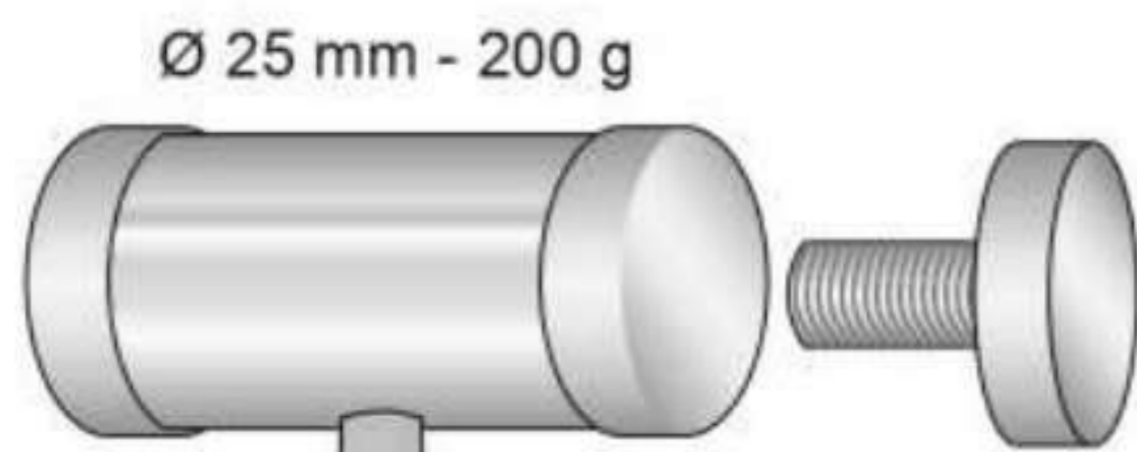

MEAD
FL-11
200 mm

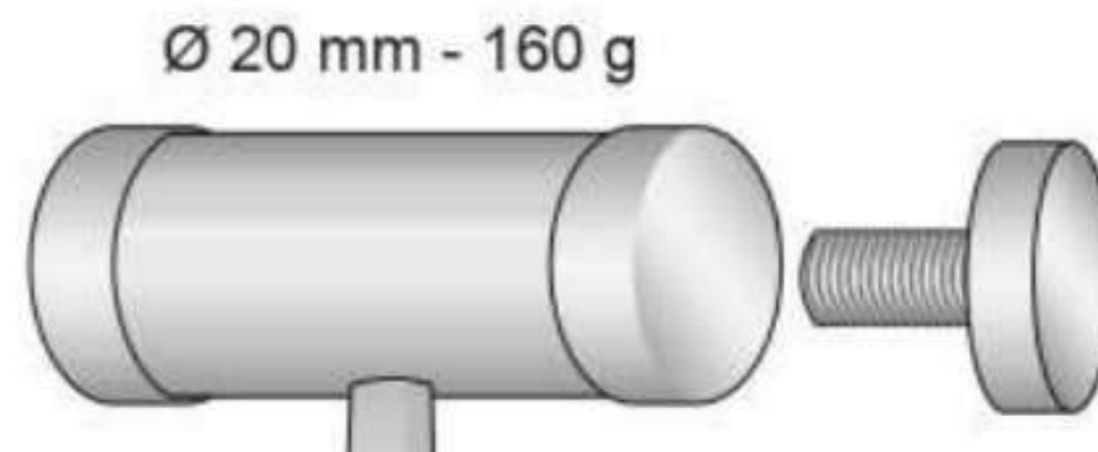

MEAD
FL-09
190 mm



MEAD
FL-12
190 mm

FL-11R

Paar Ersatzbacken
Pair of spare faces
Coppia di teste
di ricambio
Pareja de tapas
intercambiables
Paire de faces
de rechange

FL-09R

Paar Ersatzbacken
Pair of spare faces
Coppia di teste
di ricambio
Pareja de tapas
intercambiables
Paire de faces
de rechange

FL-12R

Paar Ersatzbacken
Pair of spare faces
Coppia di teste
di ricambio
Pareja de tapas
intercambiables
Paire de faces
de rechange

Ø 20 mm - 140 g



FL-01
165 mm

Ø 25 mm - 300 g

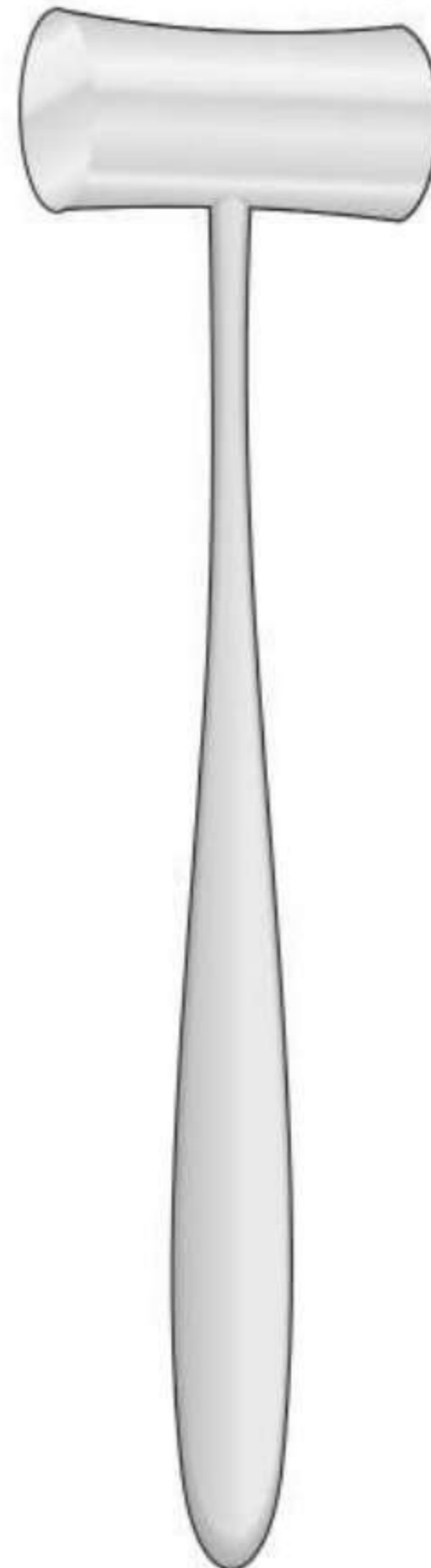

LUCAE
FL-10M
190 mm

Ø 20 mm - 240 g

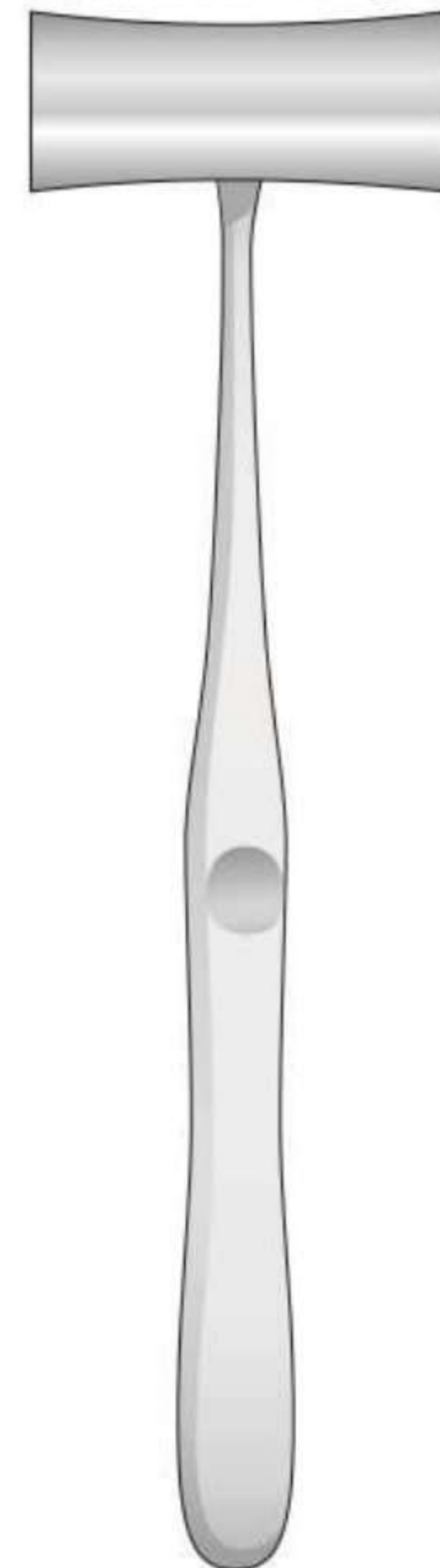

WILLIGER
FL-02
240 mm

1 Seite flach - 1 Seite convex
1 Side flat - 1 Side convex
1 Lato piatto - 1 Lato convesso
1 Parte plana - 1 Parte convexe
1 Face plate - 1 Face convexe

Ø 30 mm - 240 g



COTTLE
FL-104
185 mm

Ø 30 mm - 300 g



BERGMANN
FL-105
235 mm

Ø 45 mm - 300 g



BERGMANN
FL-106
245 mm



FL-107
240 mm



OMBREDANNE
FL-108
240 mm



HEATH
FL-109
185 mm

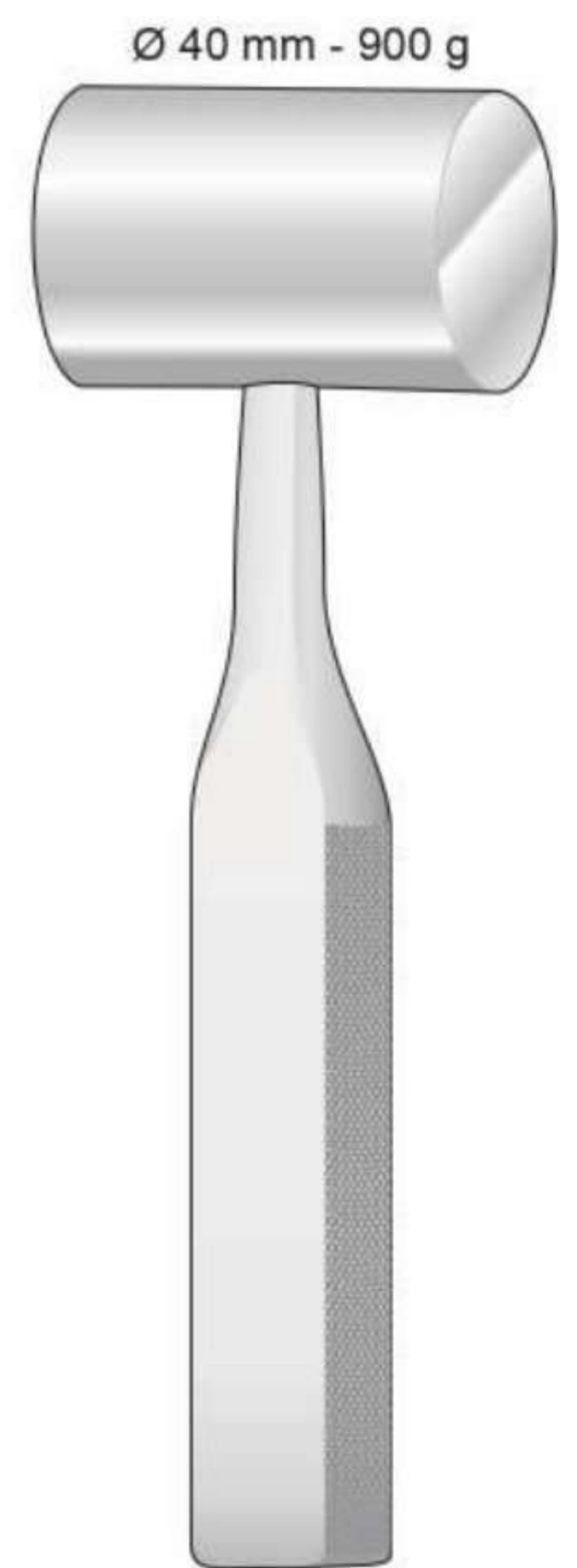

FL-112
190 mm

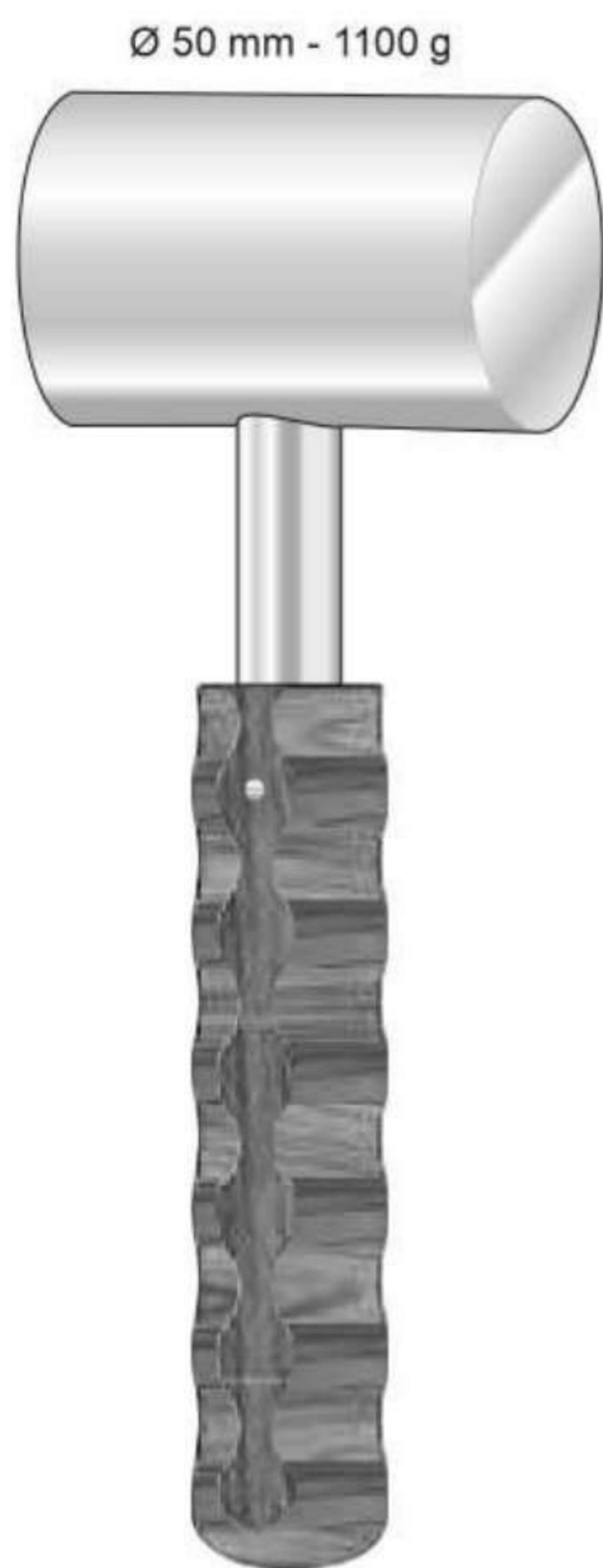

FL-111
200 mm



FL-06
260 mm



FL-113
270 mm

Stößels

Tampers

Compattatori

Compactadores

Compacteurs



-  **FF-147**
Ø3 mm
-  **FF-148**
Ø5 mm
-  **FF-149**
Ø8 mm





CASPAR
FF-147/FF-149
200 mm



-  **FL-253**
Ø12 mm
-  **FL-254**
Ø14 mm
-  **FL-255**
Ø16 mm

FL-253/FL-255
200 mm



-  **FL-256**
3x8 mm
-  **FL-257**
4x10 mm
-  **FL-258**
5x15 mm
-  **FL-259**
6x20 mm

SYPERT
FL-256/FL-259
290 mm

Osteotome
Stößels

Osteotomi
Compattatori

Osteotomes
Tampers

Ostéotomes
Compacteurs

Osteótomos
Compactadores

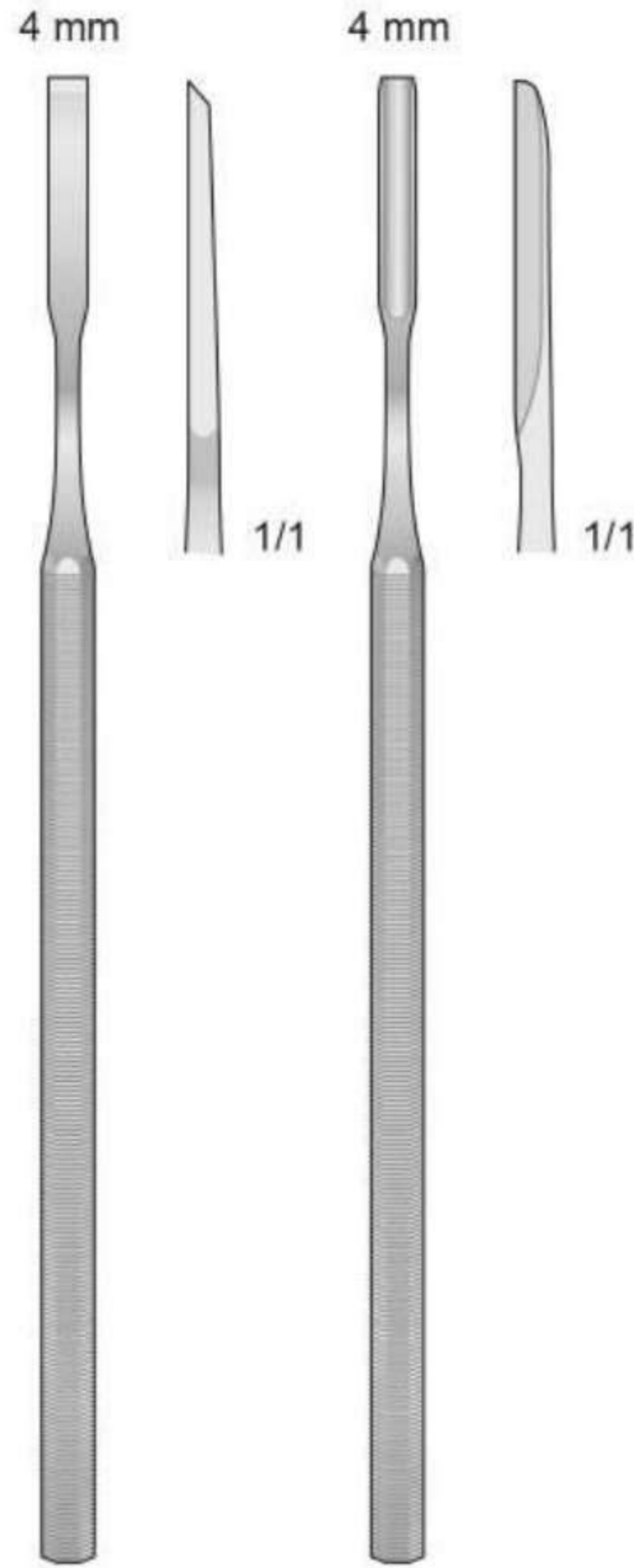

BUCKLEY
TG-40
160 mm

BUCKLEY
TG-41
160 mm

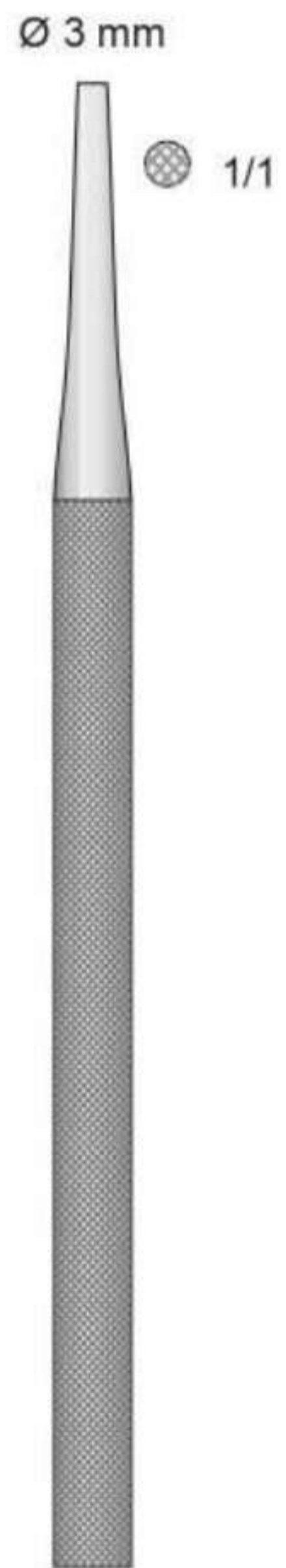

FL-20
155 mm

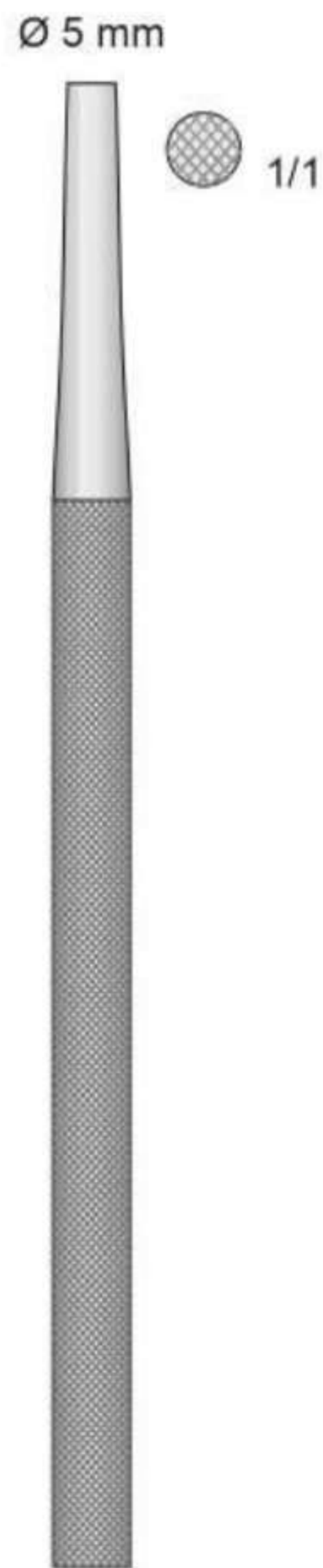

FL-21
155 mm

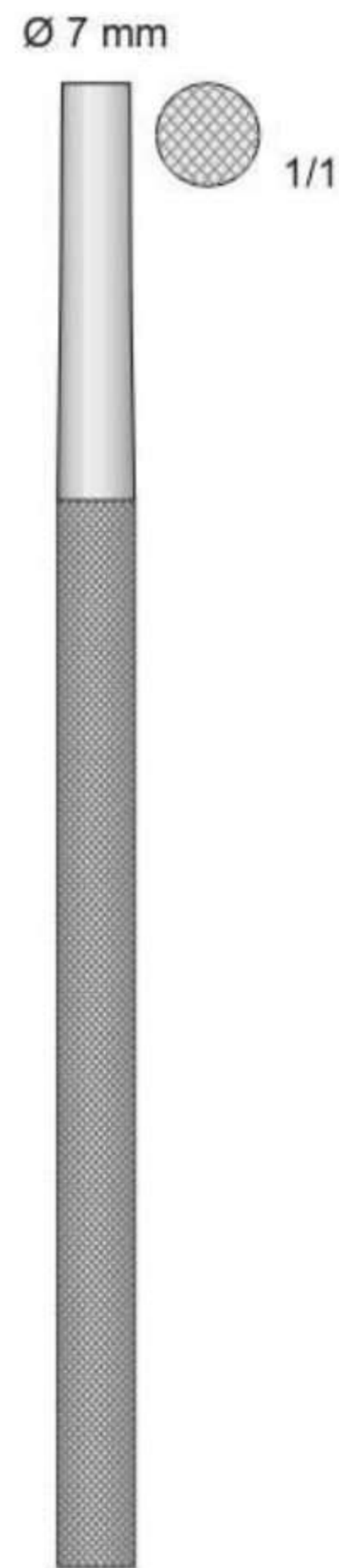

FL-22
155 mm



FL-30
155 mm

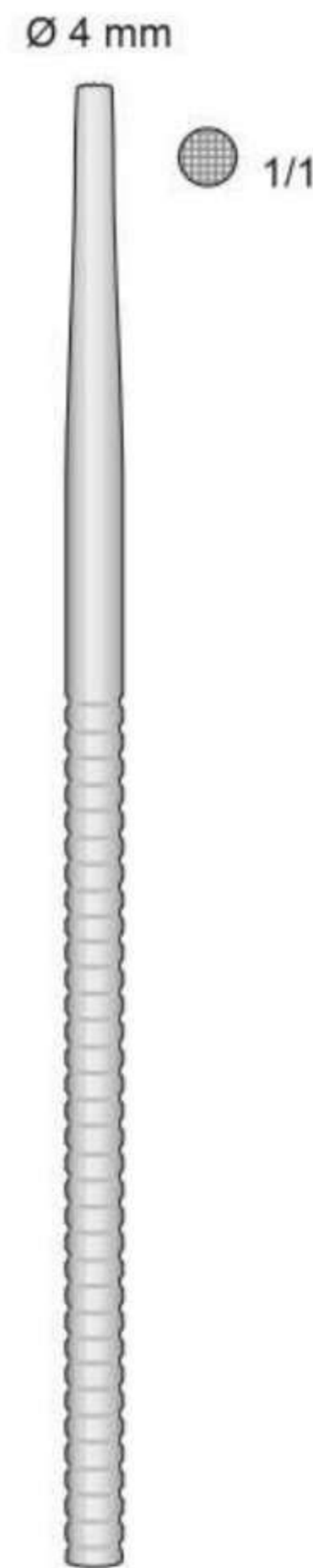

FL-31
155 mm



FL-33
155 mm

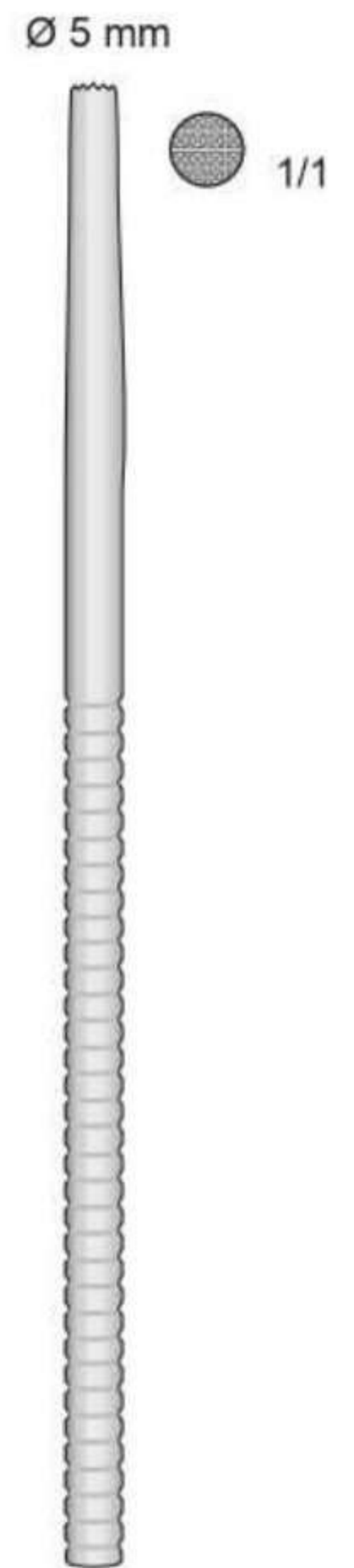

FL-35
155 mm

Osteotome
Meißeln

Osteotomes
Chisels

Osteotomi
Scalpelli

Osteótomos
Cinceles

Ostéotomes
Burins

Osteotome -Osteotomes
Osteotomi - Osteótomos - Ostéotomes

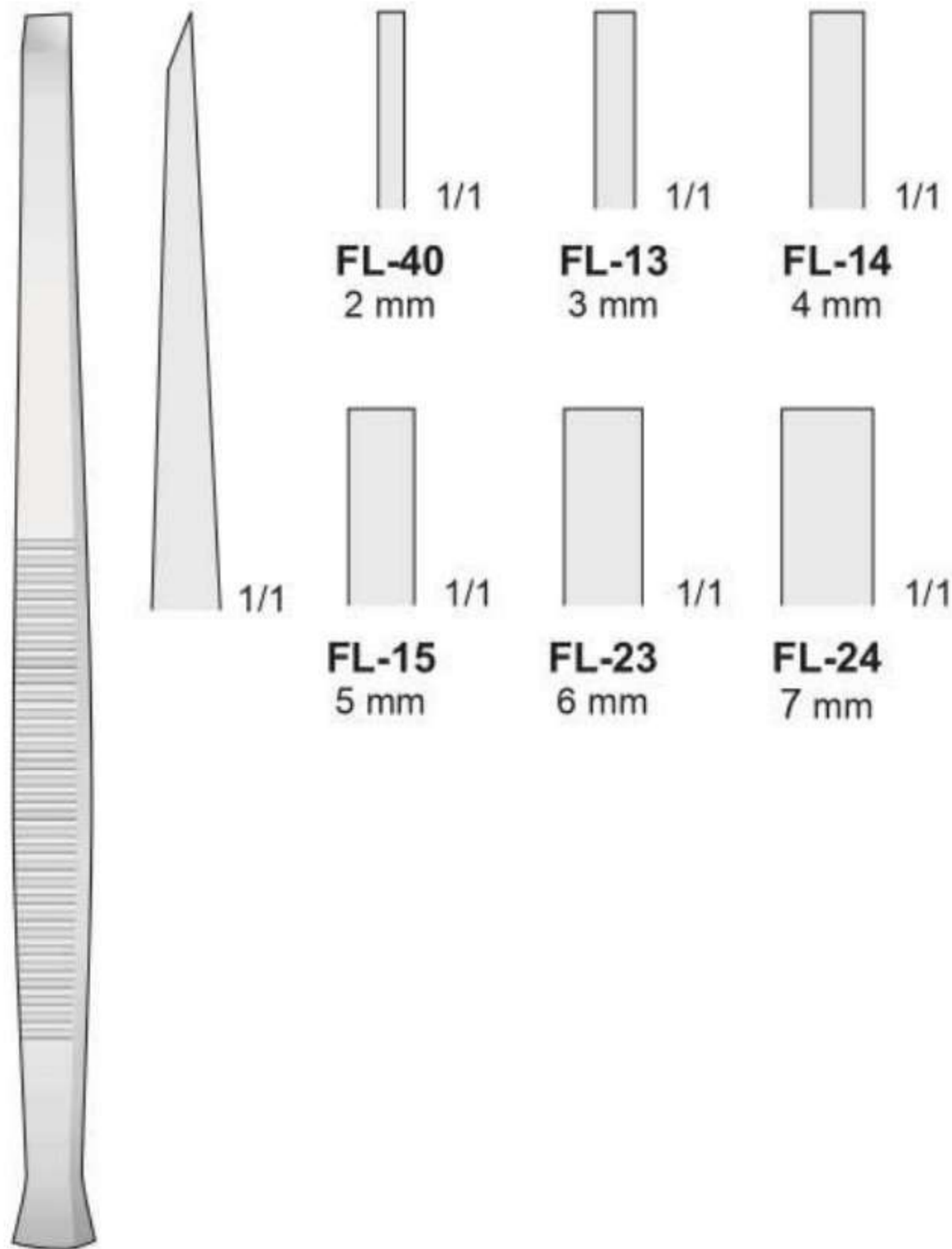

PARTSCH
FL-13/FL-40
140 mm

Hohlmeißel - Gouges
Sgorbie - Gubias - Gouges

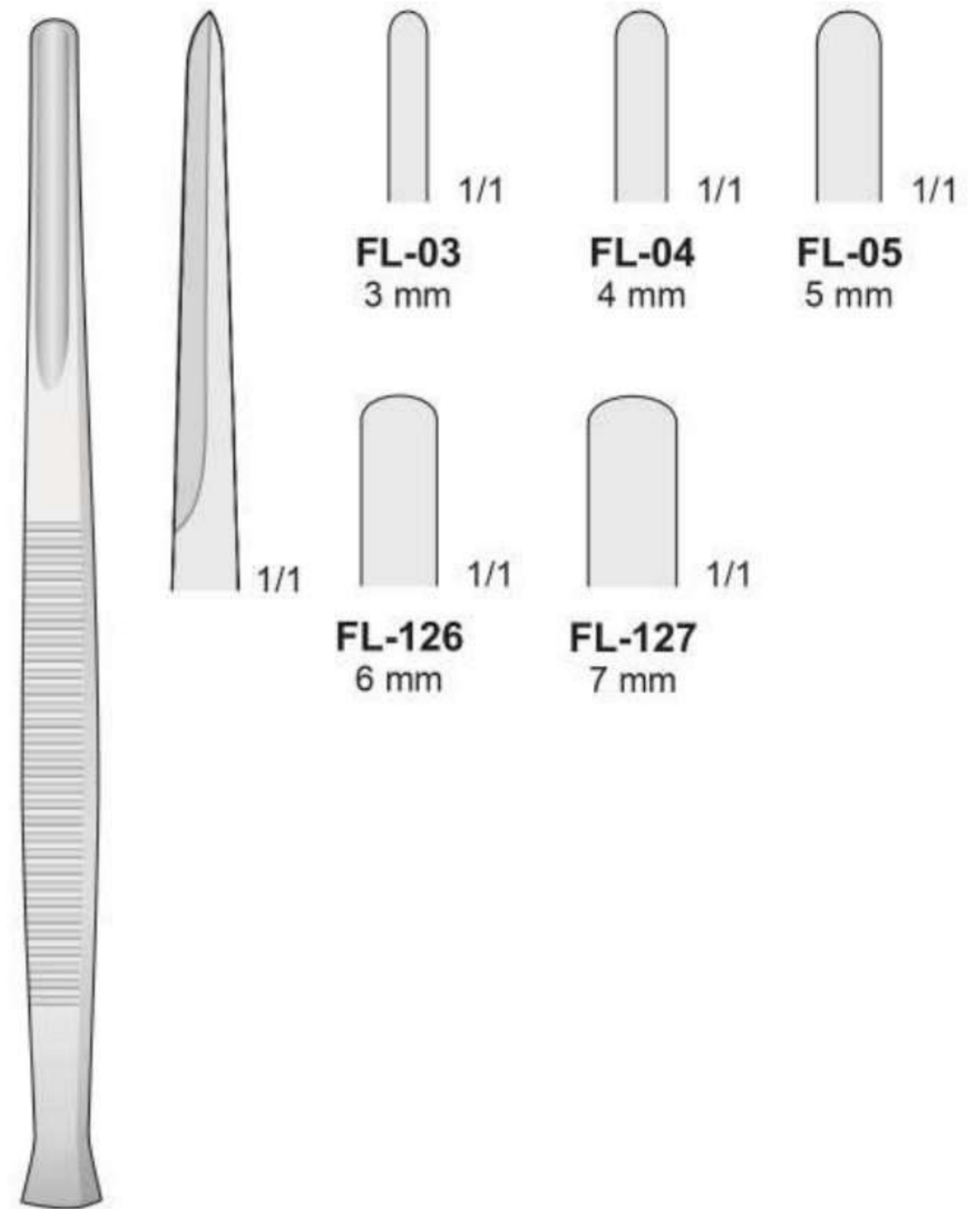

PARTSCH
FL-03/FL-127
140 mm

Osteotome -Osteotomes
Osteotomi - Osteótomos - Ostéotomes

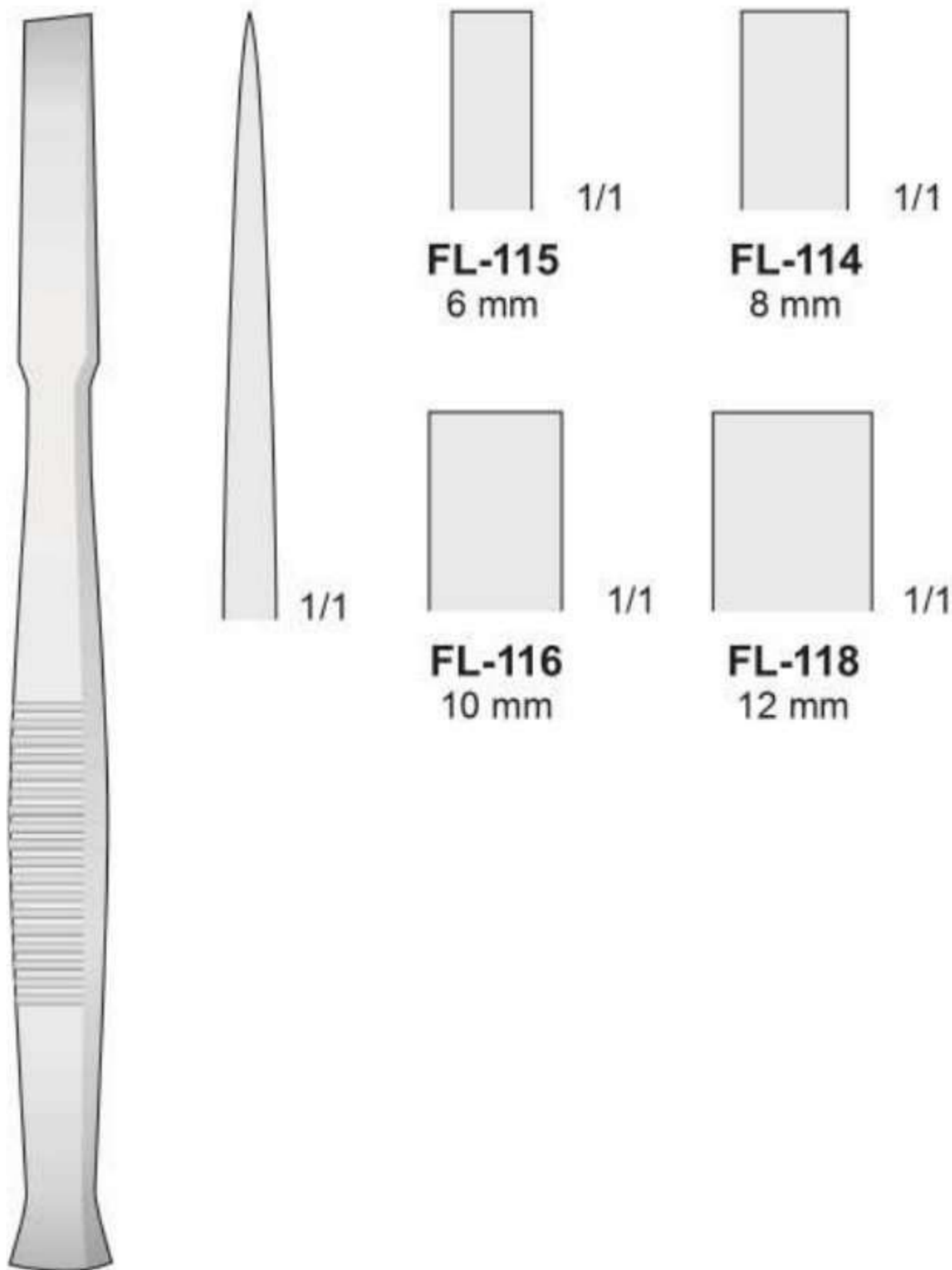

FL-114/FL-118
140 mm

Hohlmeißel - Gouges
Sgorbie - Gubias - Gouges

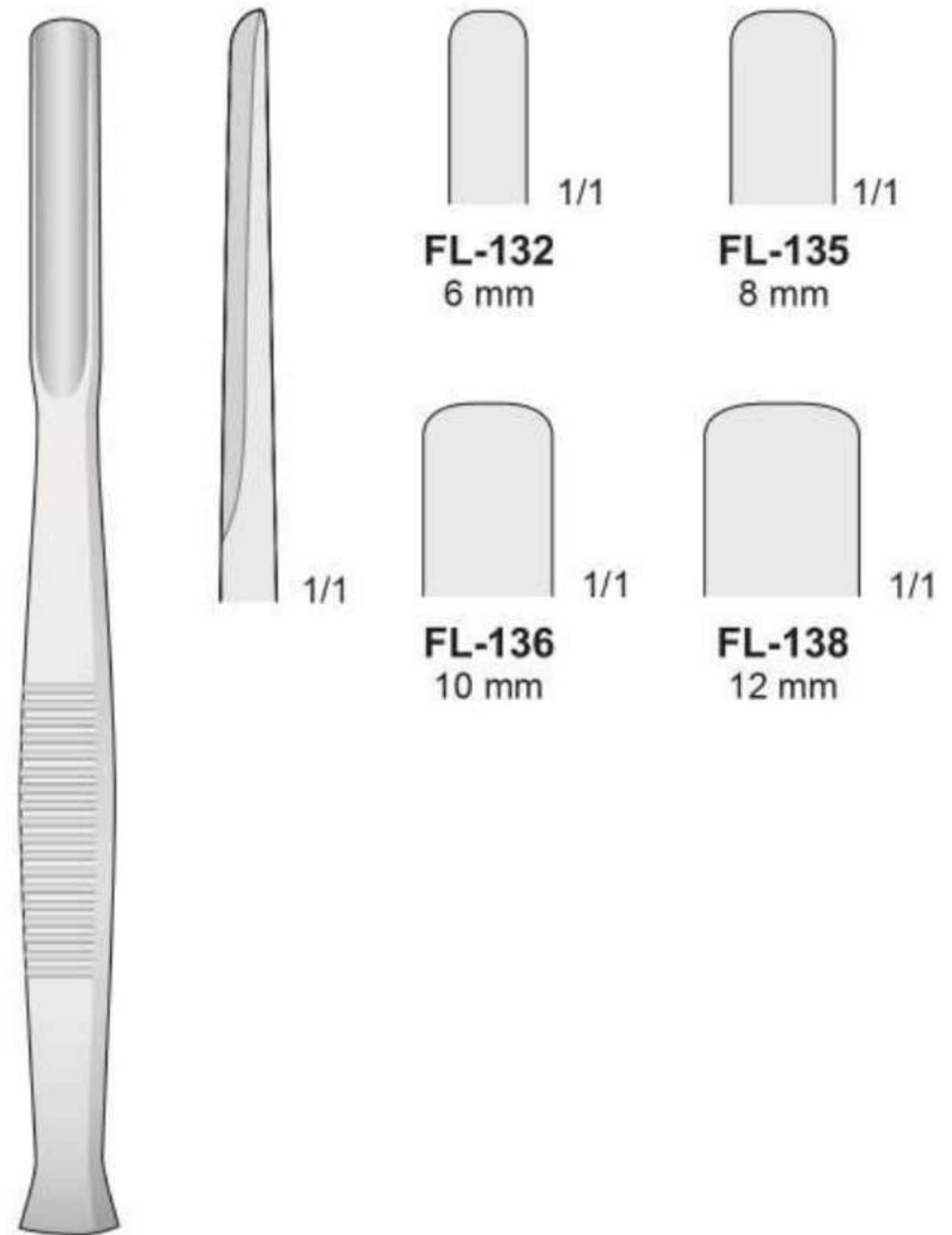

FL-132/FL-138
140 mm

Osteotome
Meißeln

Osteotomes
Chisels

Osteotomi
Scalpelli

Osteótomos
Cinceles

Ostéotomes
Burins

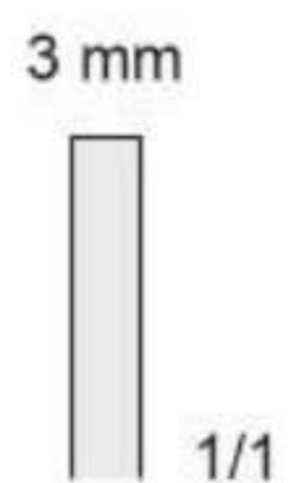

FL-177

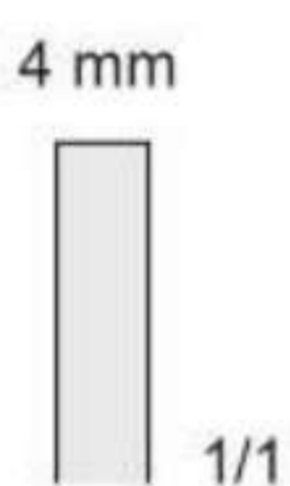

FL-179

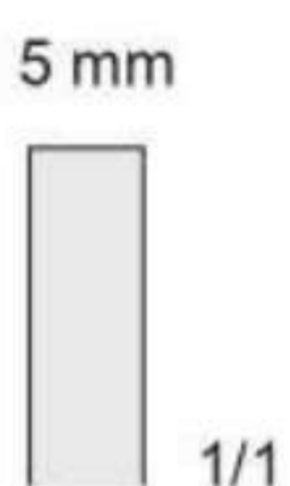

FL-181

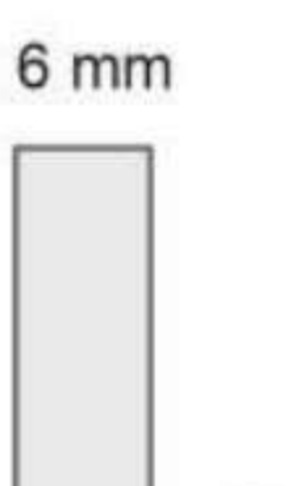

FL-183



FL-184

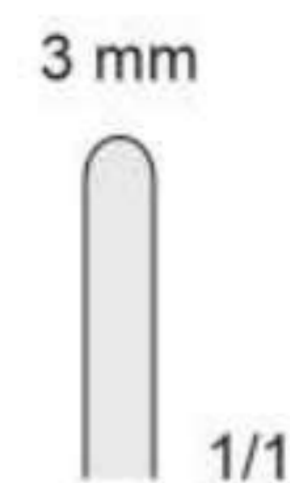

FL-185

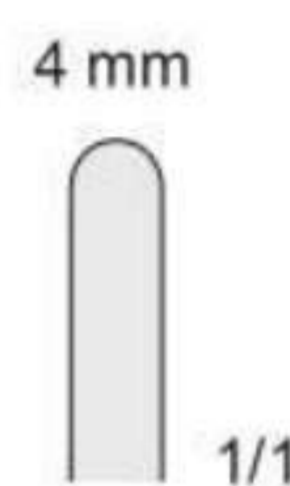

FL-186

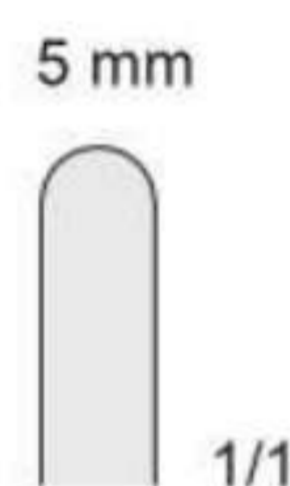

FL-187

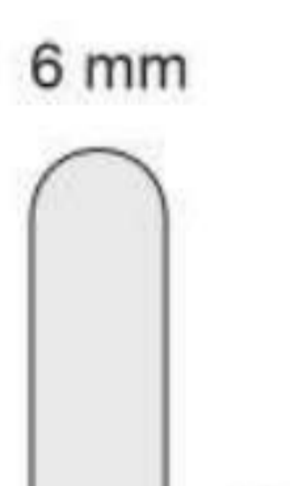

FL-188

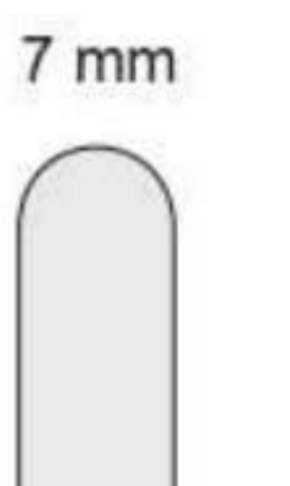

FL-189



PARTSCH
FL-177/FL-184
170 mm



PARTSCH
FL-185/FL-189
170 mm

Meißeln

Chisels

Scalpelli

Cinceles

Burins

8 mm



COSCIA
FL-368
180 mm

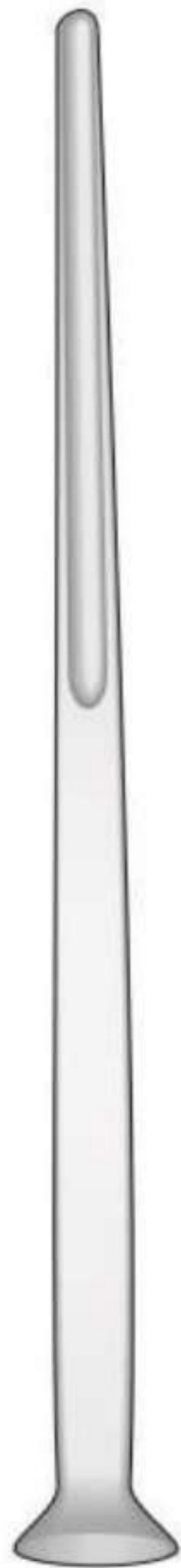

ALEXANDER
FL-206/FL-209
170 mm

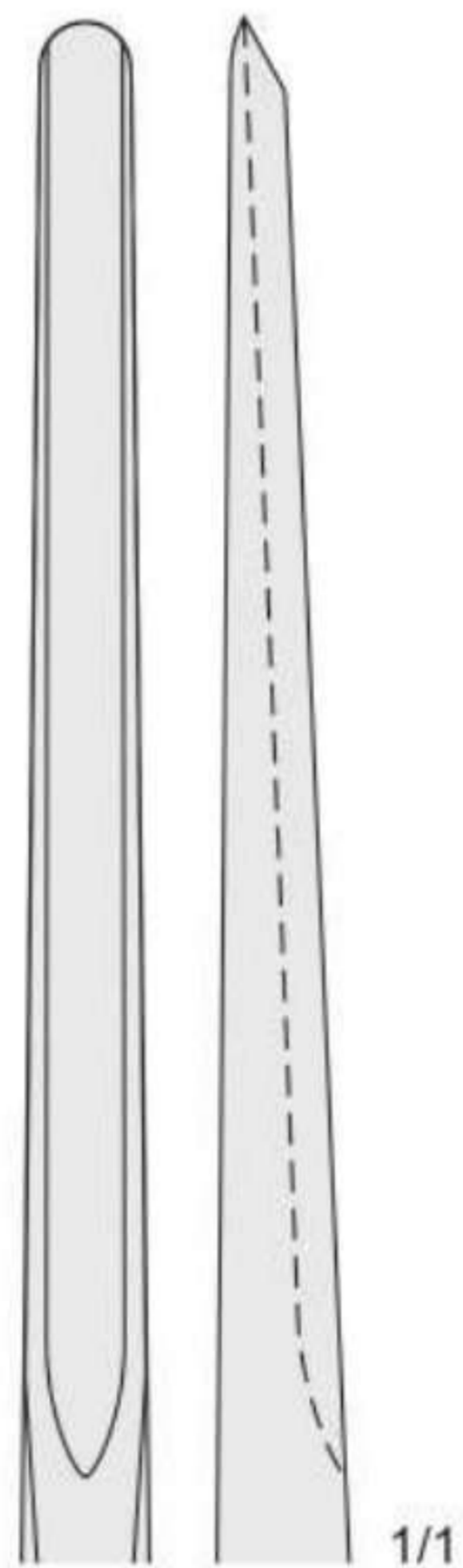

FL-206
5 mm

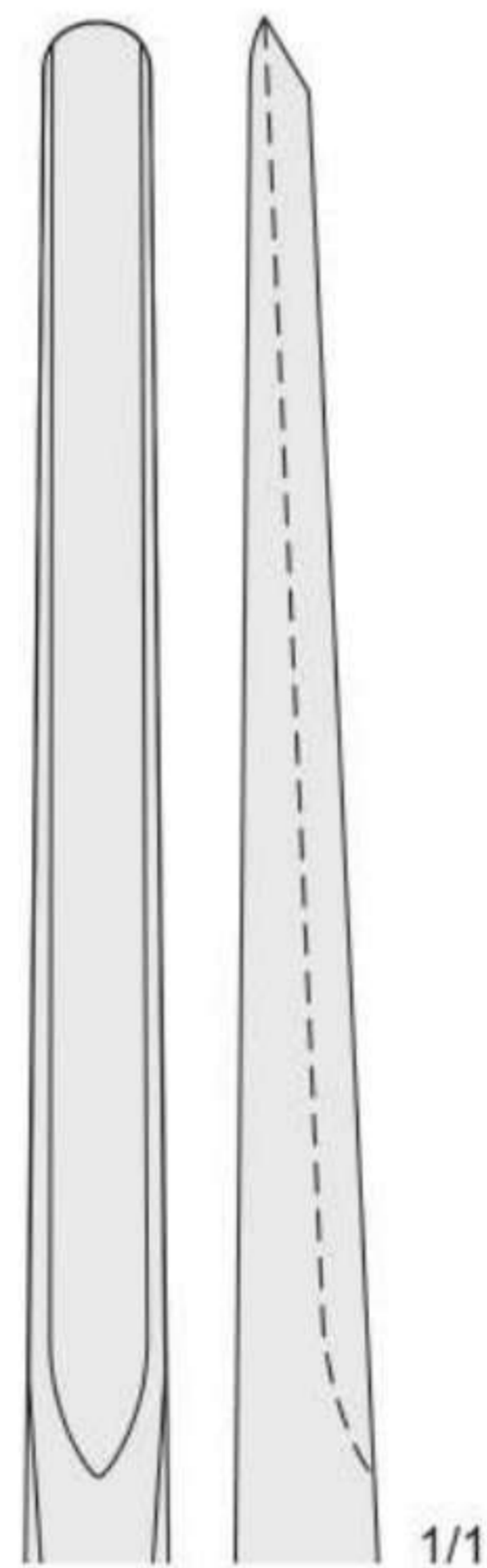

FL-207
7 mm

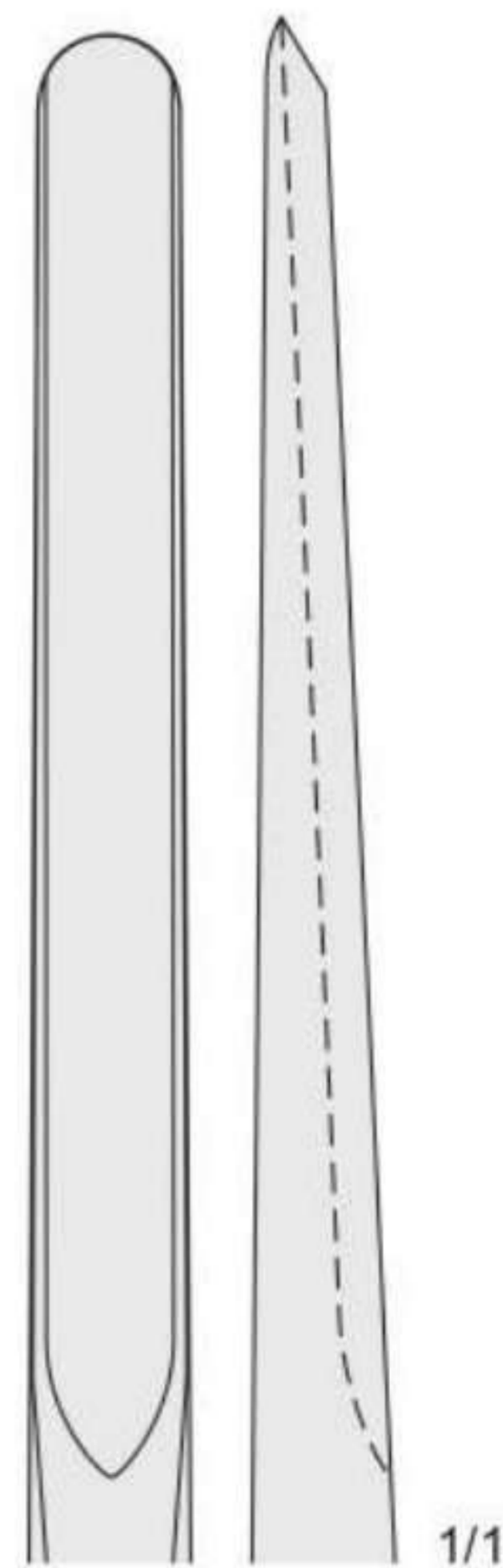

FL-208
9 mm

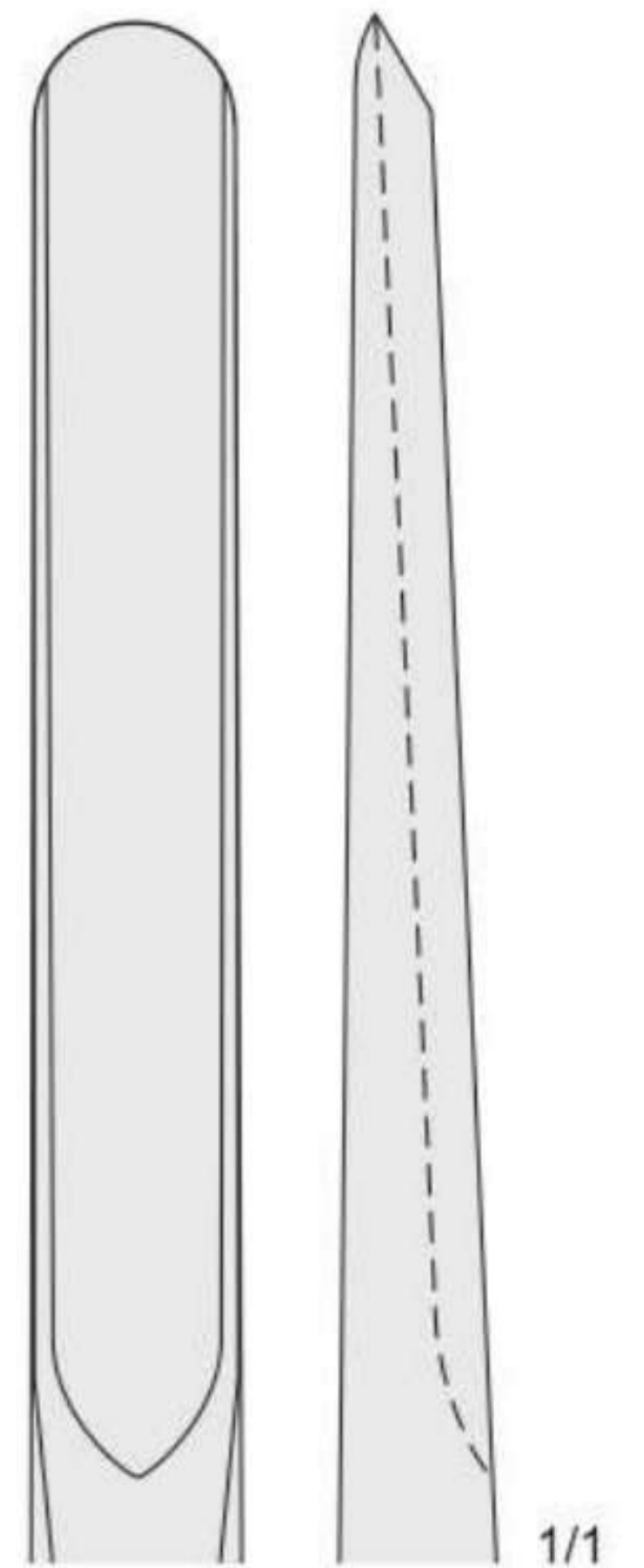

FL-209
11 mm

Osteotome

Osteotomes

Osteotomi

Osteótomos

Ostéotomes



MINI-LAMBOTTE
FL-16/FL-58
125 mm



1/1

3 mm



1/1

FL-53

4 mm



1/1

FL-16

6 mm



1/1

FL-17

8 mm



1/1

FL-18

10 mm



1/1

FL-32

12 mm

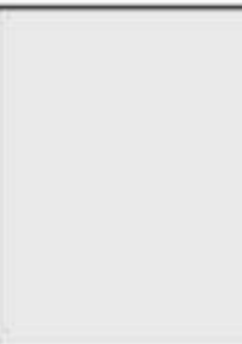

1/1

FL-54

15 mm

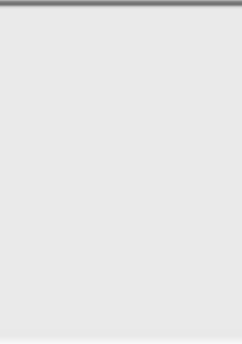

1/1

FL-58



MINI-LAMBOTTE
FL-263/FL-269
170 mm



1/1

3 mm



1/1

FL-263

4 mm



1/1

FL-264

6 mm



1/1

FL-265

8 mm



1/1

FL-266

10 mm



1/1

FL-267

12 mm



1/1

FL-268

15 mm

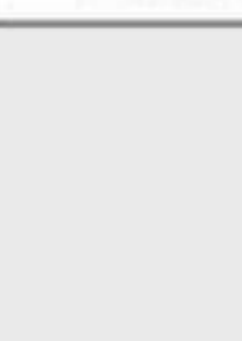

1/1

FL-269

Osteotome

Osteotomes

Osteotomi

Osteótomos

Ostéotomes



- FL-41** 4 mm
- FL-29** 8 mm
- FL-42** 10 mm
- FL-34** 13 mm
- FL-43** 15 mm
- FL-36** 18 mm
- FL-44** 20 mm
- FL-45** 25 mm
- FL-46** 30 mm
- FL-47** 38 mm
- FL-48** 44 mm
- FL-49** 50 mm

LAMBOTTE
FL-41/FL-49
250 mm



- FL-94** 8 mm
- FL-95** 13 mm
- FL-96** 18 mm
- FL-97** 25 mm
- FL-98** 30 mm
- FL-99** 38 mm

LAMBOTTE
FL-94/FL-99
250 mm

Osteotome

Osteotomes

Osteotomi

Osteótomos

Ostéotomes

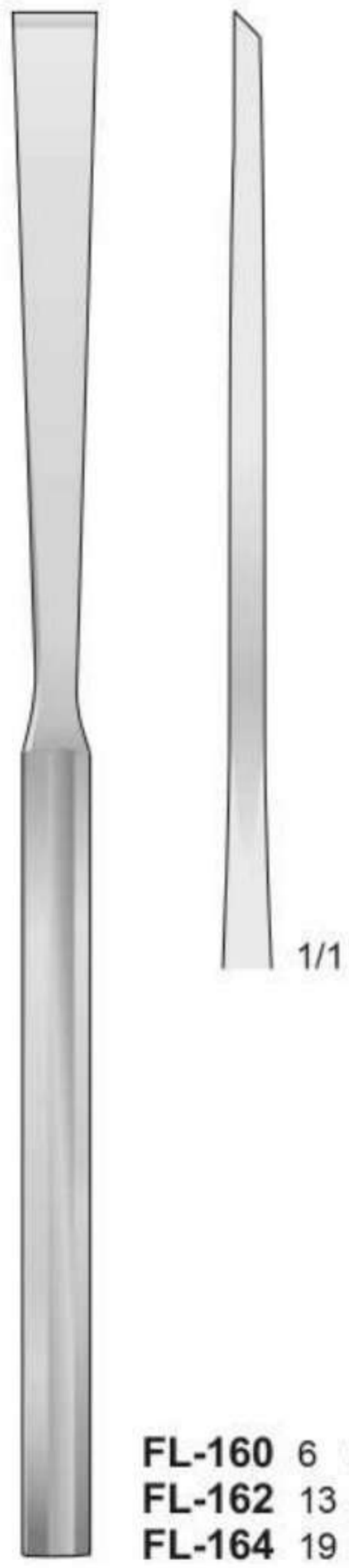

HIBBS
FL-160/FL-164
230 mm

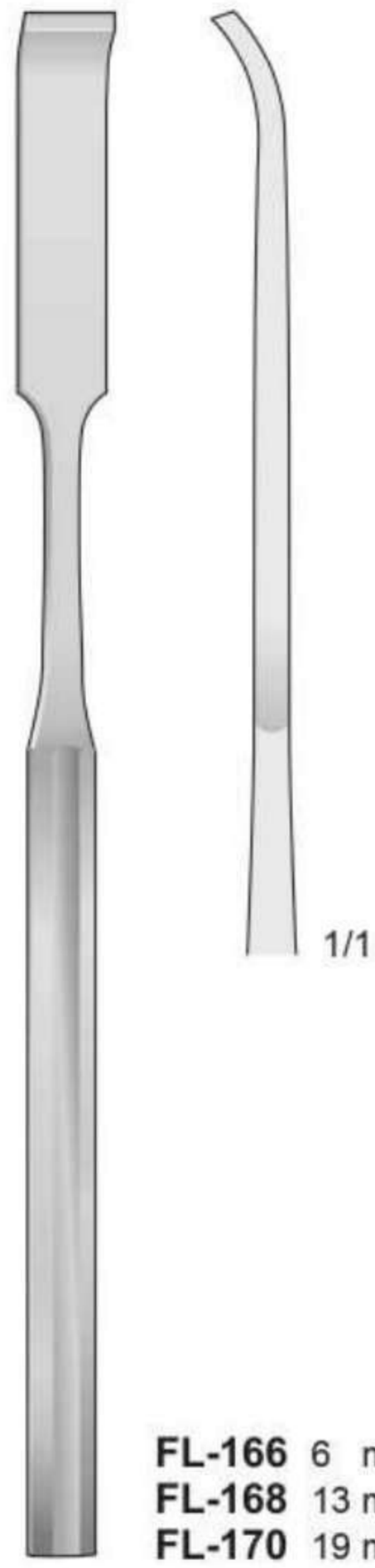

HIBBS
FL-166/FL-170
230 mm

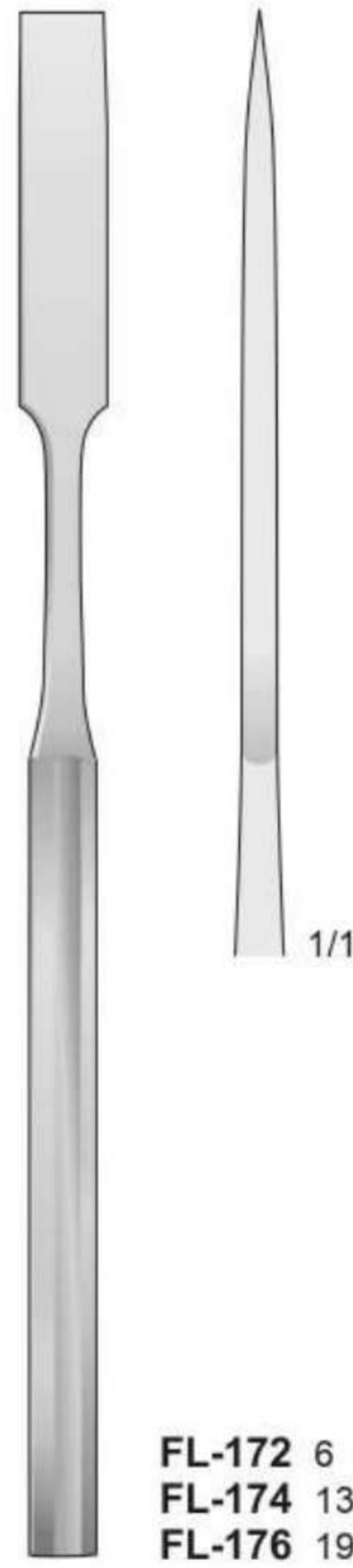

HIBBS
FL-172/FL-176
230 mm

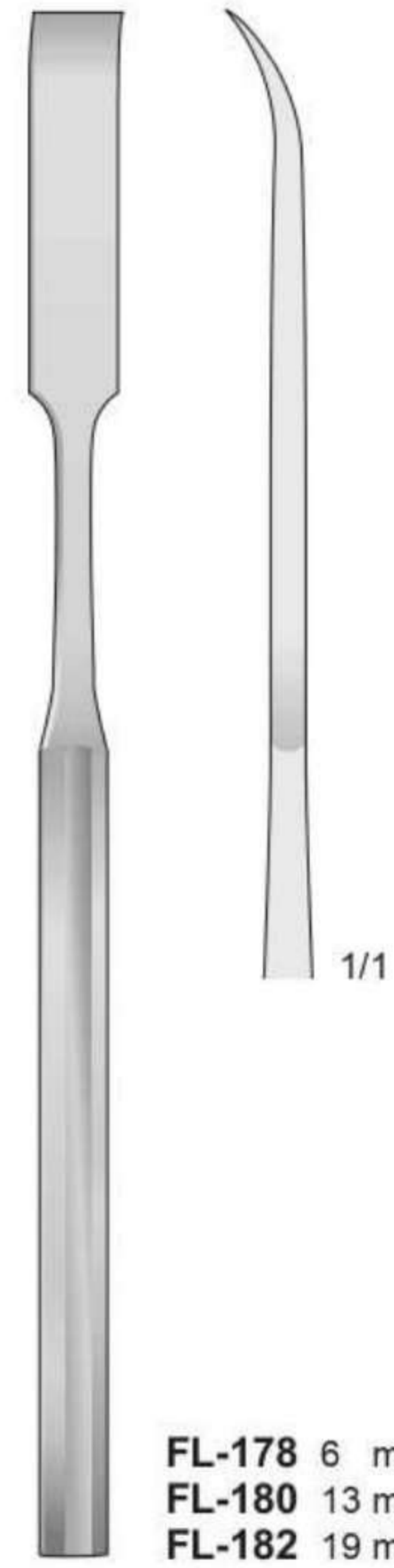

HIBBS
FL-178/FL-182
230 mm

Osteotome

Osteotomes

Osteotomi

Osteótomos

Ostéotomes



DO-190 4 mm
DO-191 6 mm
DO-192 8 mm

DO-190/DO-192
180 mm

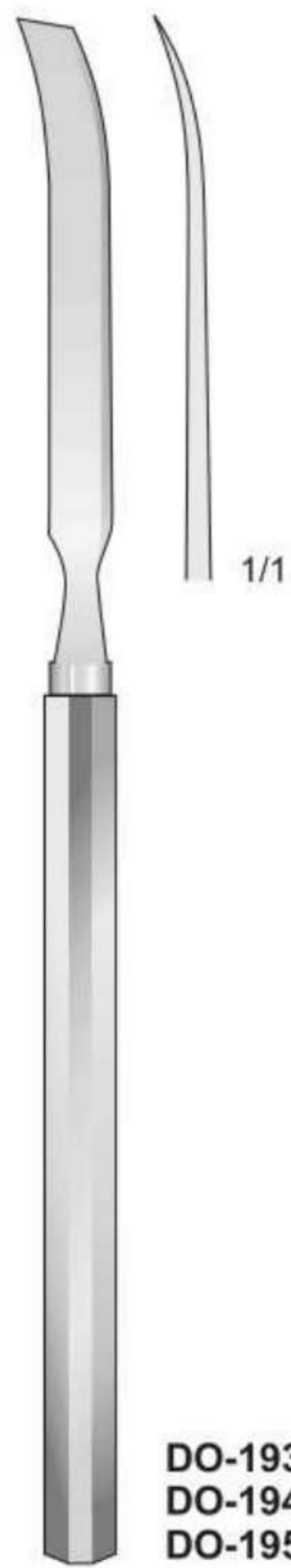

DO-193 4 mm
DO-194 6 mm
DO-195 8 mm

DO-193/DO-195
180 mm

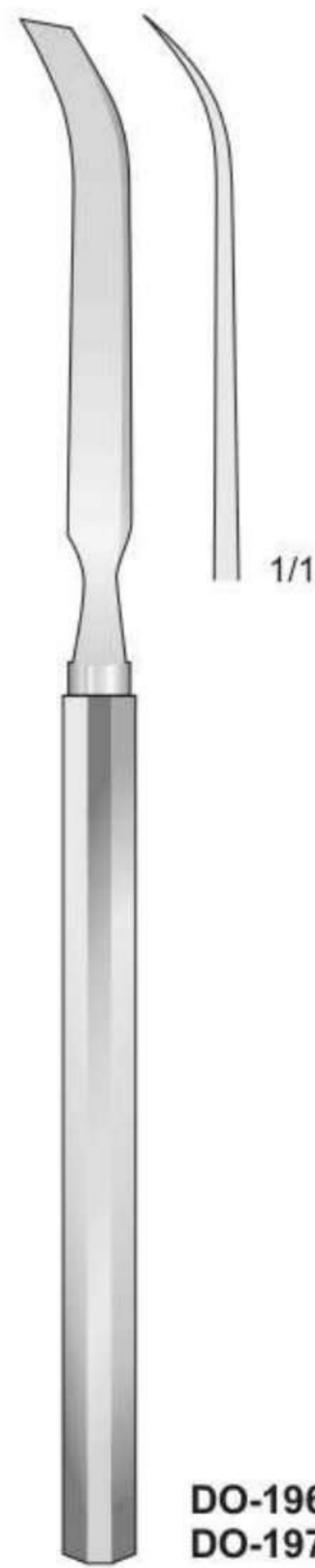

DO-196 6 mm
DO-197 8 mm

DO-196/DO-197
180 mm

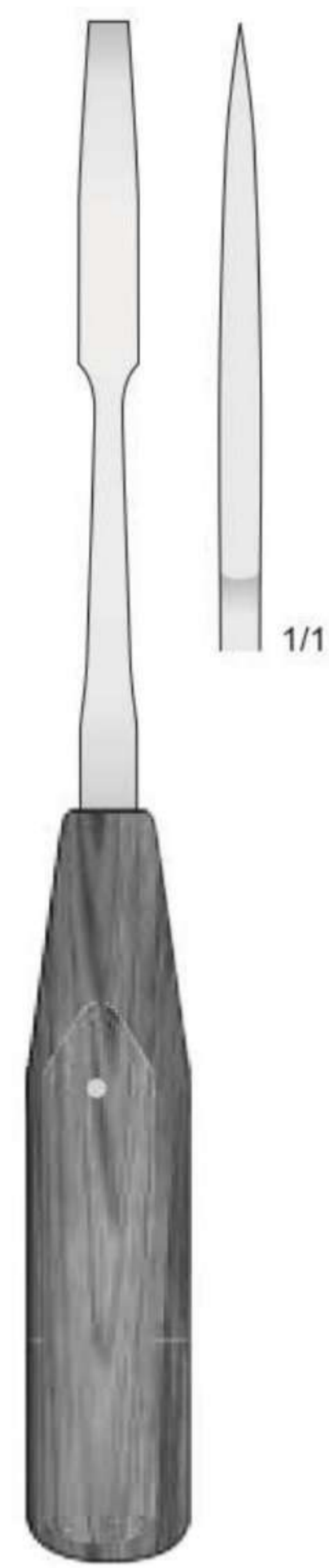

MINI-LEXER
FL-59/FL-62
200 mm

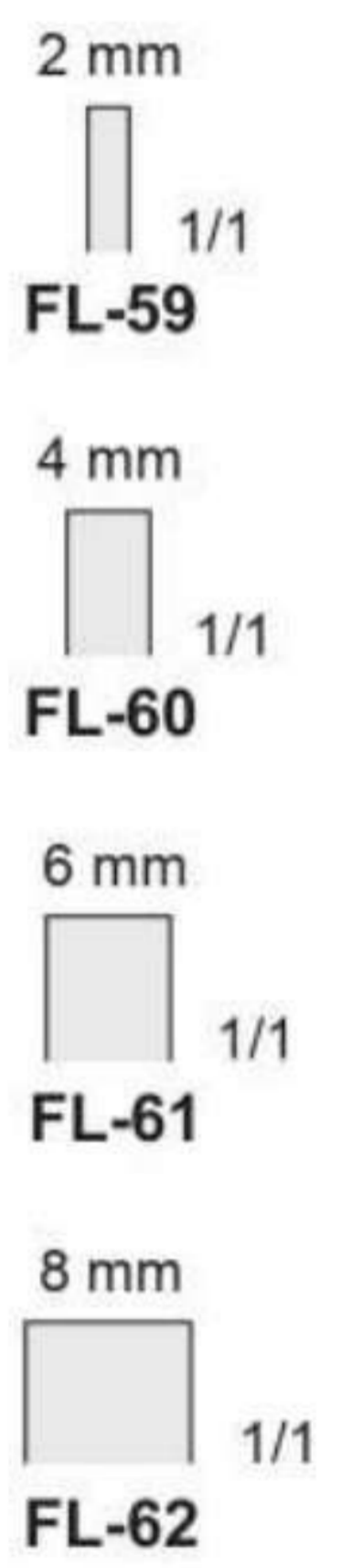

Osteotome
Meißeln

Osteotomes
Chisels

Osteotomi
Scalpelli

Osteótomos
Cinceles

Ostéotomes
Burins

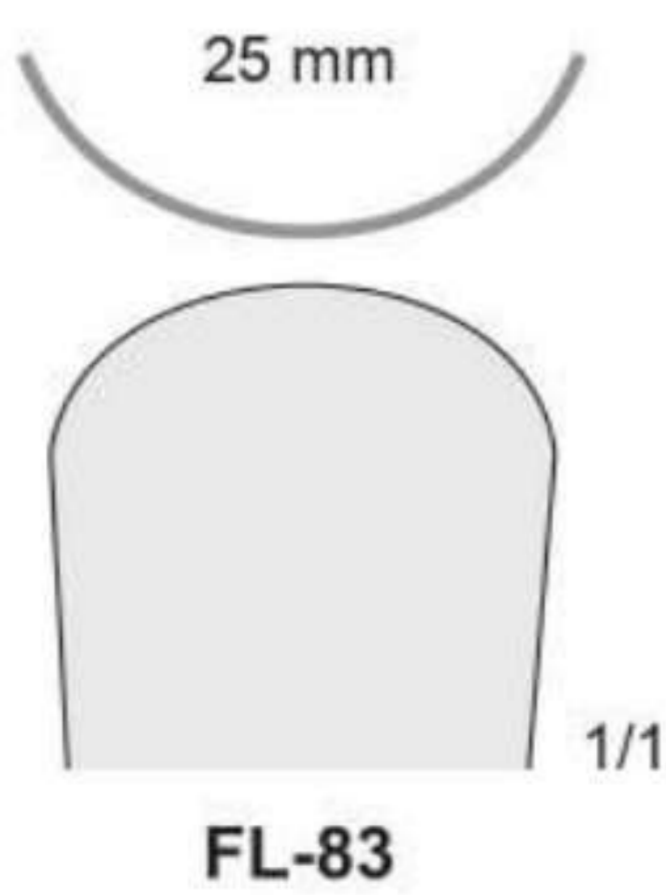
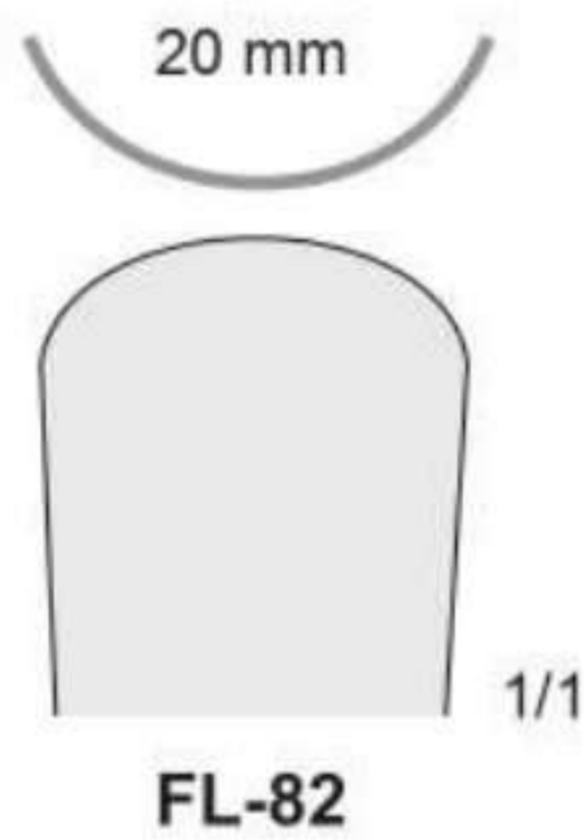

STILLE
FL-63/FL-83
200 mm

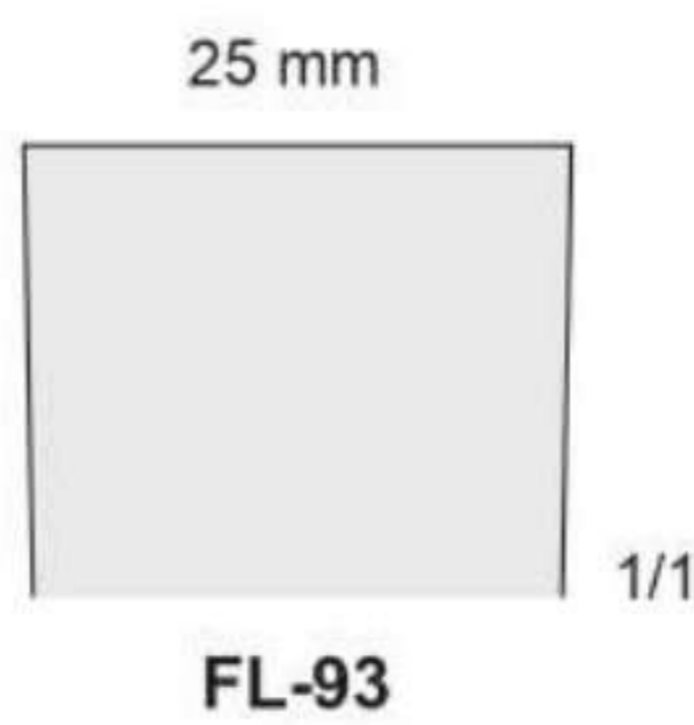
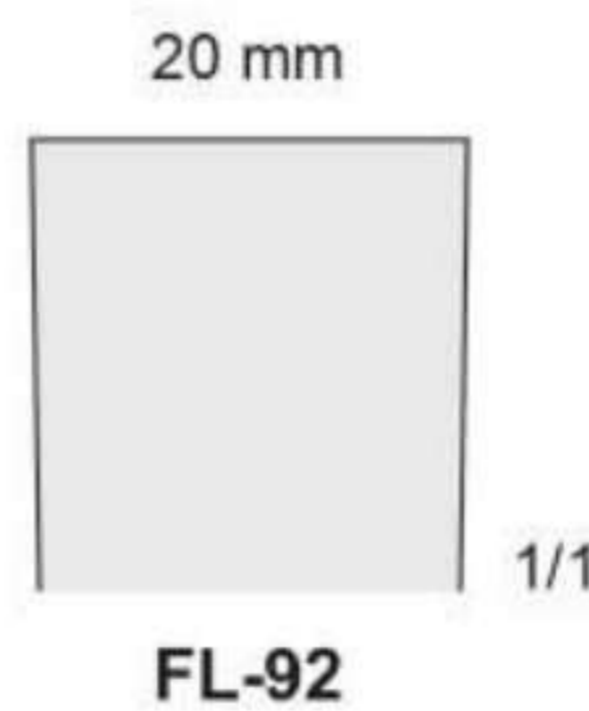
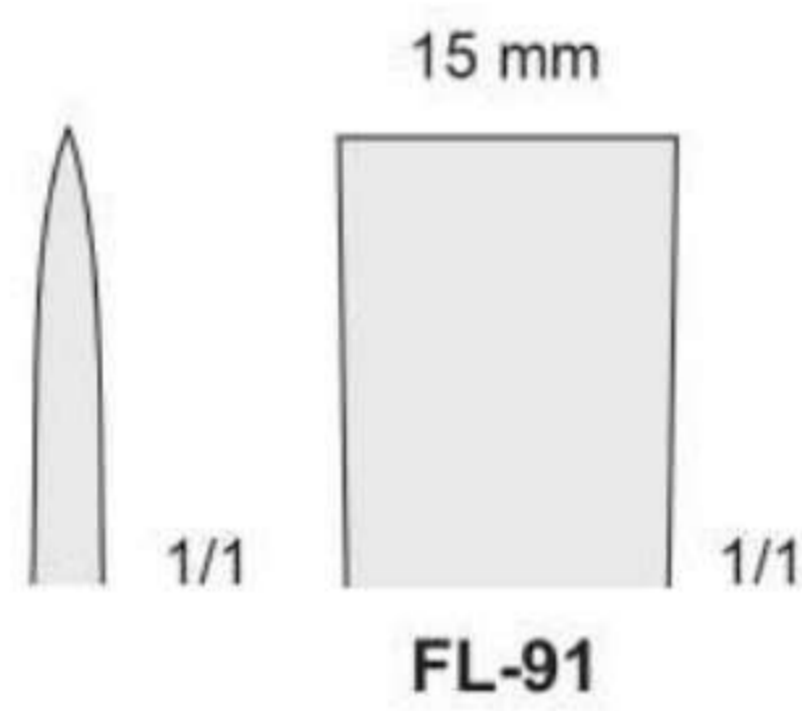
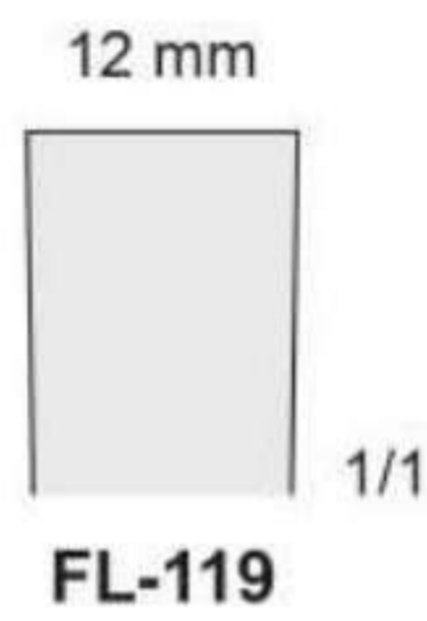
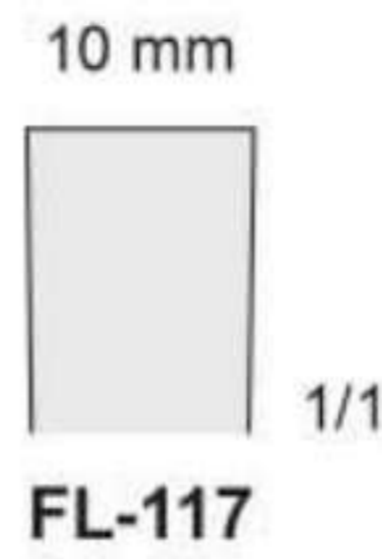

STILLE
FL-91/FL-119
200 mm

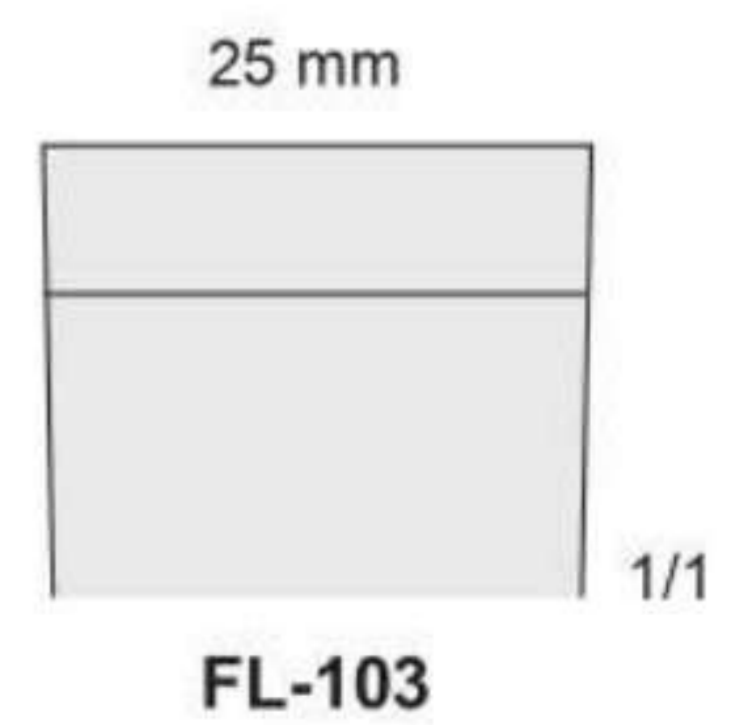
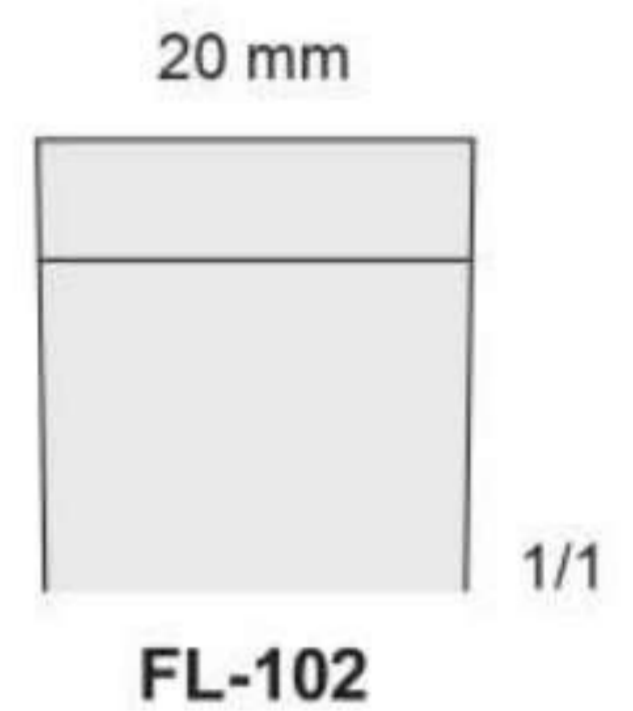
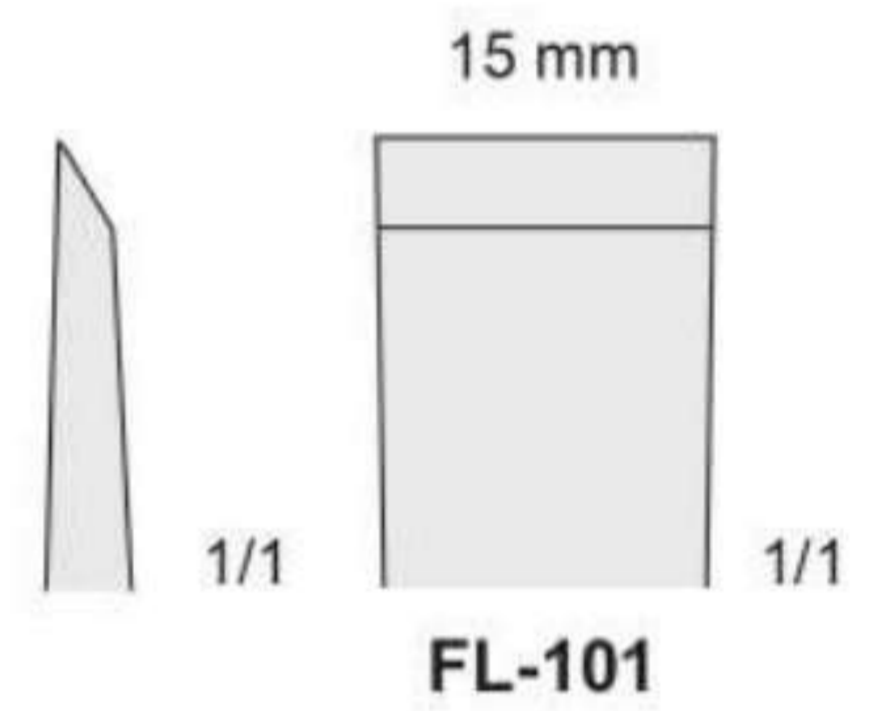
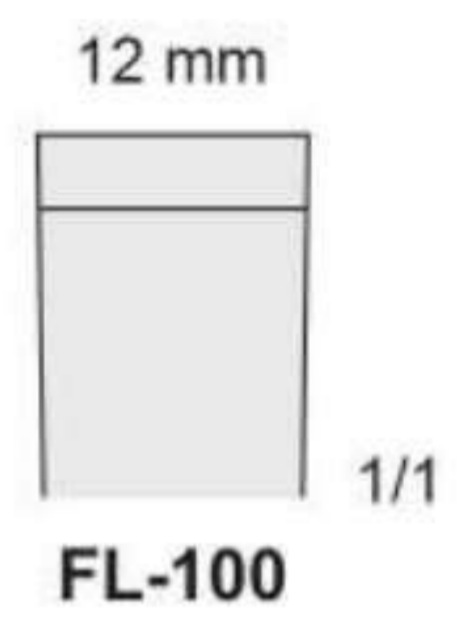
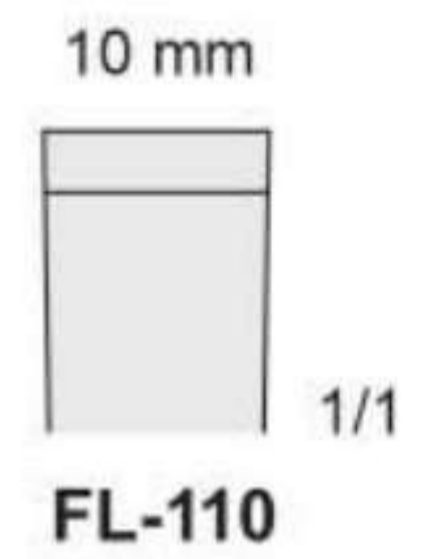

STILLE
FL-100/FL-110
200 mm

Osteotome

Osteotomes

Osteotomi

Osteótomos

Ostéotomes

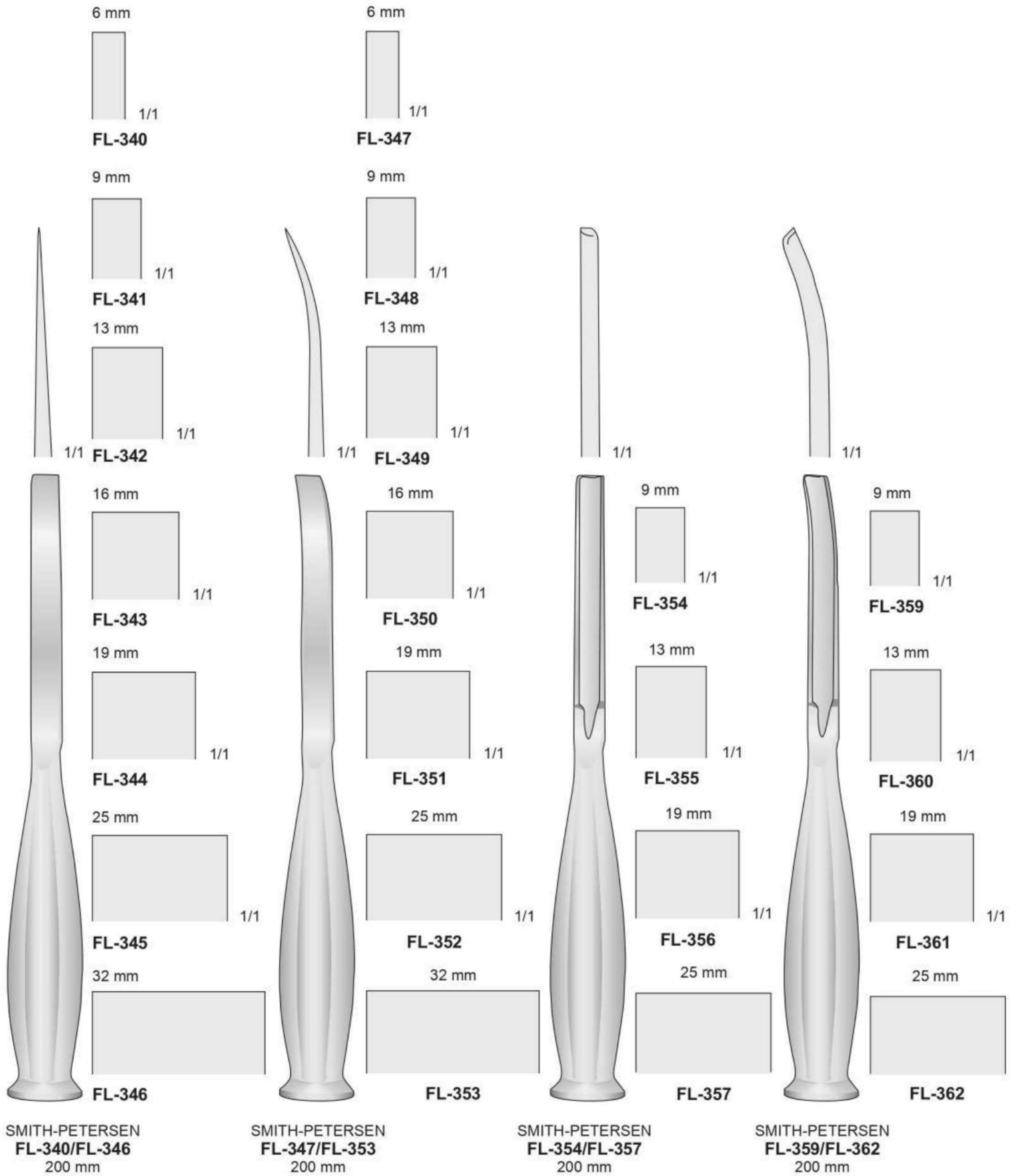

Osteotome

Osteotomes

Osteotomi

Osteótomos

Ostéotomes



FL-307 10 mm
FL-308 15 mm
FL-309 20 mm
FL-310 30 mm

TESSIER
FL-307/FL-310
200 mm

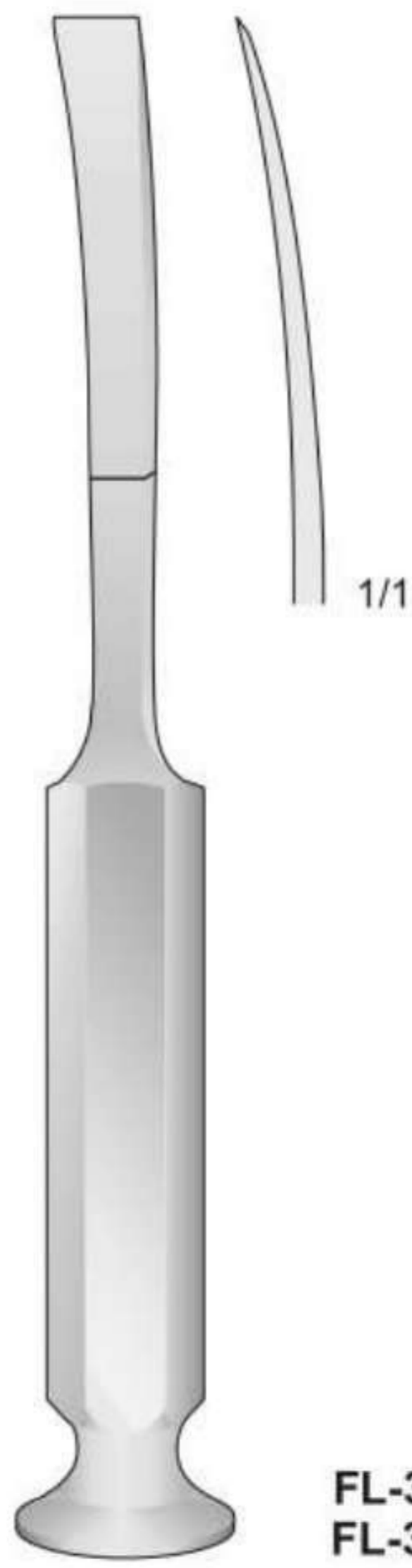

FL-311 10 mm
FL-312 15 mm

TESSIER
FL-311/FL-312
200 mm

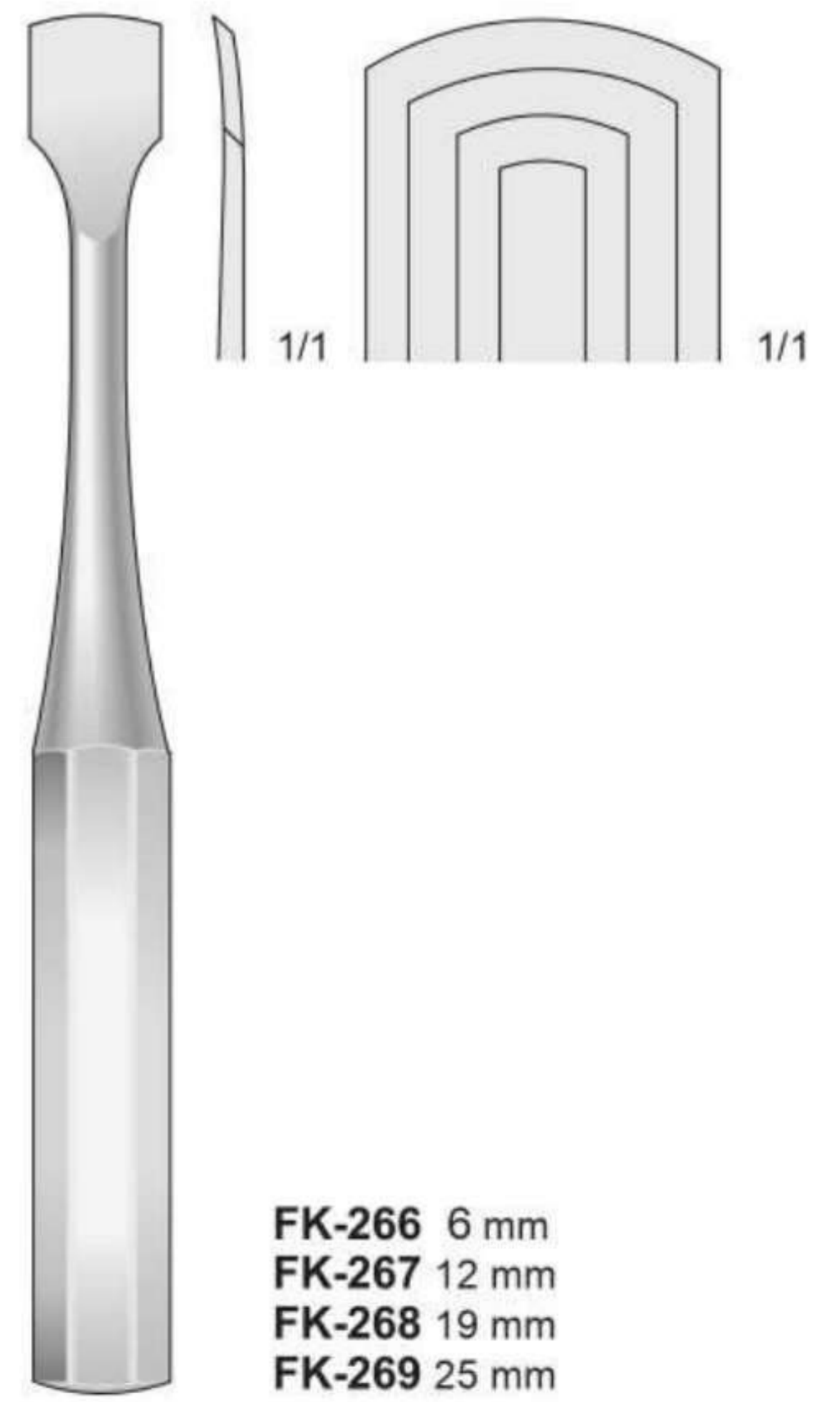

FK-266 6 mm
FK-267 12 mm
FK-268 19 mm
FK-269 25 mm

KEY
FK-266/FK-269
190 mm

Osteotome

Osteotomes

Osteotomi

Osteótomos

Ostéotomes



- FL-230 4 mm
- FL-231 6 mm
- FL-232 8 mm
- FL-233 10 mm
- FL-234 12 mm

MINI-LEXER
FL-230/FL-234
180 mm



- FL-240 4 mm
- FL-241 6 mm
- FL-242 8 mm
- FL-243 10 mm
- FL-244 12 mm

MINI-LEXER
FL-240/FL-244
180 mm



- FL-190 4 mm
- FL-191 6 mm
- FL-192 8 mm
- FL-193 10 mm
- FL-194 12 mm

LEXER
FL-190/FL-194
180 mm

Osteotome

Osteotomes

Osteotomi

Osteótomos

Ostéotomes



- FL-210 5 mm
- FL-211 7 mm
- FL-212 10 mm
- FL-213 15 mm
- FL-214 20 mm
- FL-215 25 mm
- FL-216 30 mm

LEXER
FL-210/FL-216
220 mm



- FL-220 5 mm
- FL-221 7 mm
- FL-222 10 mm
- FL-223 15 mm
- FL-224 20 mm
- FL-225 25 mm
- FL-226 30 mm

LEXER
FL-220/FL-226
220 mm



FL-272
220 mm

9 mm

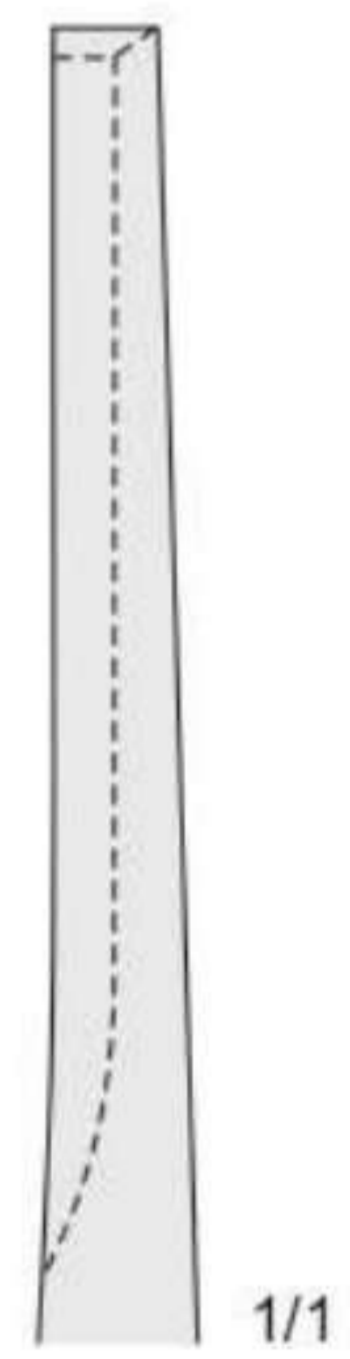

Osteotome

Osteotomes

Osteotomi

Osteótomos

Ostéotomes

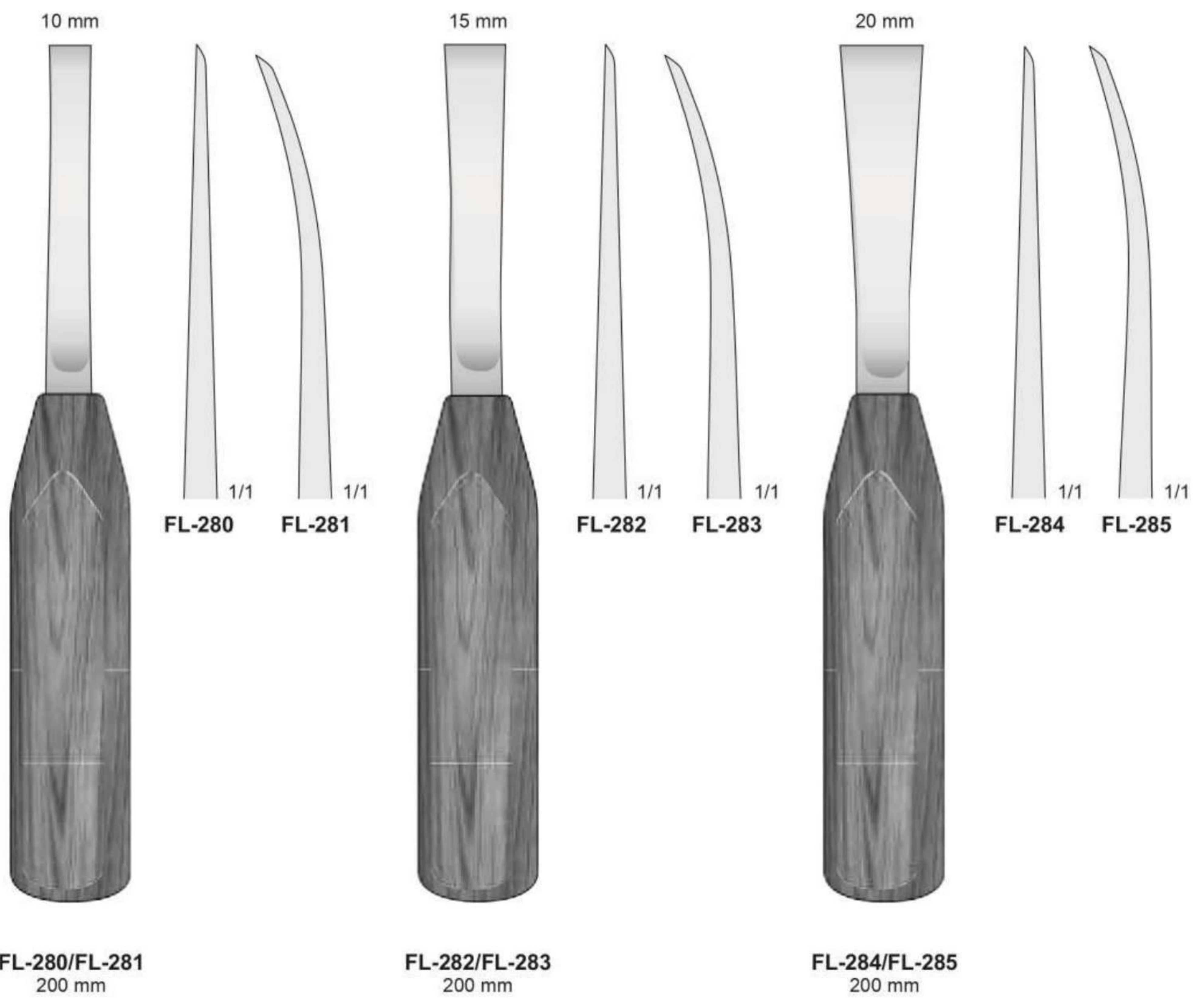

Osteotome

Osteotomes

Osteotomi

Osteótomos

Ostéotomes

Hohlmeissel - Gouges
Sgorbie - Gubias - Gouges

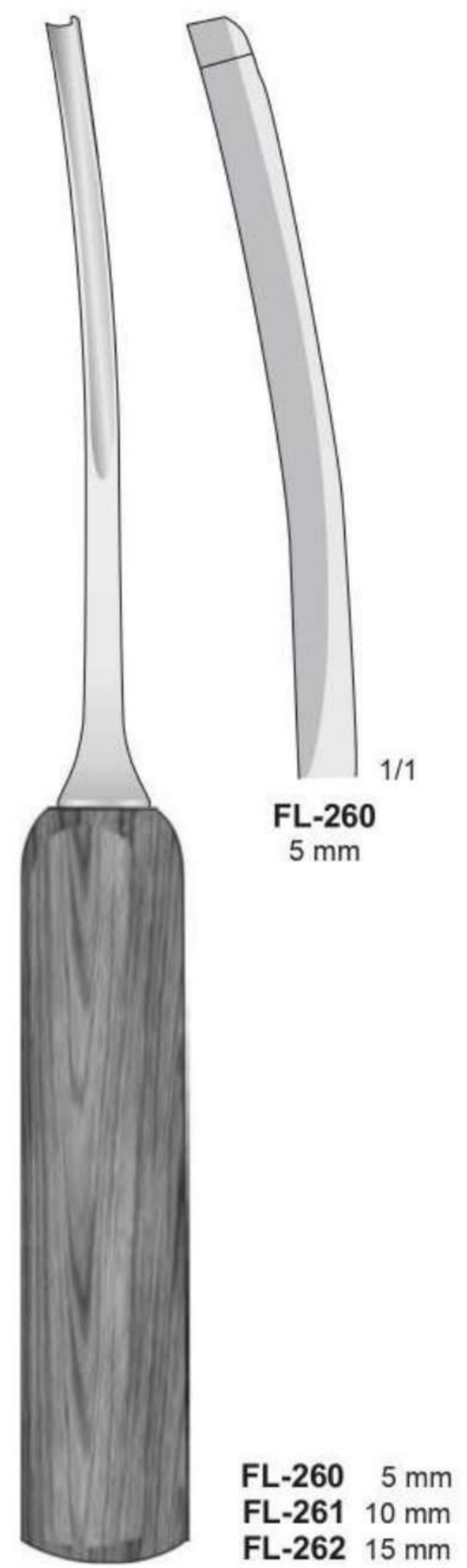
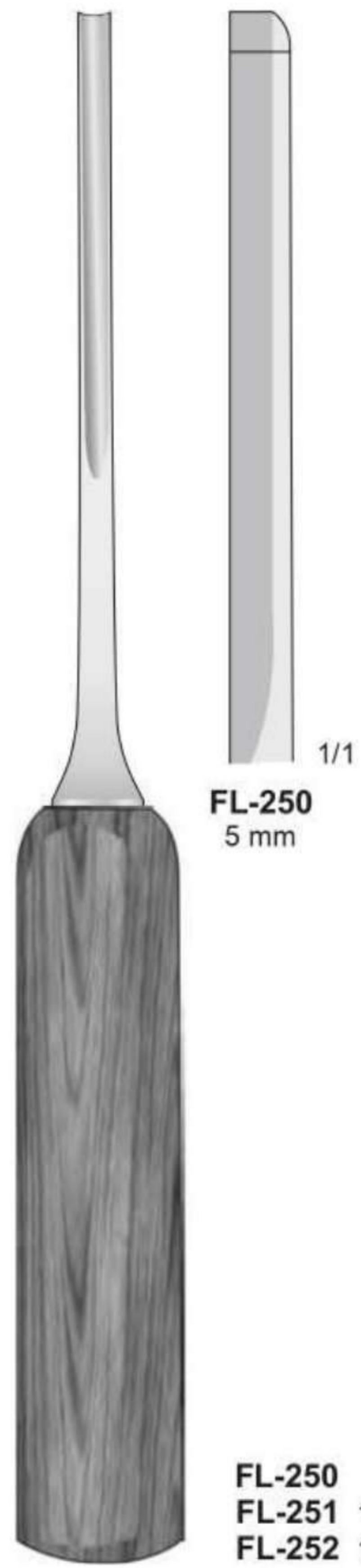
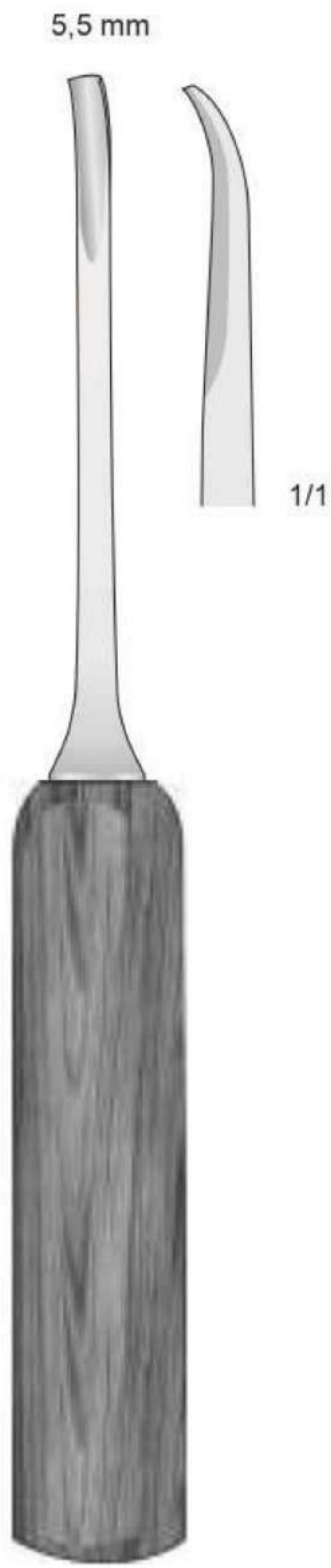

Osteotome

Osteotomes

Osteotomi

Osteótomos

Ostéotomes

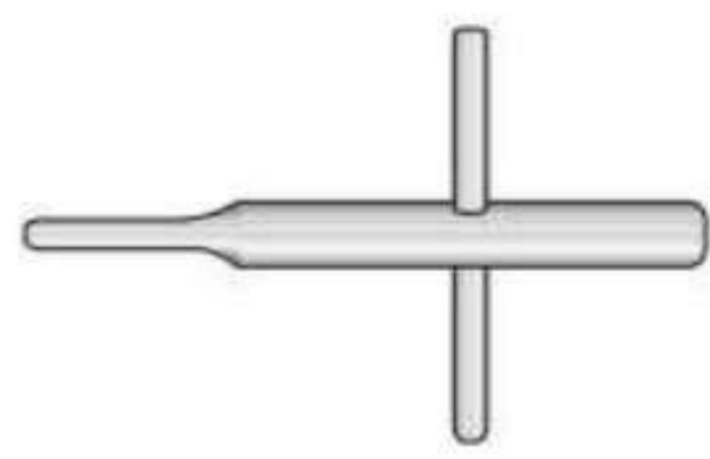

FL-84
90 mm

Fig. 1
5 mm

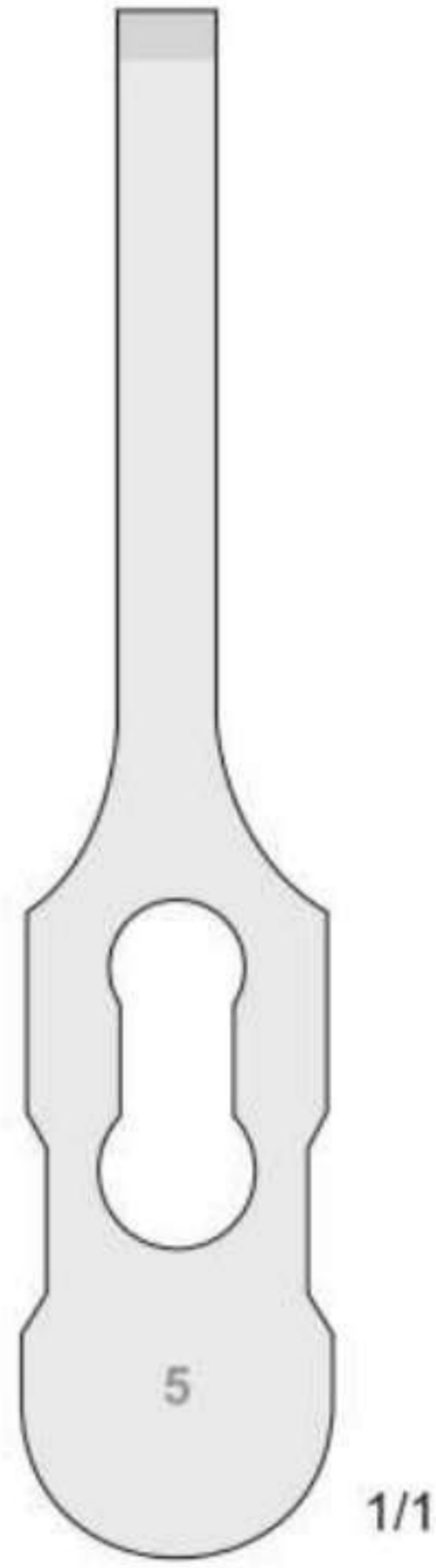

FL-86
85 mm

Fig. 2
10 mm

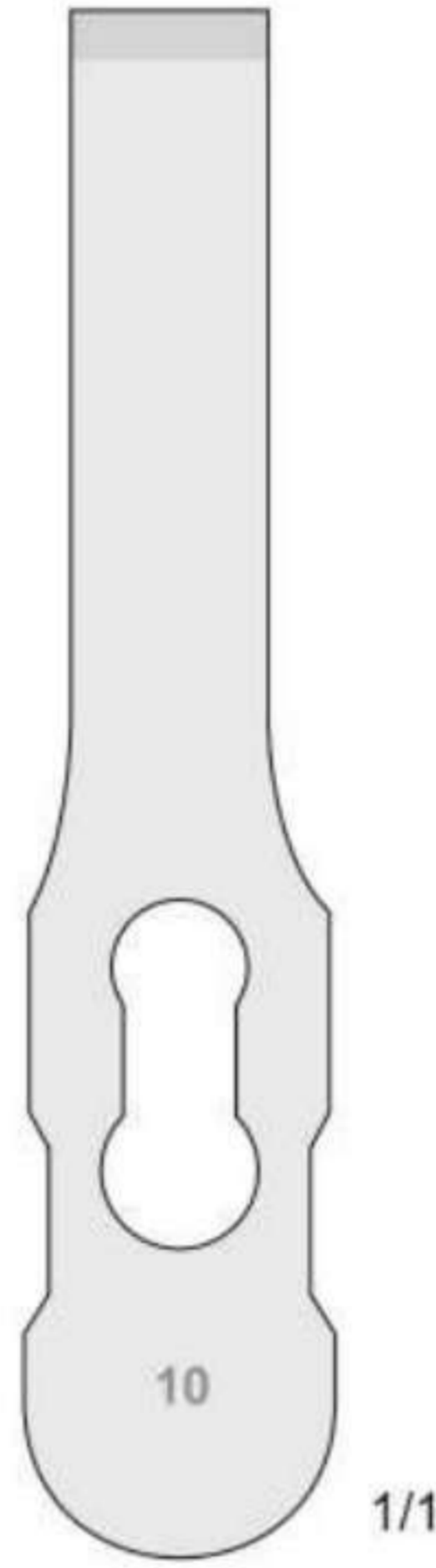

FL-87
85 mm

Fig. 3
16 mm

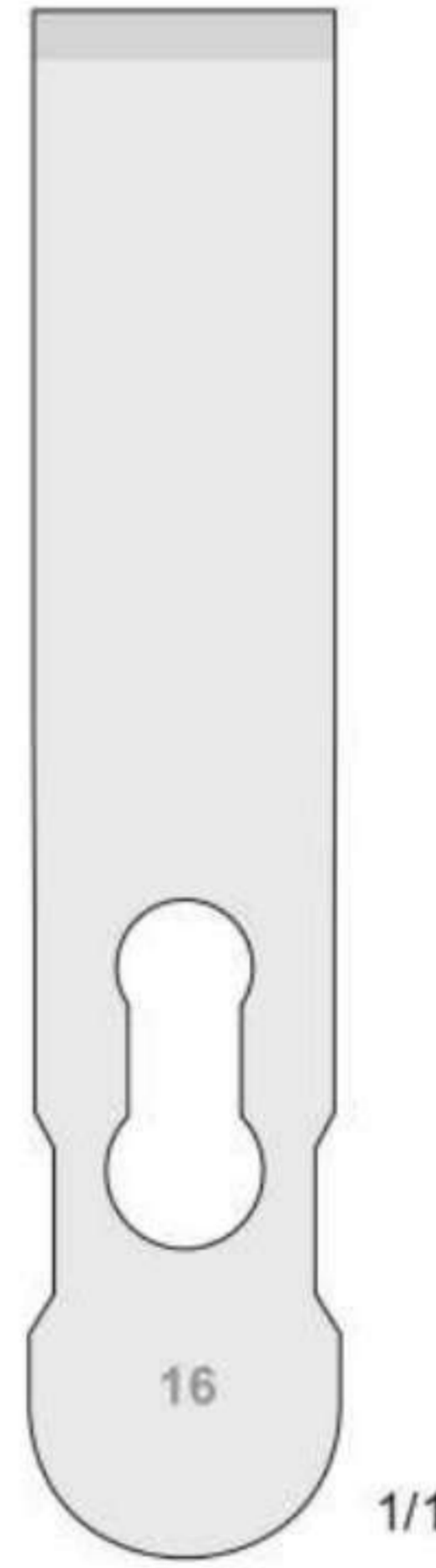

FL-88
85 mm

Fig. 4
25 mm

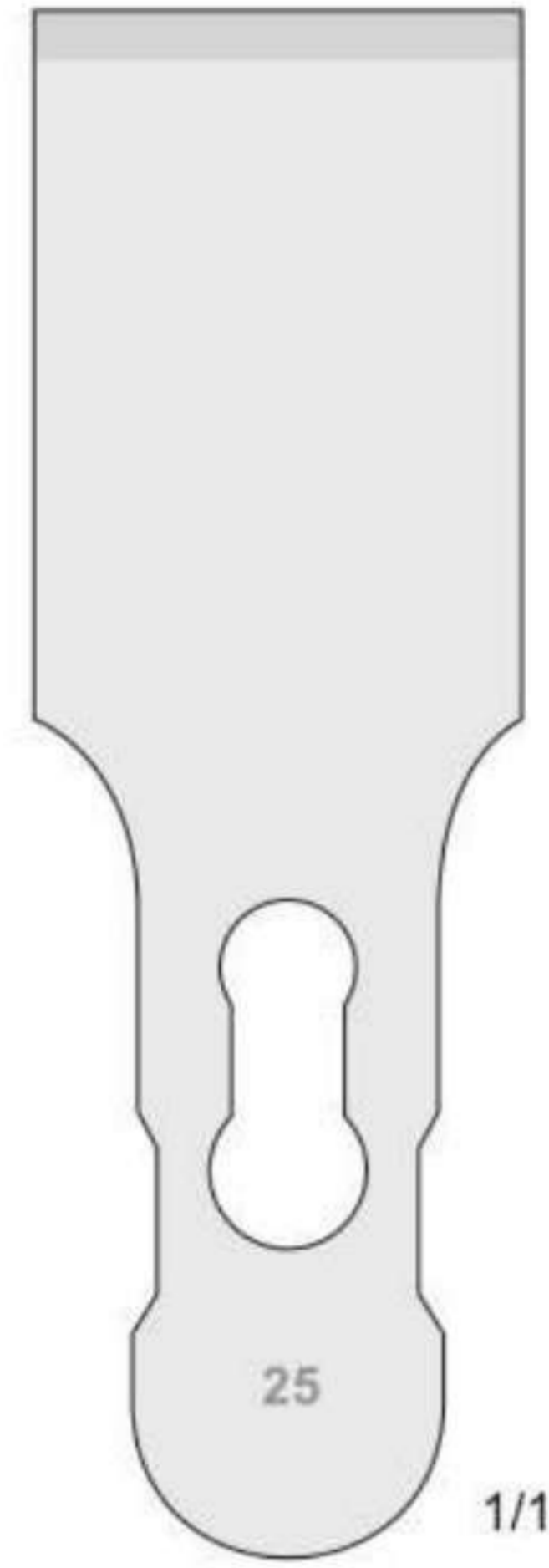

FL-89
85 mm



Meißel
Chisel
Scalpelli
Cinceles
Ciseaux-burins



FL-85
190 mm

Fig. 1
5 mm

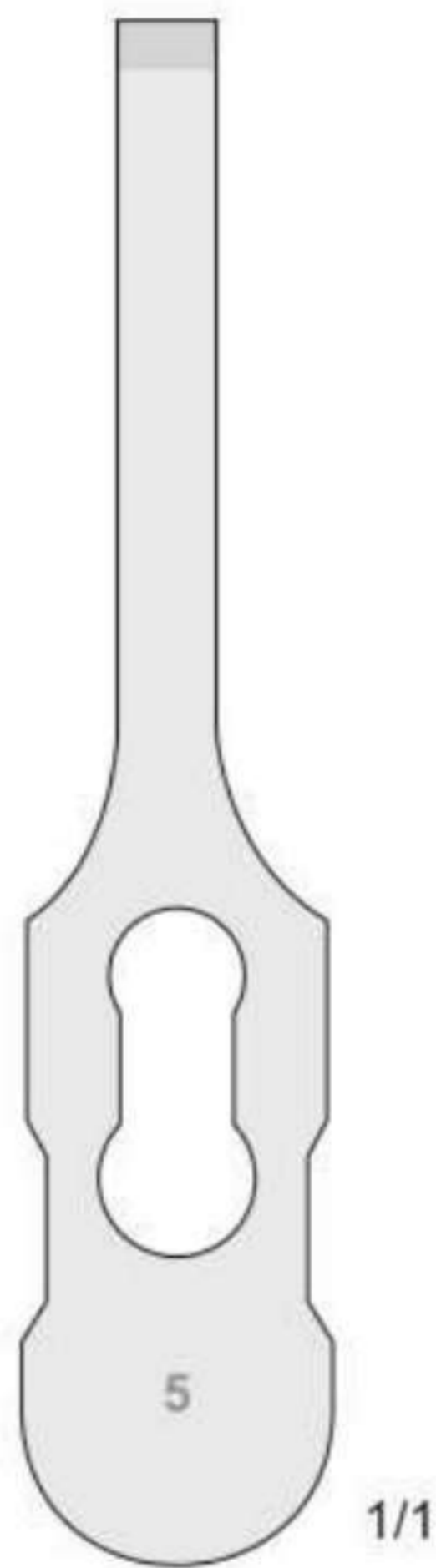

FL-286
85 mm

Fig. 2
10 mm

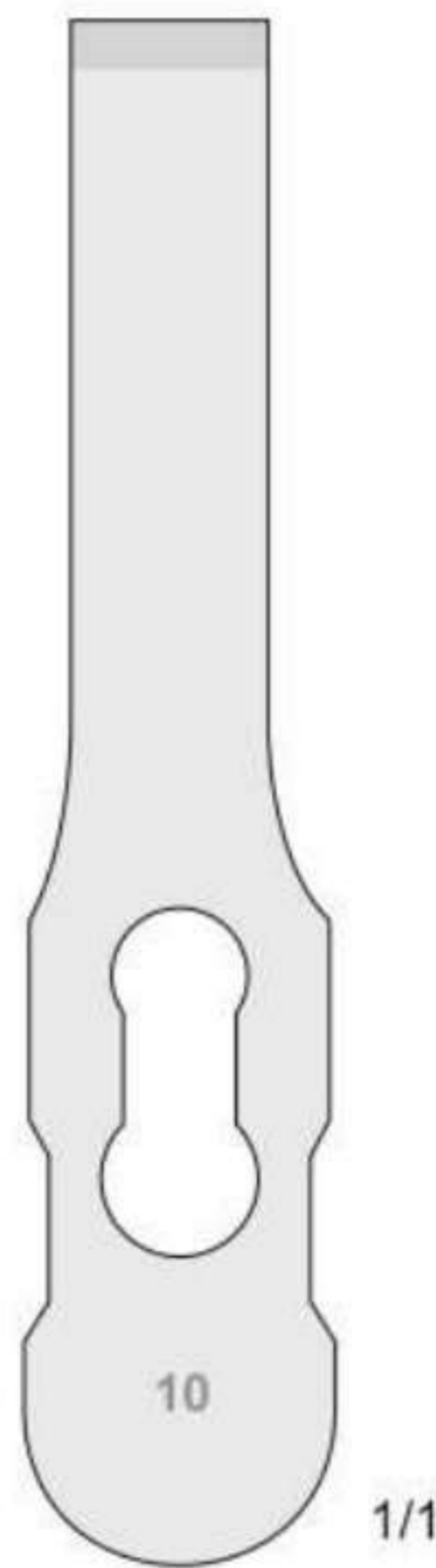

FL-287
85 mm

Fig. 3
16 mm

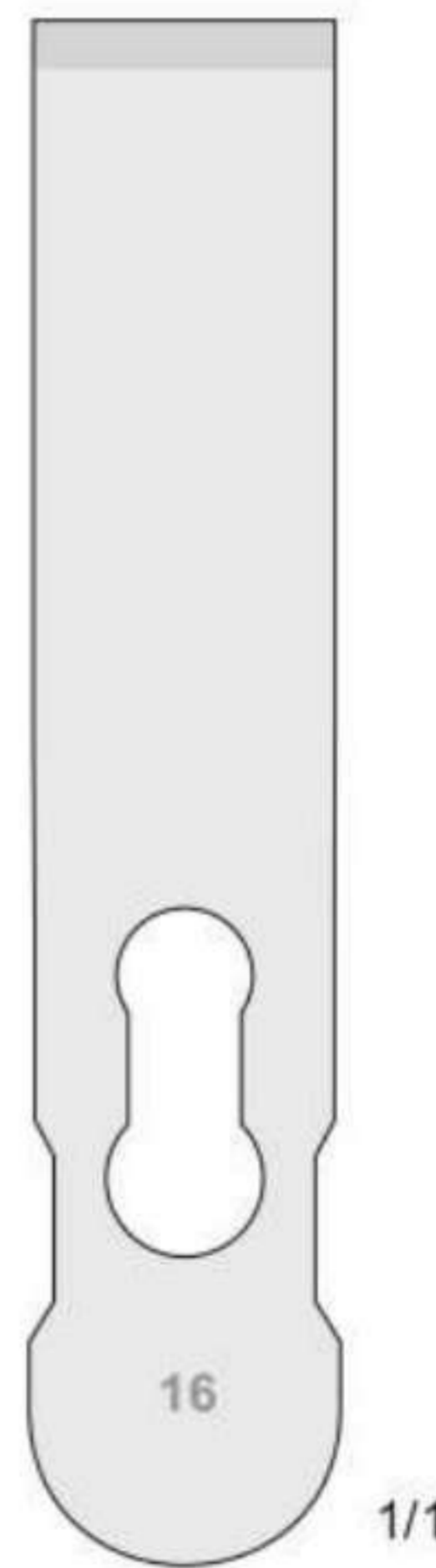

FL-288
85 mm

Fig. 4
25 mm

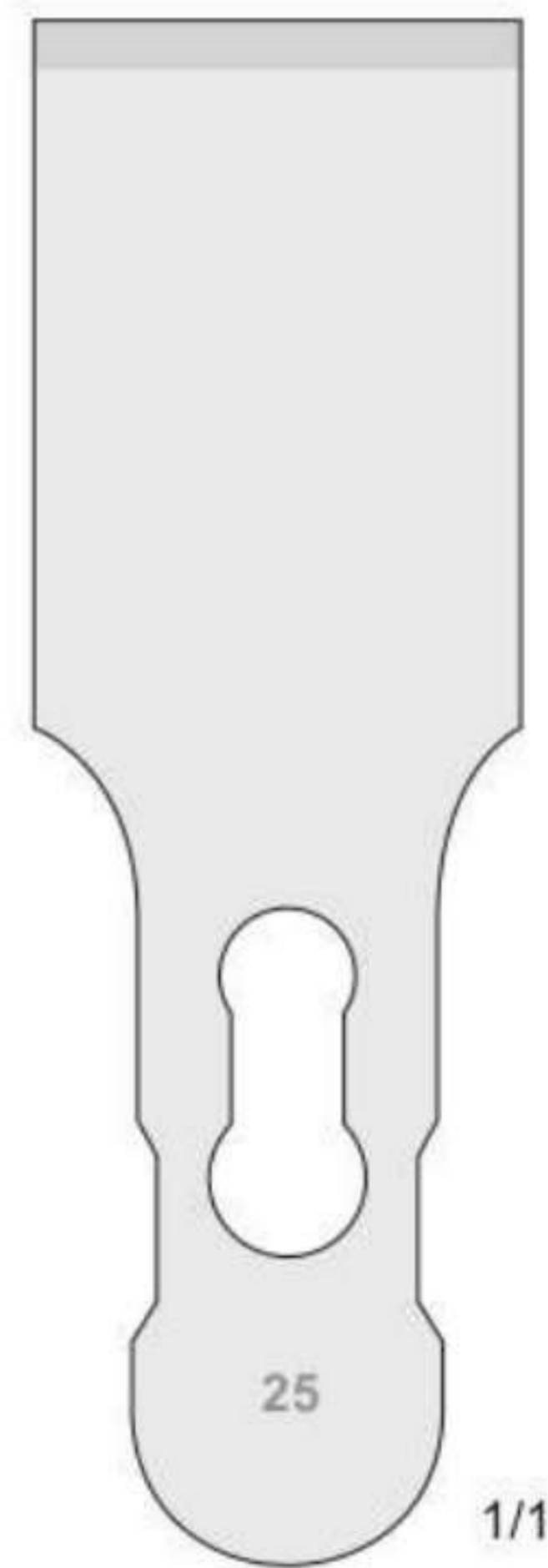

FL-289
85 mm



Osteotom
Gouge
Osteotomi
Cubias
Gouges



TRS INSTRUMENTS

TRAUMATOLOGY AND ORTHOPAEDICS

Bone surgery

Knochenchirurgie
Chirurgie osseuse
Cirugía ósea
Chirurgia ossea

Bone Holding Forceps

Knochenhaltezange
Daviers à os
Pinzas de sujeción para hueso
Pinze per fissare l'osso

Hand Surgery

Handchirurgie
Chirurgie de la main
Cirugía de la mano
Chirurgia della mano

Bone Rongeurs

Hohlmeißelzangen
Pincès gouges
Pinzas gubias
Pinze ossivore

Bone Cutting Scissors

Knochensplitterscheren
Ciseaux à os
Tijeras para huesos
Forbici ossivore

Meniskus und Knorpelfasszangen - Meniscus and cartilage clamp
Pinze per menisco e cartilagine - Pincas à saisir ménisque et cartilages

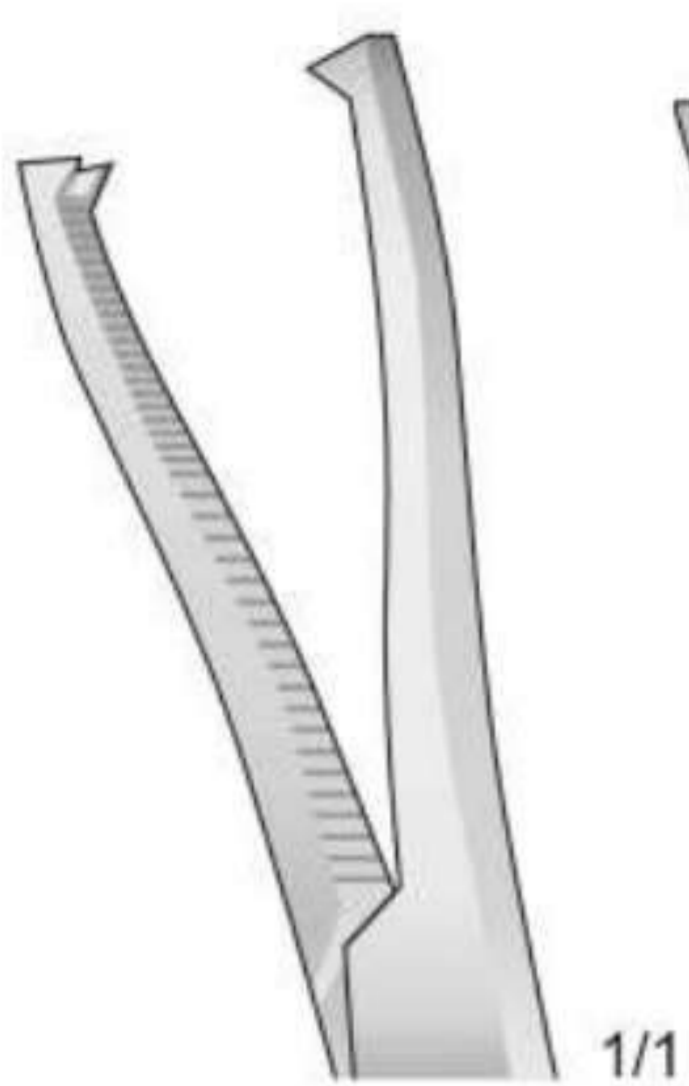

DINGMANN
FO-130

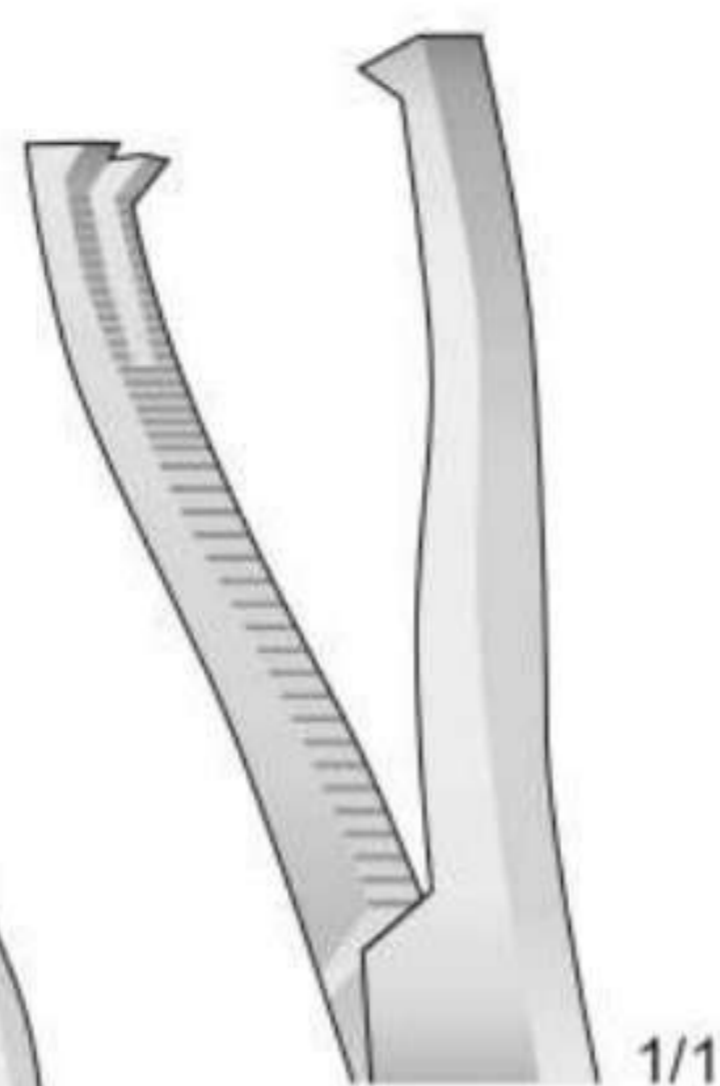

DINGMANN MODIF.
FO-131

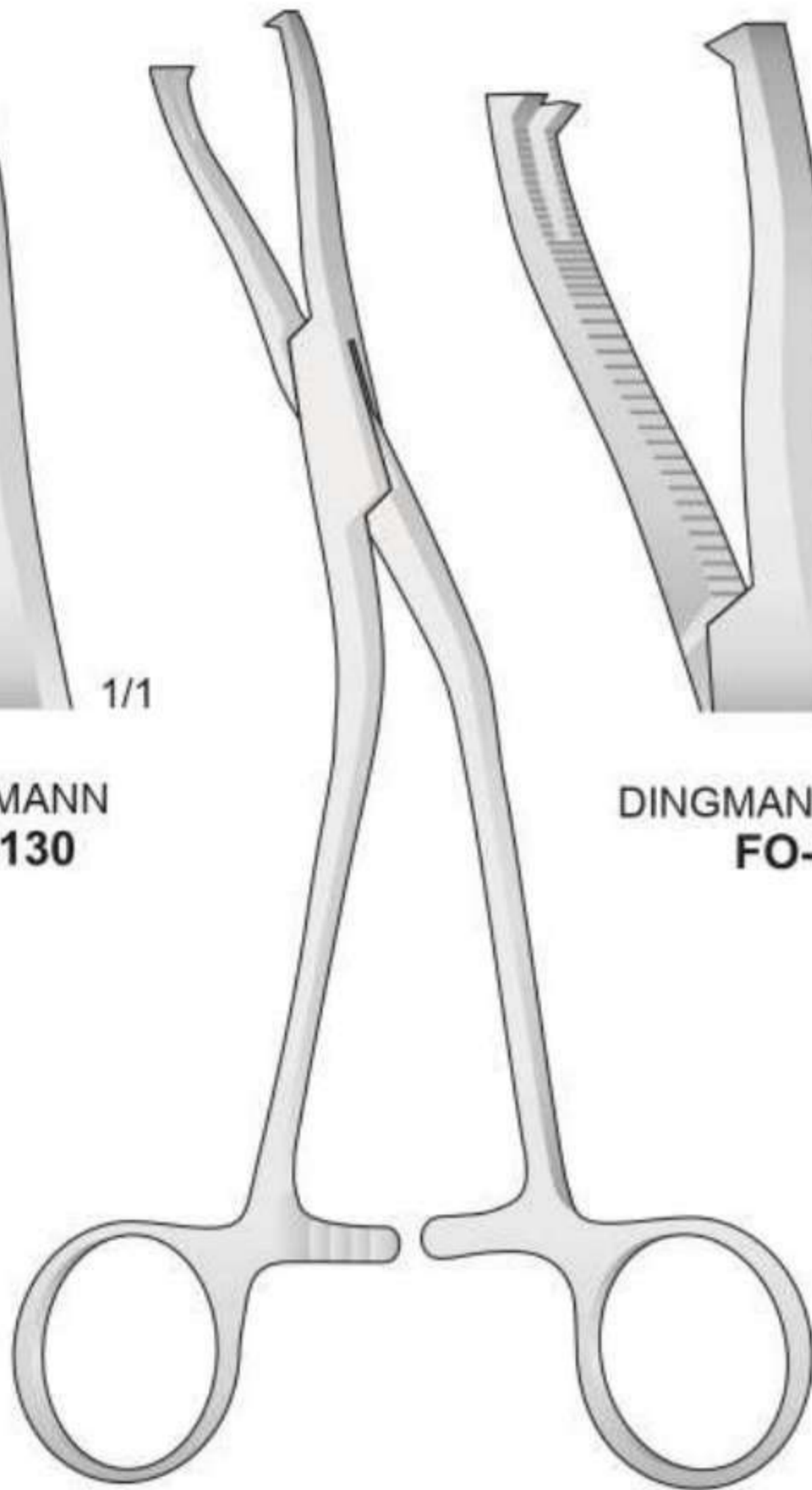

DINGMANN
FO-130/FO-131
190 mm

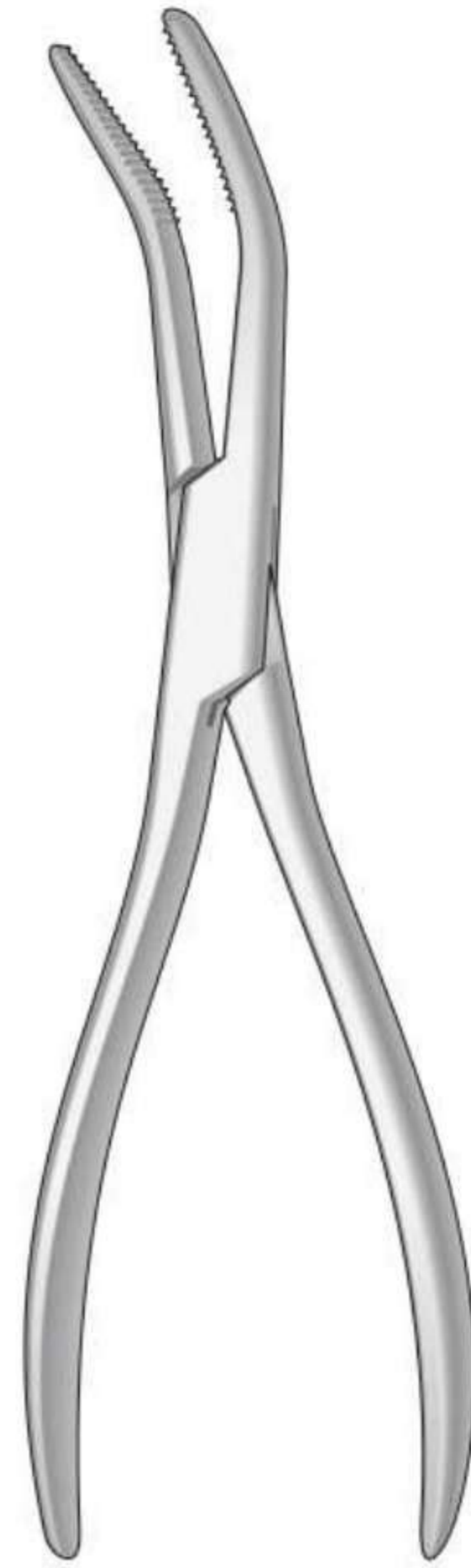

Seitwärts gebogen
Curved to side
Curva su un lato

VAN BUREN
FO-217
225 mm

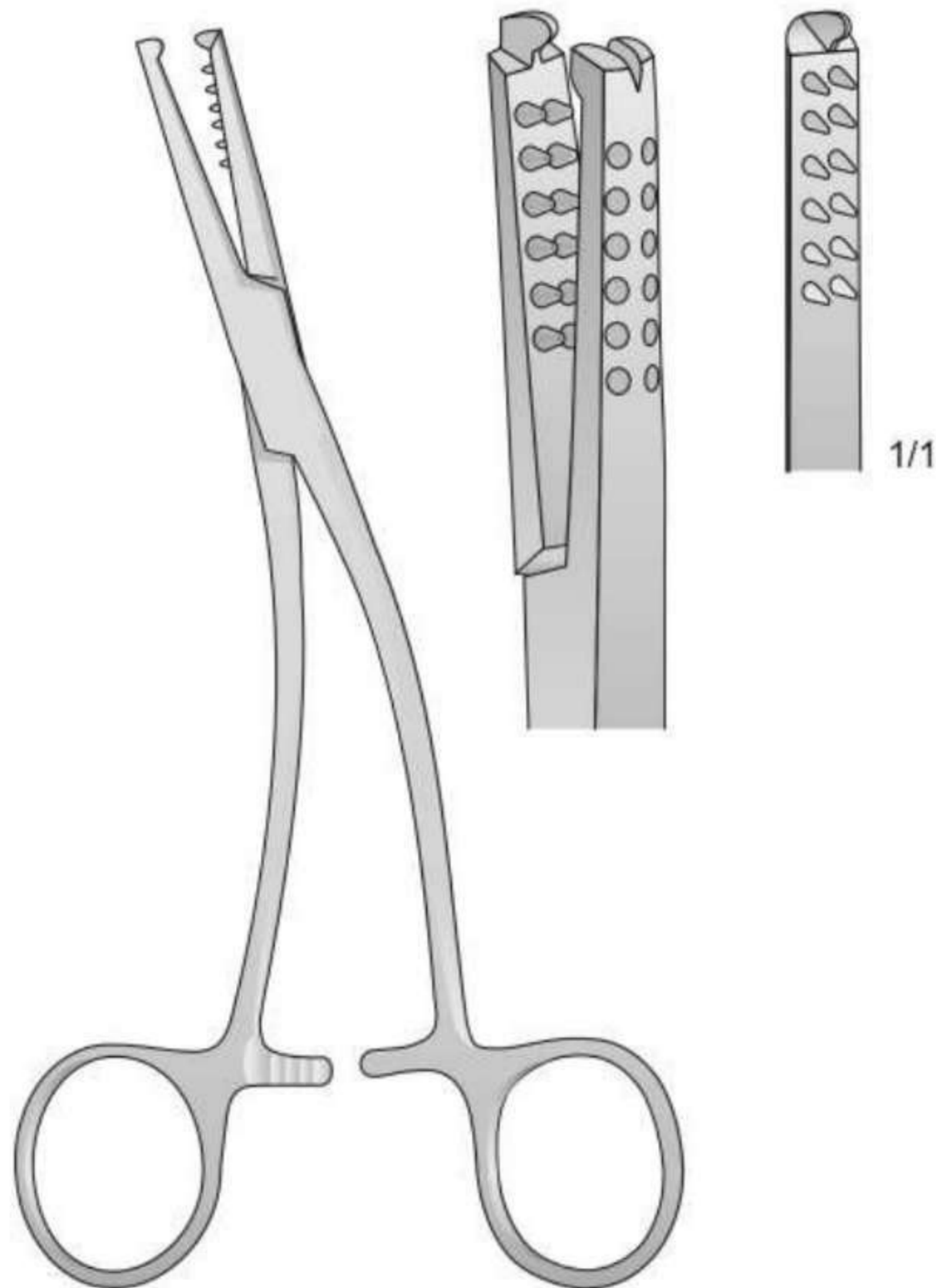

FO-134
185 mm

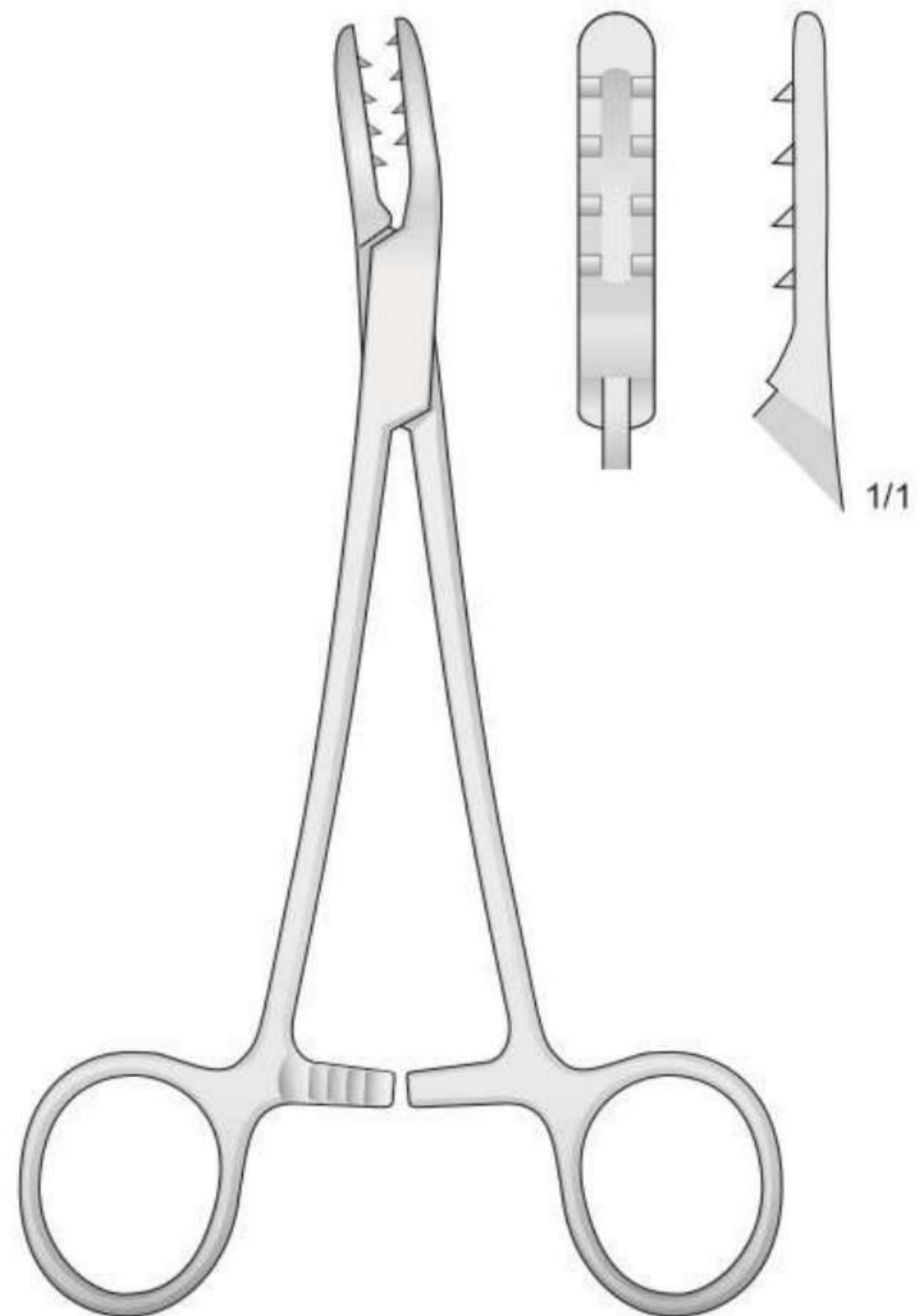

MARTIN
FO-133
200 mm

Repositionszangen - Reposition forceps
Pinze riposizionatrici di osso - Pinzas para la reducción de huesos

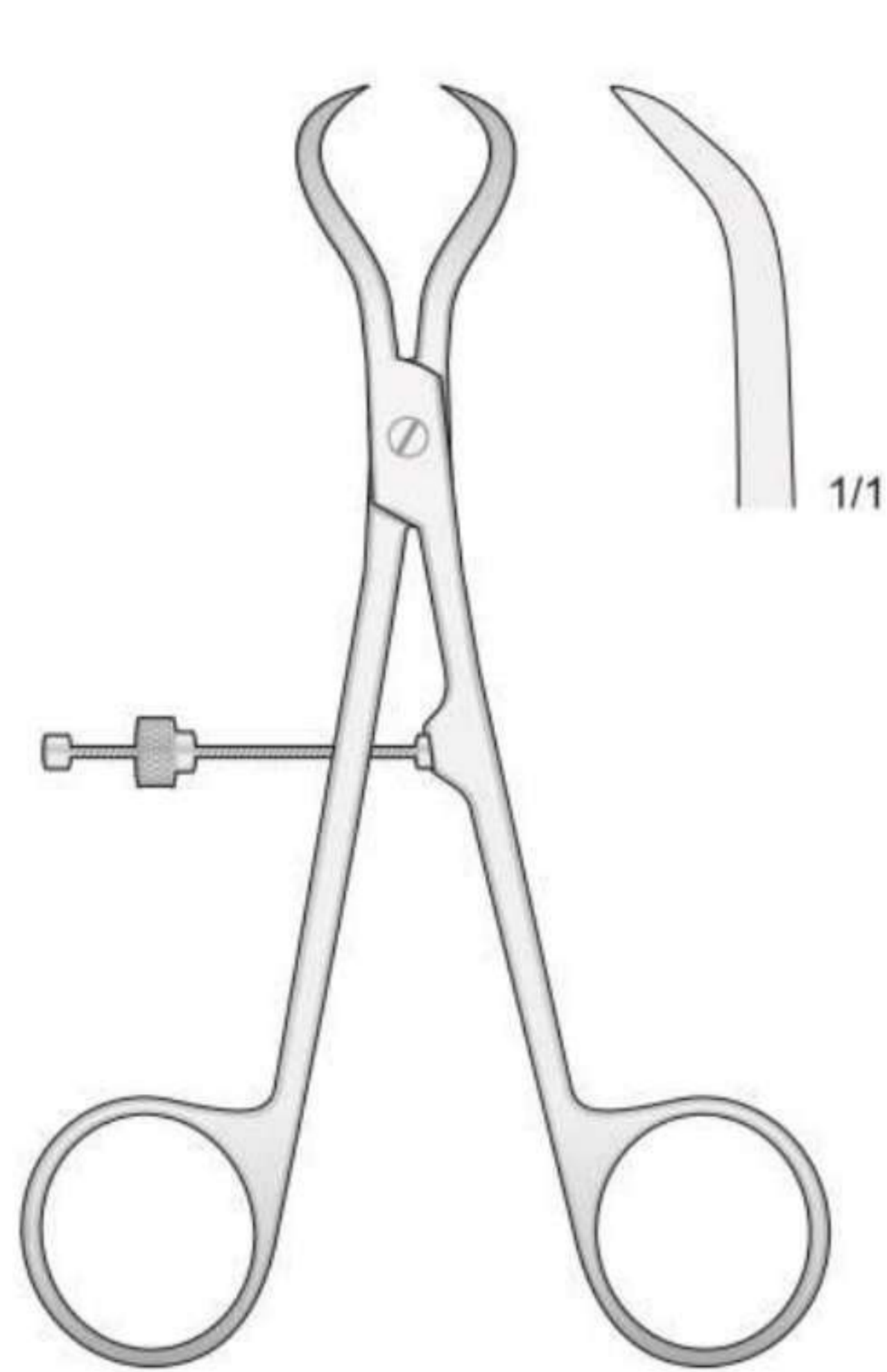

FO-79
140 mm

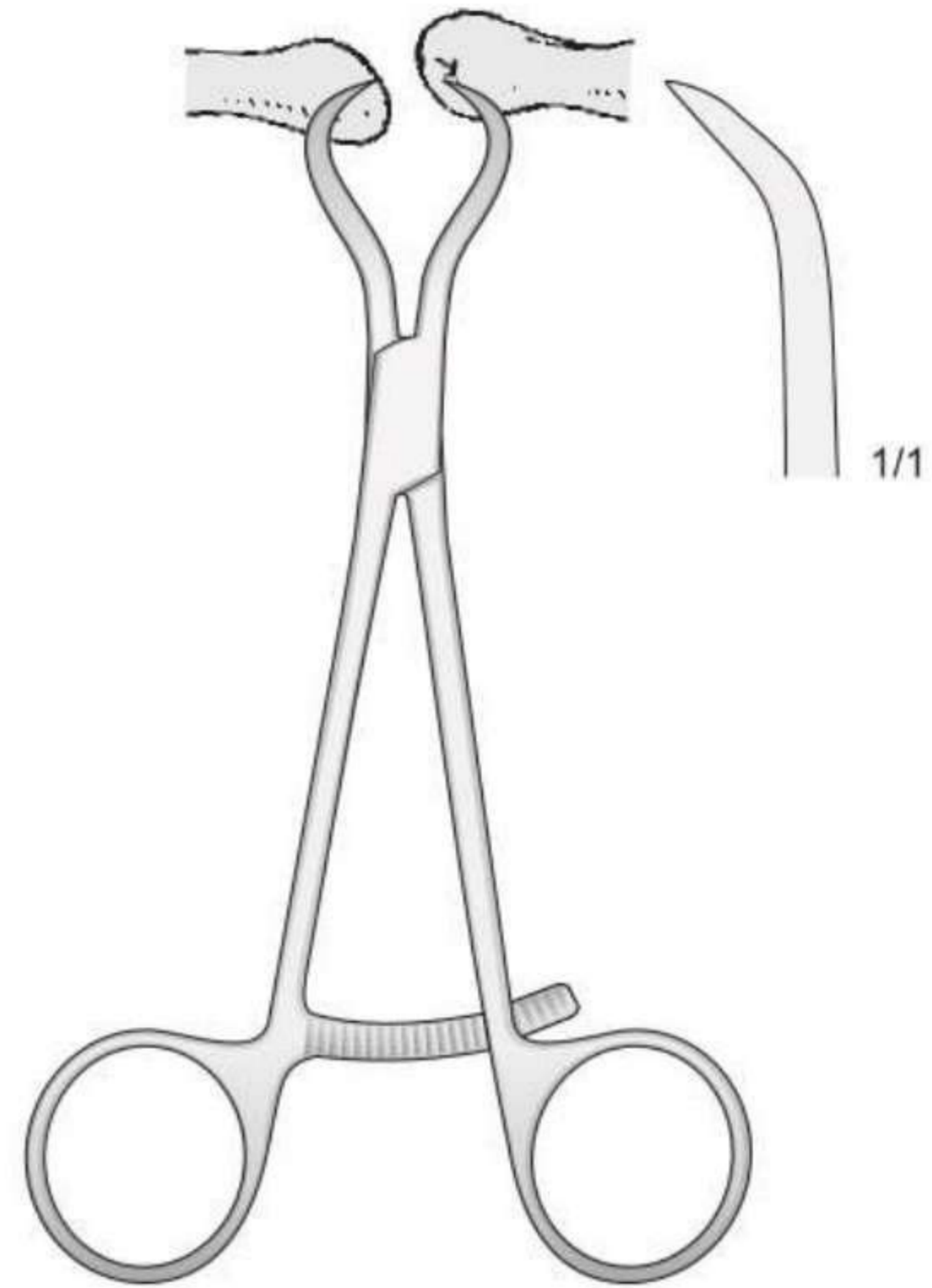

FO-66
135 mm

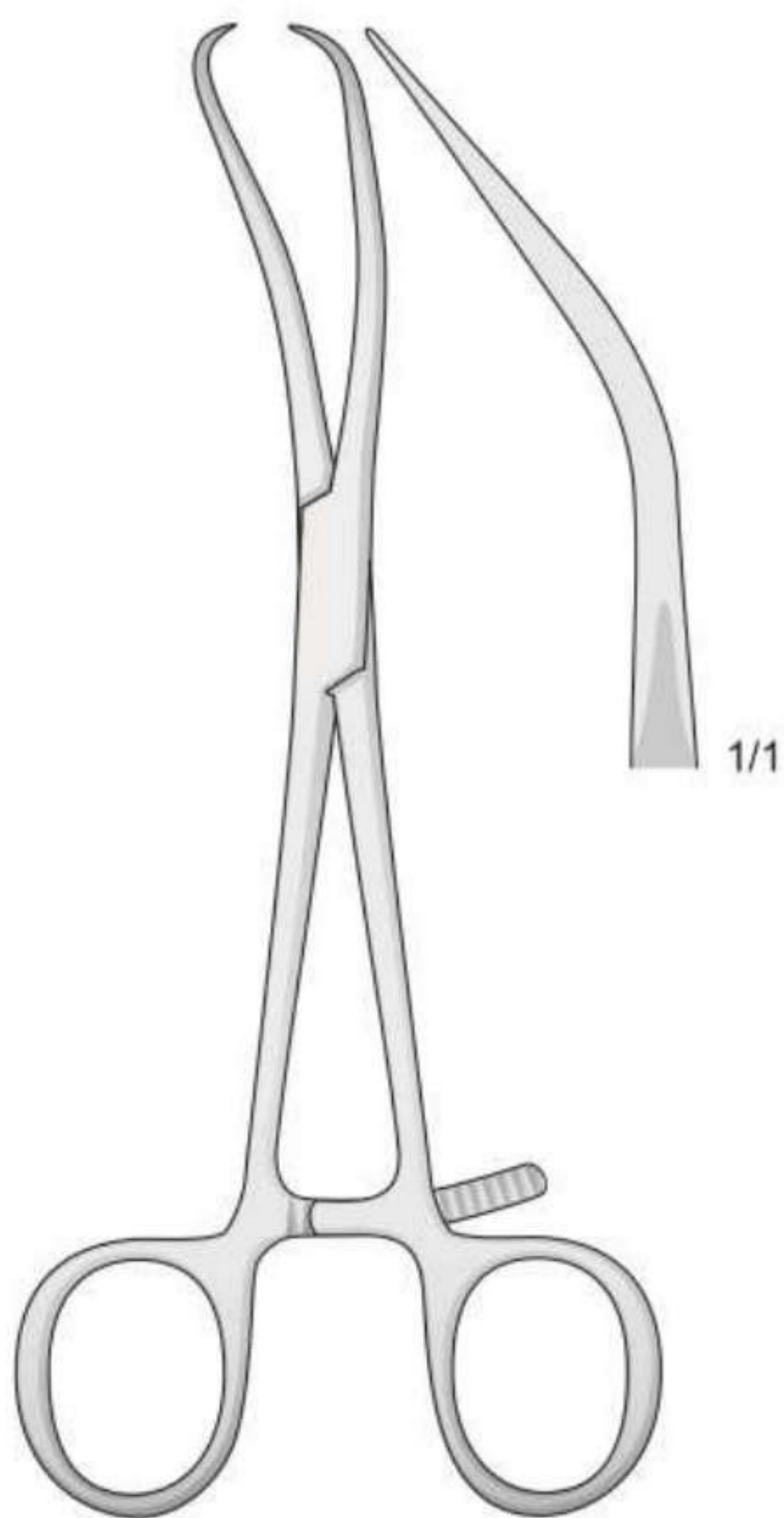

REILL
FO-64
170 mm

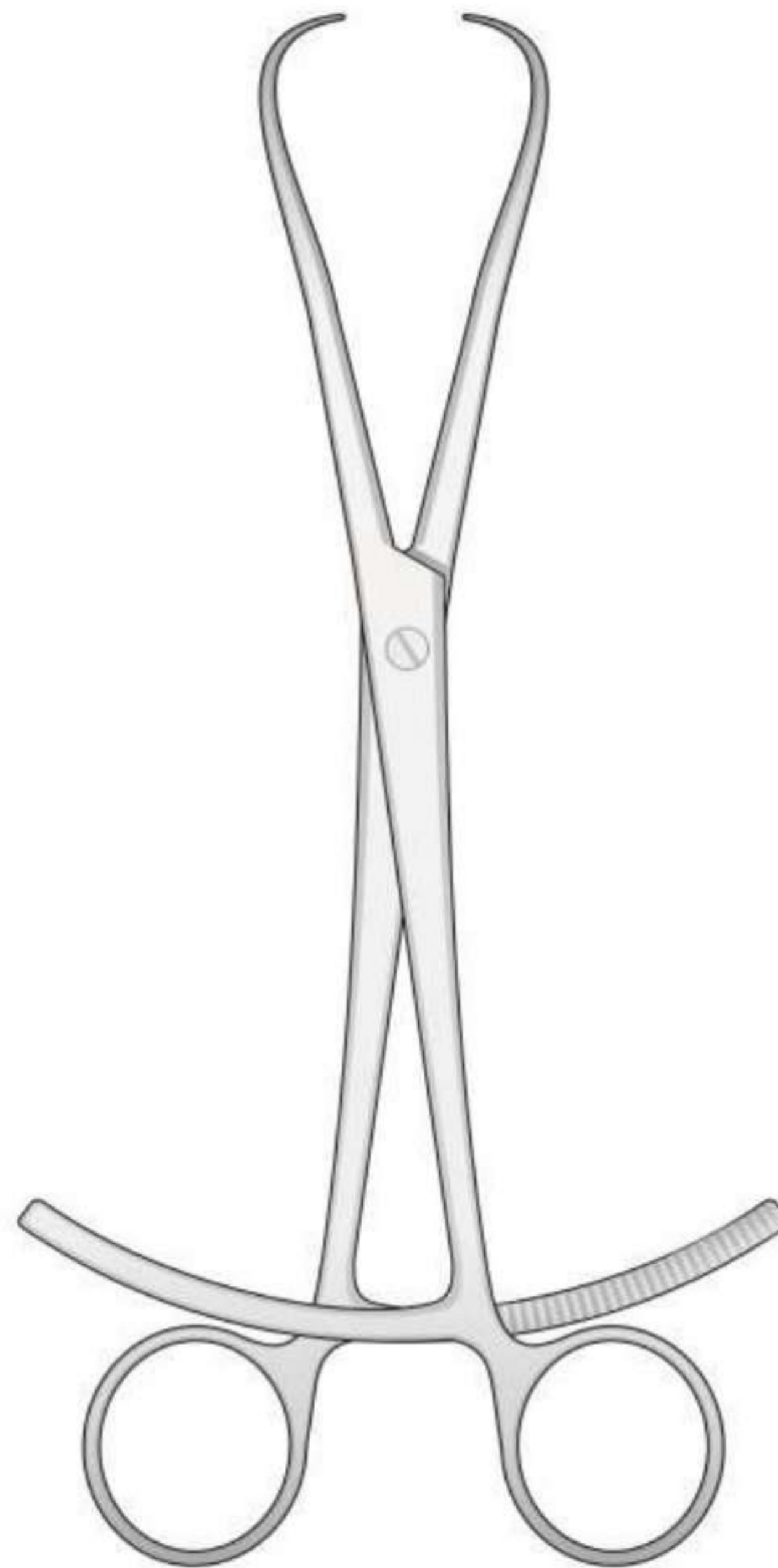

FO-68
200 mm

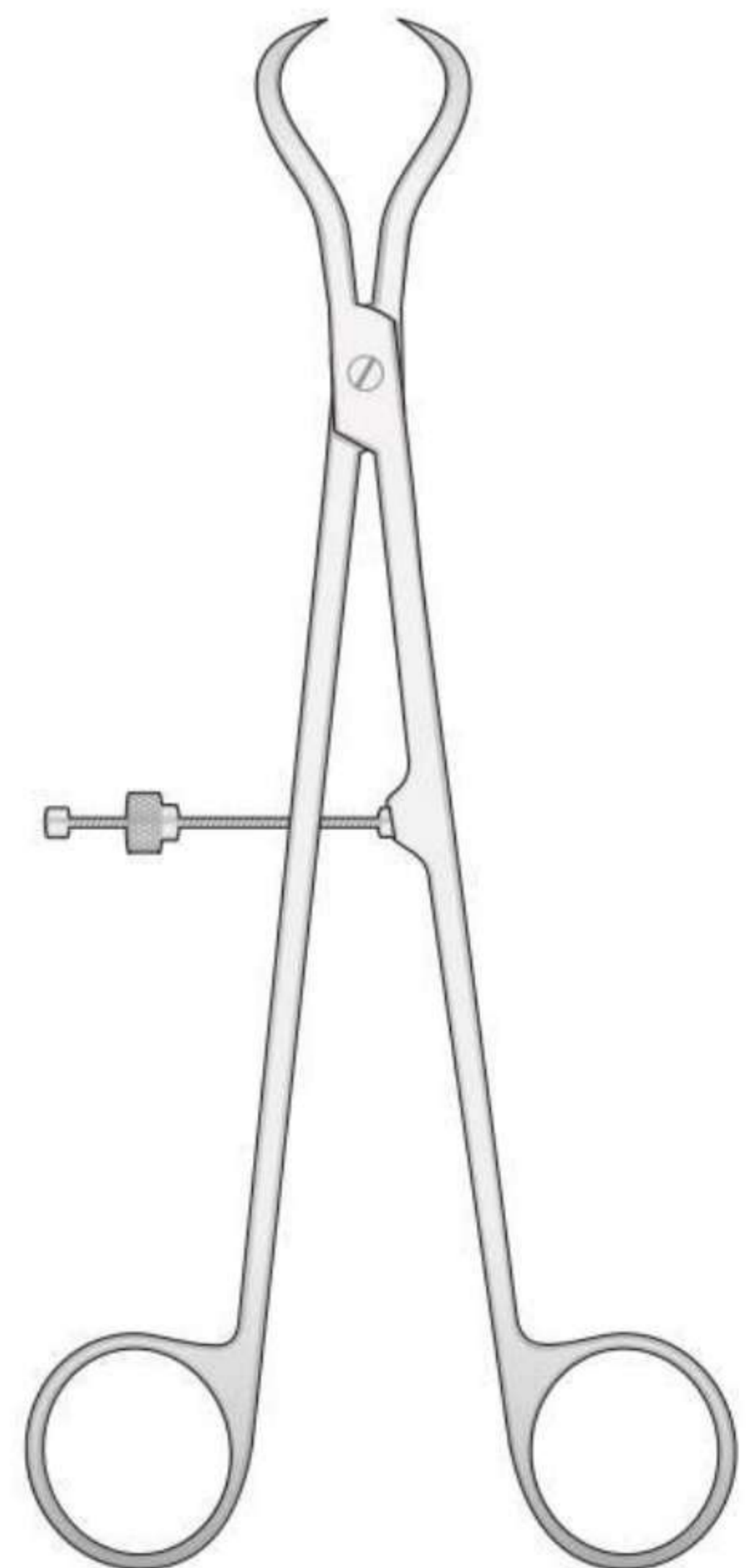

FO-81
210 mm

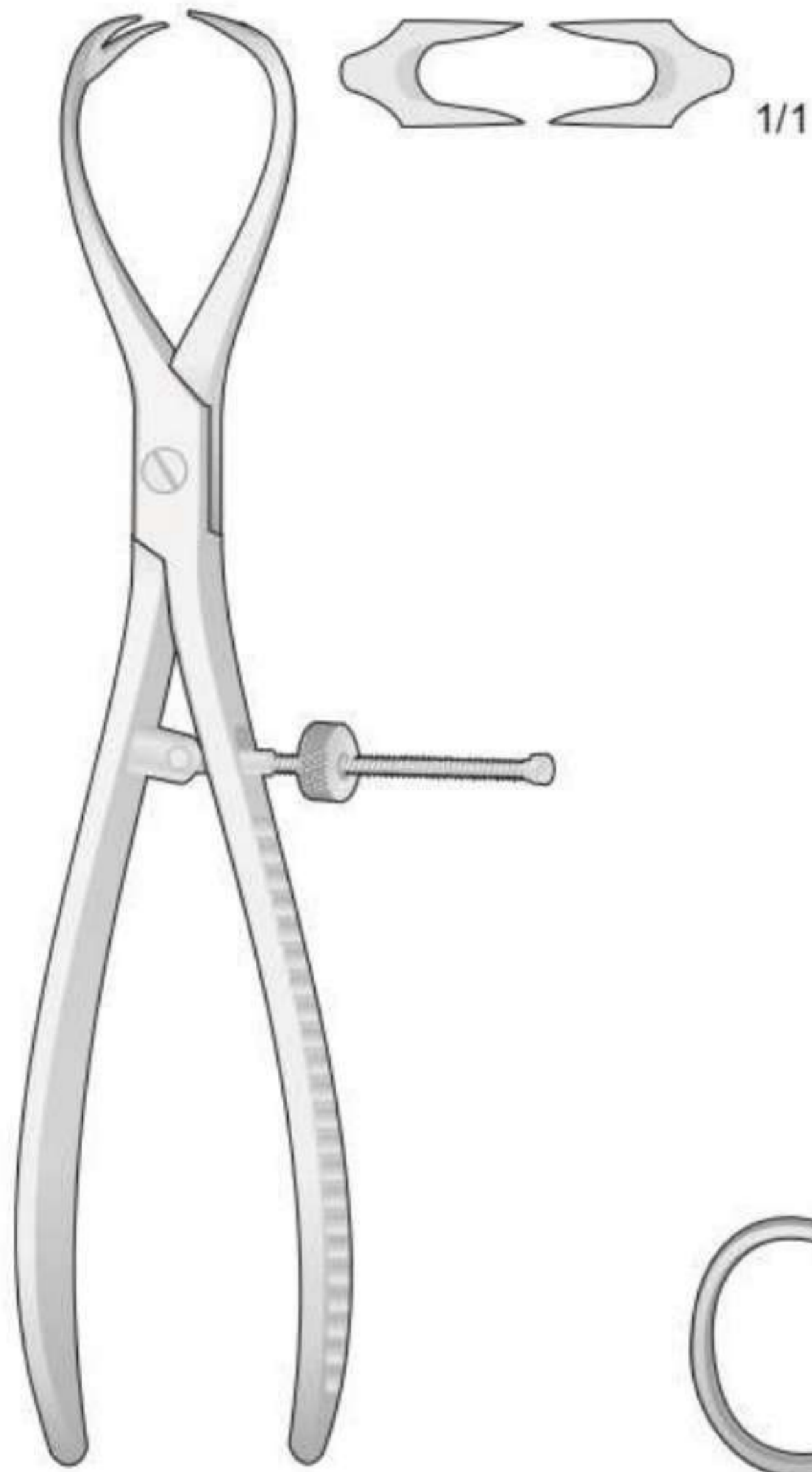

PATELLA
FO-46
185 mm

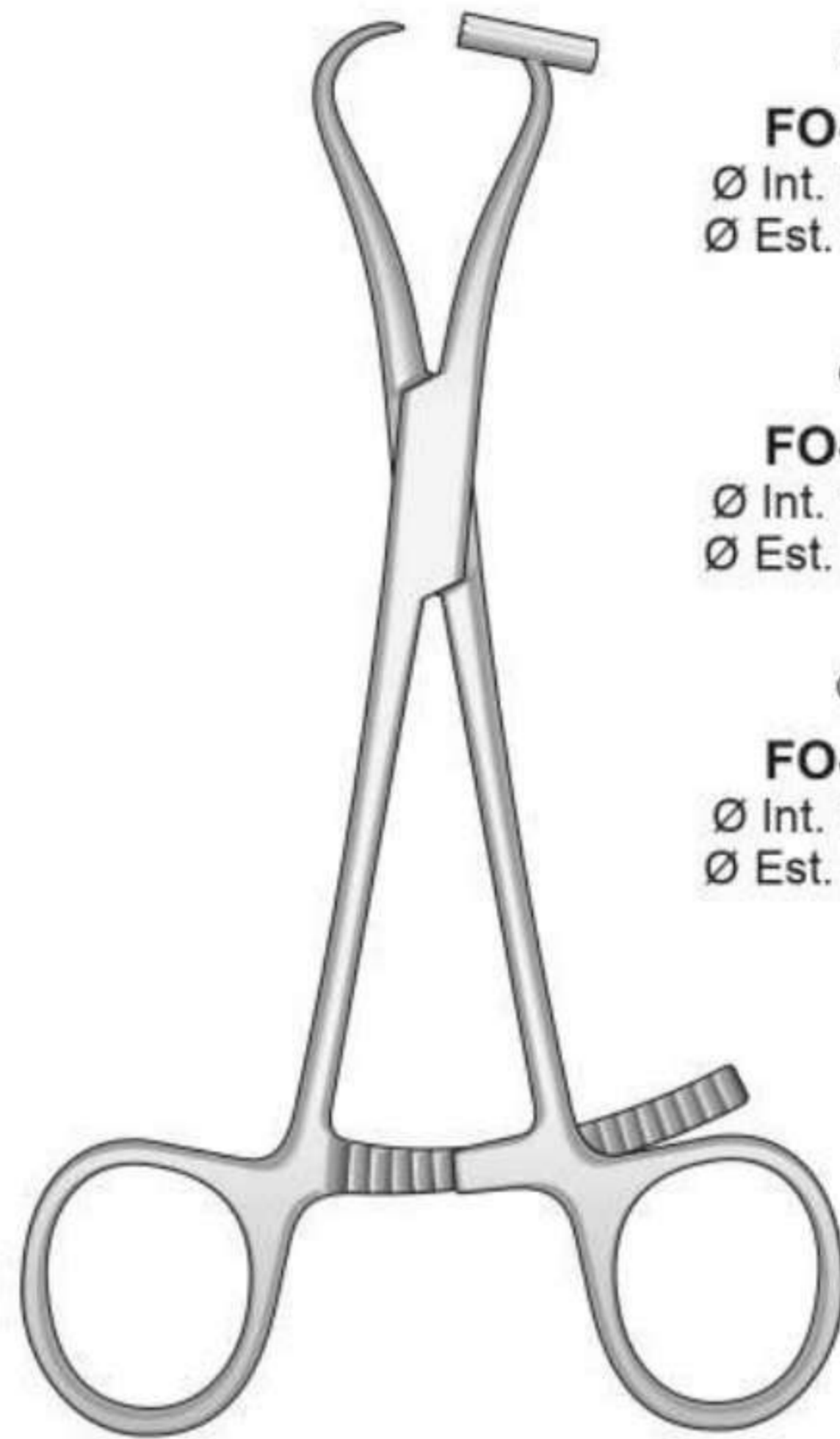

FO-240/FO-242
140 mm

- **FO-240**
Ø Int. 1,0 mm
Ø Est. 2,0 mm
- **FO-241**
Ø Int. 1,3 mm
Ø Est. 2,3 mm
- **FO-242**
Ø Int. 1,6 mm
Ø Est. 2,6 mm

Zange mit Gewindsperre
Forceps with thread fixation
Pinza con regolazione
Davier avec système d'arrêt fileté

Zange mit Zahnsperre
Forceps with ratchet fixation
Pinza con cremagliera
Davier à crémaillère

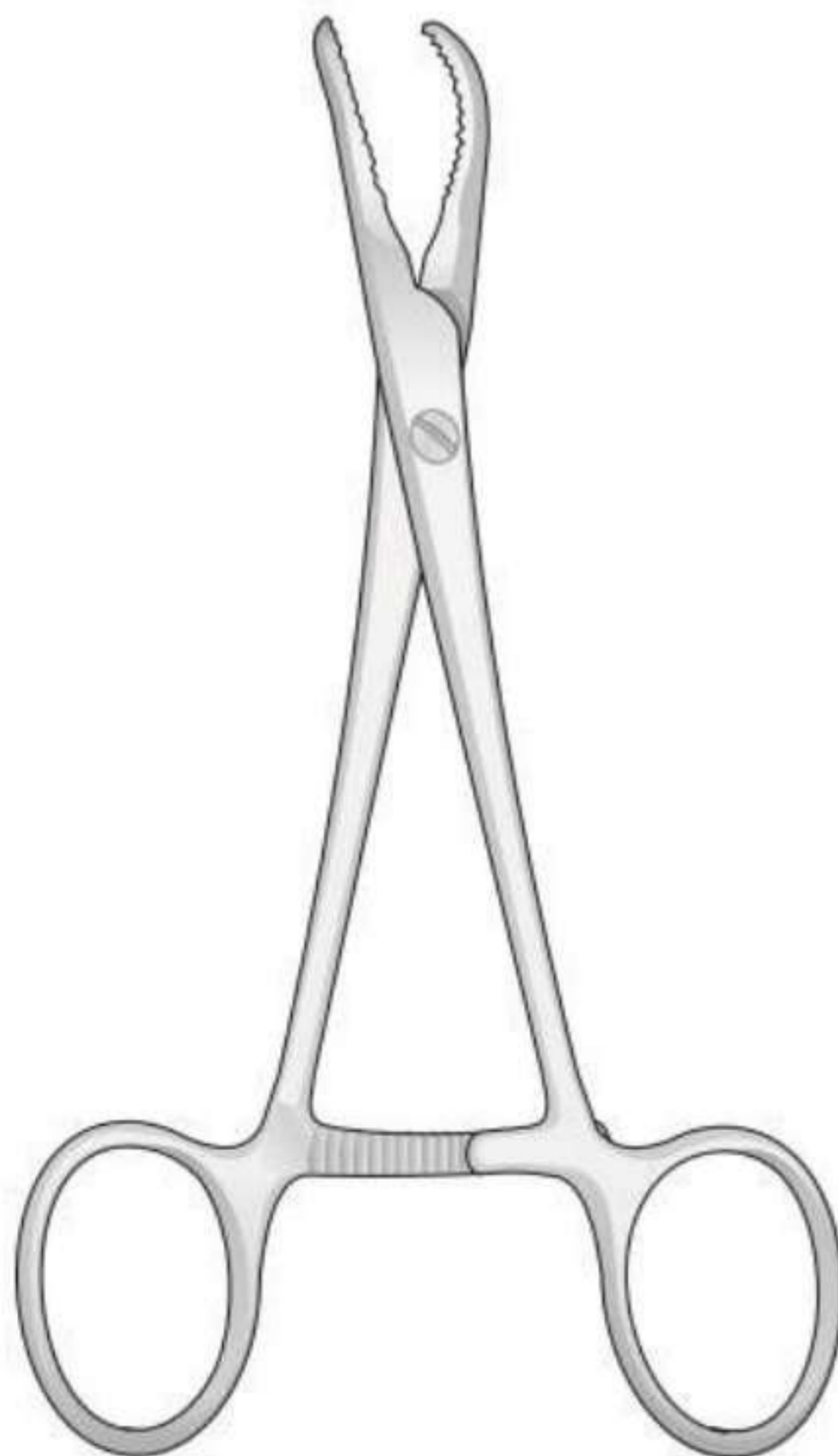

FO-47
140 mm

Zange mit Gewindsperre
Forceps with thread fixation
Pinza con regolazione
Davier avec système d'arrêt fileté

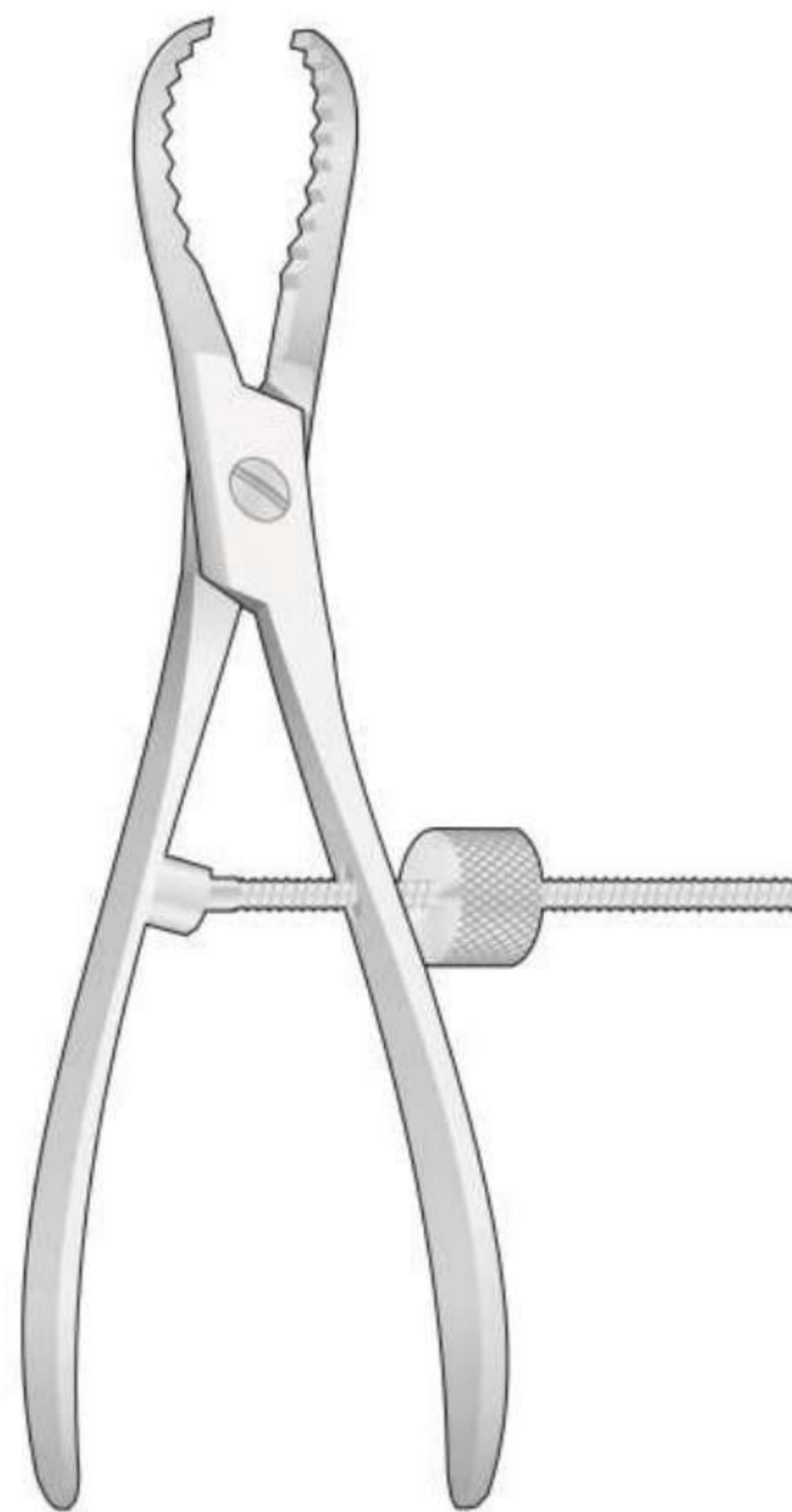

FO-48
170 mm

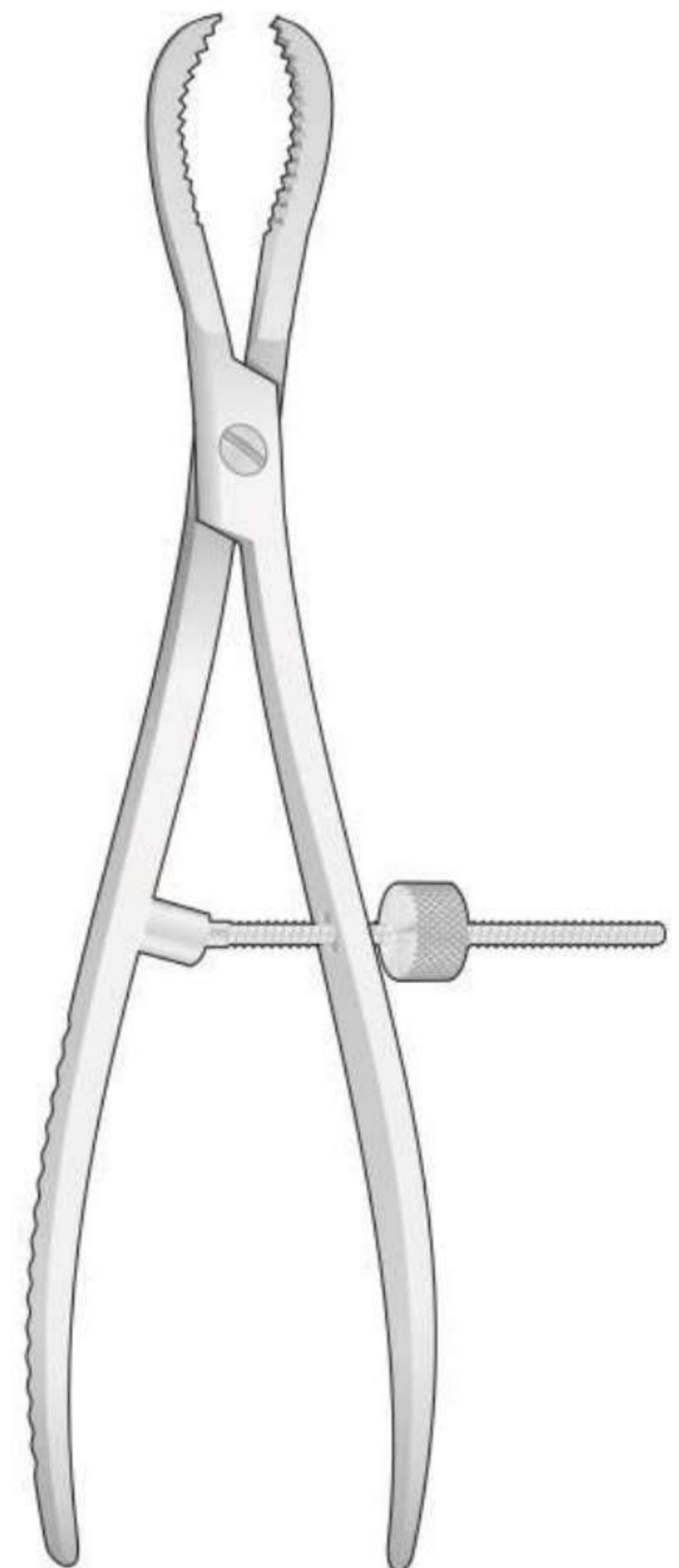

FO-49
235 mm

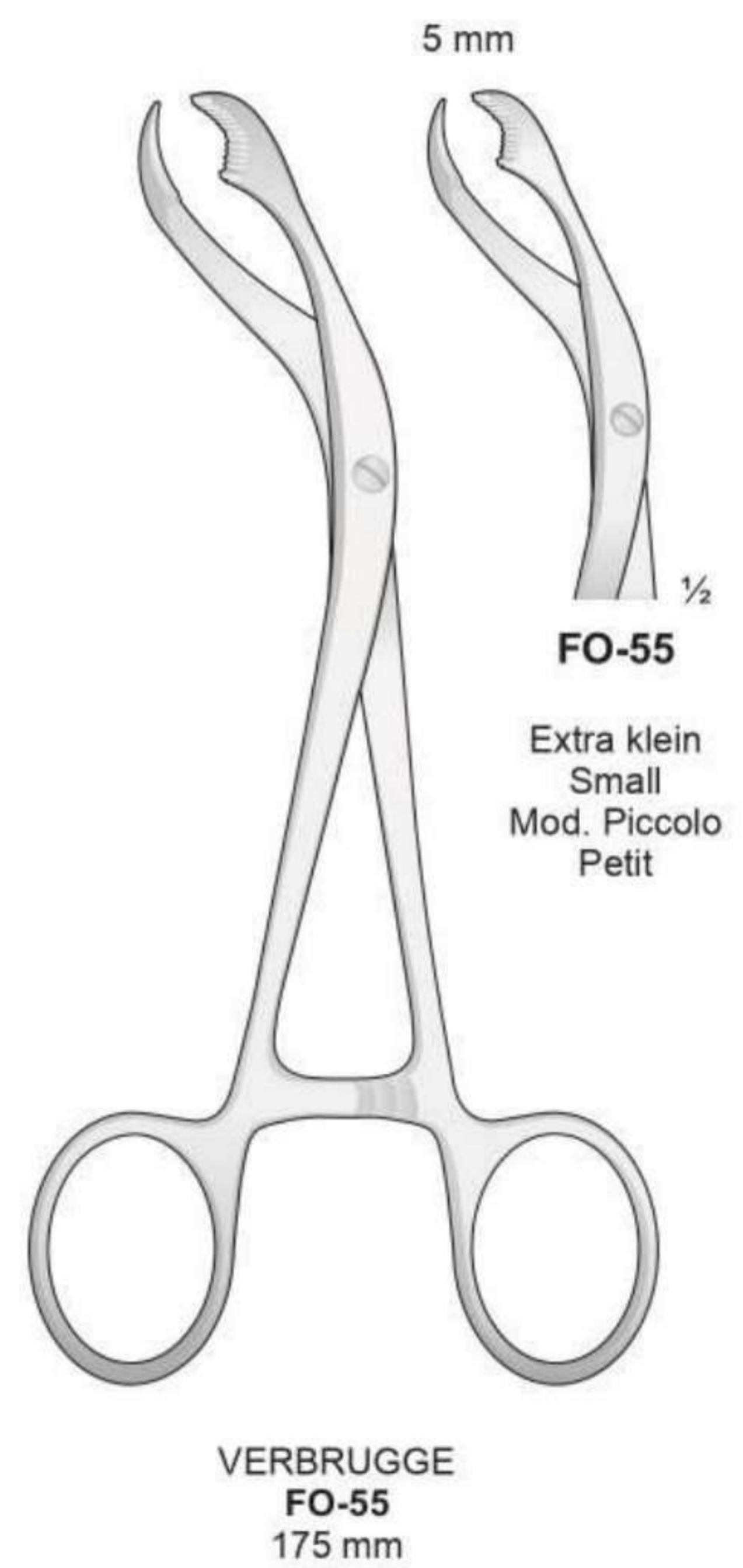
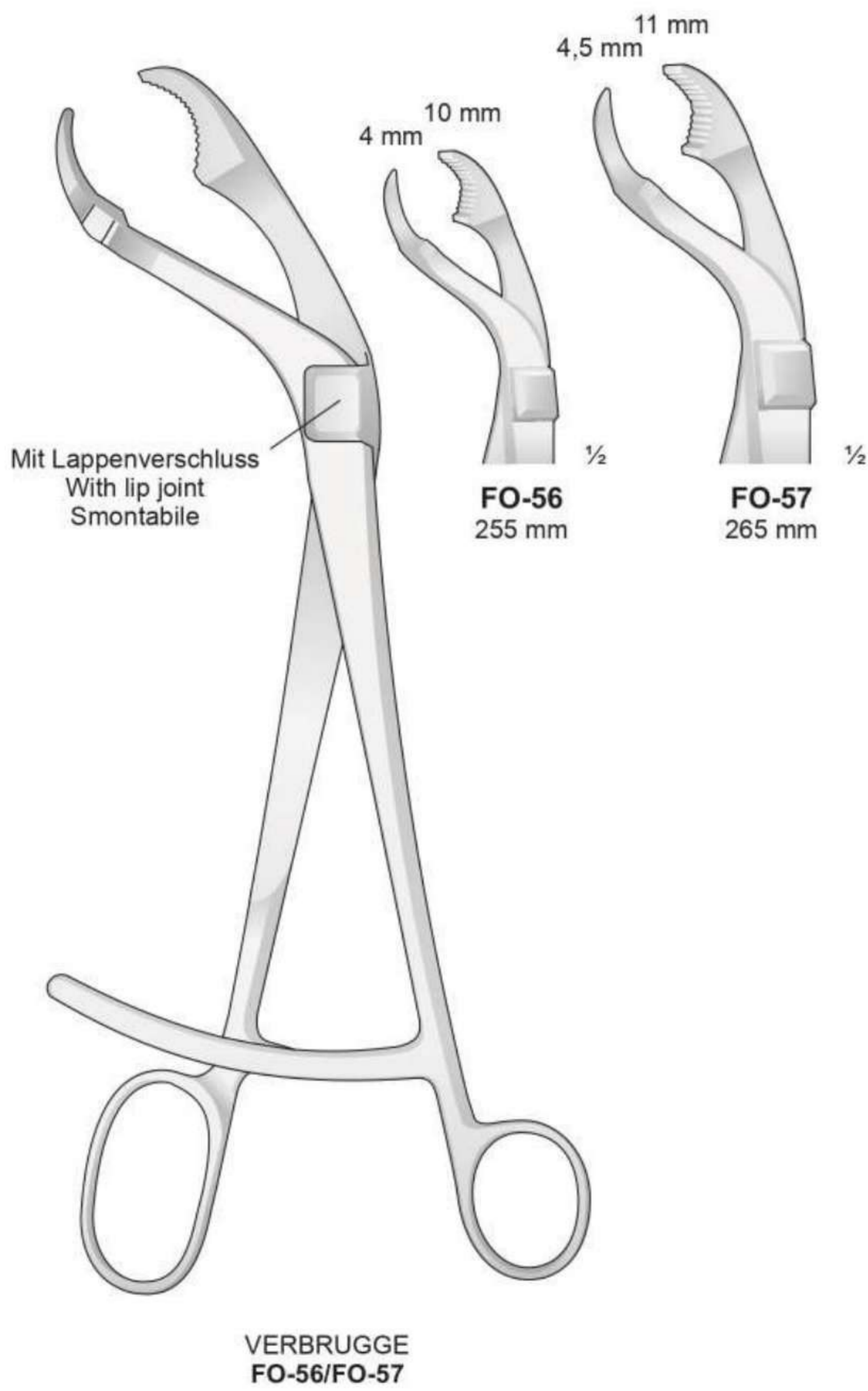

Selbstzentrierend mit Gewindesperre
 Self-centering bone holding forceps with thread lock
 Autocentrante con blocco
 À centrage automatique avec arrêt de filetage

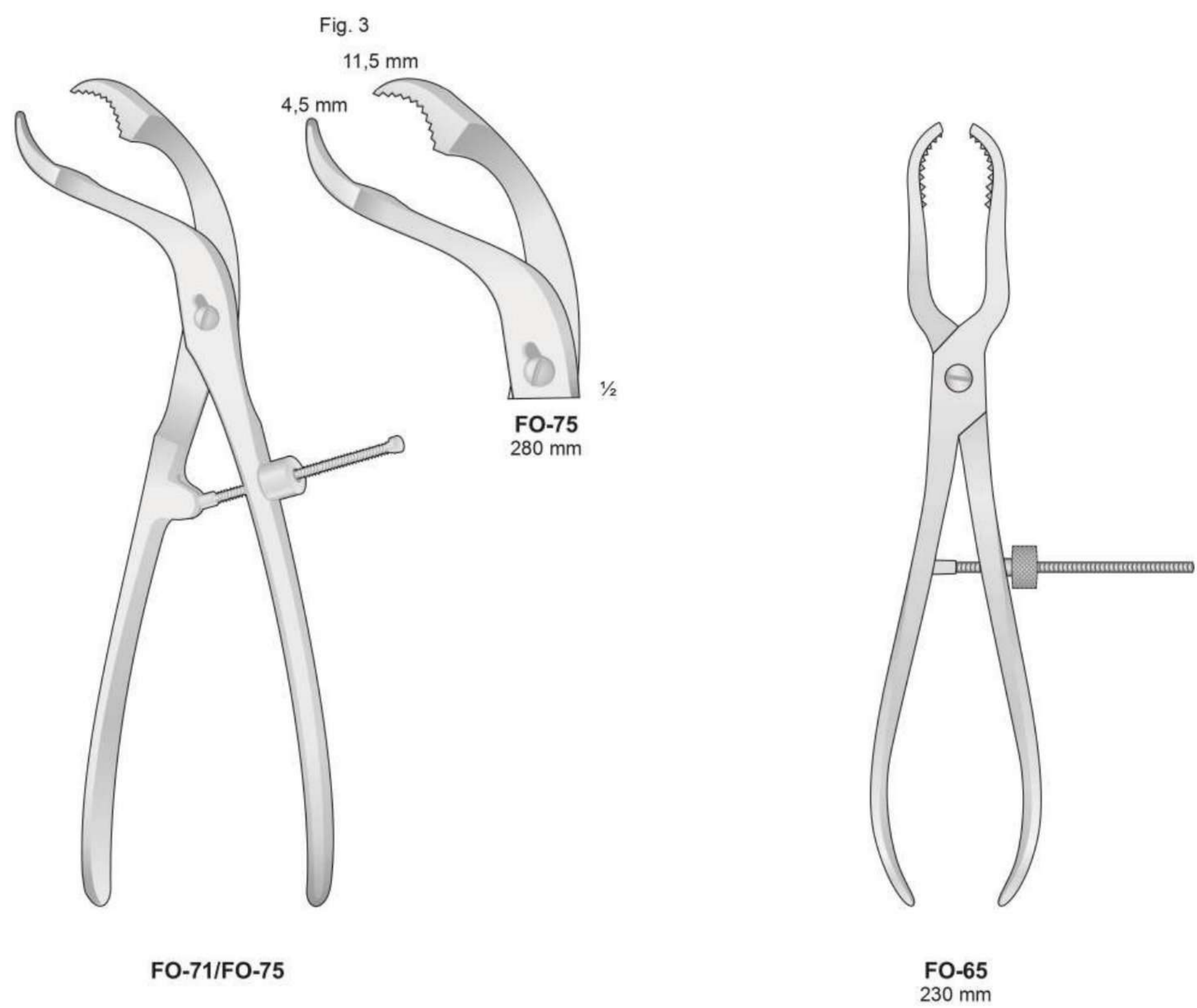
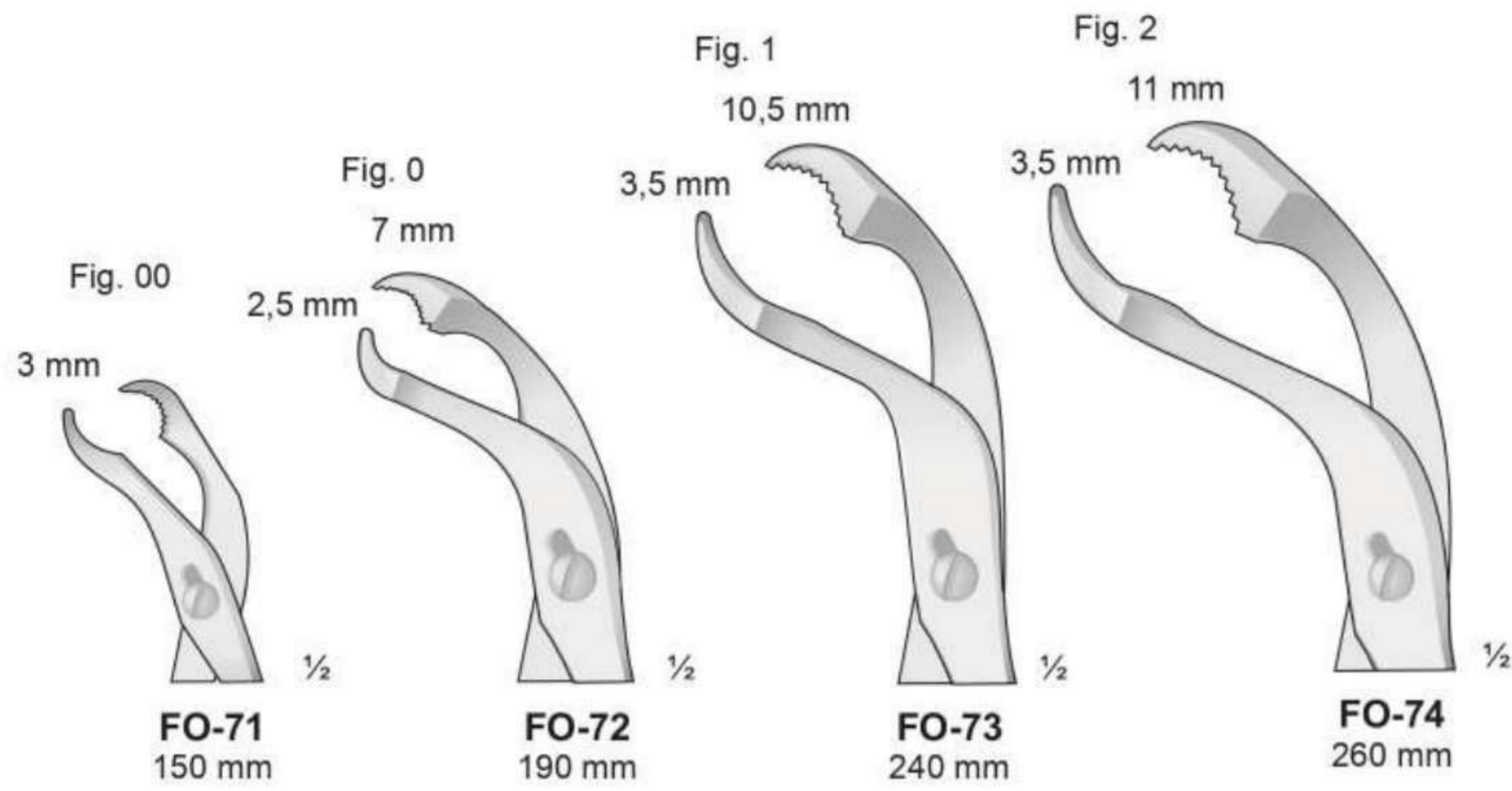

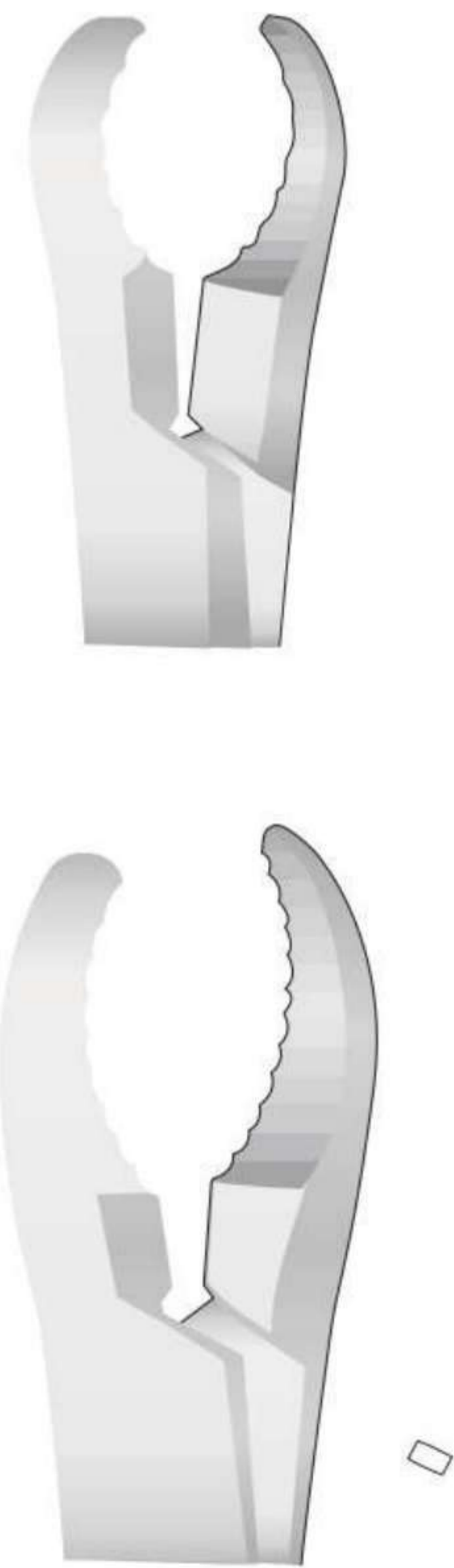
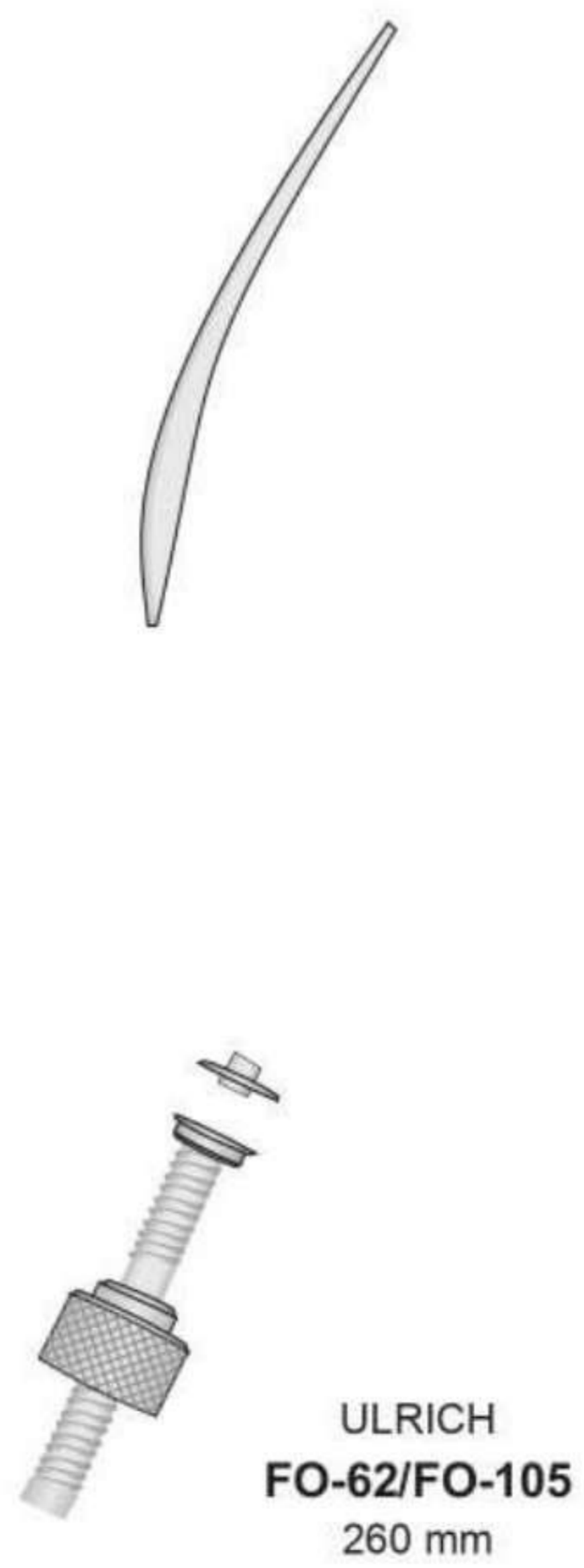
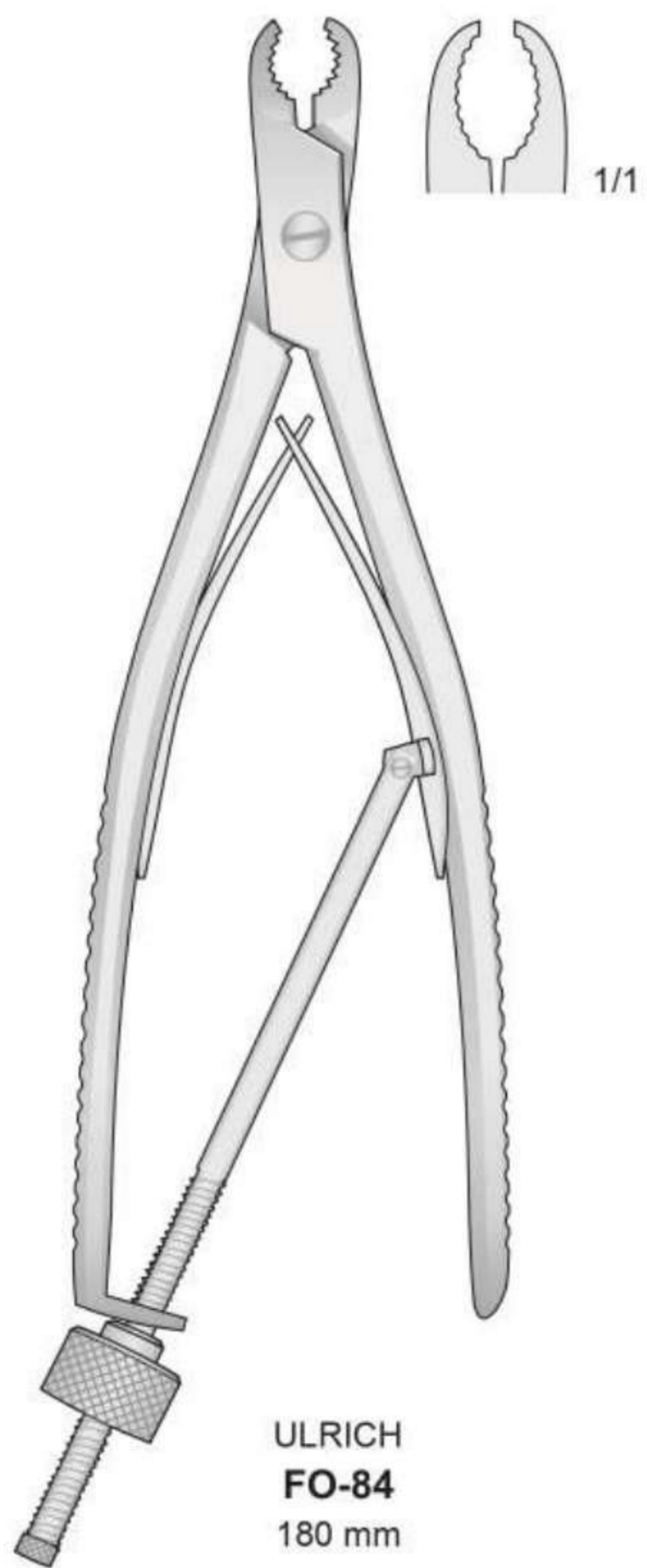

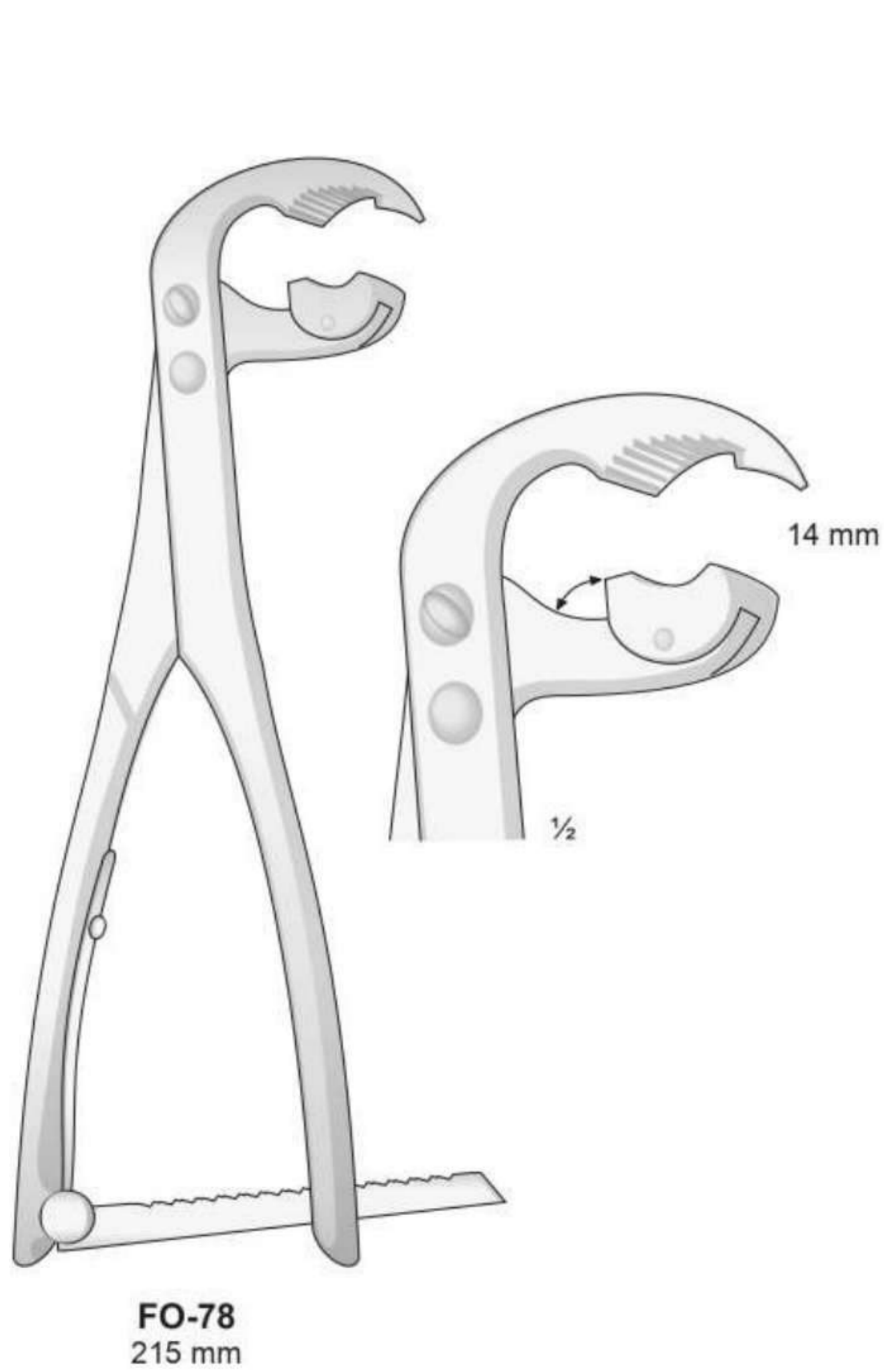
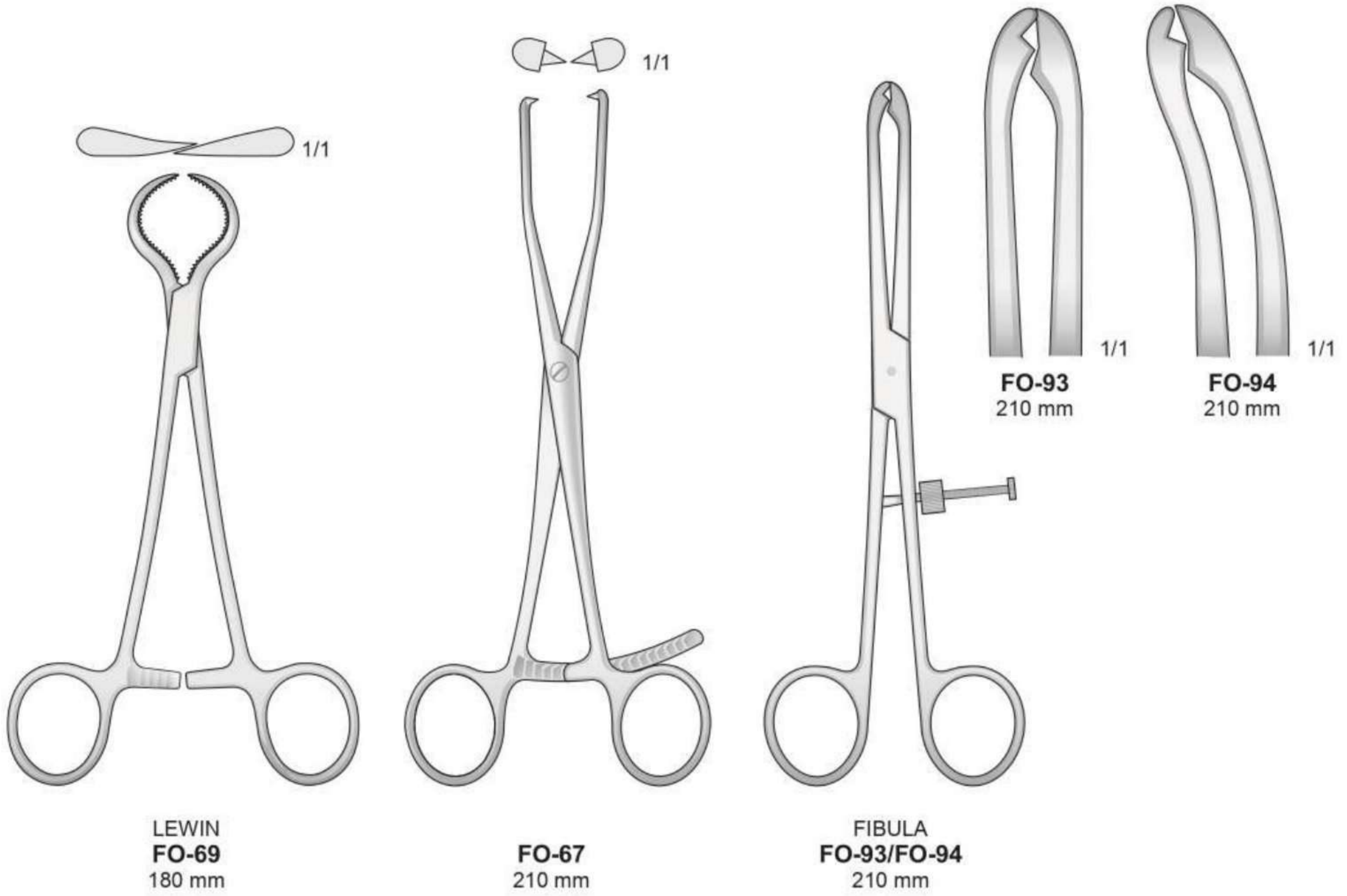

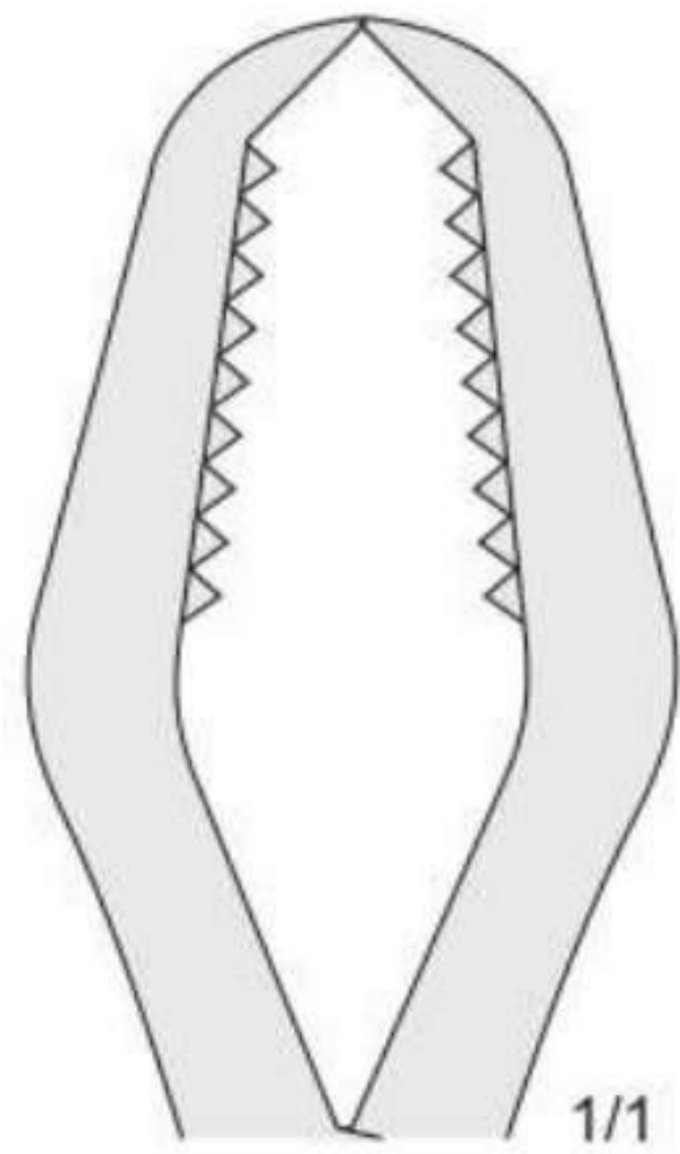

13 mm

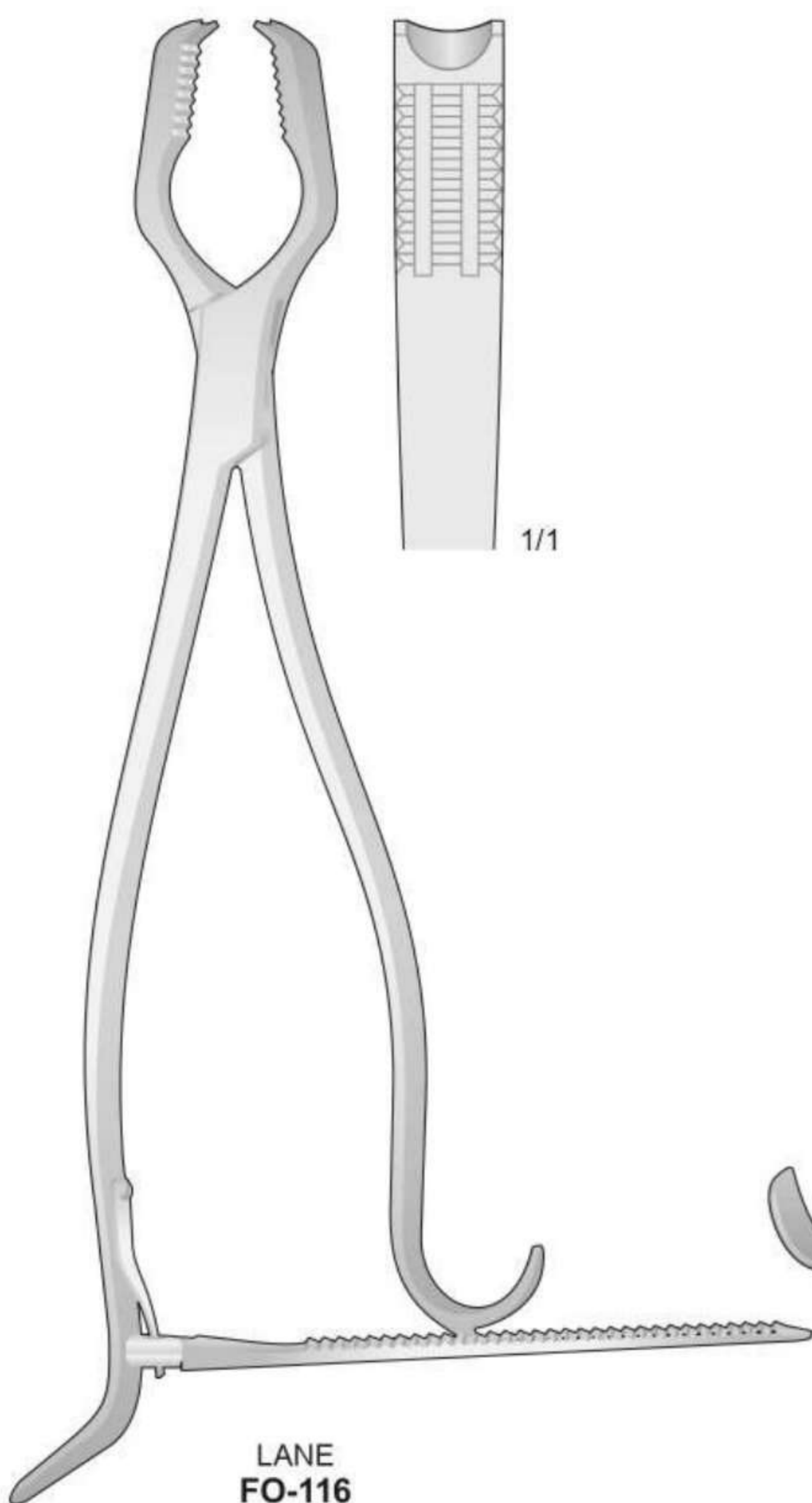

LANE
FO-116
320 mm

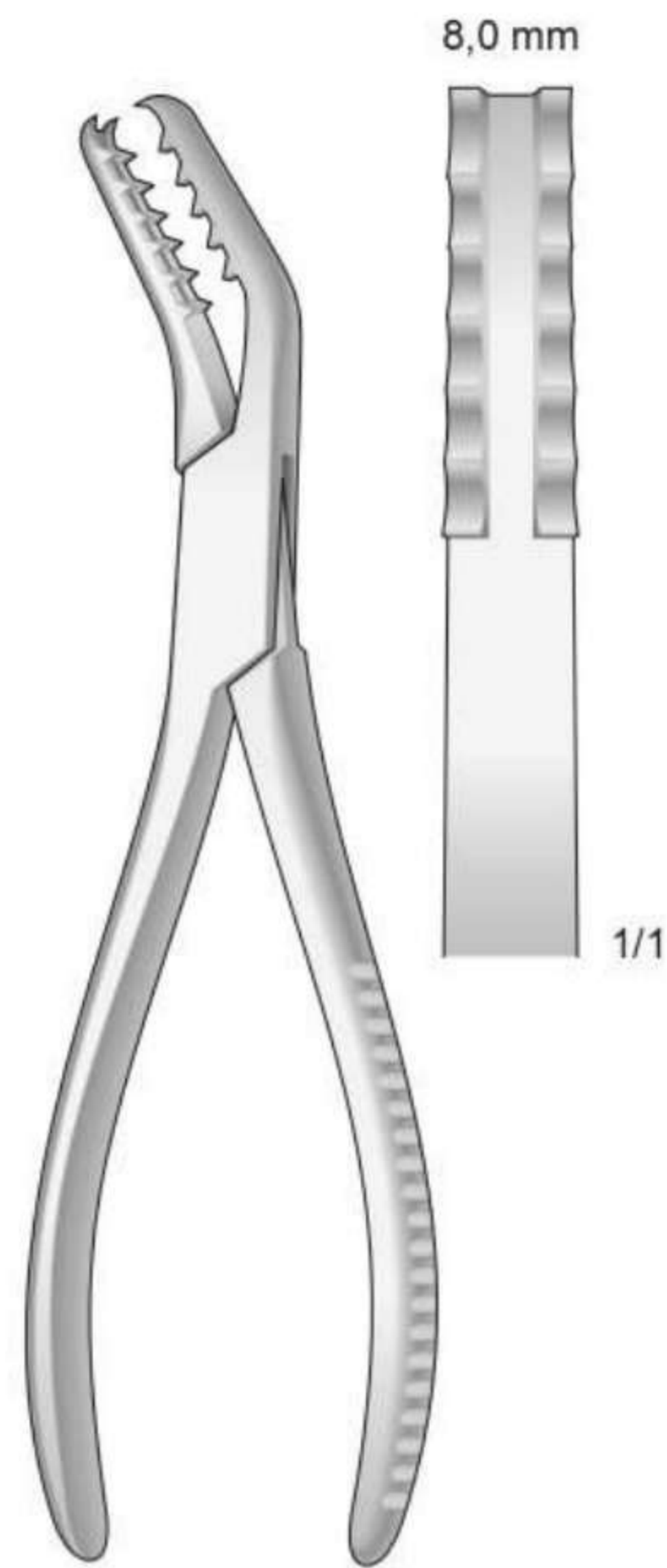

8,0 mm

1/1

SEMB
FO-236
190 mm

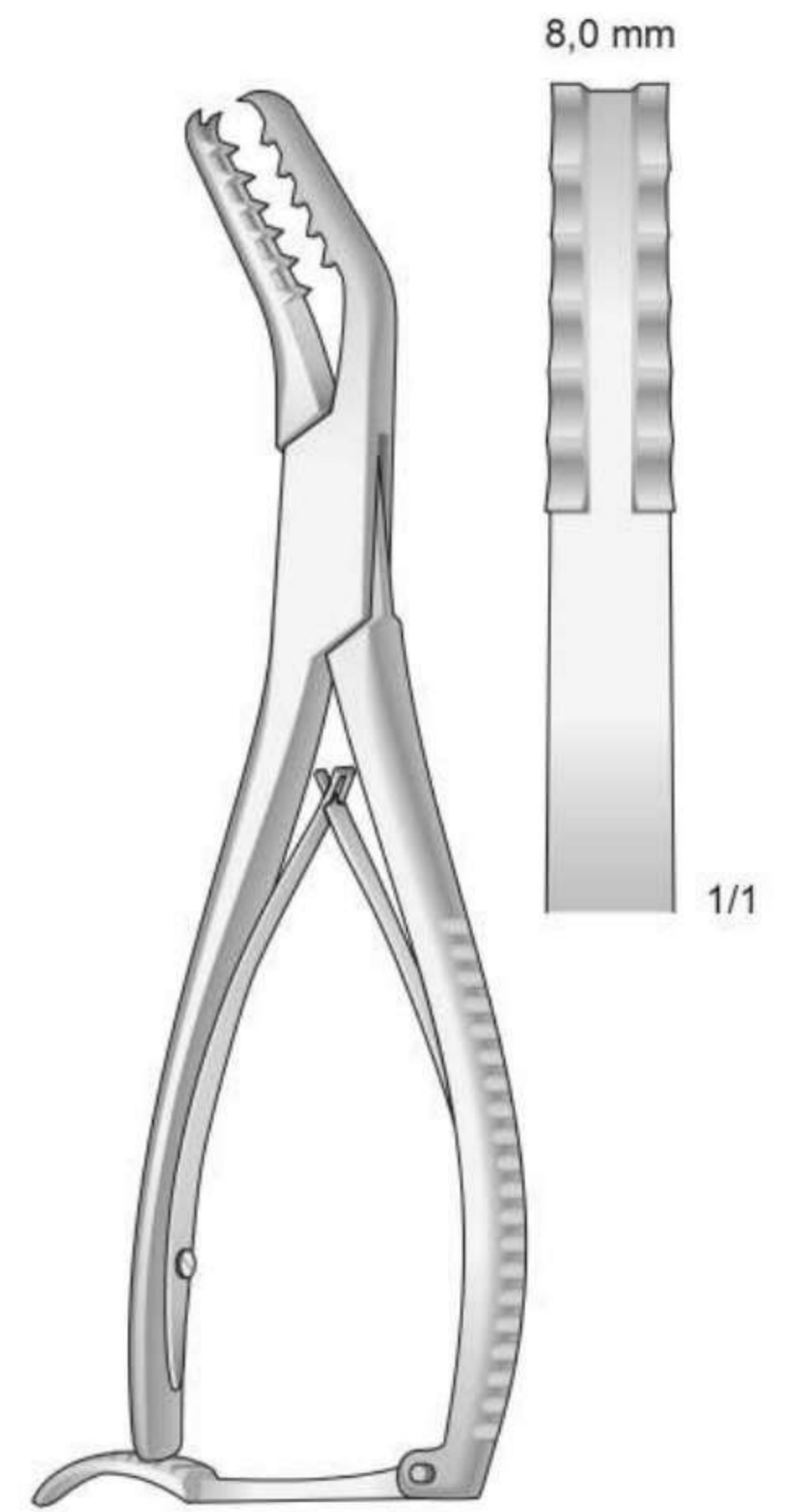

8,0 mm

1/1

SEMB
FO-237
190 mm

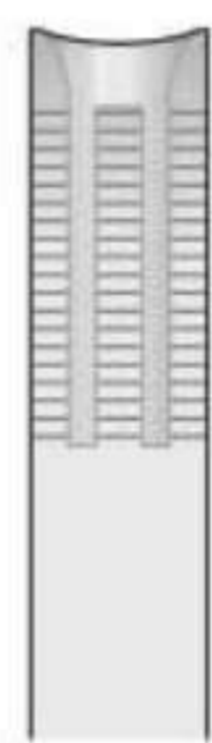
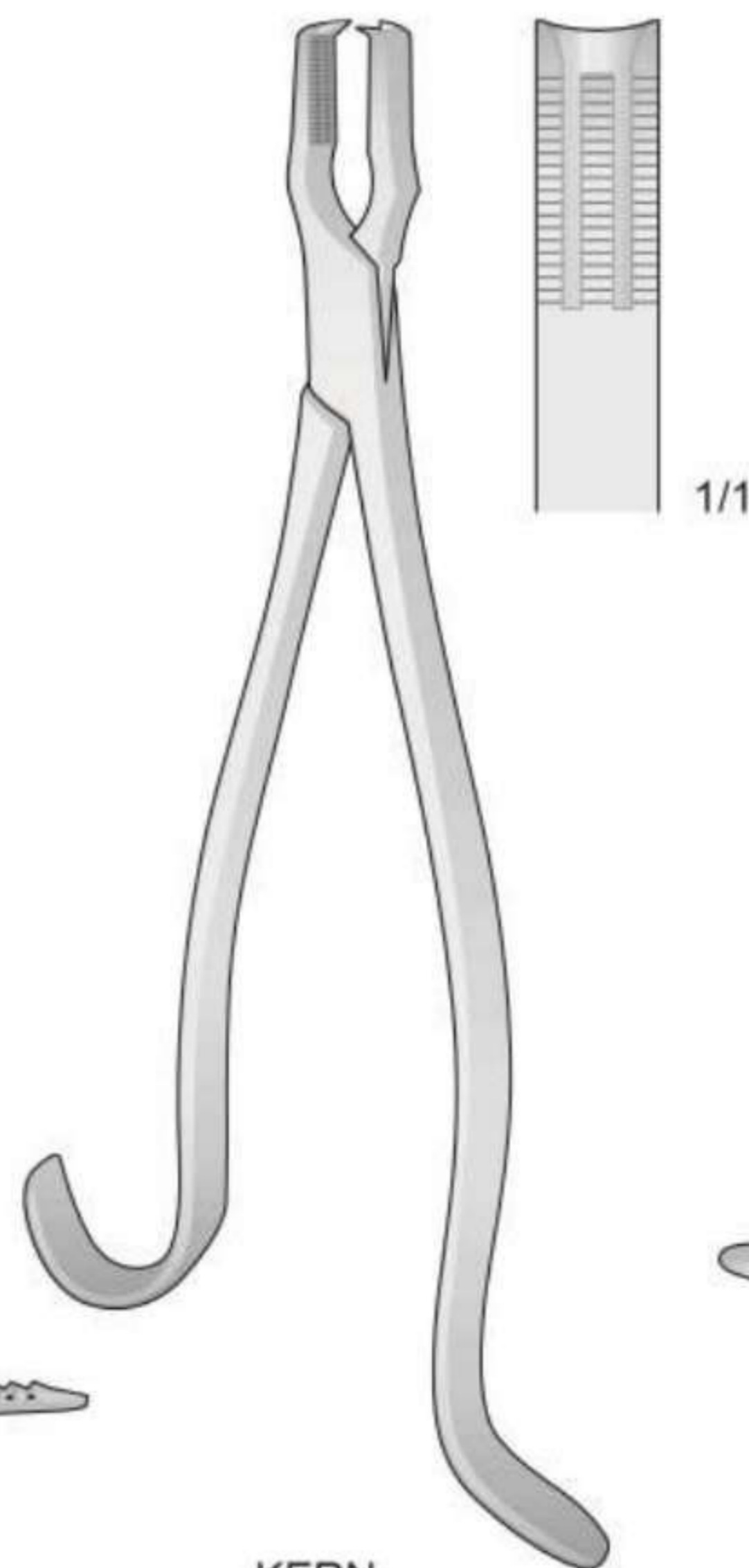

KERN
FO-114 170 mm
FO-115 220 mm

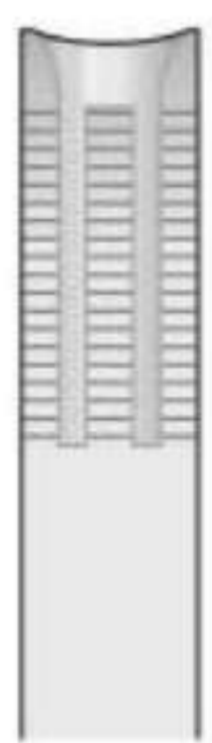
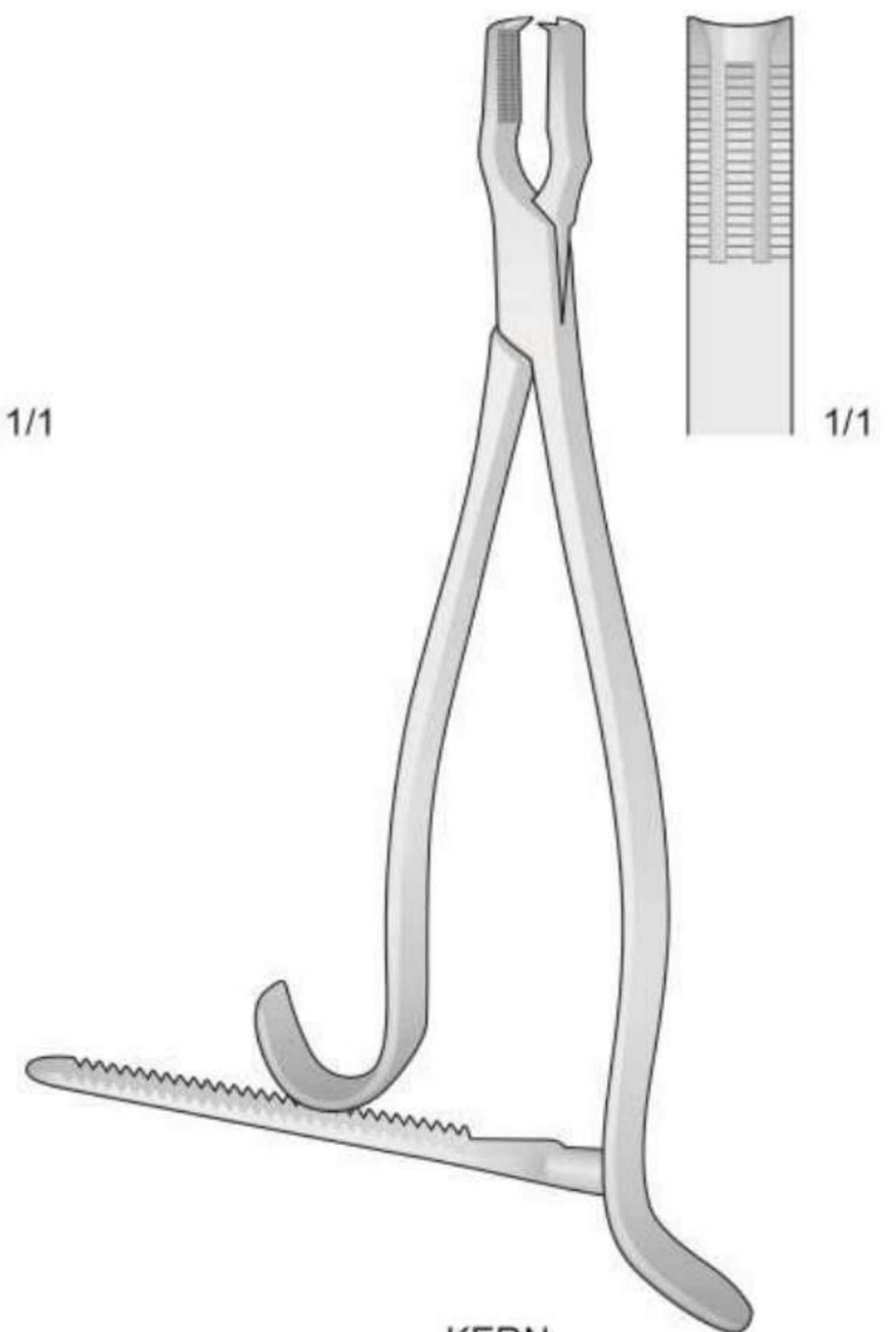

KERN
FO-110 170 mm
FO-112 220 mm



LANGENBECK
FO-99
200 mm



LANGENBECK
FO-111
205 mm



FERGUSON
FO-113
205 mm

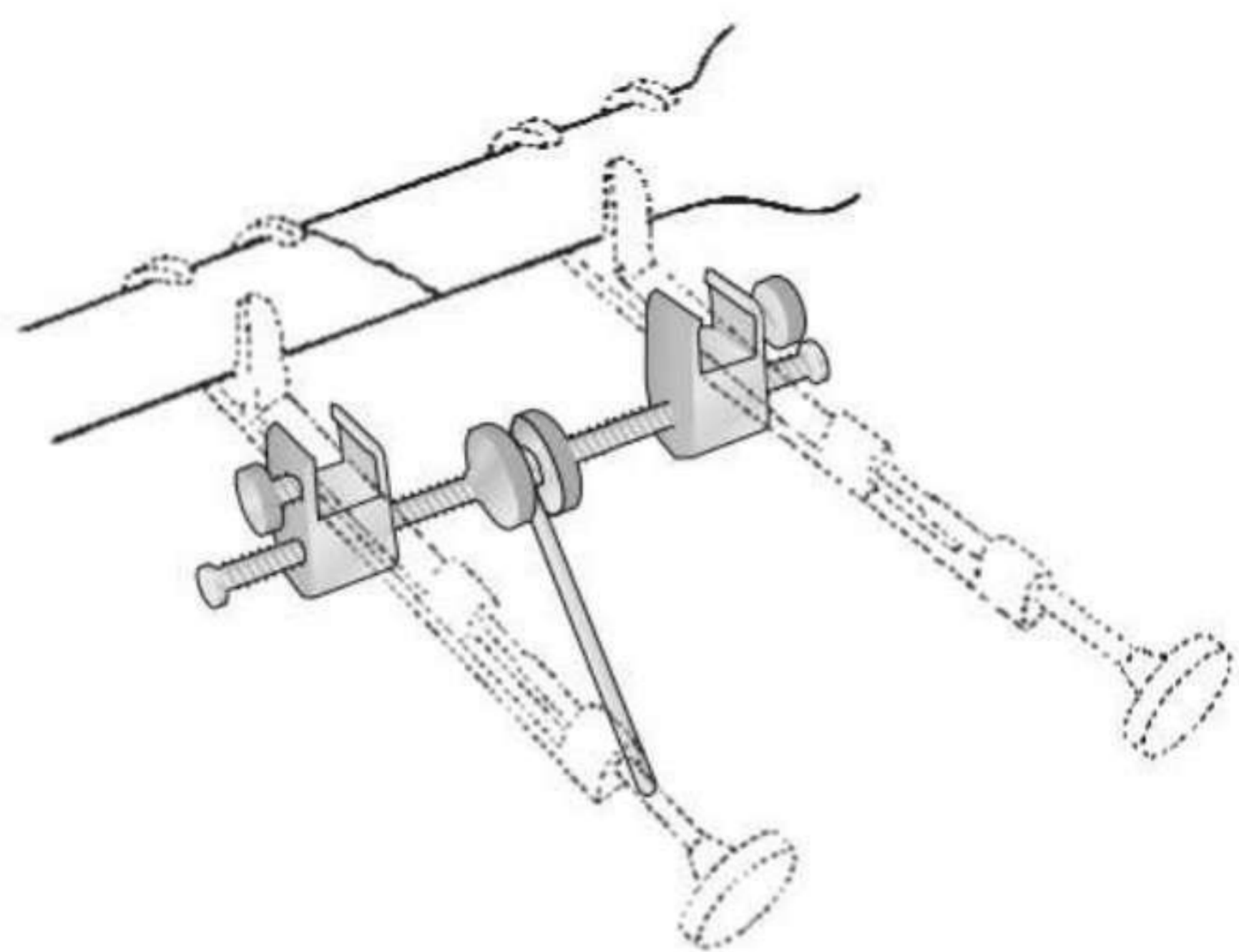

GERSTER
FO-96

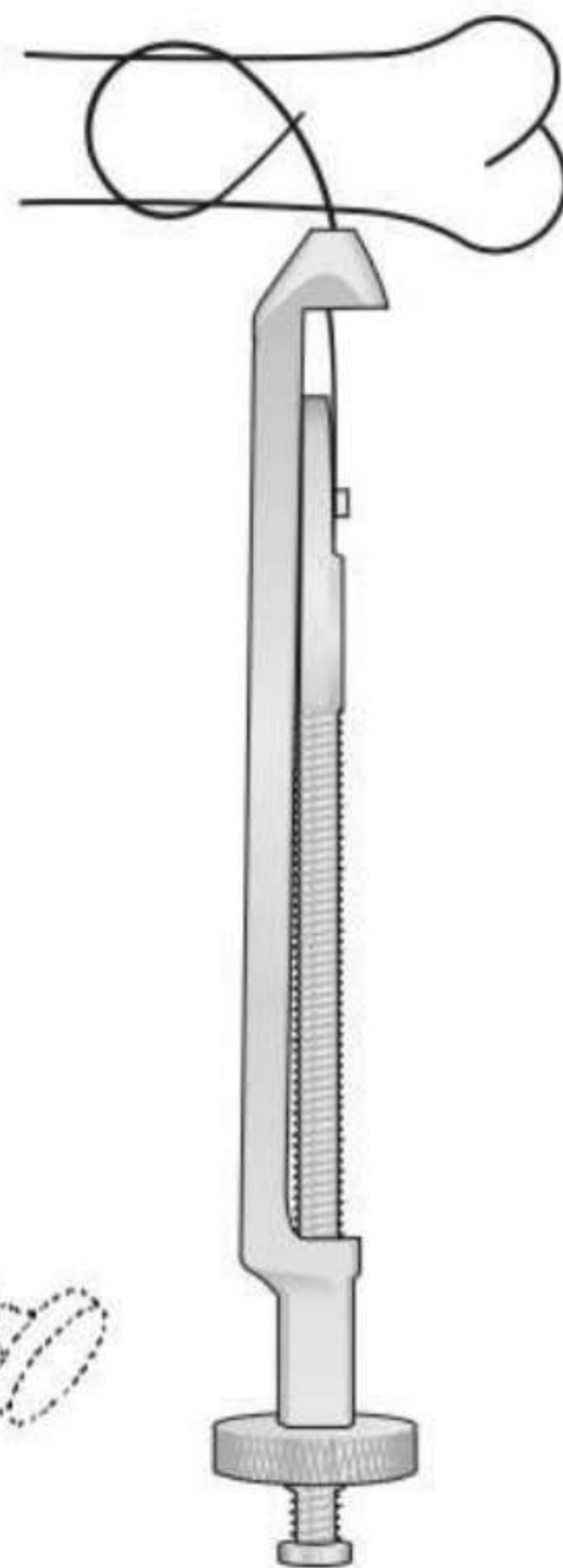

PARHAM
FO-98
175 mm

Matrice di ricambio per FO-98



FO-97
190 mm



GERSTER-LOWMAN
FO-90 120 mm
FO-91 185 mm
FO-92 200 mm

Für kinder
For children
Per bambini
Para niños
Pour enfants

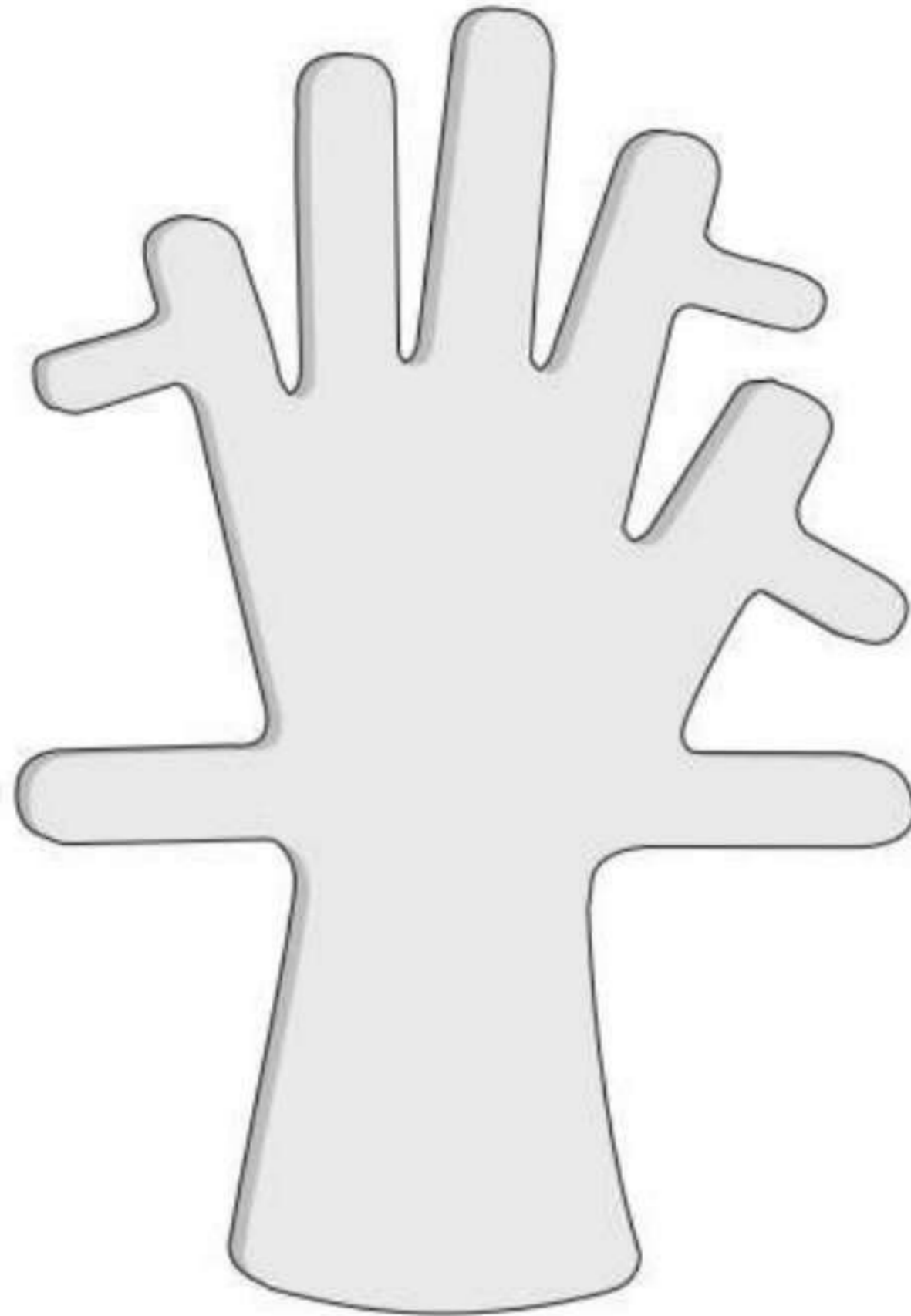

FO-299

Für Erwachsene - For adults - Per adulti
Para adultos - Pour adultes

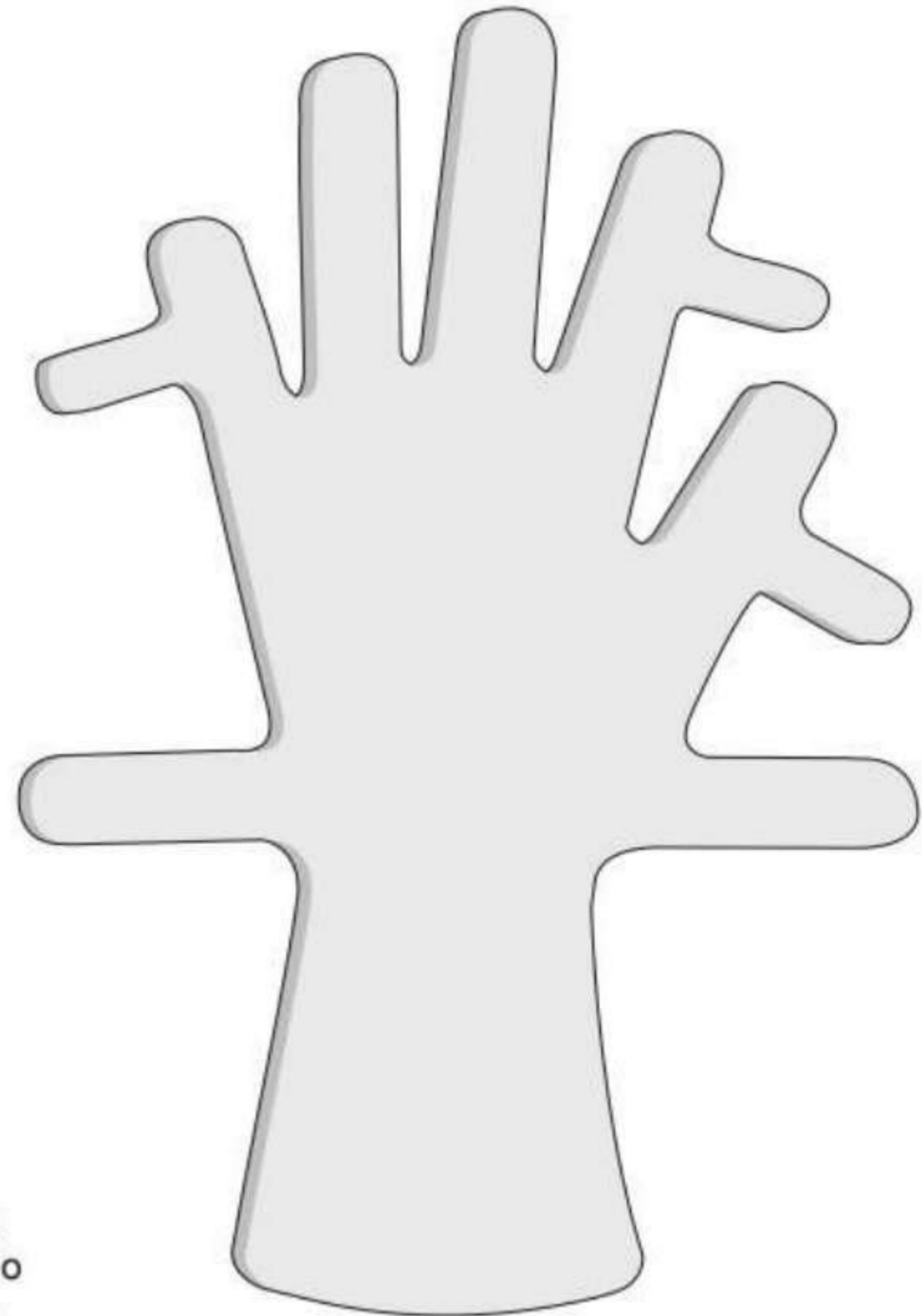

FO-300

Bleihände
Lead hands
Mani di piombo
Manos de plombo
Main de plomb

Fingerringsägen - Forceps for opening rings
Pinza taglia anelli - Sierra para anillos - Scies pour bagues

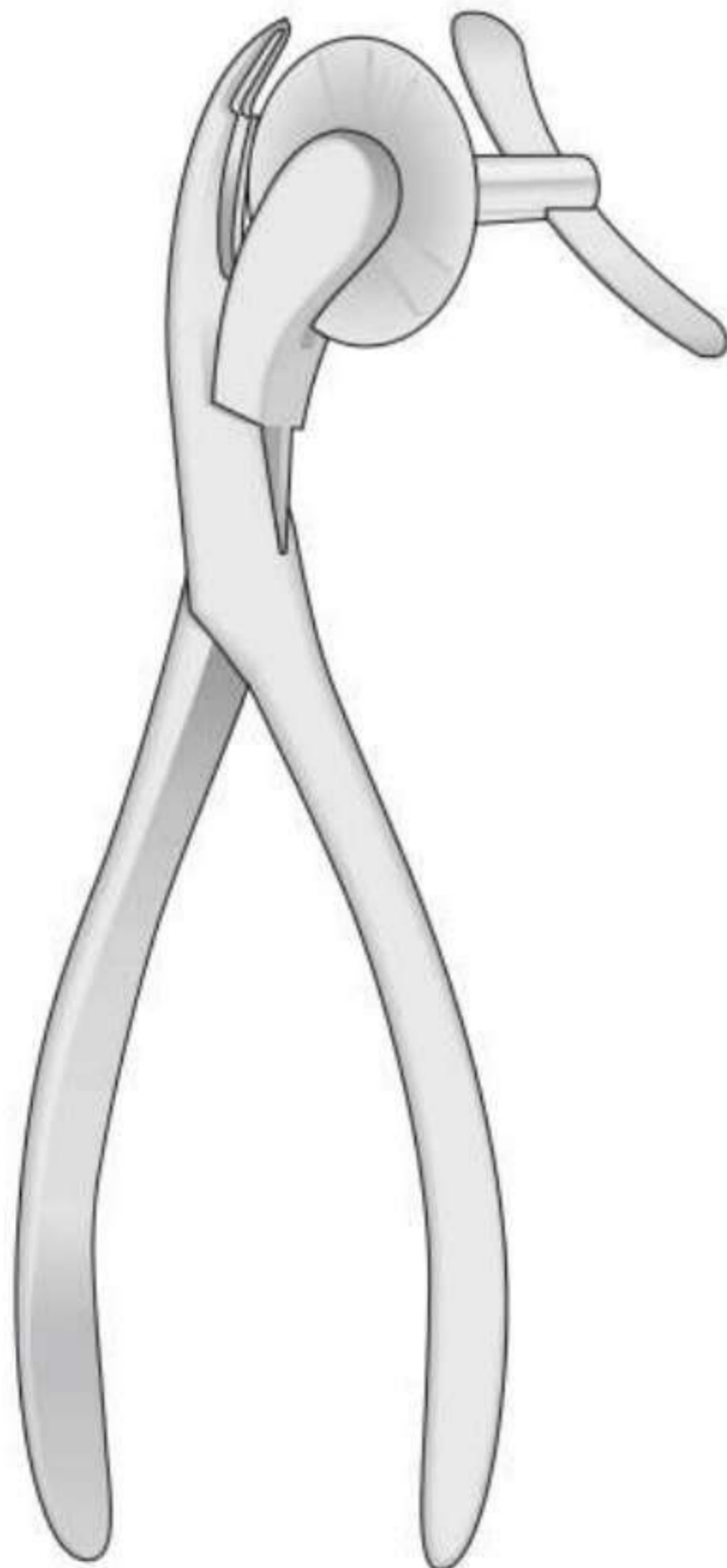

FO-80
170 mm

Nagel -Ausreisszange
Nail extracting forceps
Pinza per estrazione delle unghie
Pinzas para arrancar uñas
Pince pour extraire les ongles

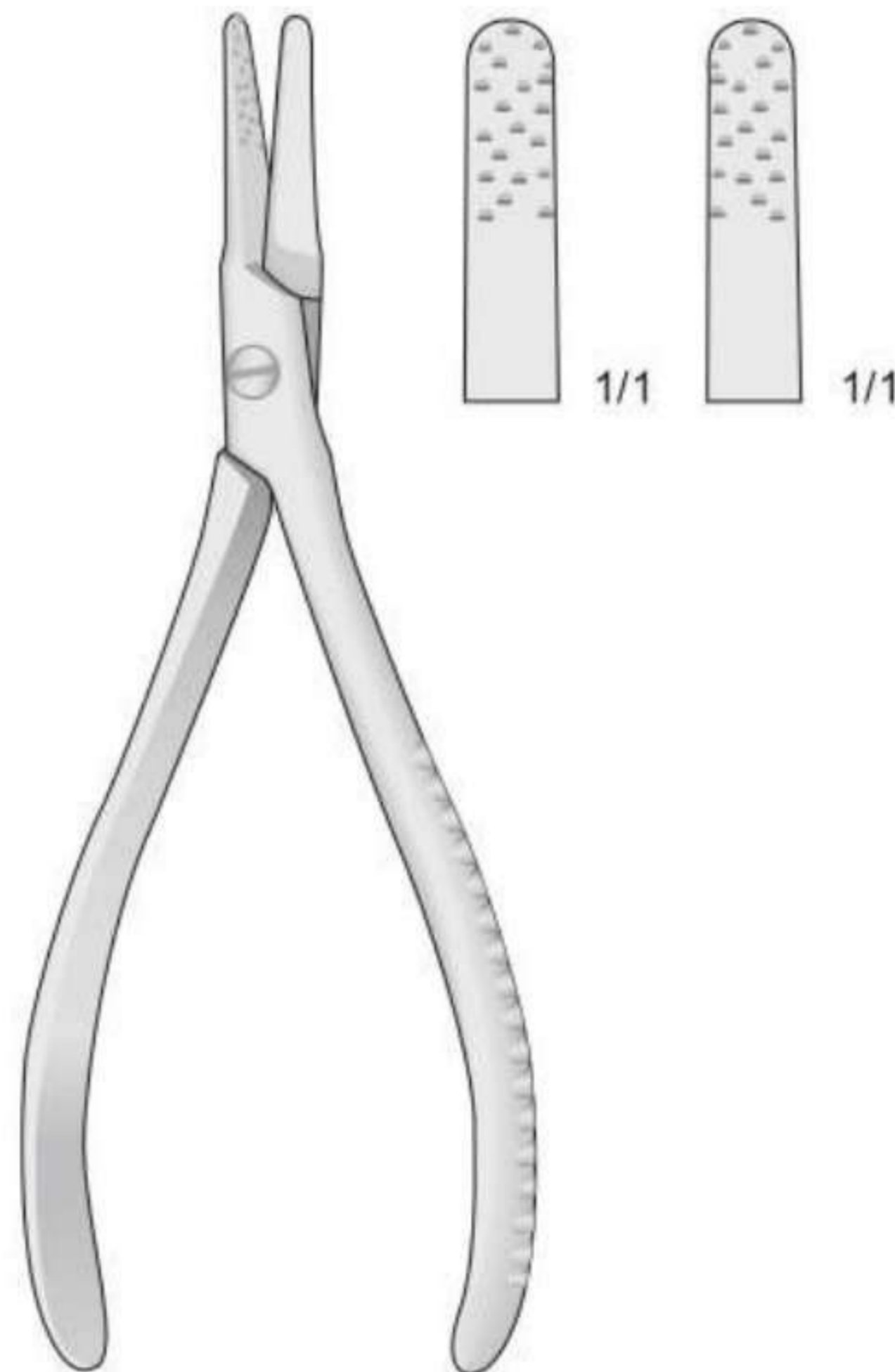

RADOLF
FO-159
135 mm

Nagelspaltzange
Nail nipper
Pinza per unghie
Pinzas corta uñas
Pince à ongles

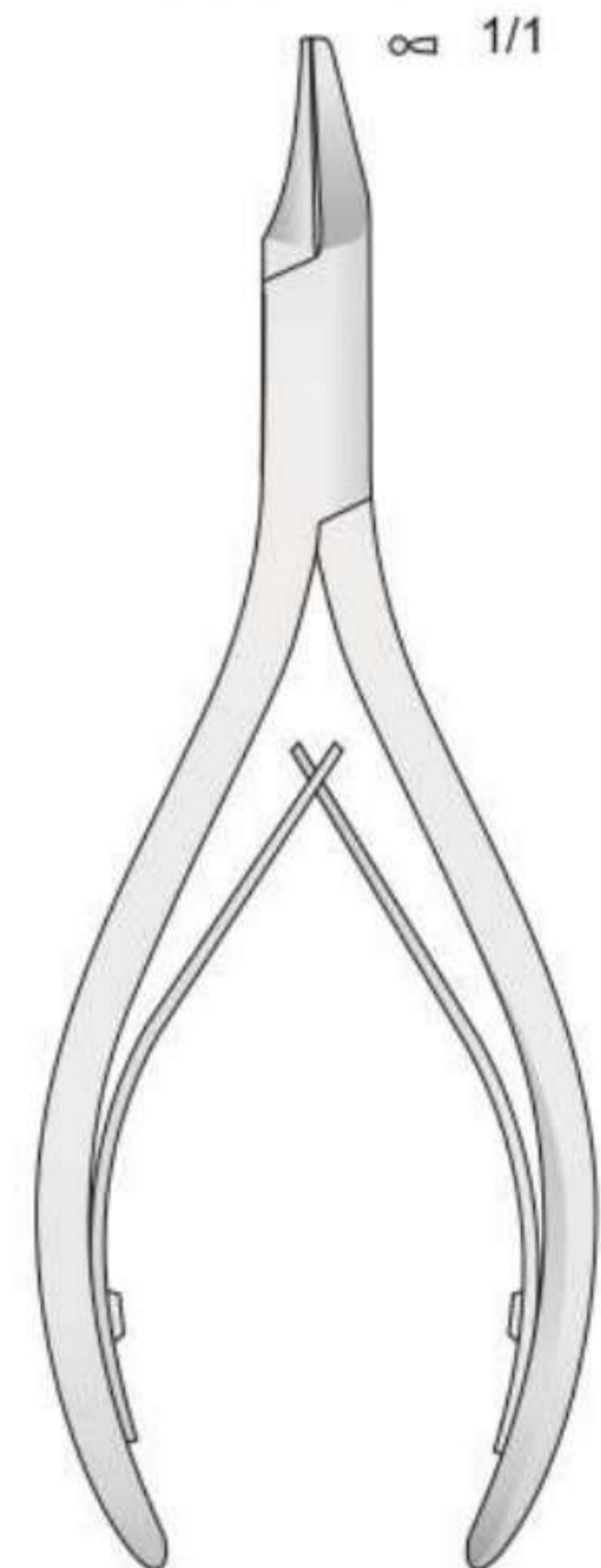

DP-09
135 mm

Hohlmeißelzangen

Bone rongeurs

Pinze ossivore

Pinzas gubias

Pinces gouges

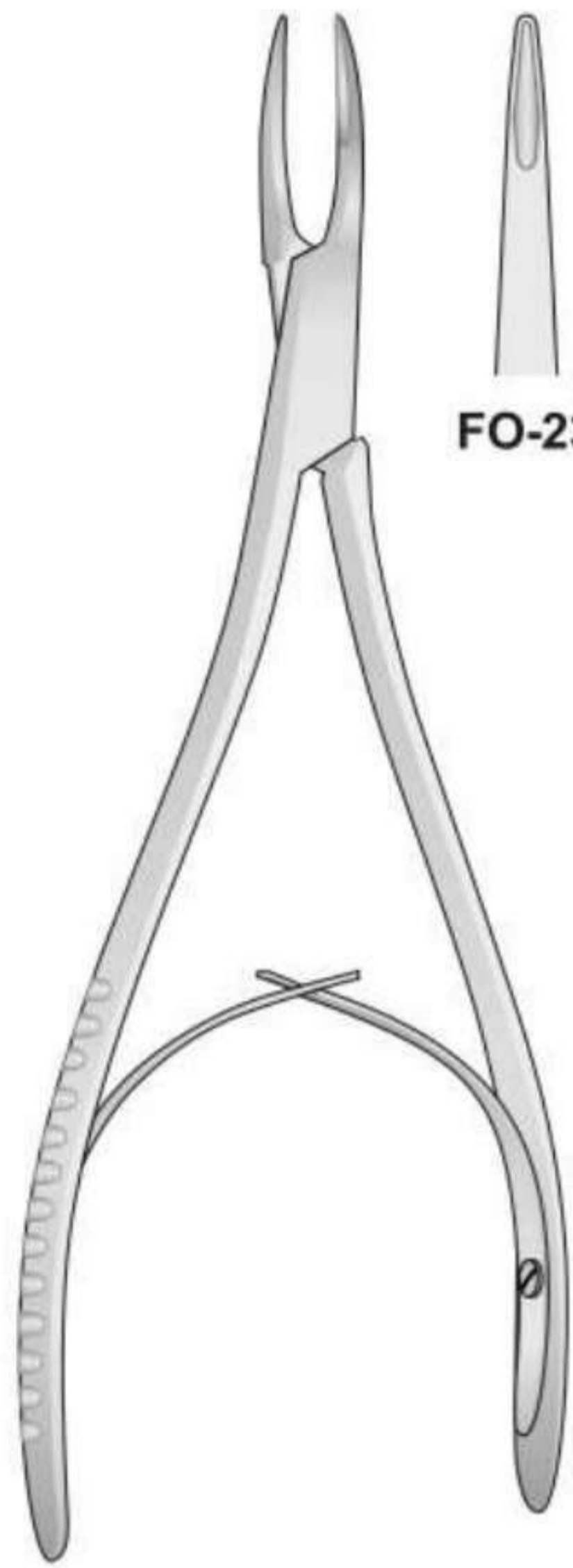

MINI-FRIEDMANN
FO-22/FO-220
150 mm

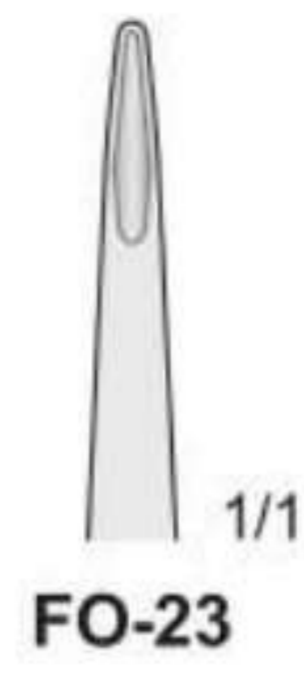

FO-23



FO-22

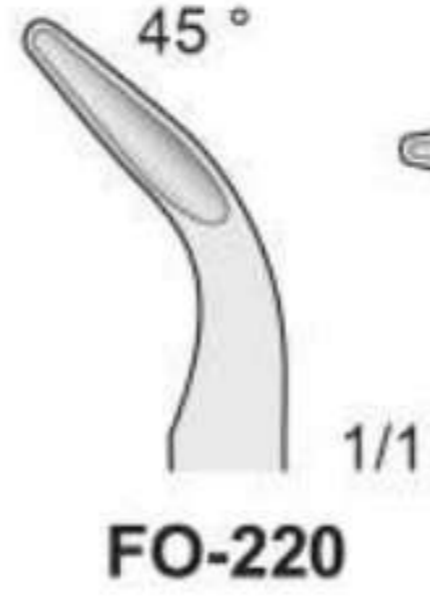

FO-220

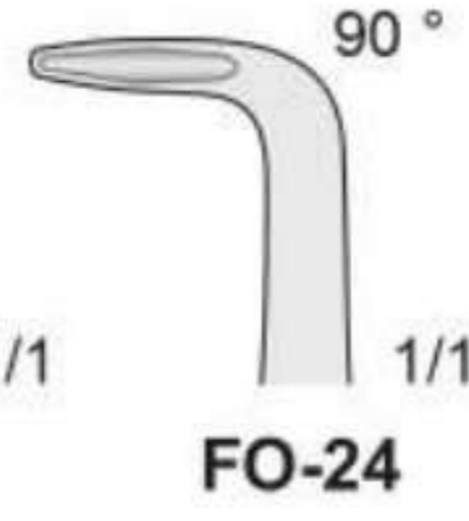

FO-24

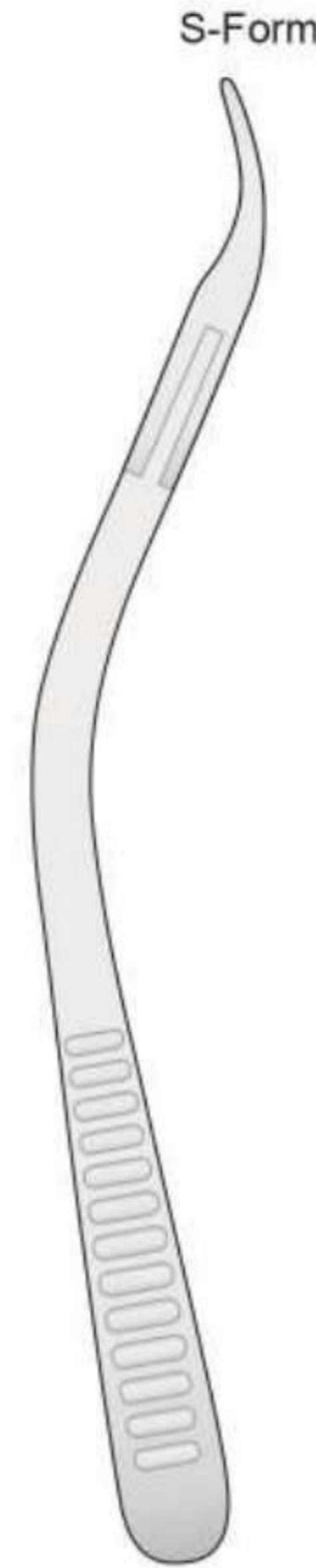

MINI-FRIEDMANN
FO-85
145 mm

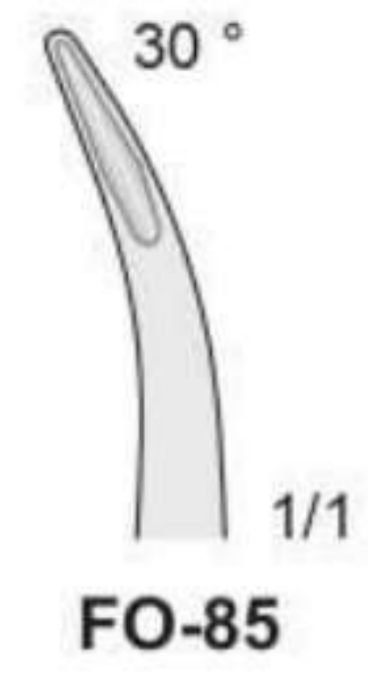

FO-85

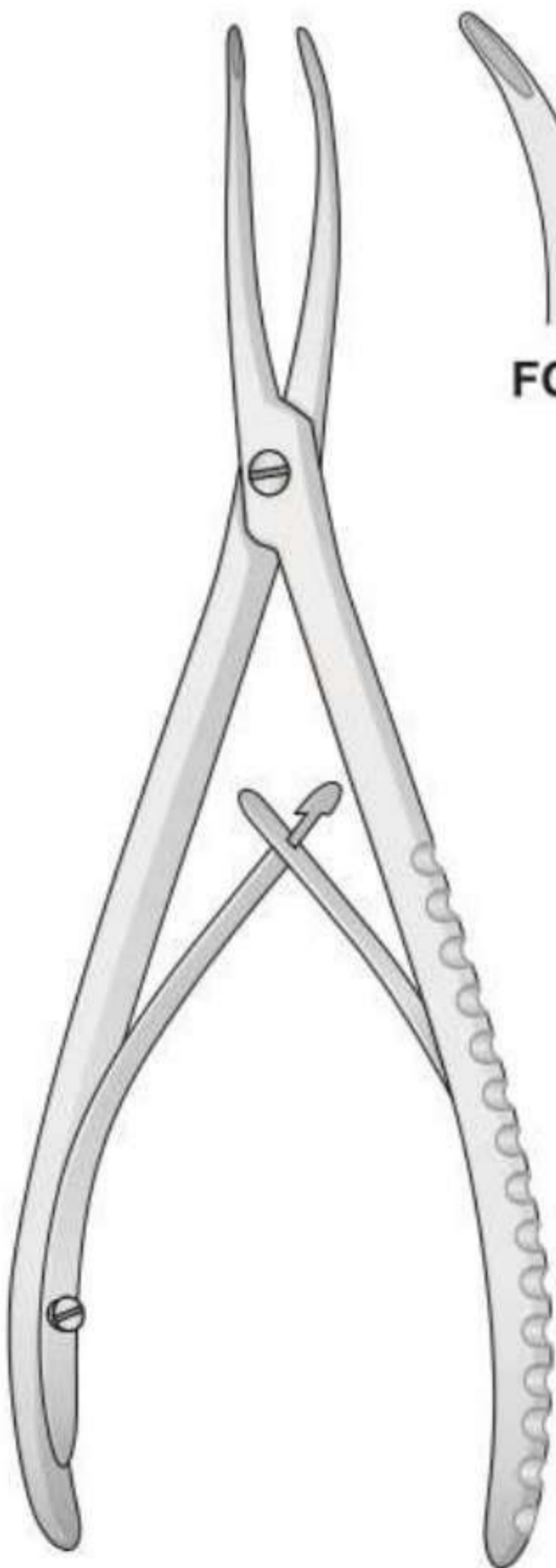

STELLBRINK
FO-88/FO-89
170 mm



FO-88

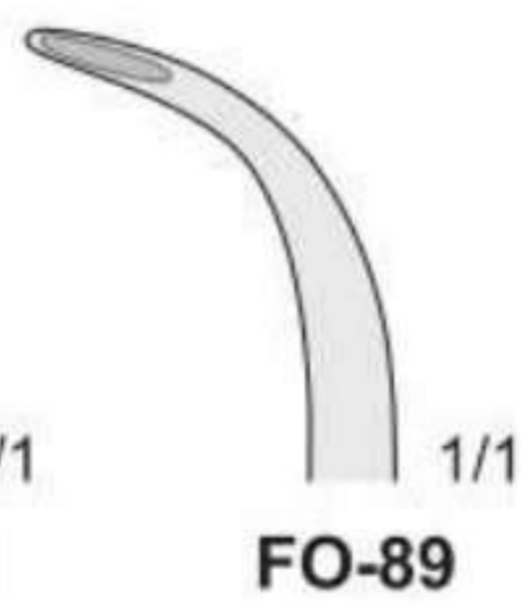

FO-89

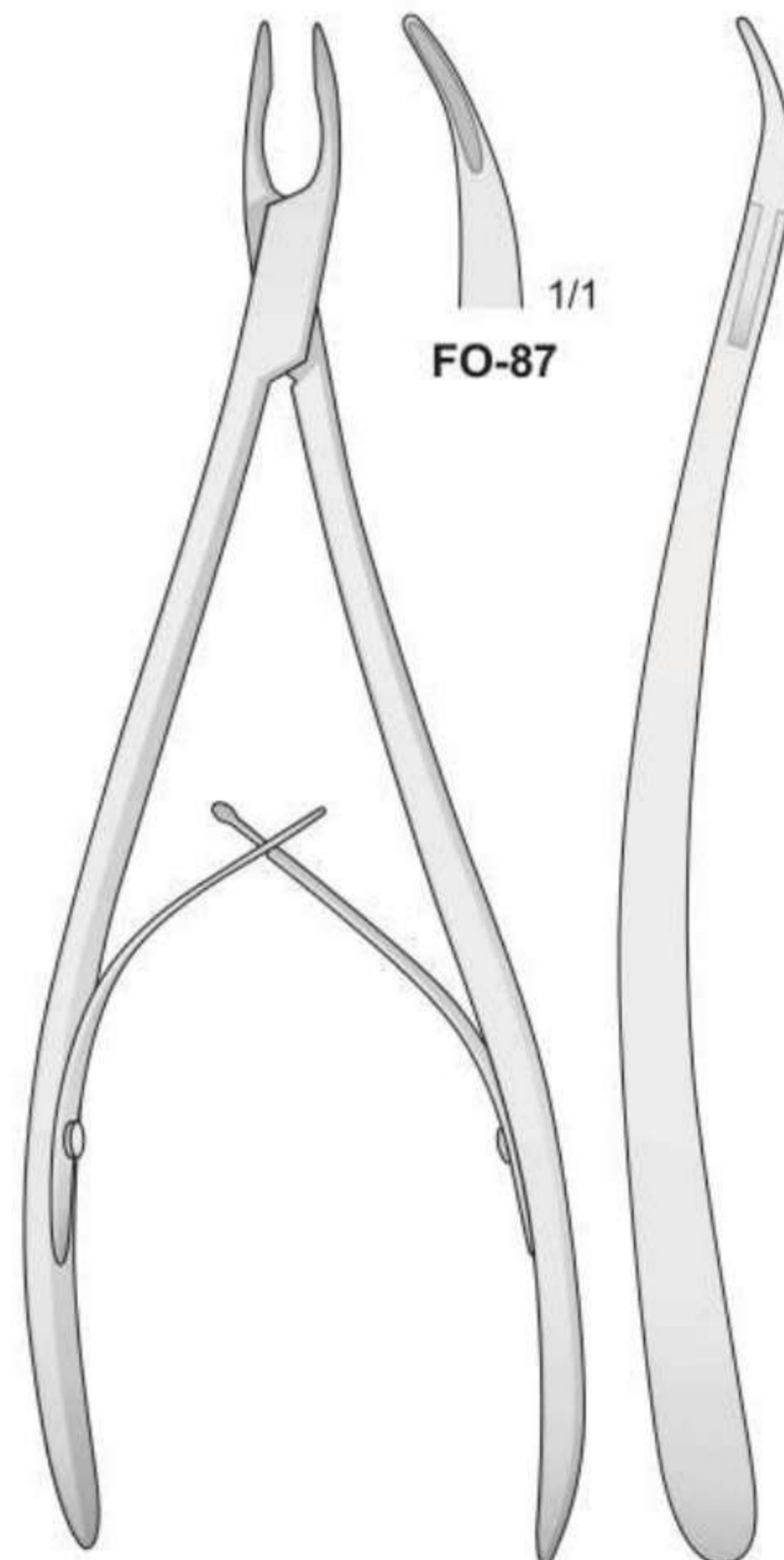

STELLBRINK
FO-87
190 mm

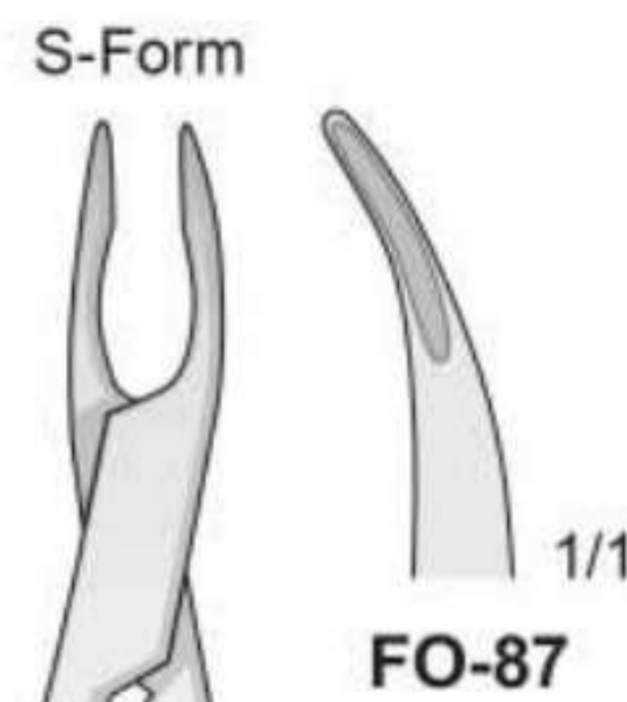

FO-87

Hohlmeißelzangen

Bone rongeurs

Pinze ossivore

Pinza gubias

Pinces gouges

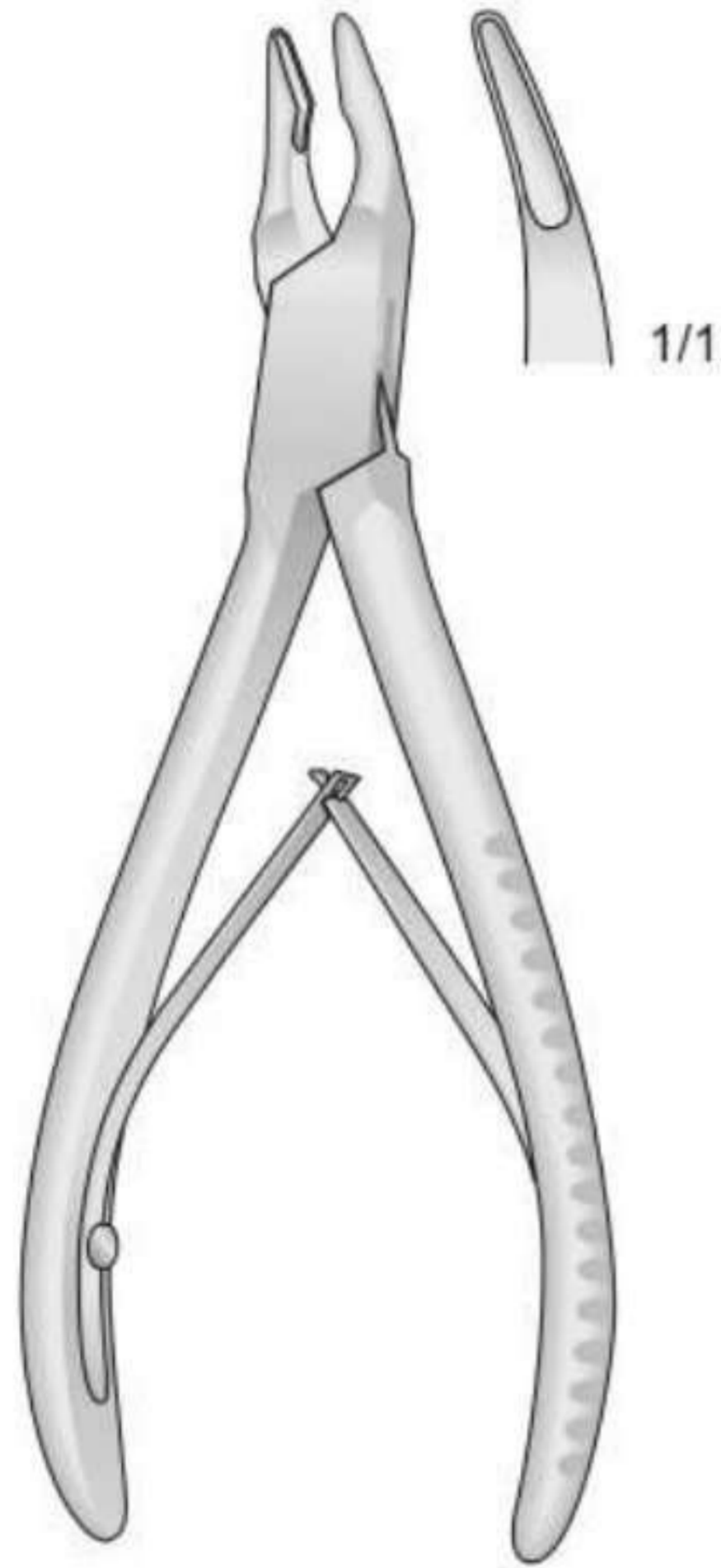

MINI FRIEDMANN
FO-15
120 mm

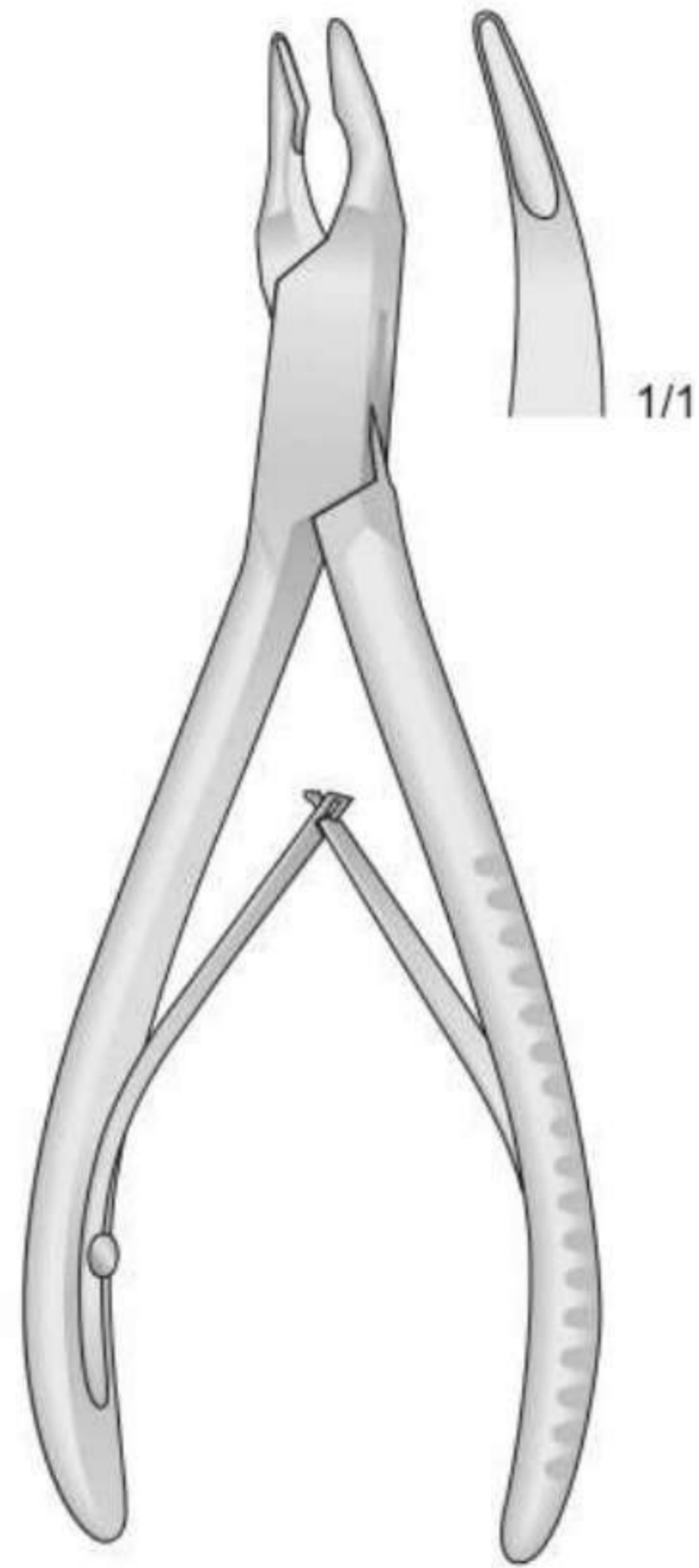

FRIEDMANN
FO-17
140 mm

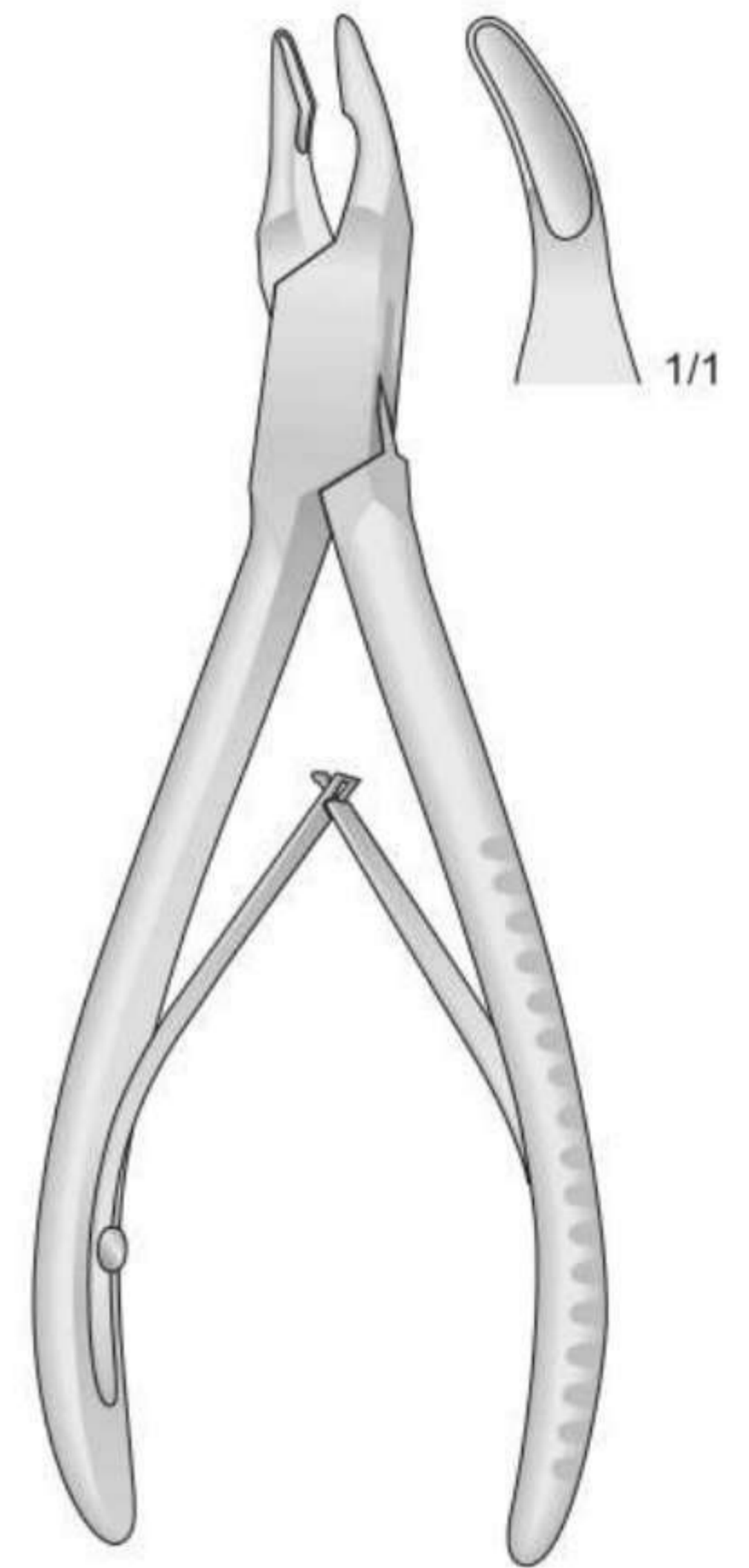

BLUMENTHAL
FO-19
155 mm

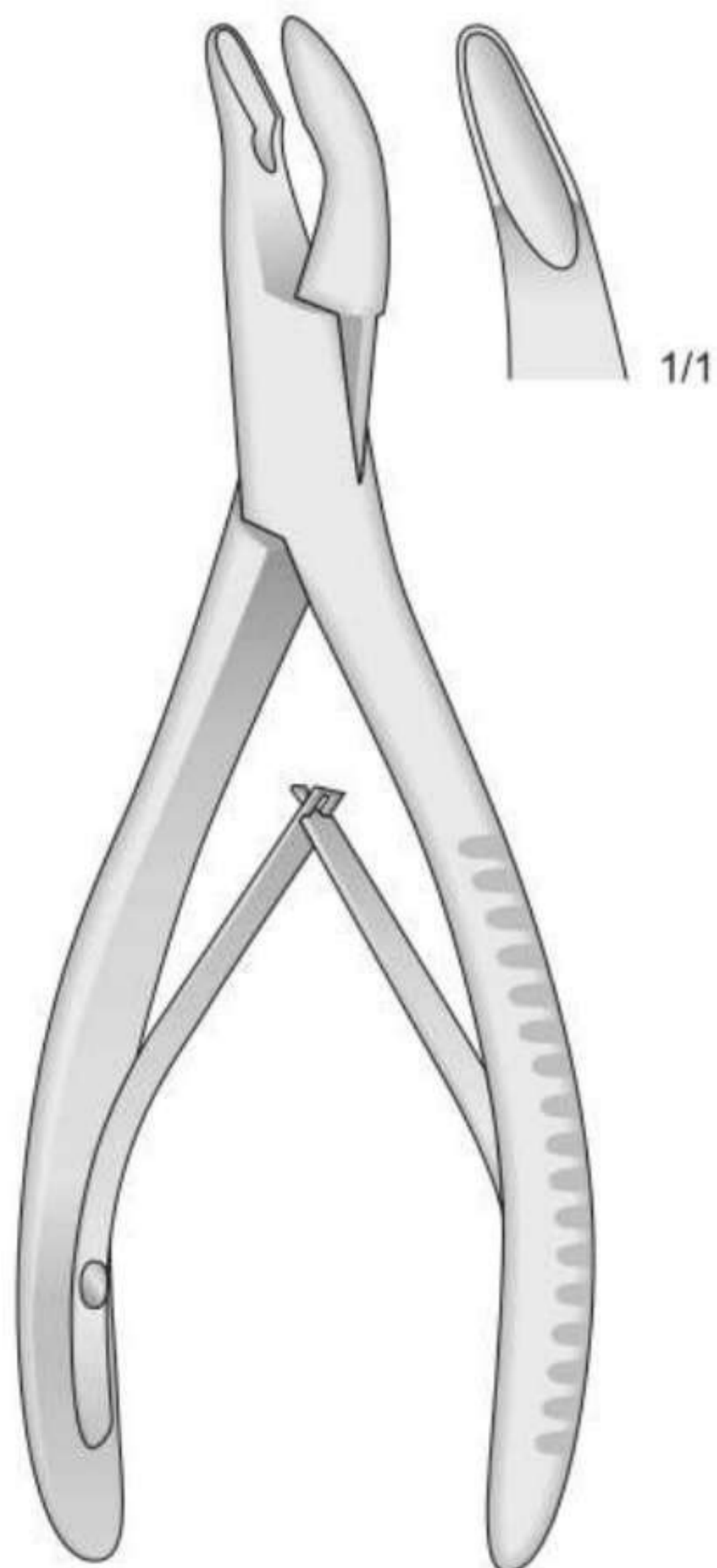

MEAD
FO-21
165 mm

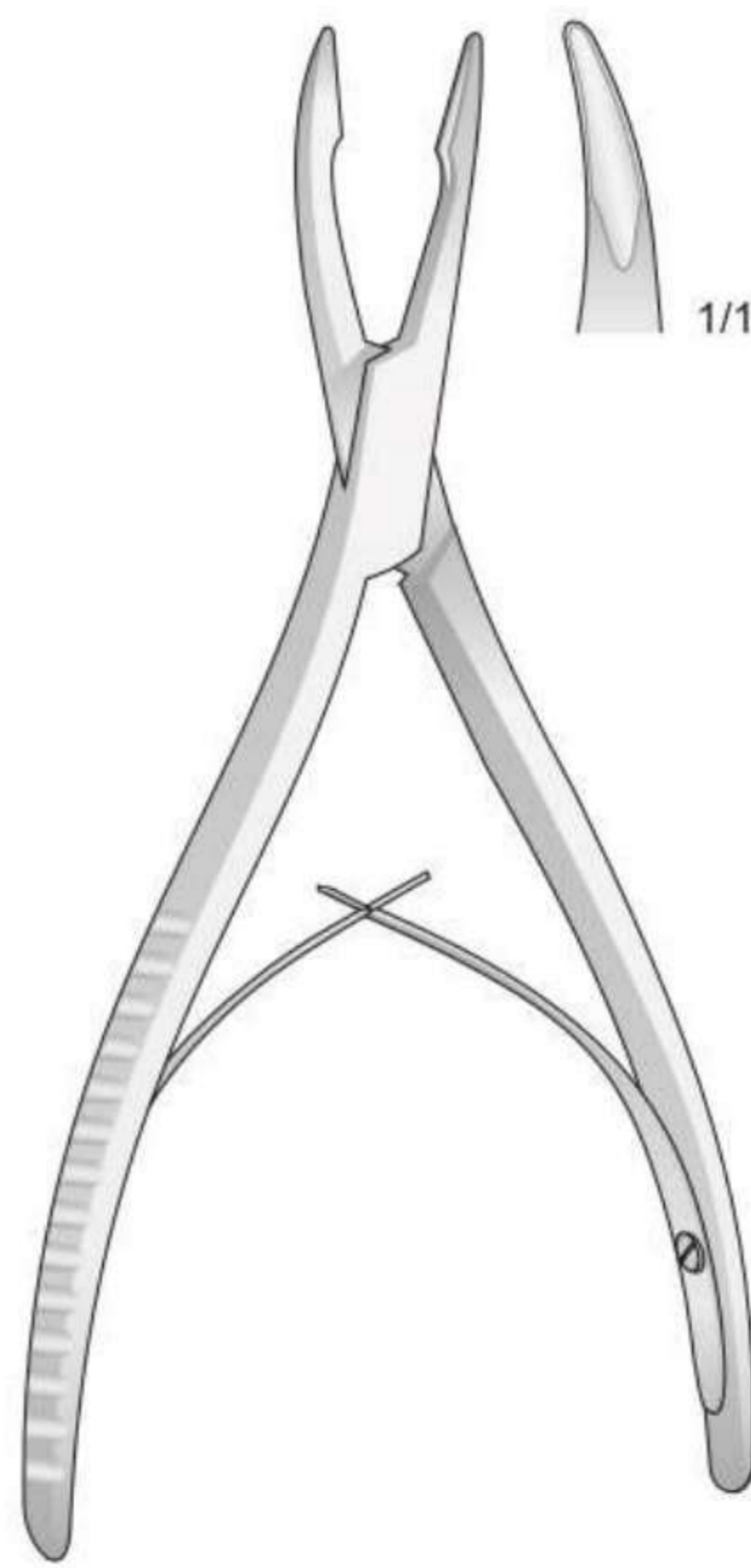

FRIEDMANN
FO-16
160 mm

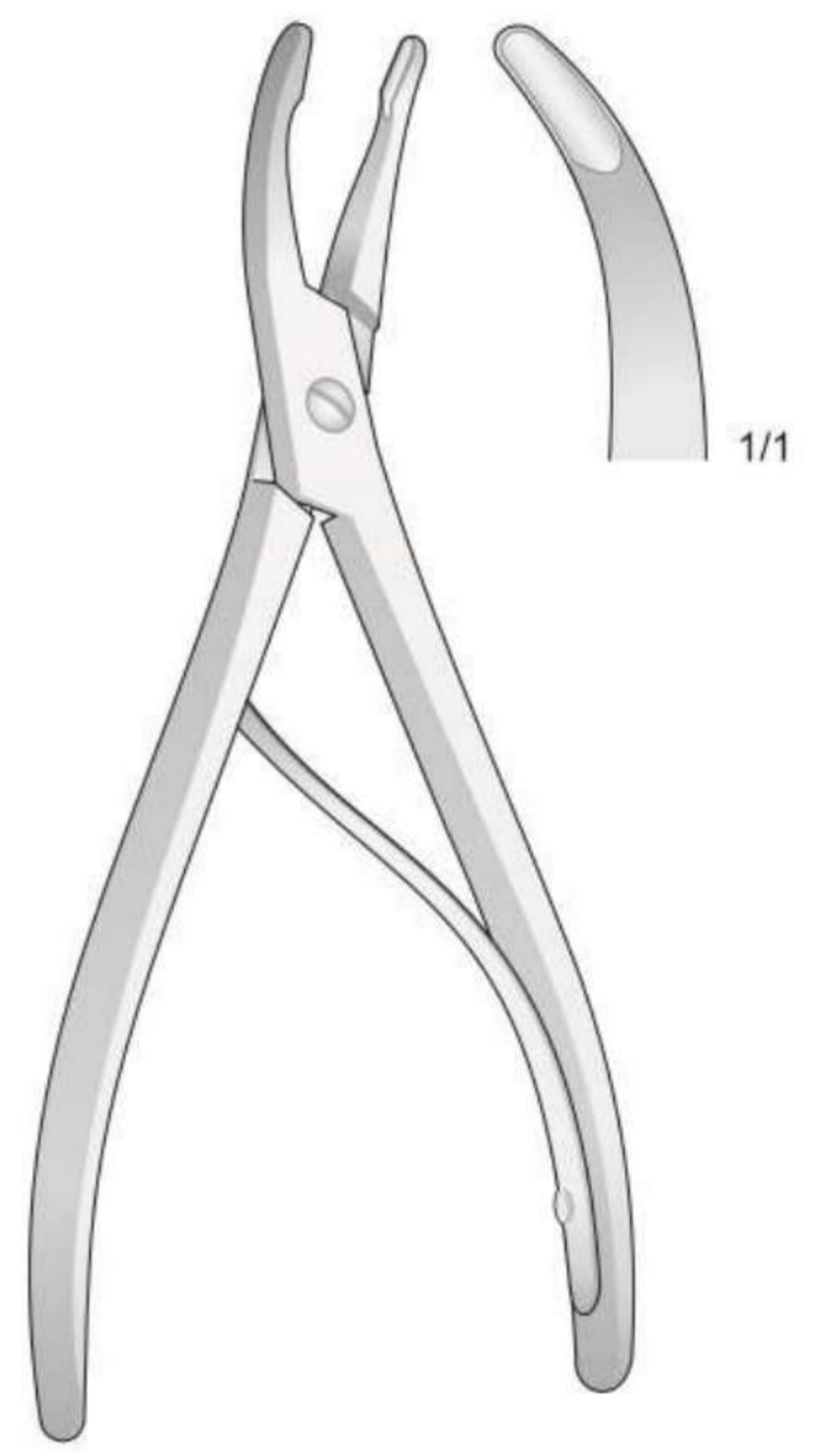

LUER
FO-18
155 mm

Hohlmeißelzangen

Bone rongeurs

Pinze ossivore

Pinza gubias

Pinces gouges

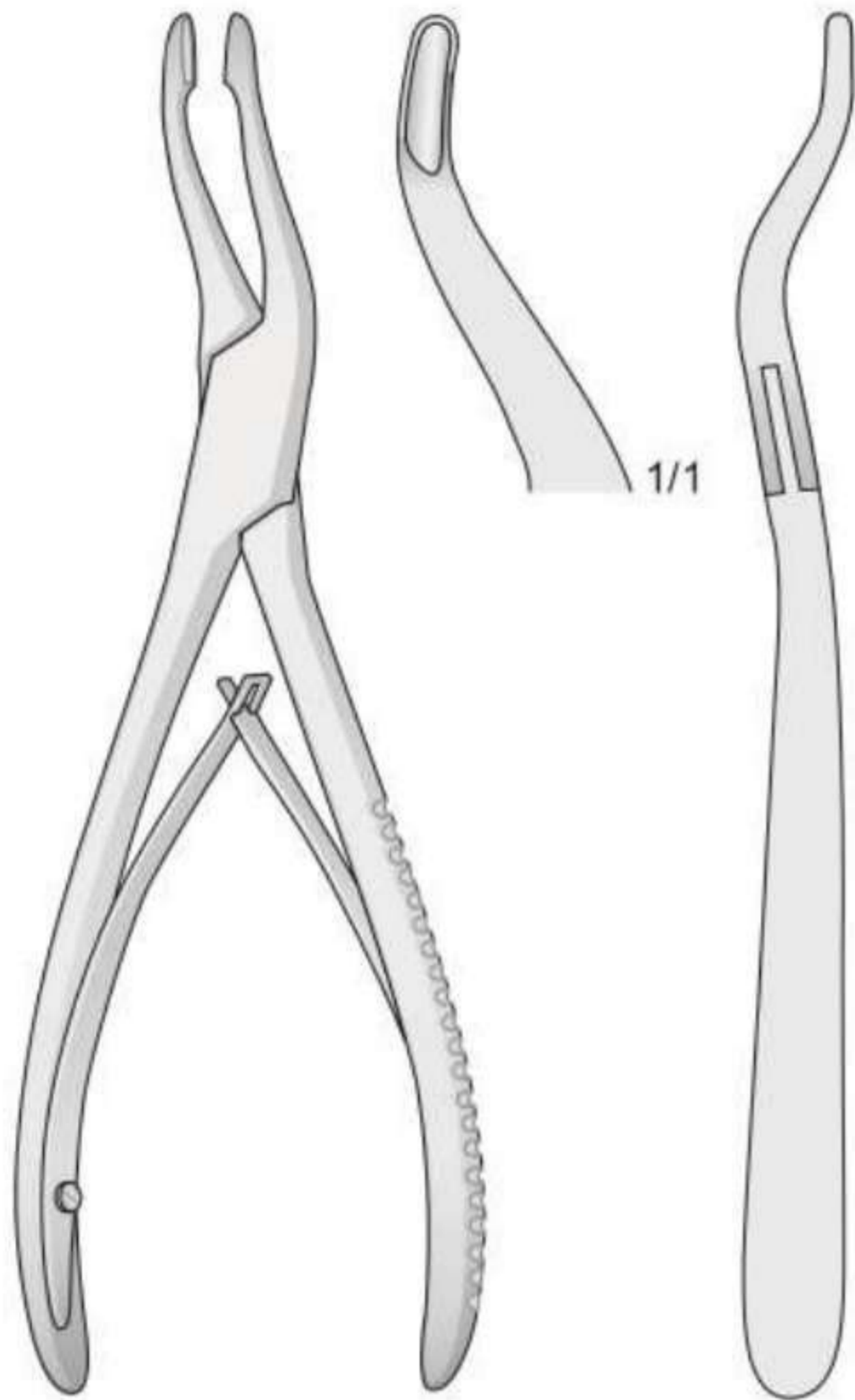

ALEXANDER
FO-27
140 mm

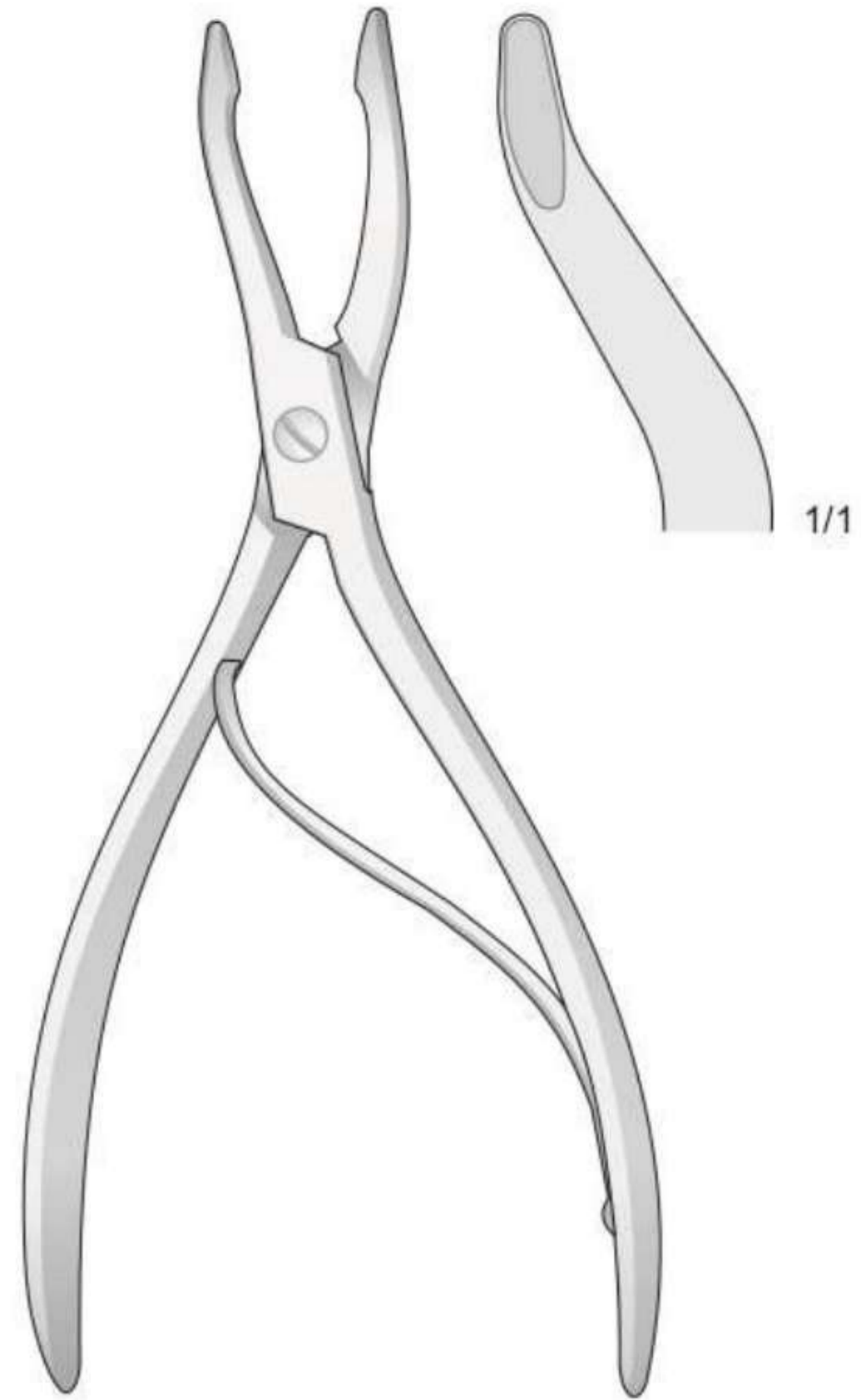

JANSEN-LEUER
FO-10
180 mm

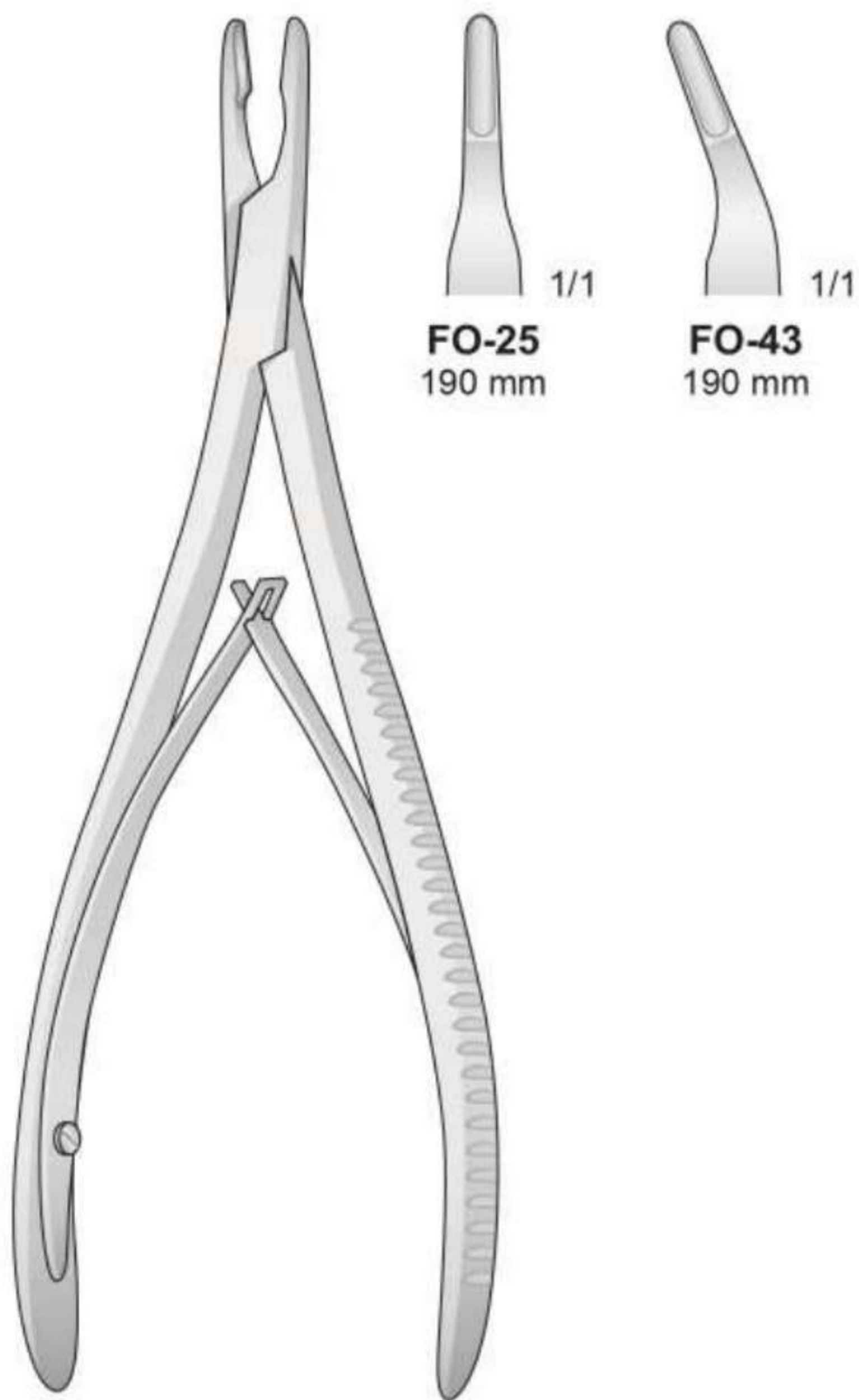

LEMPERT
FO-25/FO-43
190 mm

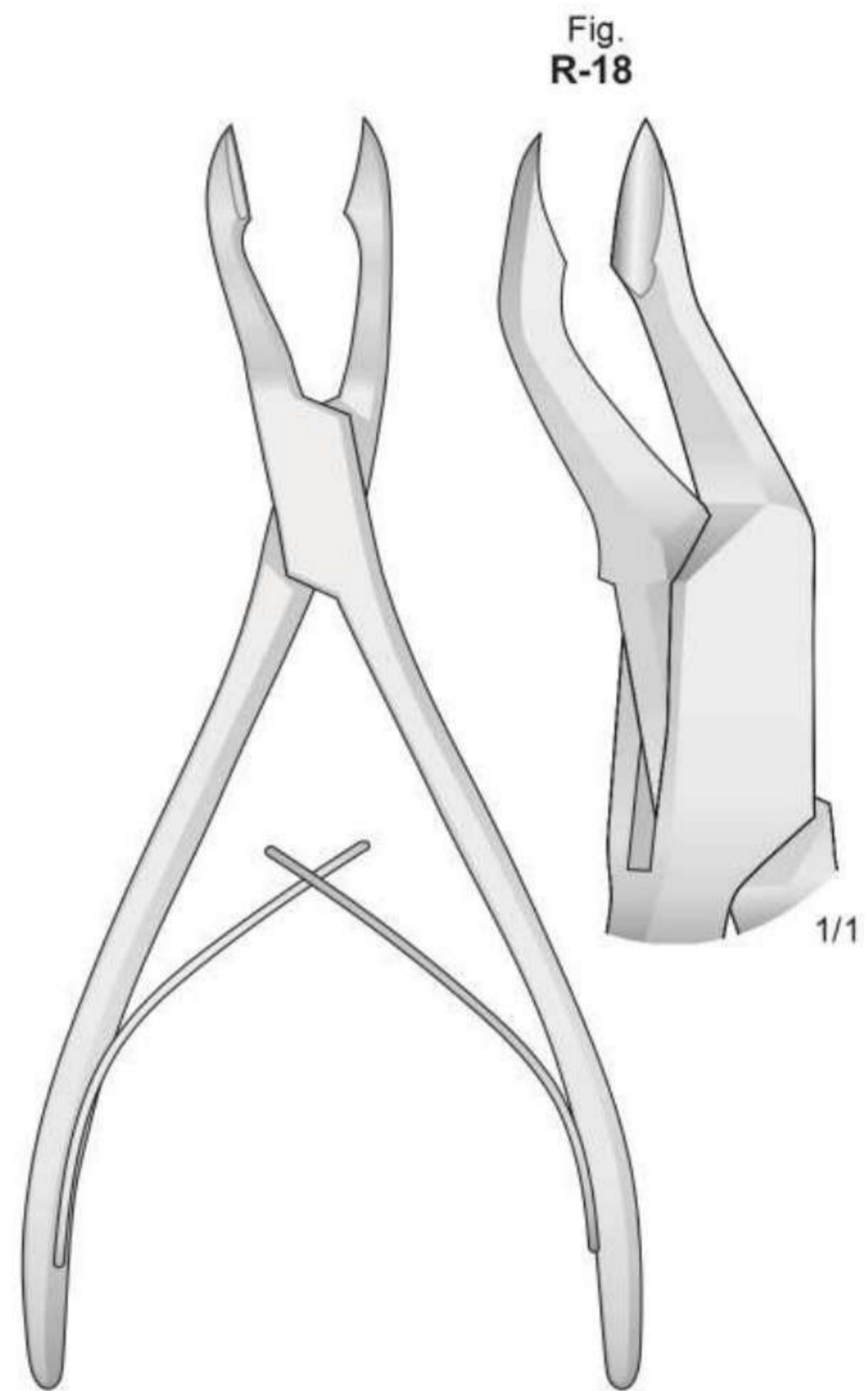

FO-33
175 mm

Hohlmeißelzangen

Bone rongeurs

Pinze ossivore

Pinza gubias

Pinces gouges

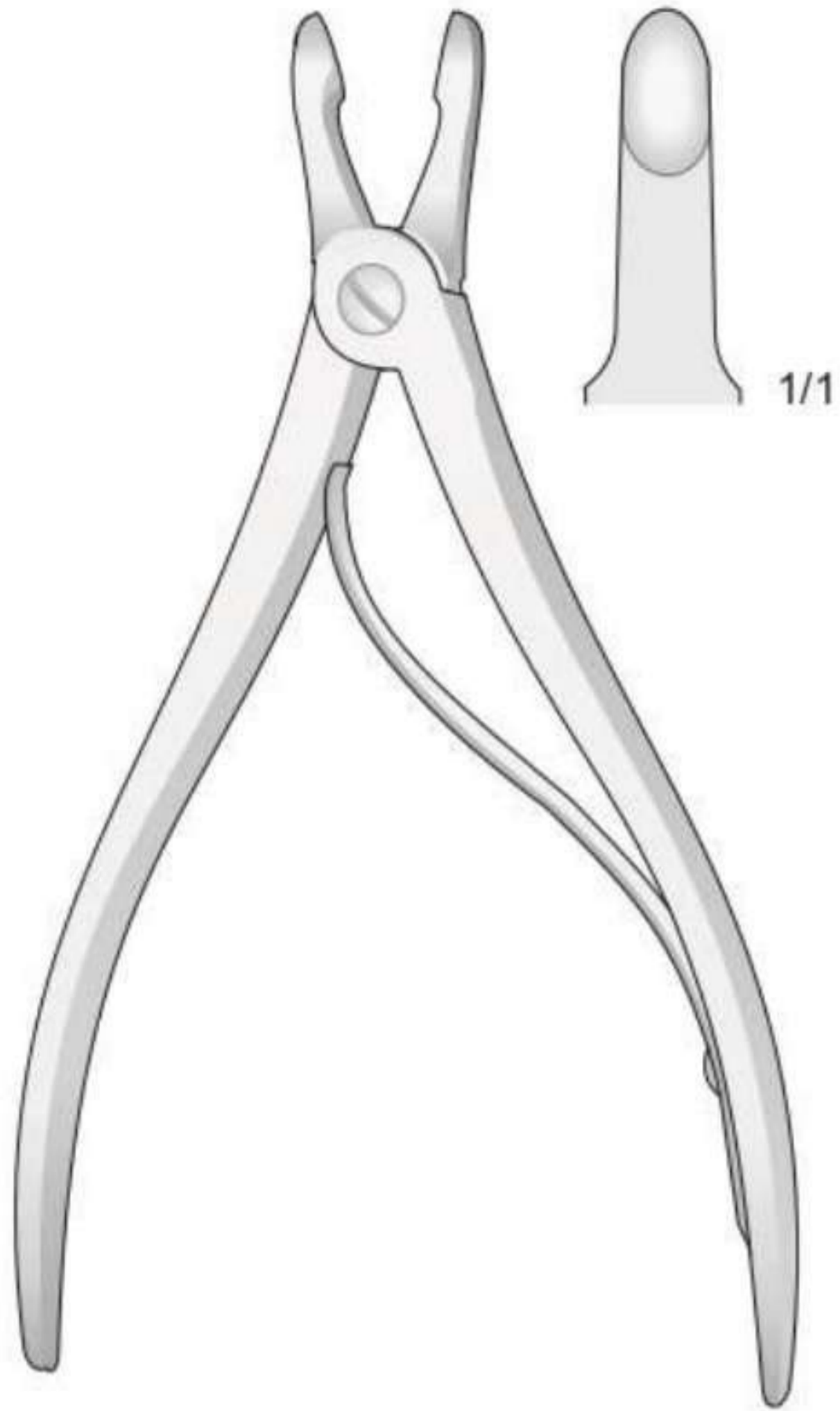

HARTMANN
FO-14
155 mm

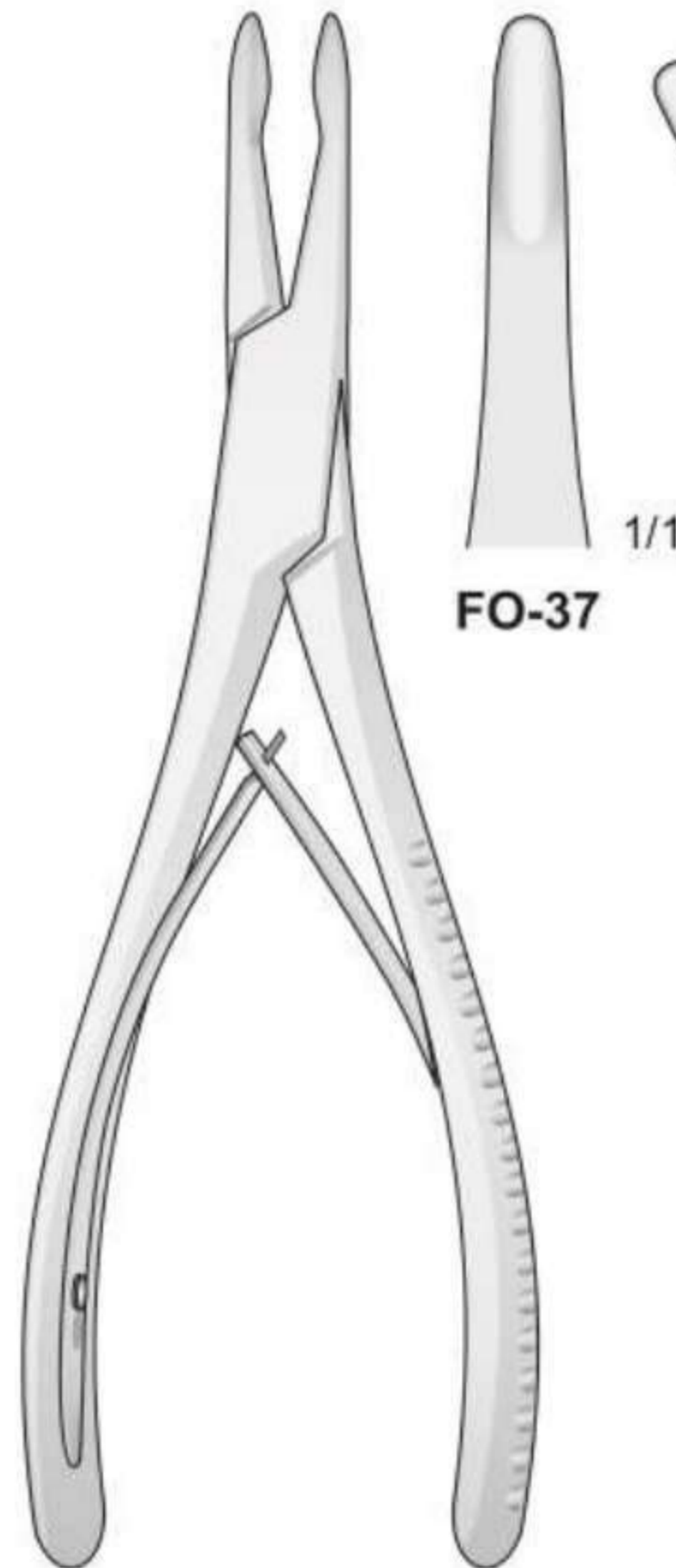

JANSEN
FO-37/FO-39
170 mm

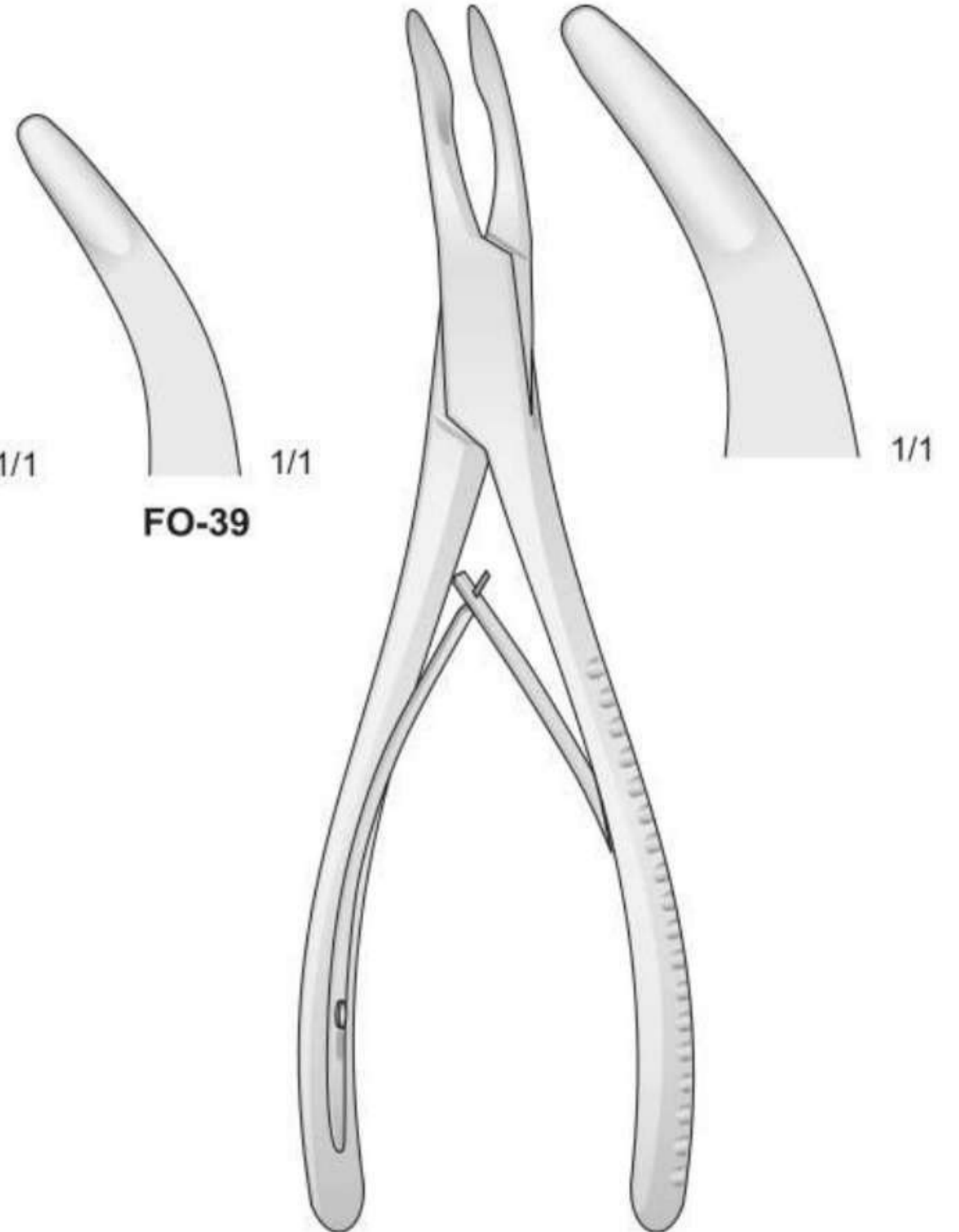

OLIVECRONA
FO-45
190 mm

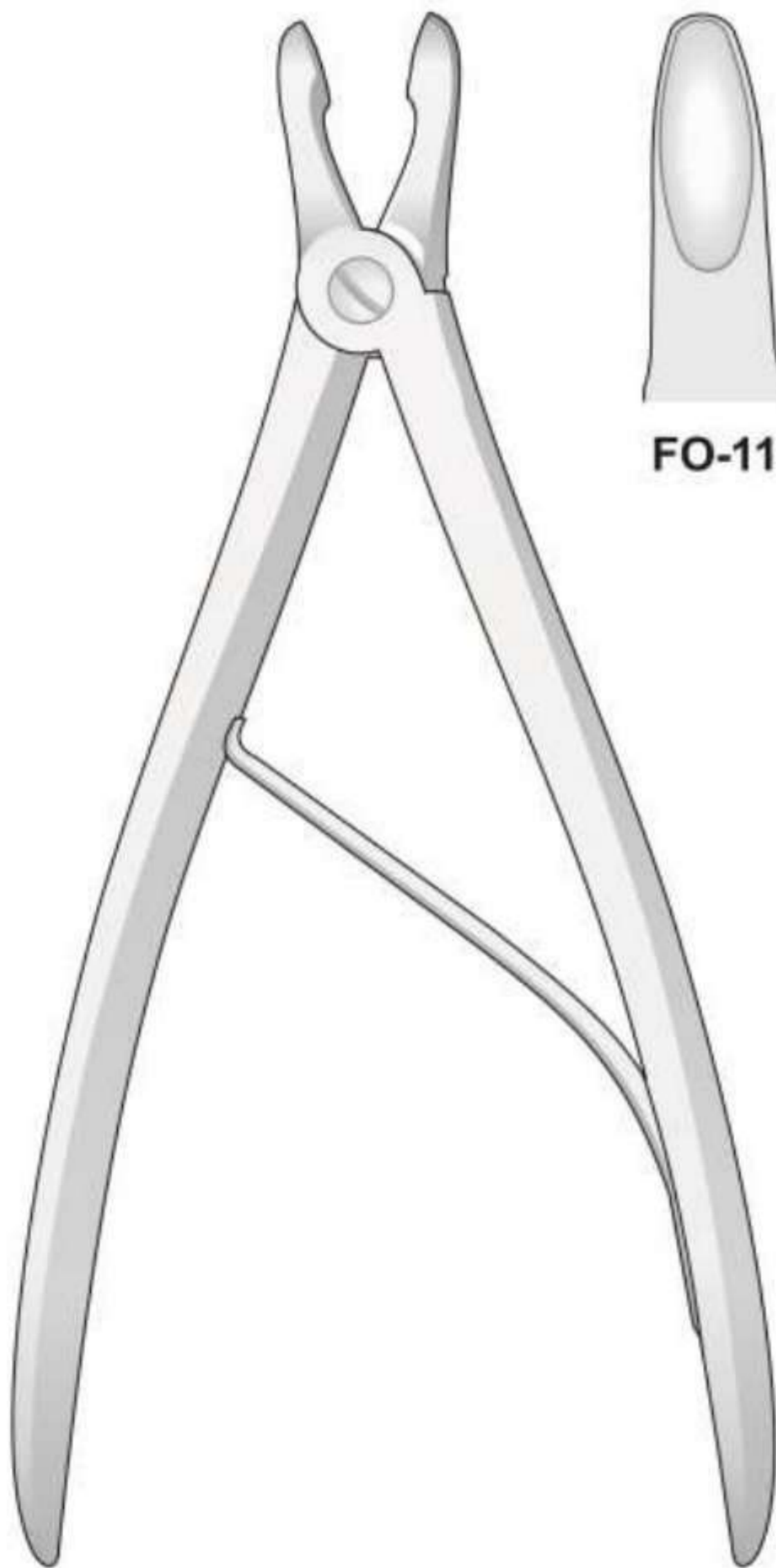

CUSHING
FO-11/FO-12
190 mm

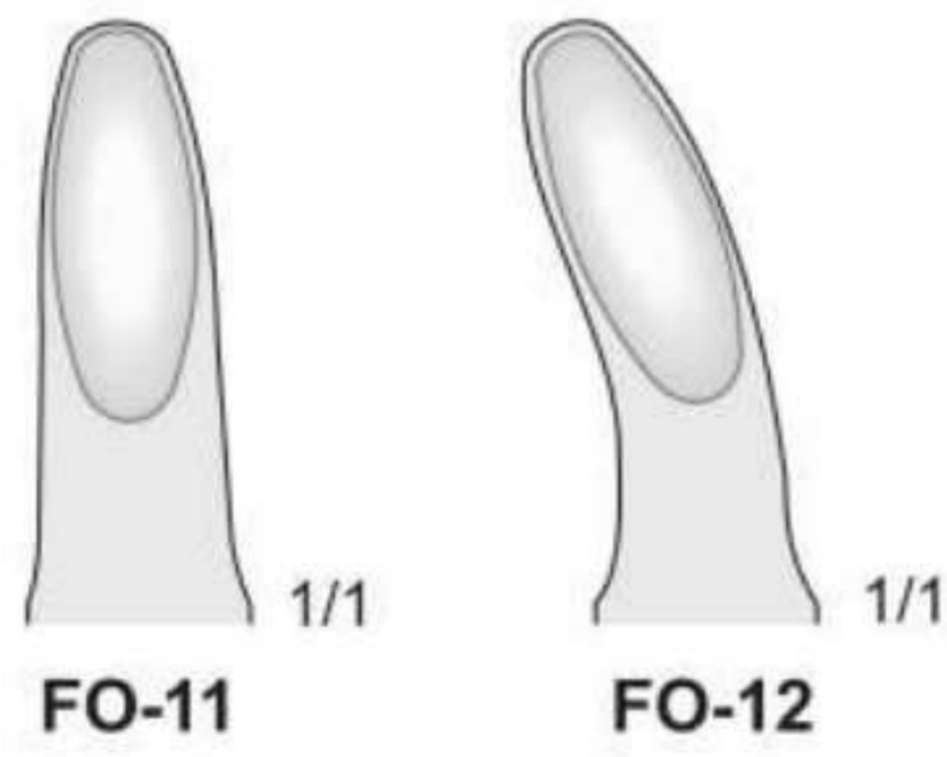

FO-11

FO-12

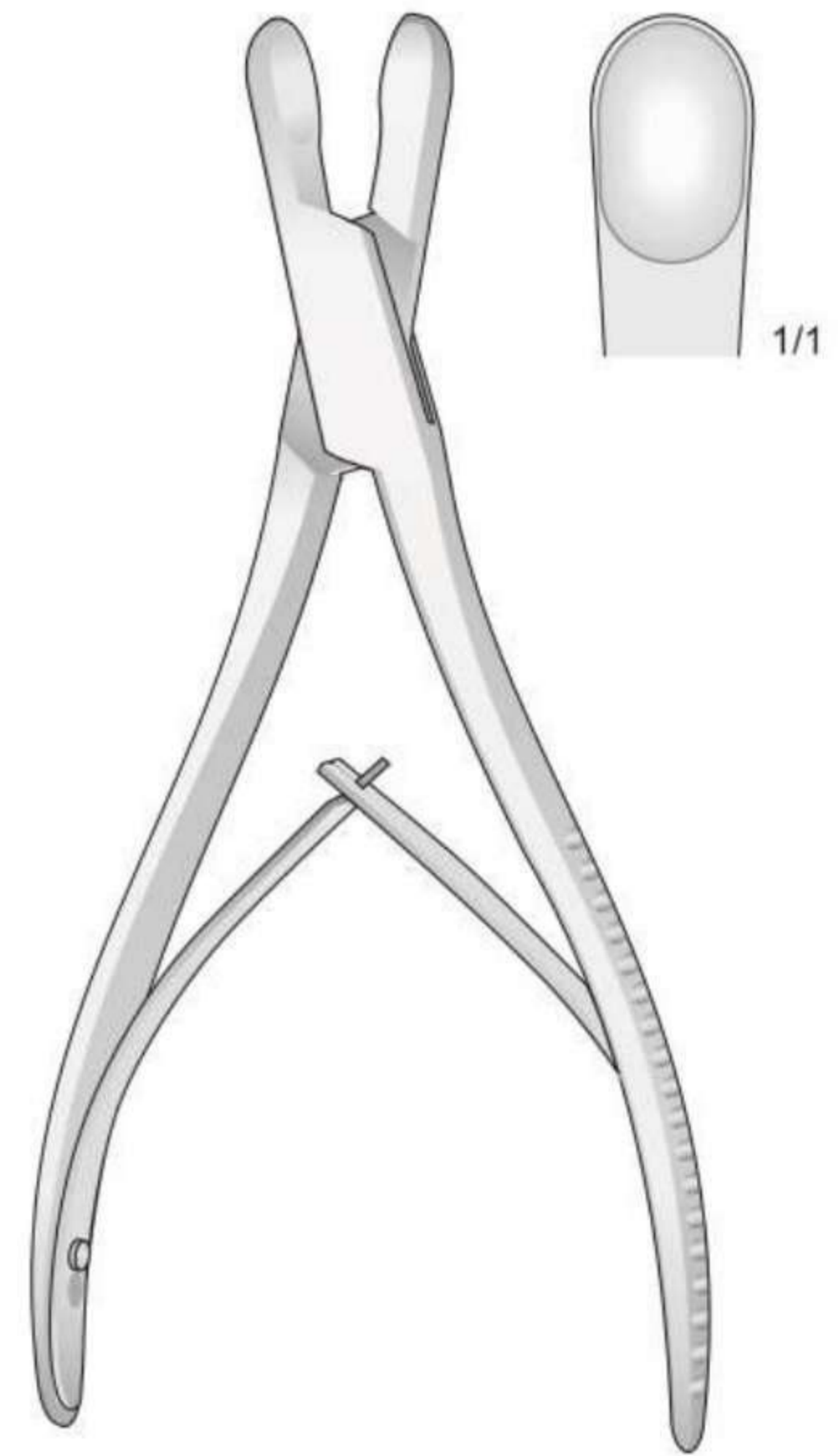

LUER-STILLE
FO-13
185 mm

Hohlmeißelzangen

Bone rongeurs

Pinze ossivore

Pinza gubias

Pinces gouges

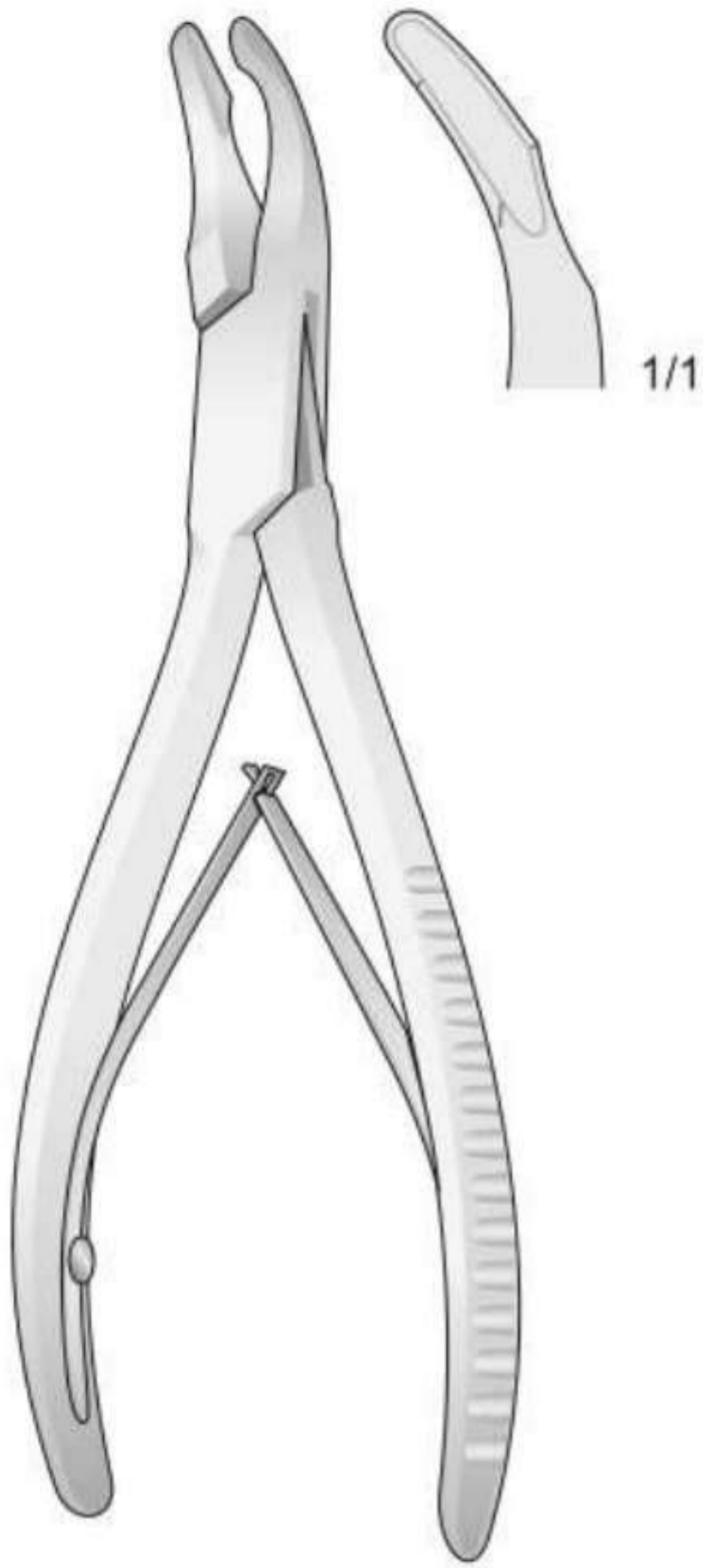

CLEVELAND
FO-231 140 mm
FO-232 170 mm

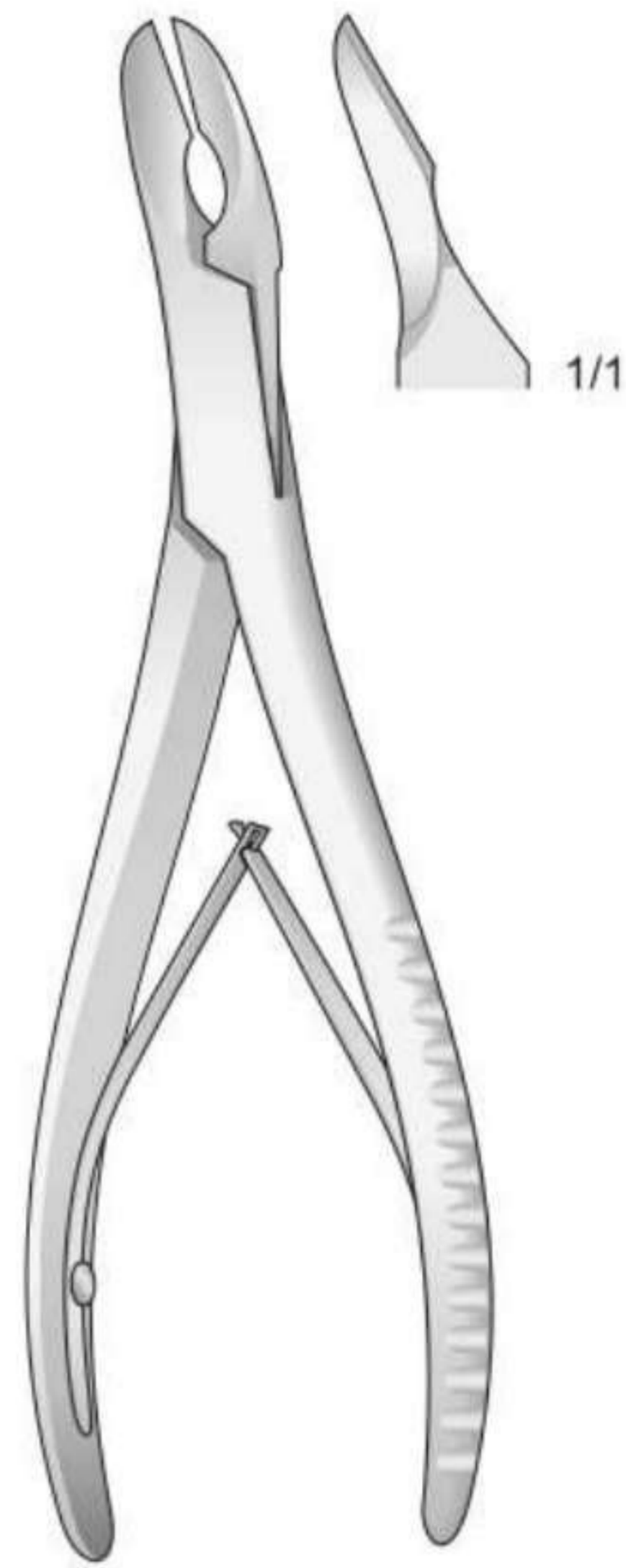

CLEVELAND
FO-233 150 mm
FO-234 170 mm

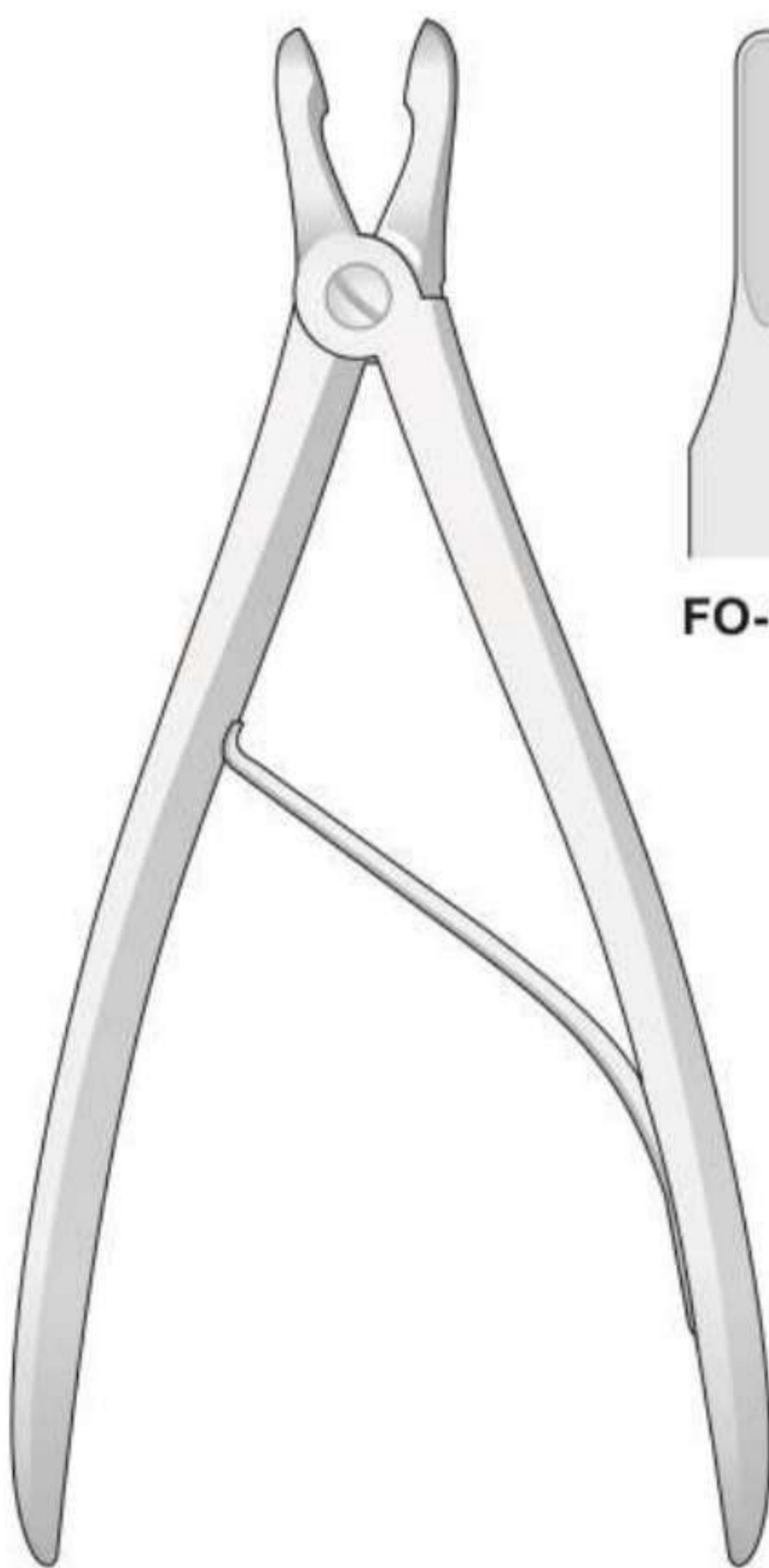

CUSHING
FO-107/FO-109
 190 mm

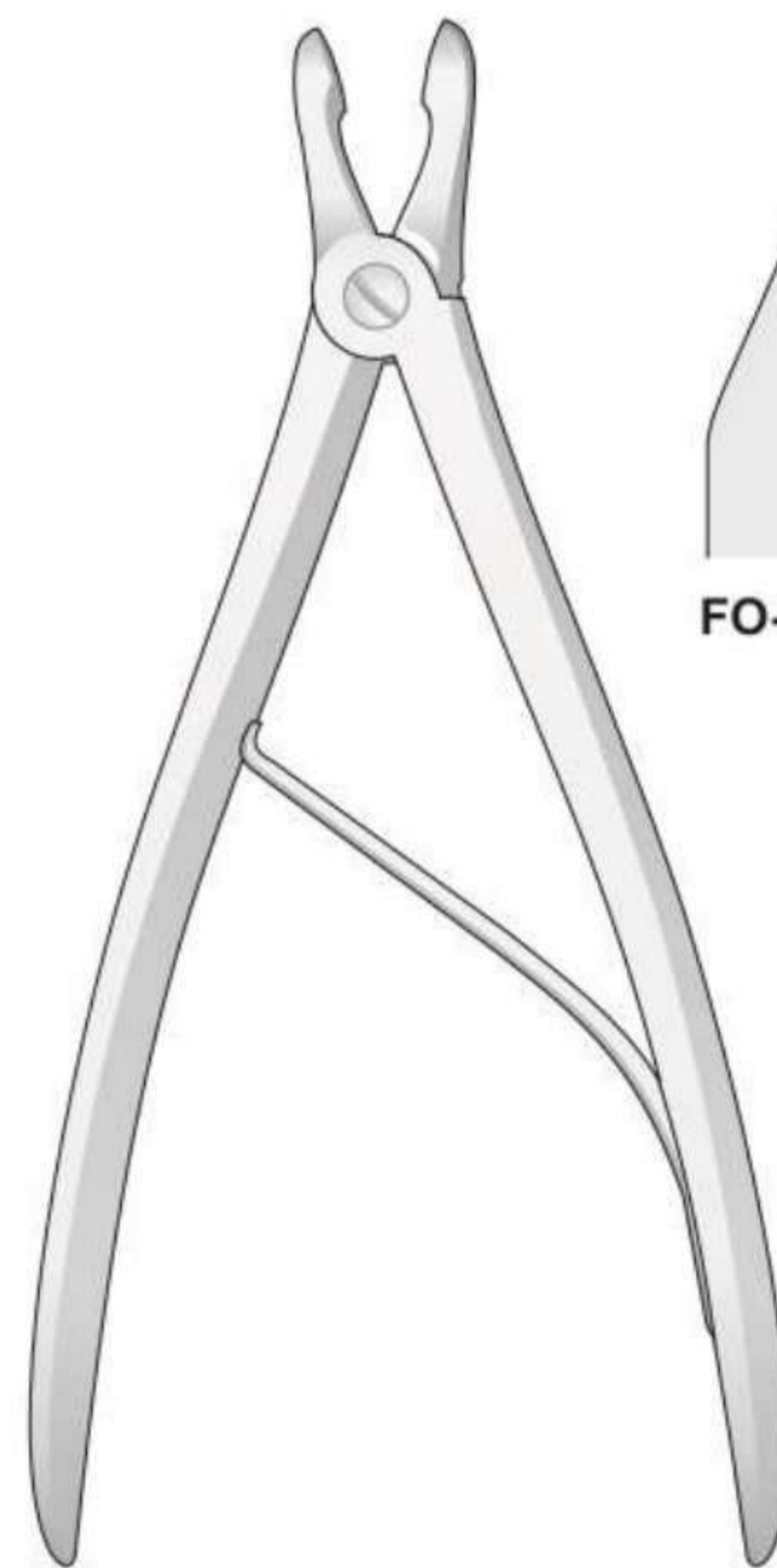
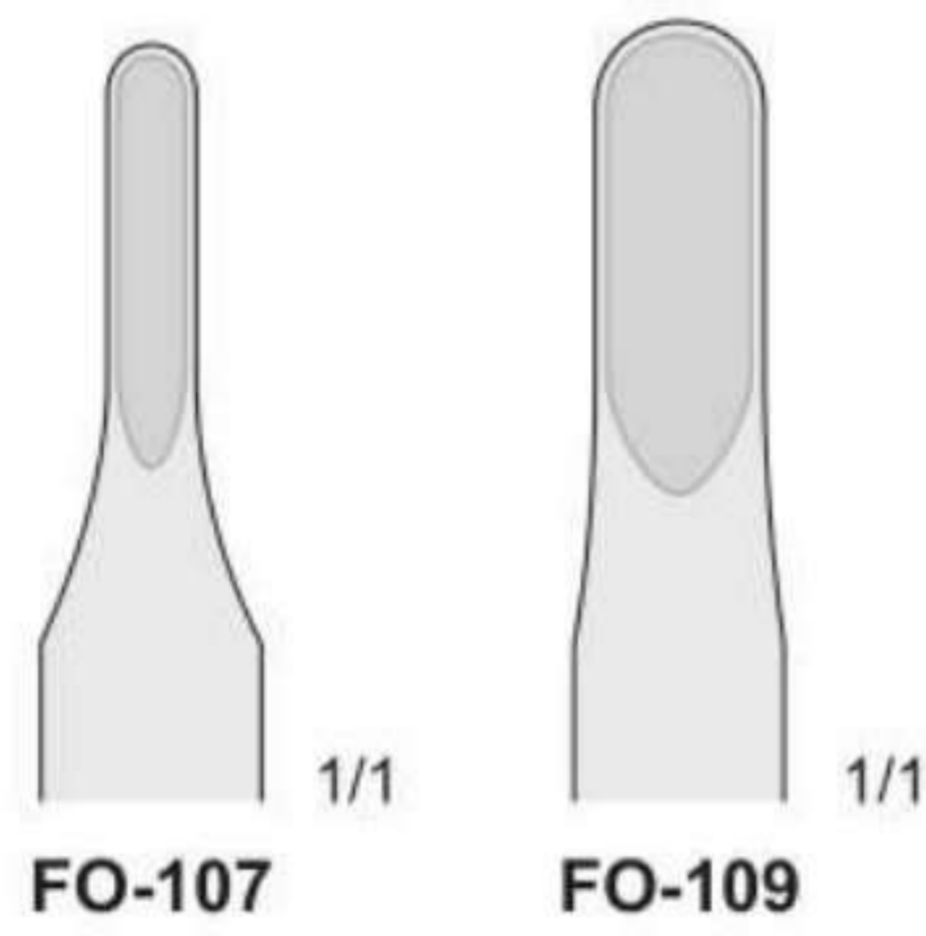

CUSHING
FO-147/FO-149
 190 mm

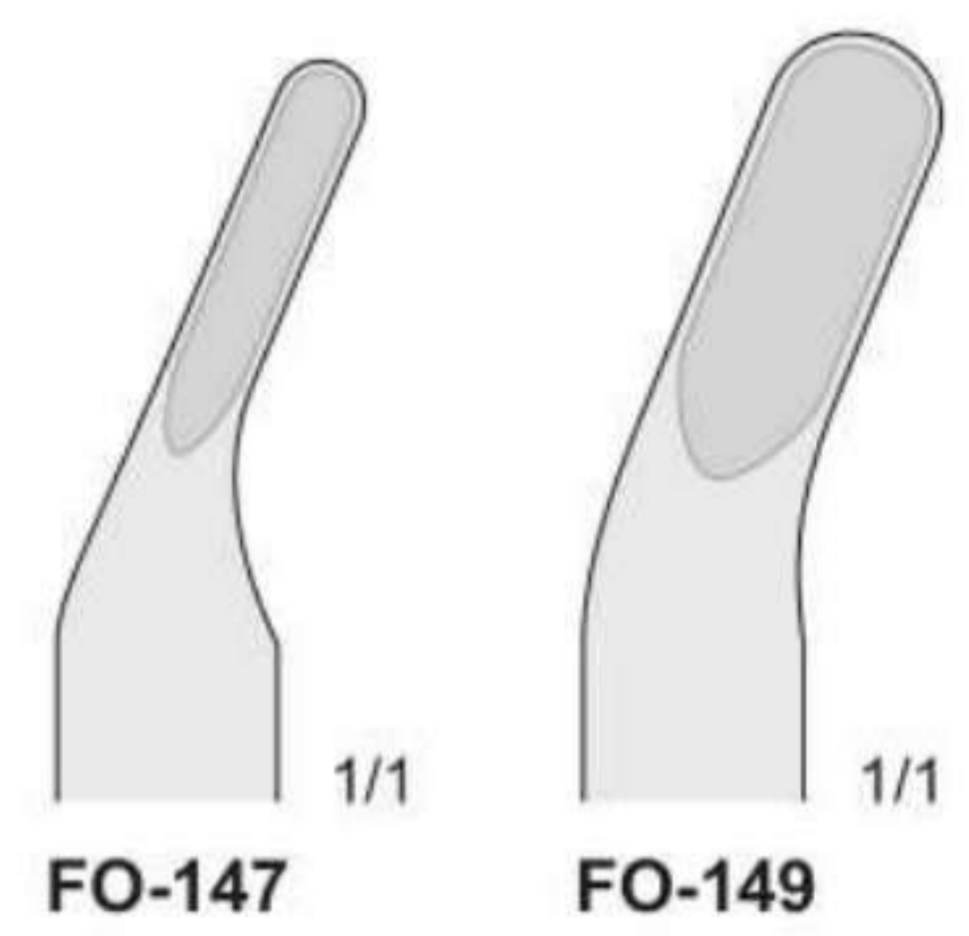

Hohlmeißelzangen

Bone rongeurs

Pinze ossivore

Pinza gubias

Pinces gouges

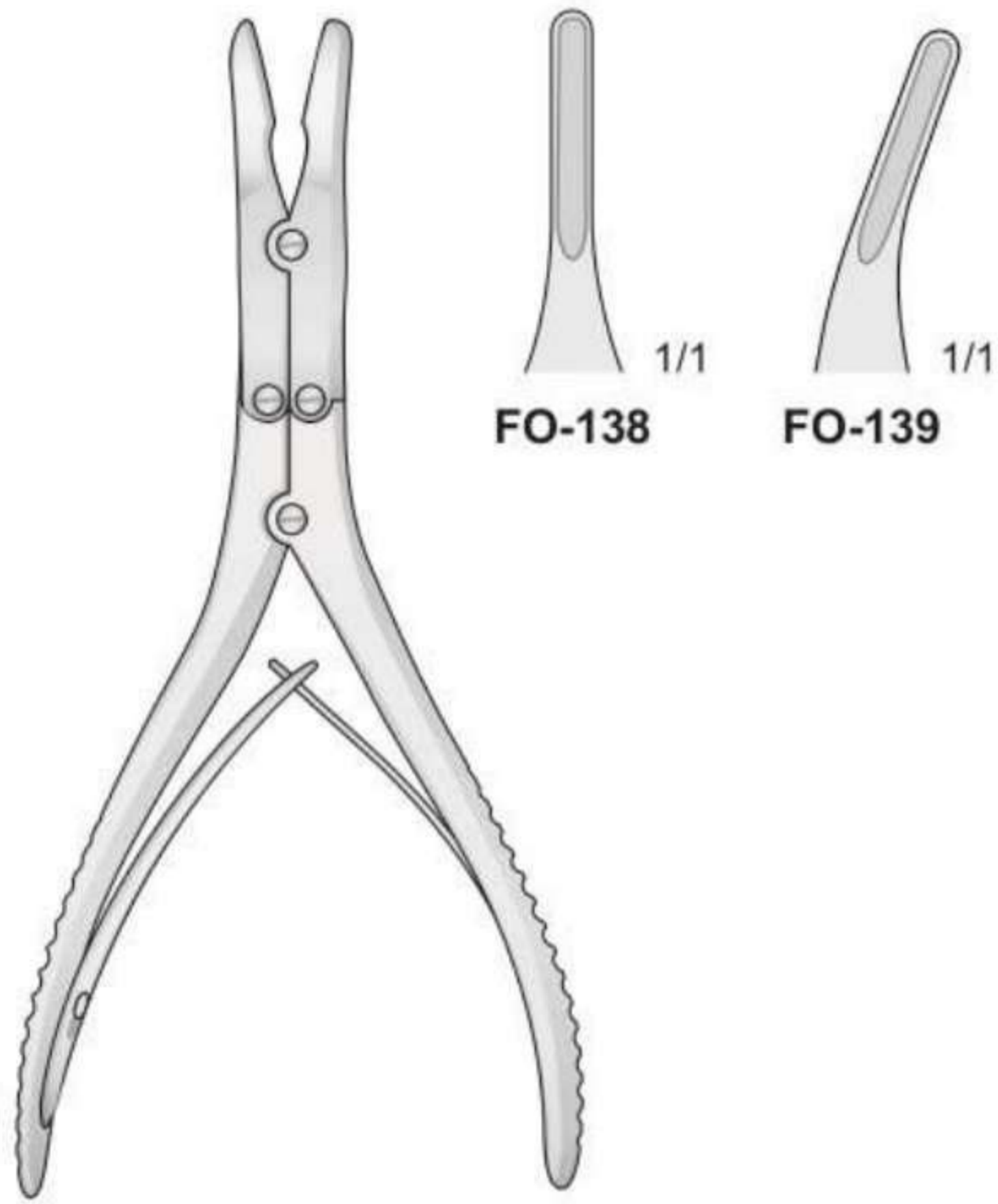

RUSKIN
FO-138/FO-139
150 mm

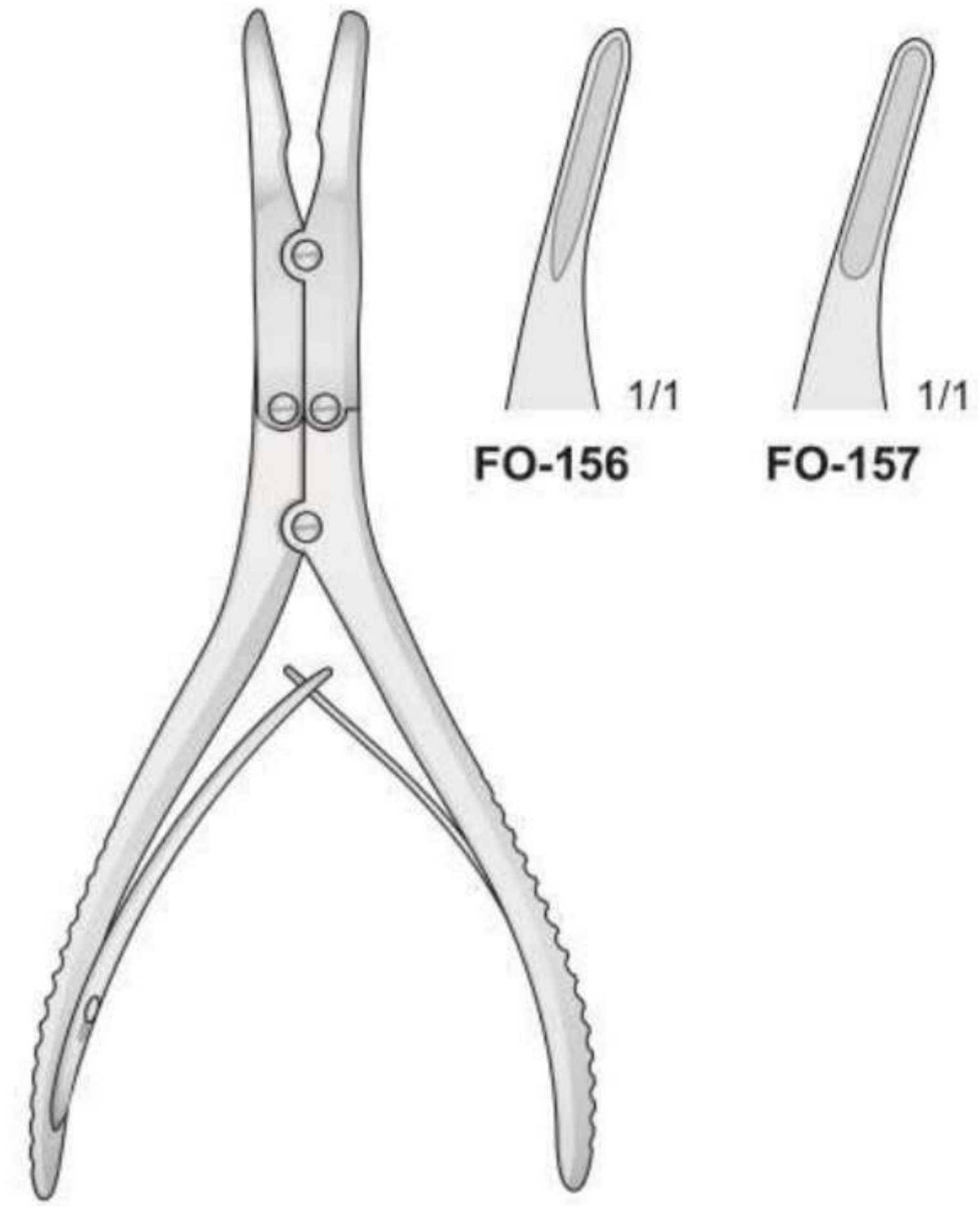

KLEINERT-KUTZ
FO-156/FO-157
155 mm

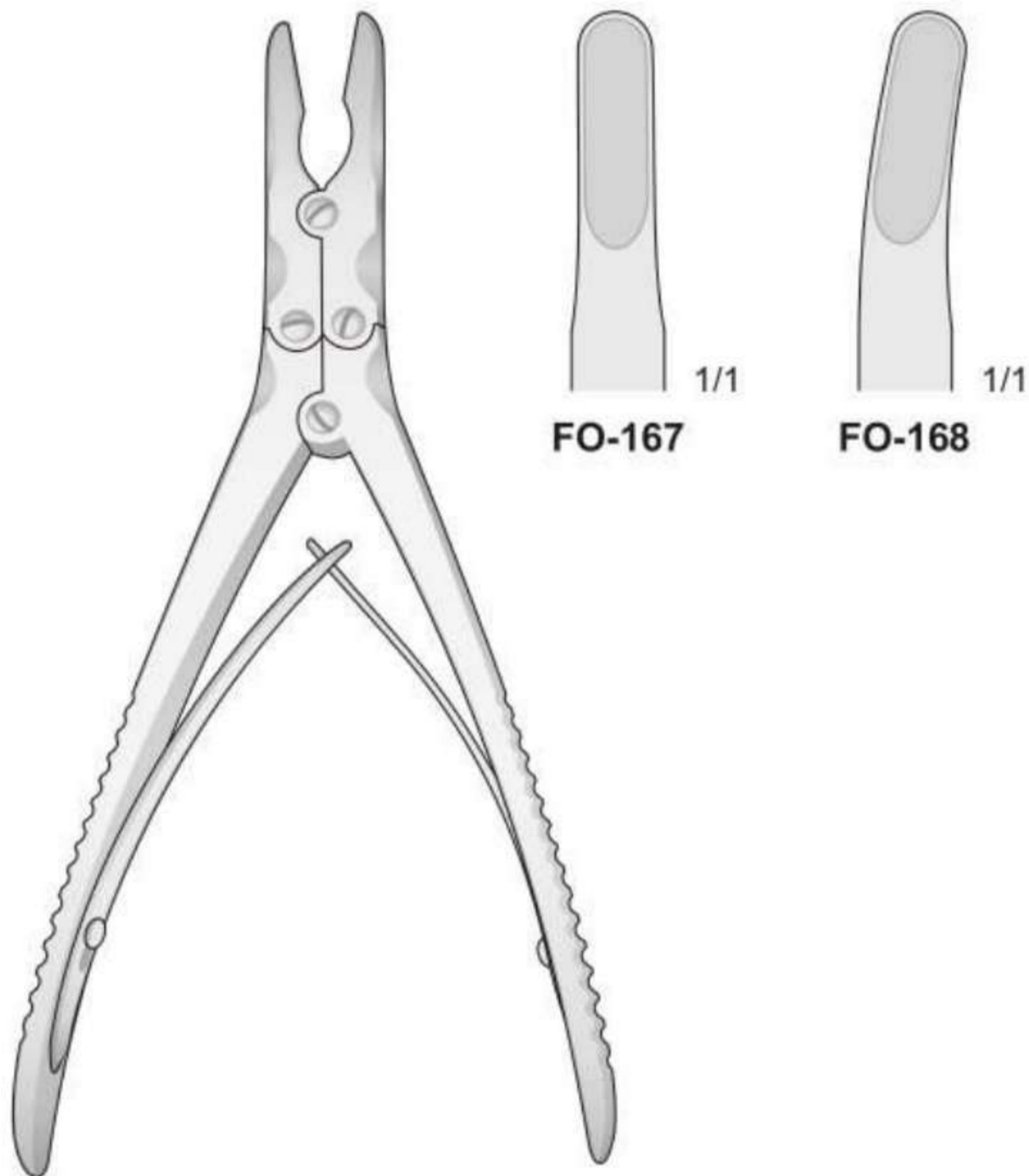

RUSKIN
FO-167/FO-168
185 mm

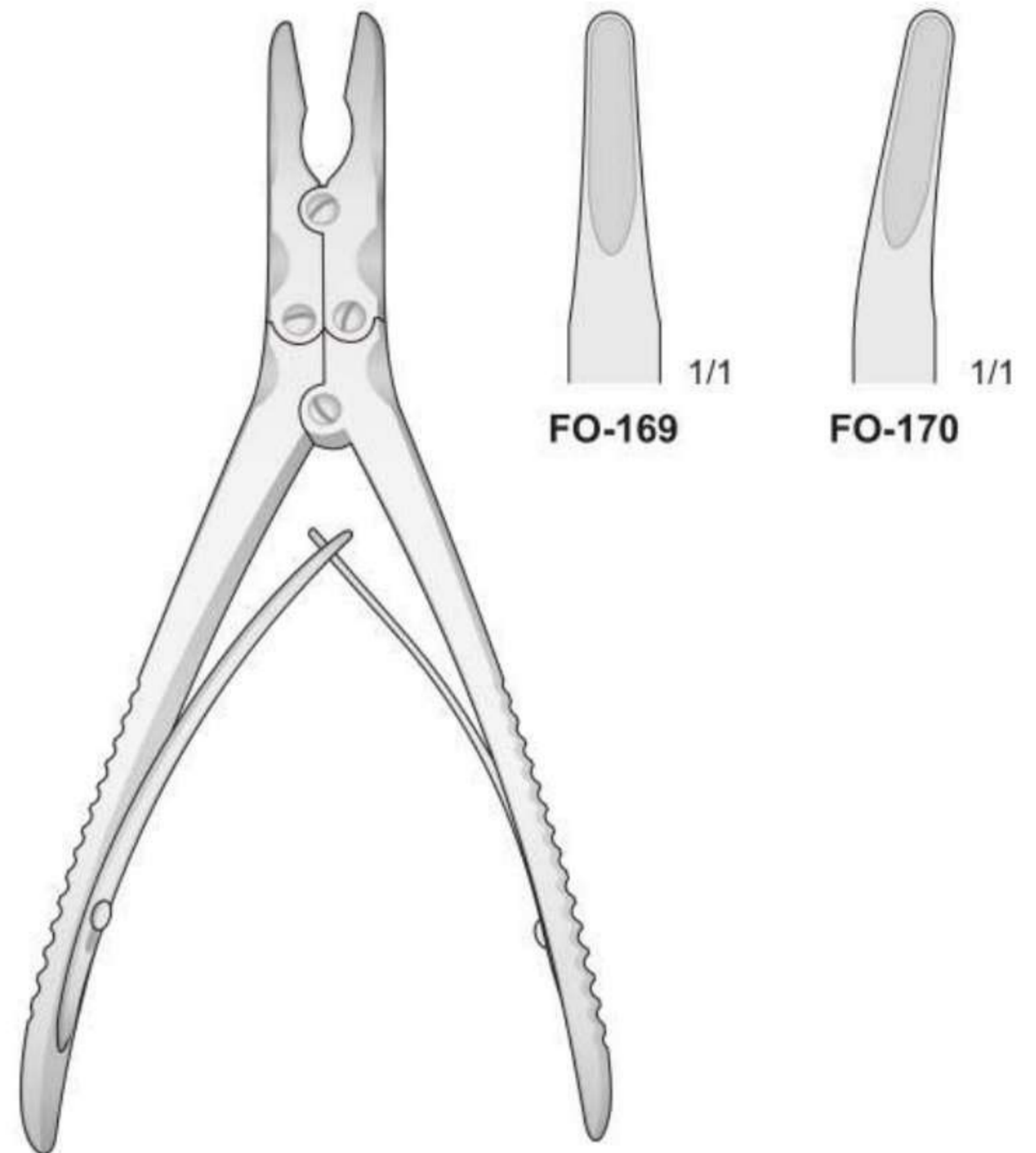

RUSKIN
FO-169/FO-170
185 mm

Hohlmeißelzangen

Bone rongeurs

Pinze ossivore

Pinza gubias

Pinces gouges

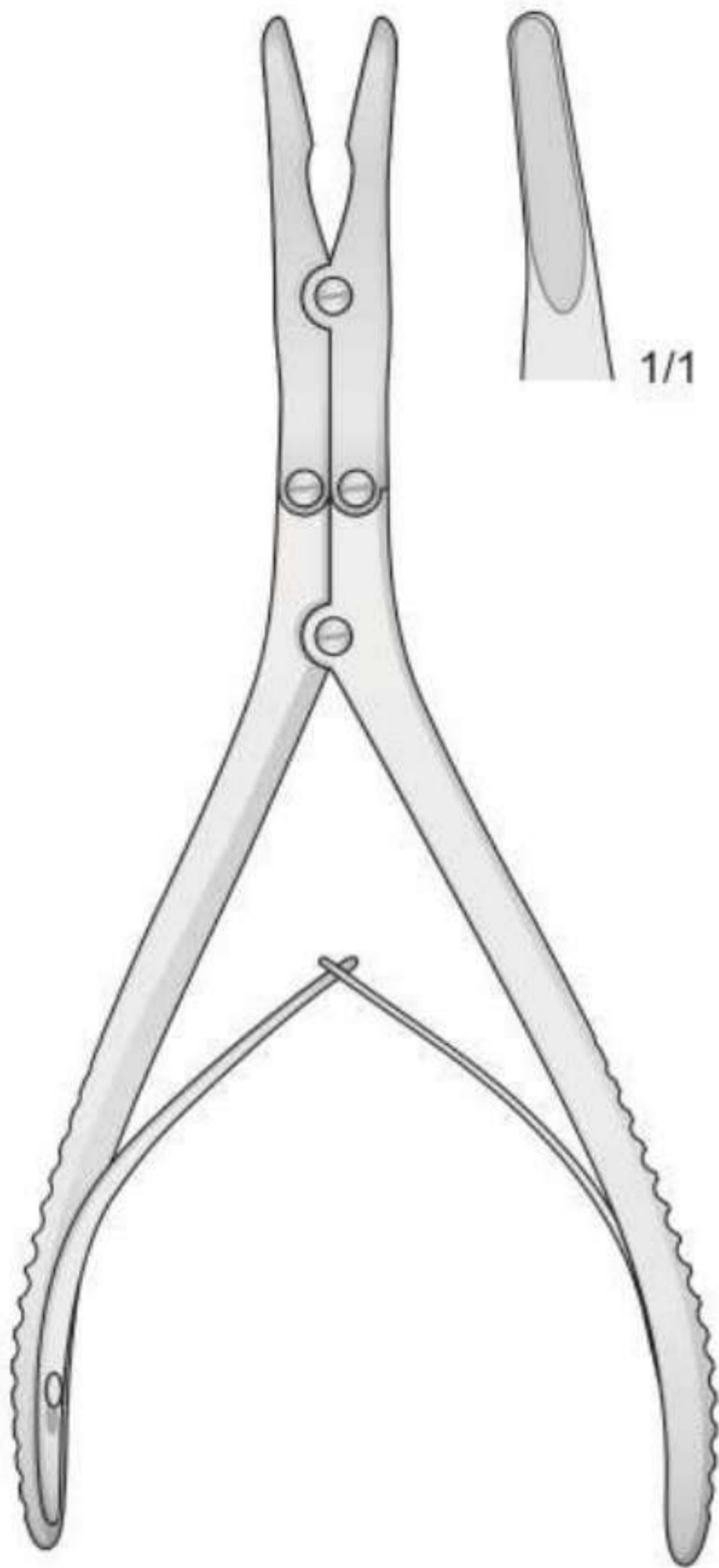

BEYER
FO-20
180 mm

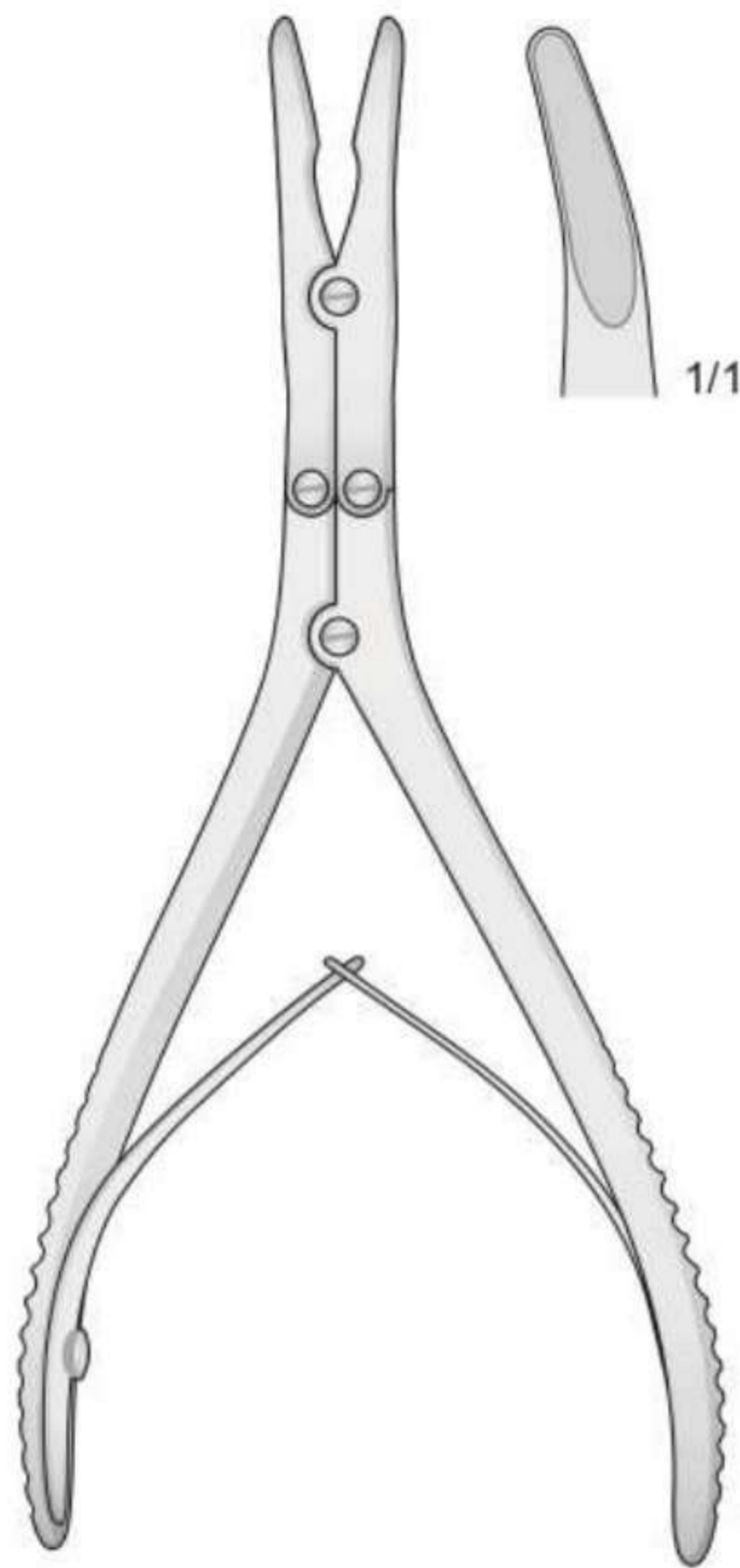

ZAUFAL-JANSEN
FO-34
180 mm

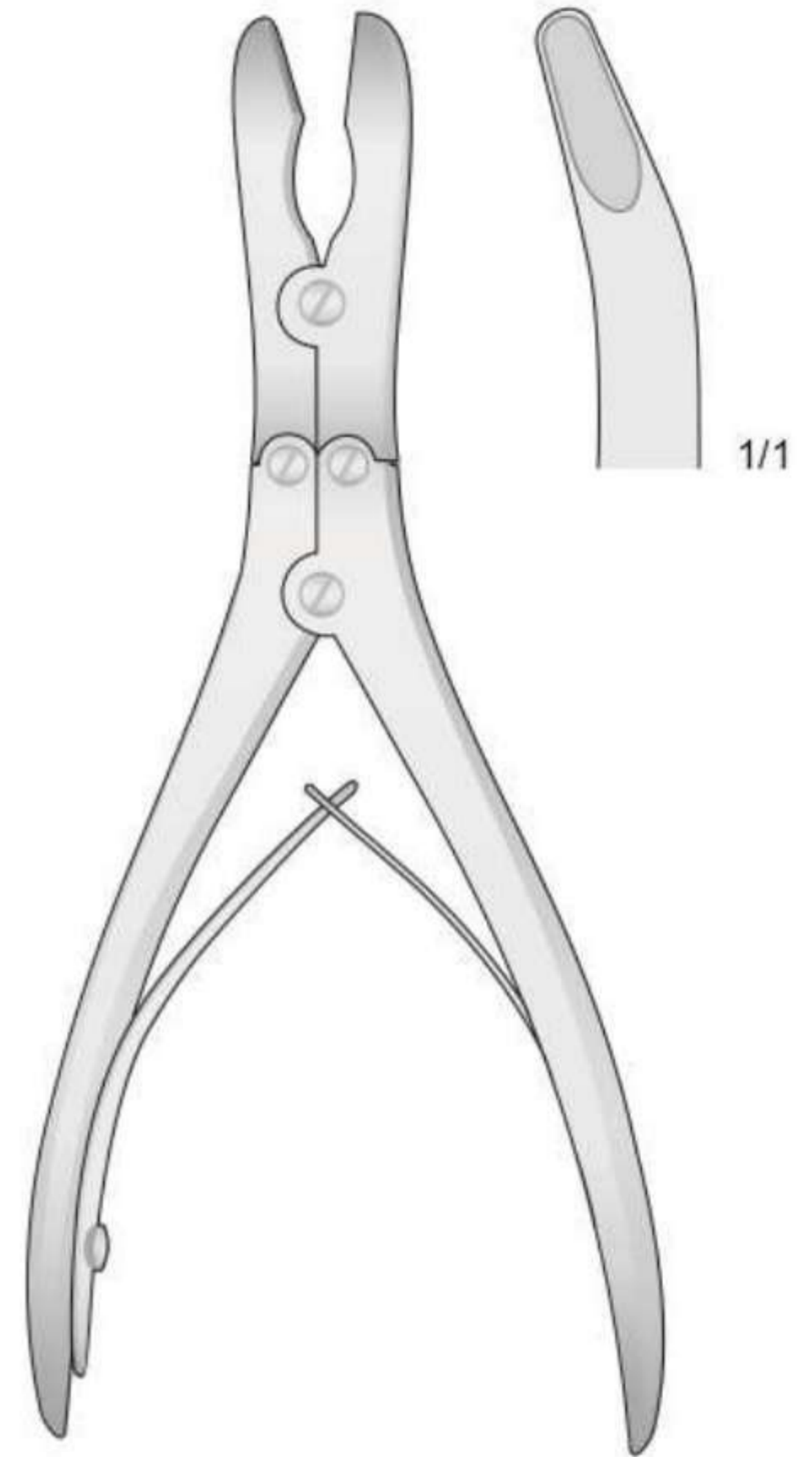

RUSKIN-STILLE
FO-35
180 mm

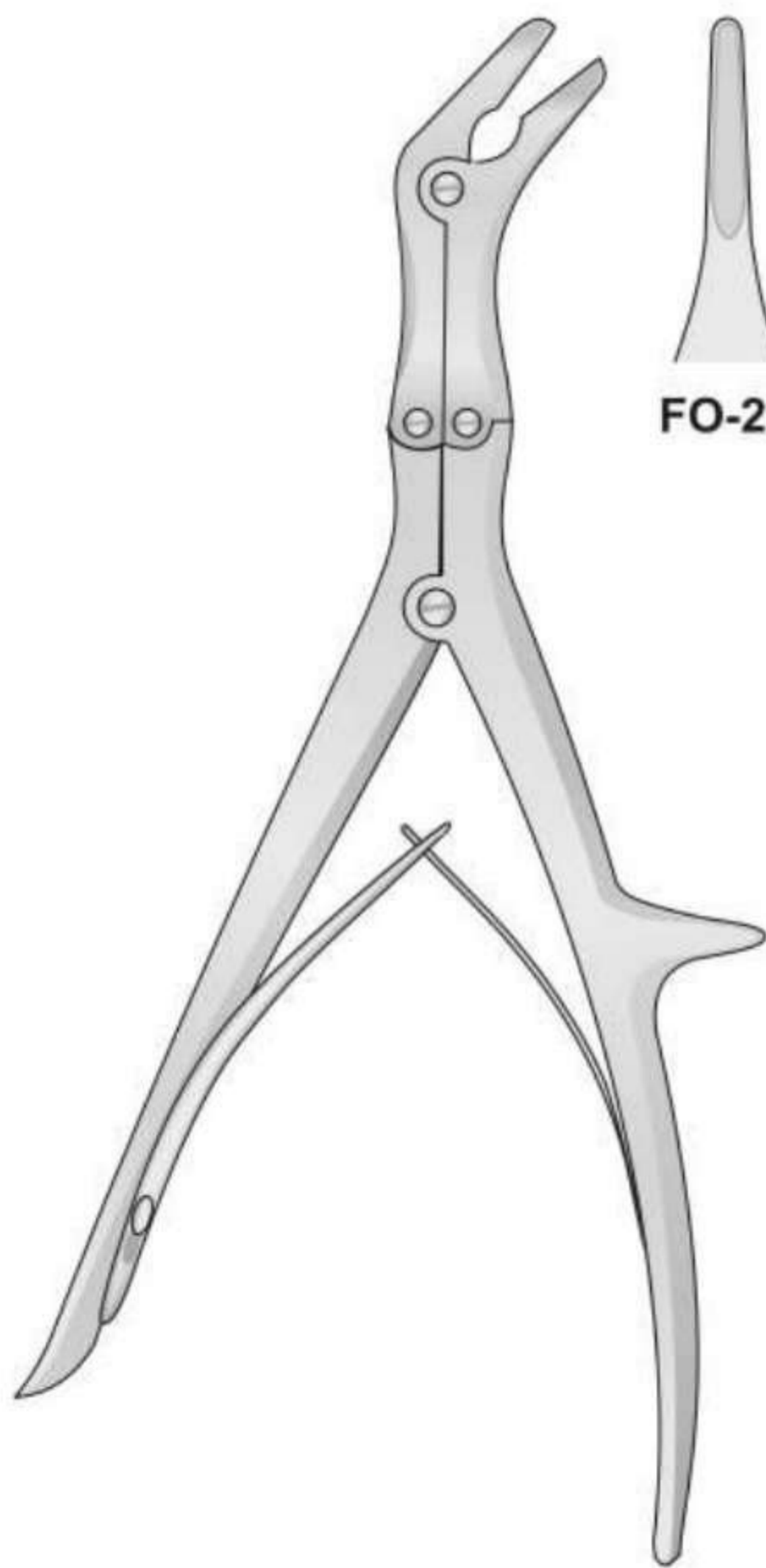

ECHLIN
FO-28/FO-30
230 mm

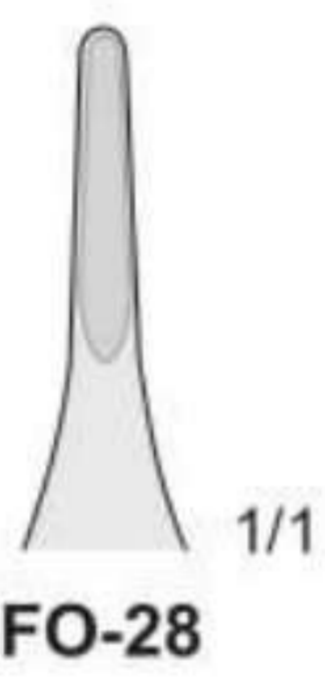

FO-28

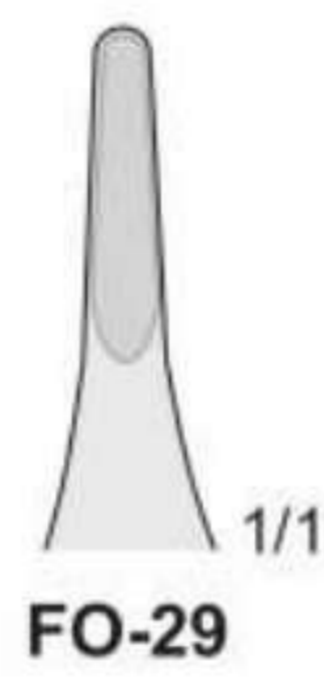

FO-29

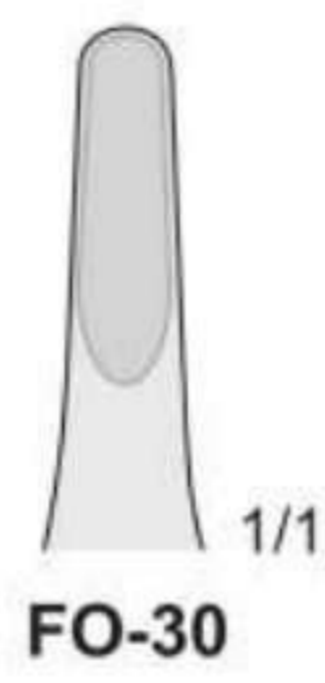

FO-30

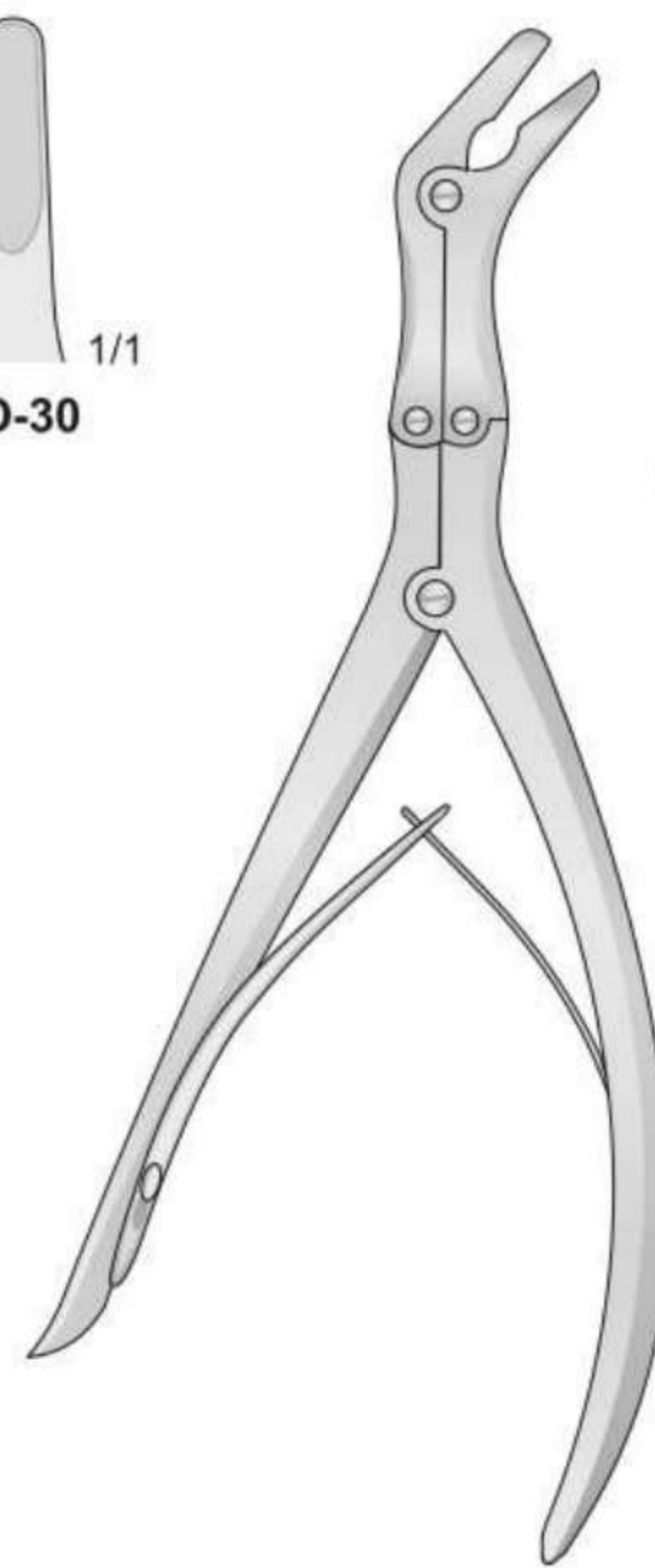

LEKSELL
FO-31/FO-32

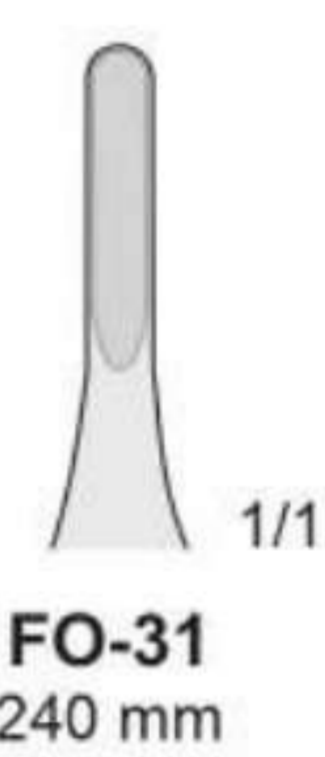

FO-31
240 mm

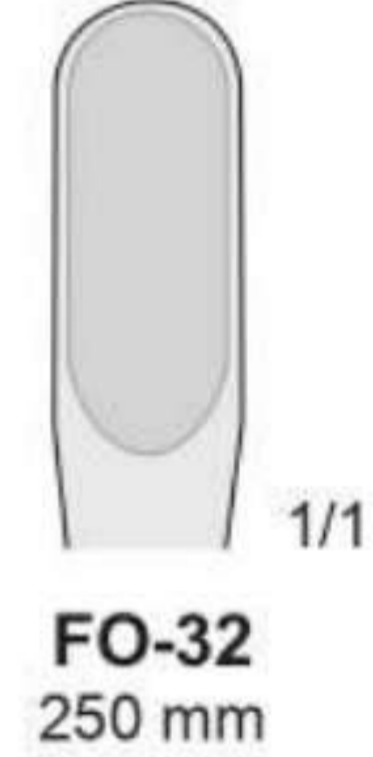

FO-32
250 mm

Hohlmeißelzangen

Bone rongeurs

Pinze ossivore

Pinza gubias

Pinces gouges

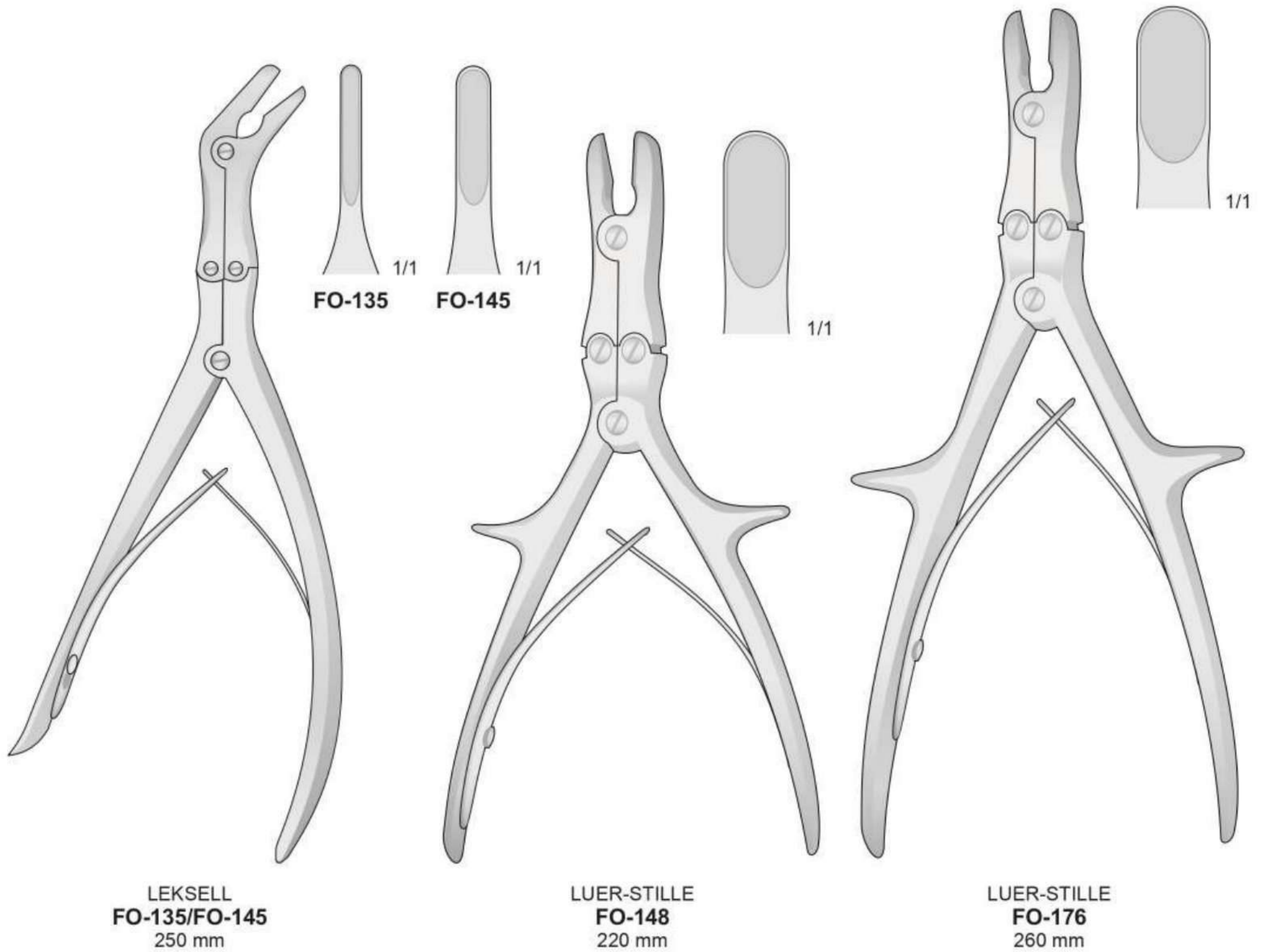

Hohlmeißelzangen

Bone rongeurs

Pinze ossivore

Pinza gubias

Pinces gouges

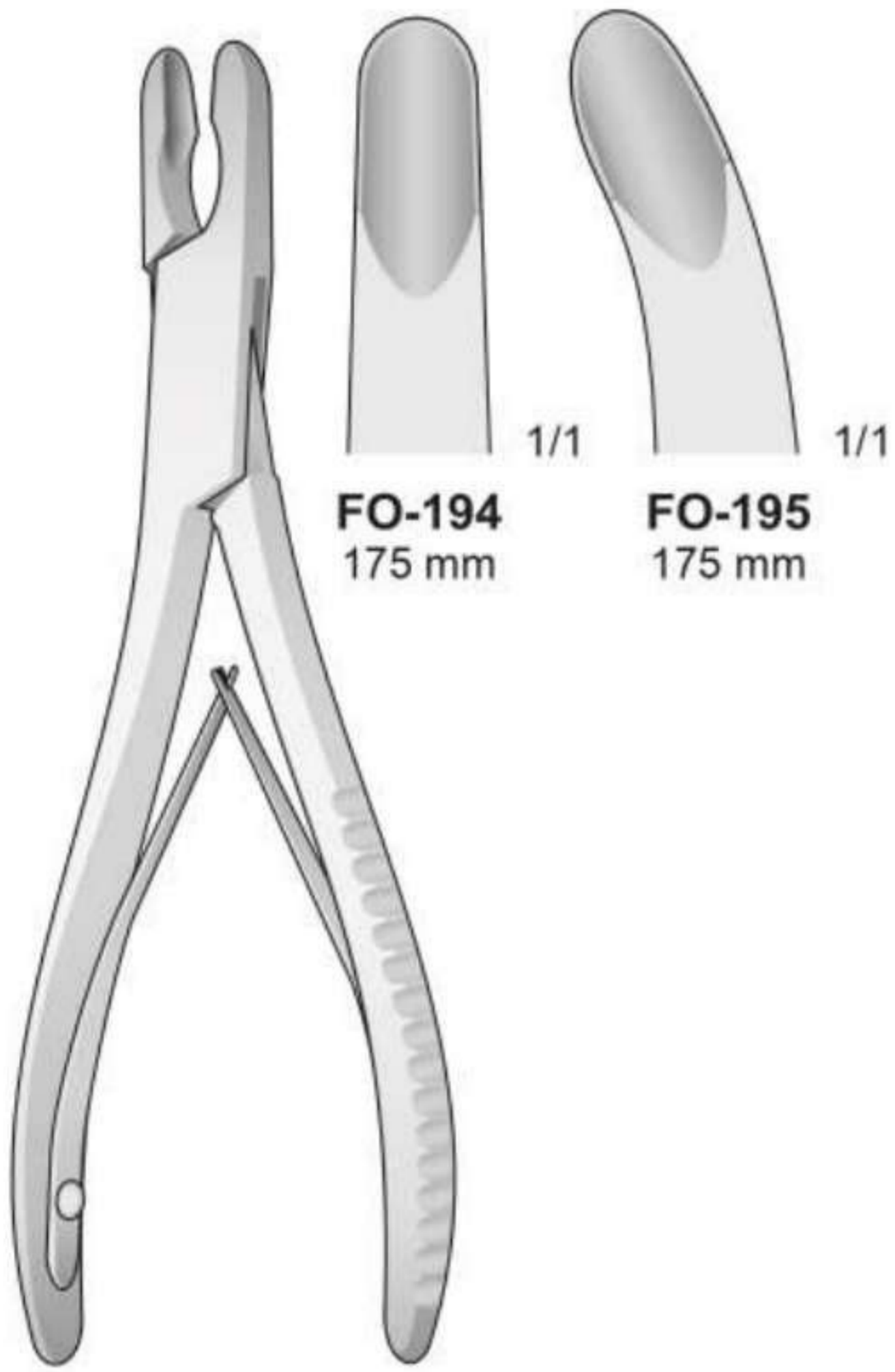

FO-194
175 mm

FO-195
175 mm

LUER
FO-194/FO-195
175 mm

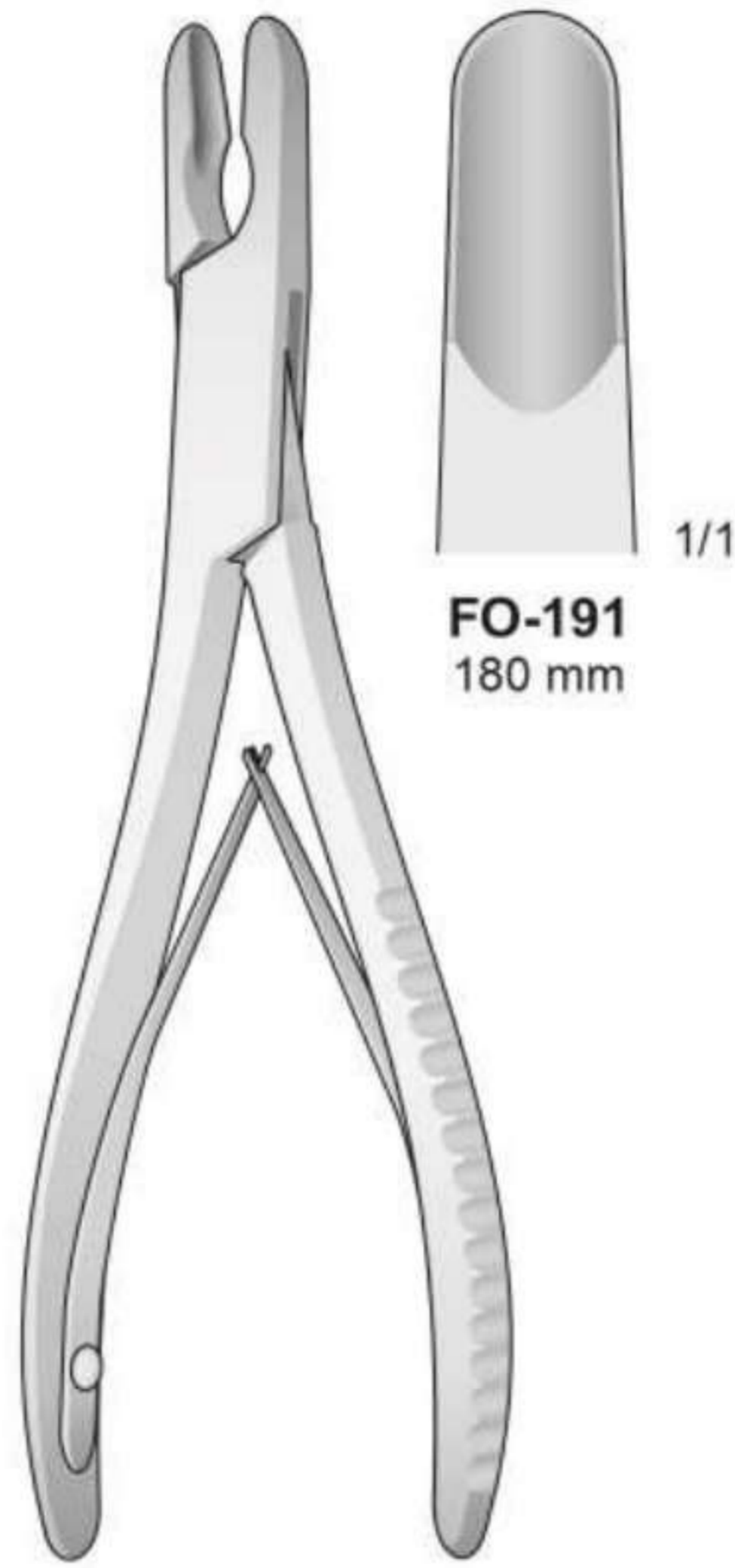

FO-191
180 mm

LUER
FO-191
180 mm

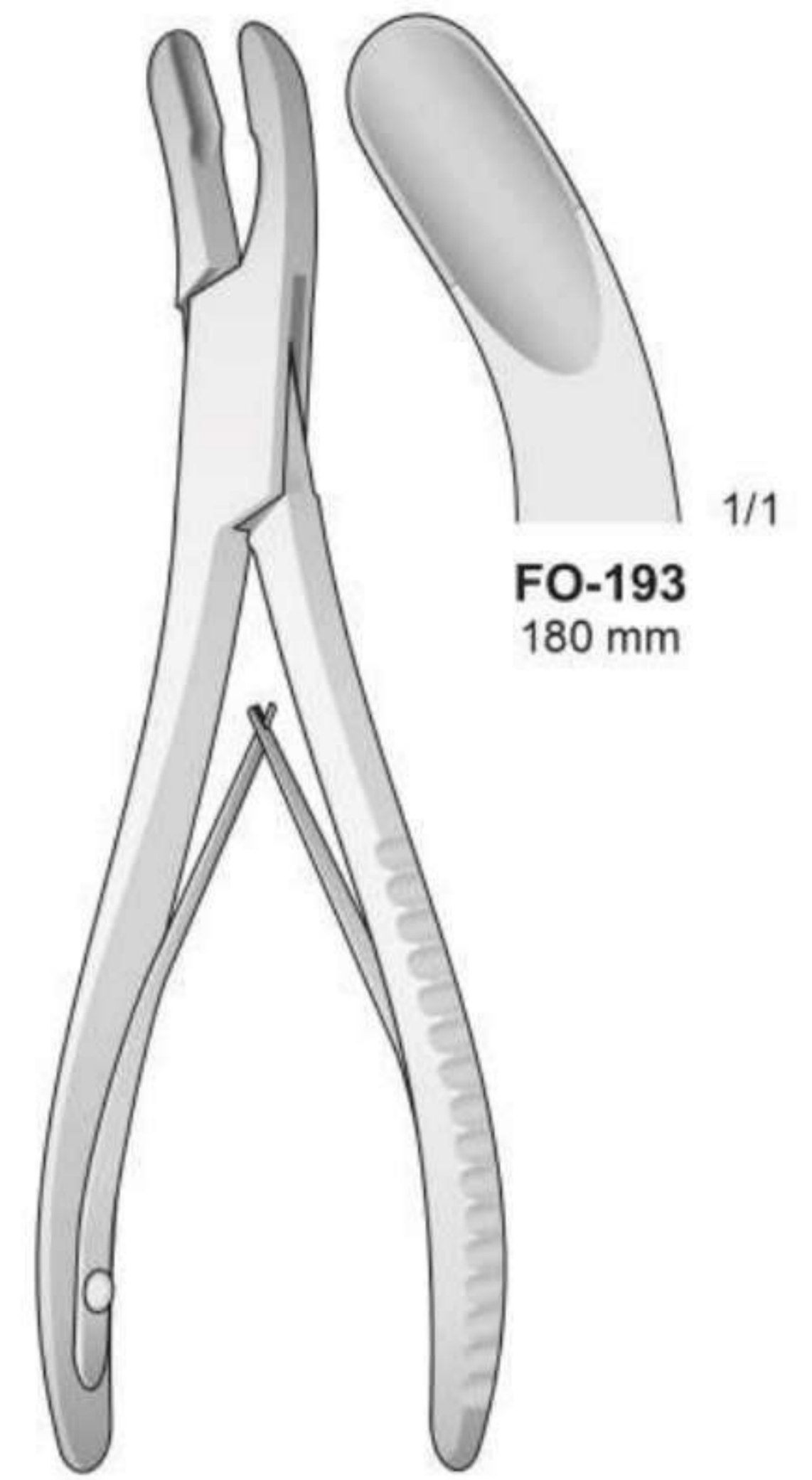

FO-193
180 mm

LUER
FO-193
180 mm

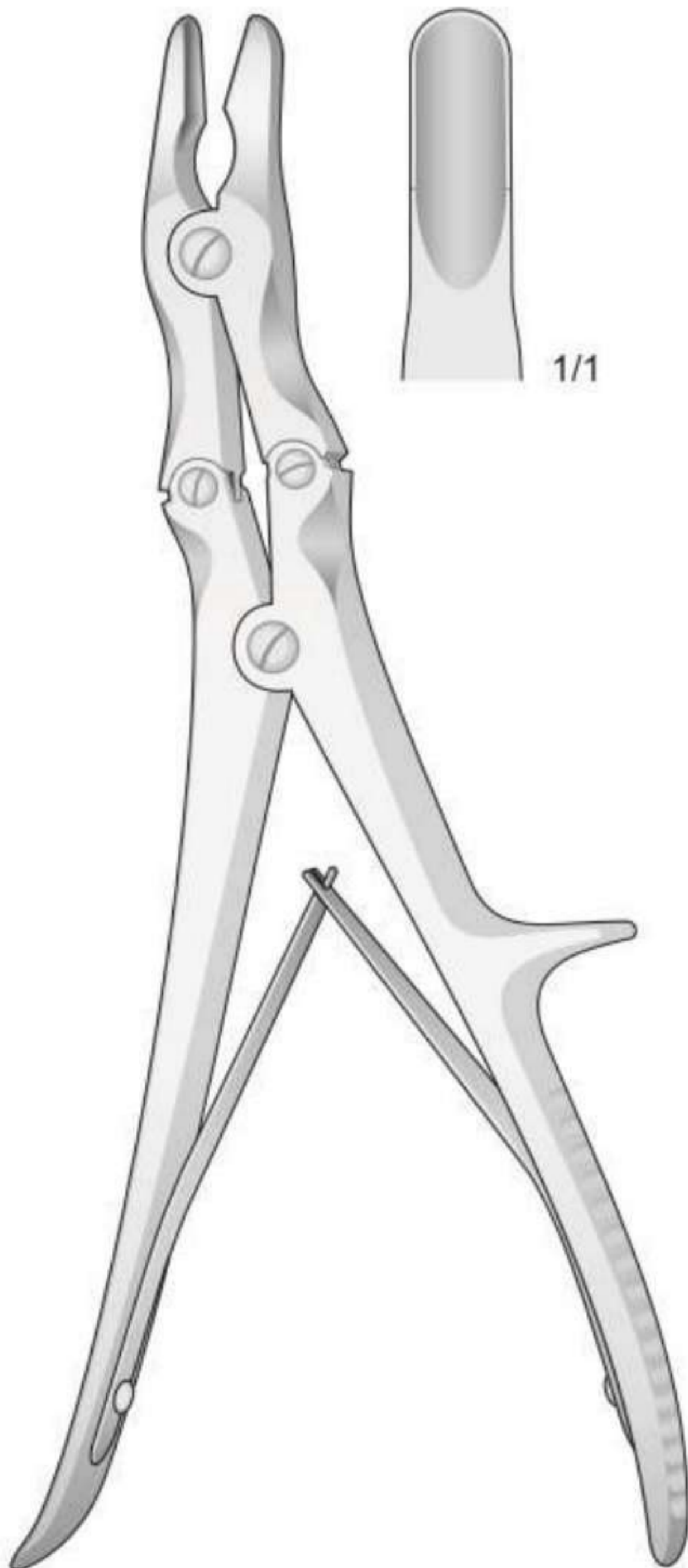

LEKSELL-STILLE
FO-196
240 mm

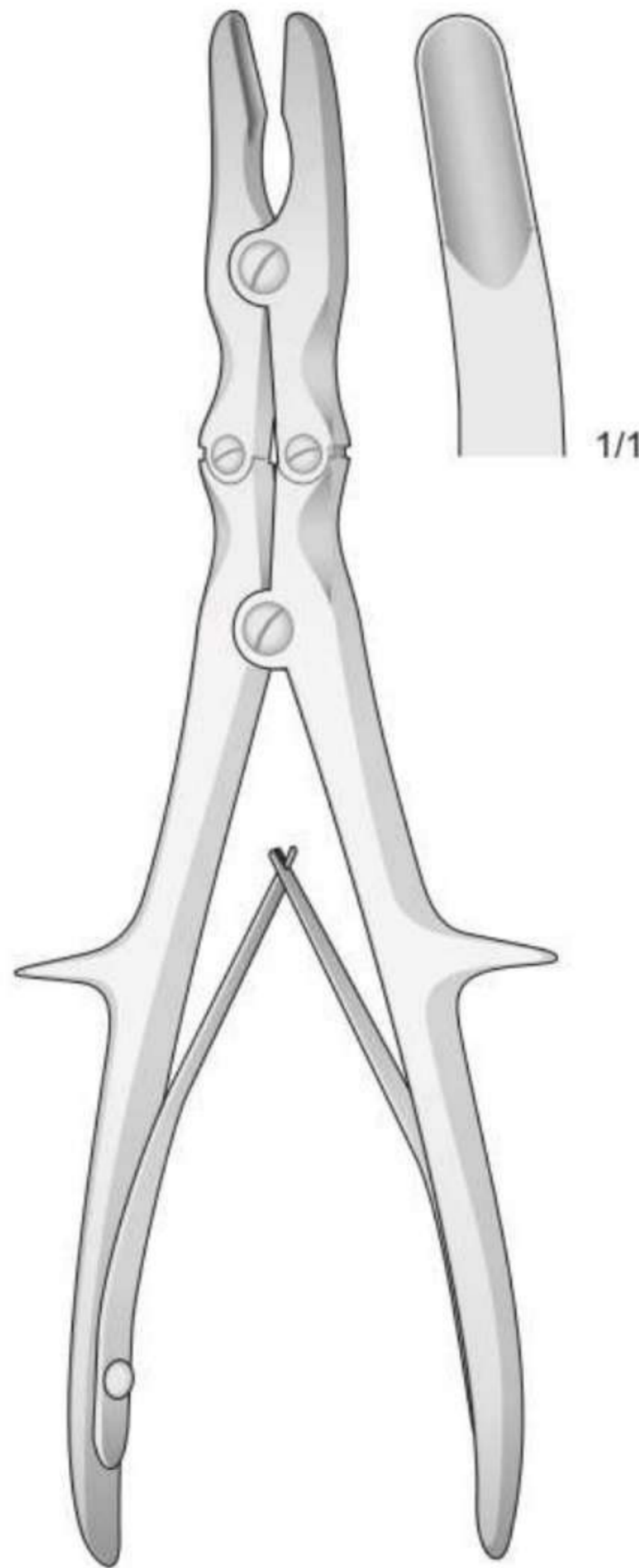

STILLE-RUSKIN
FO-197
240 mm

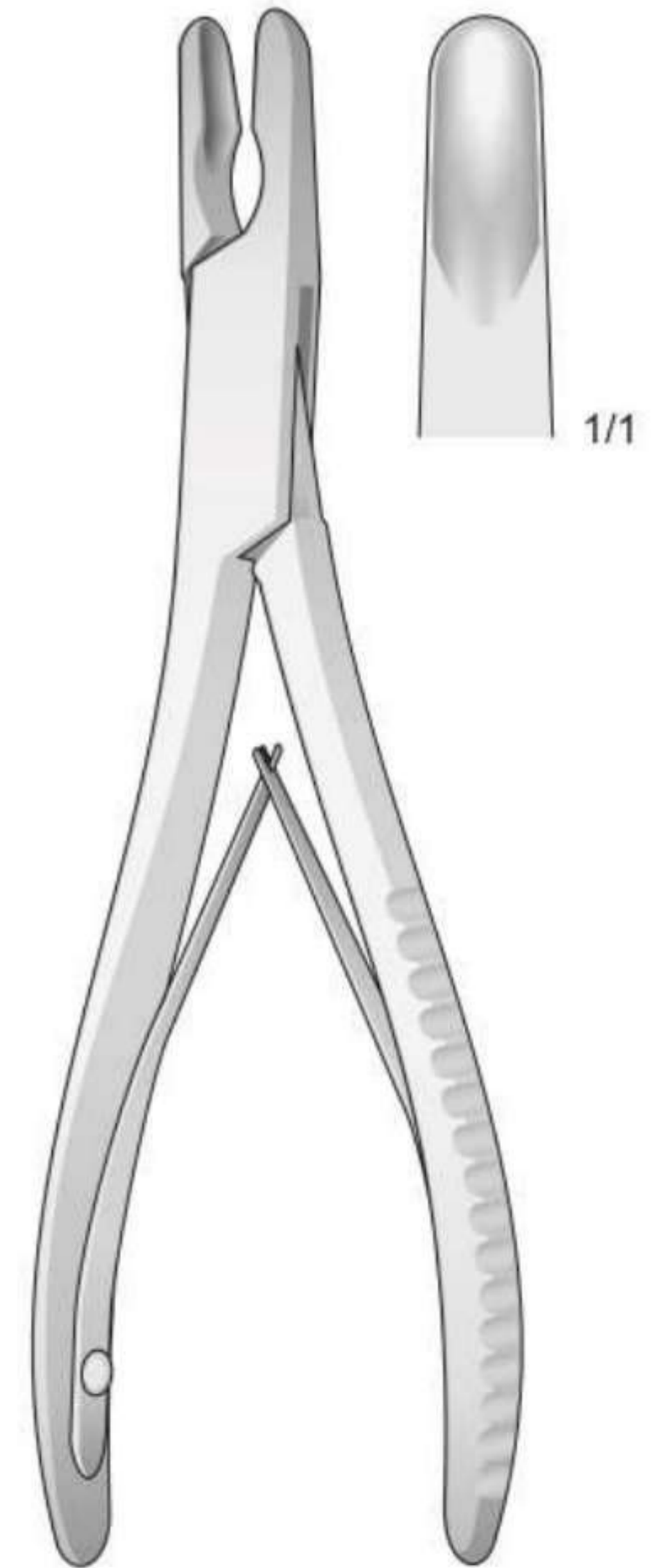

ADSON
FO-198
210 mm

Hohlmeißelzangen

Bone rongeurs

Pinze ossivore

Pinza gubias

Pinces gouges

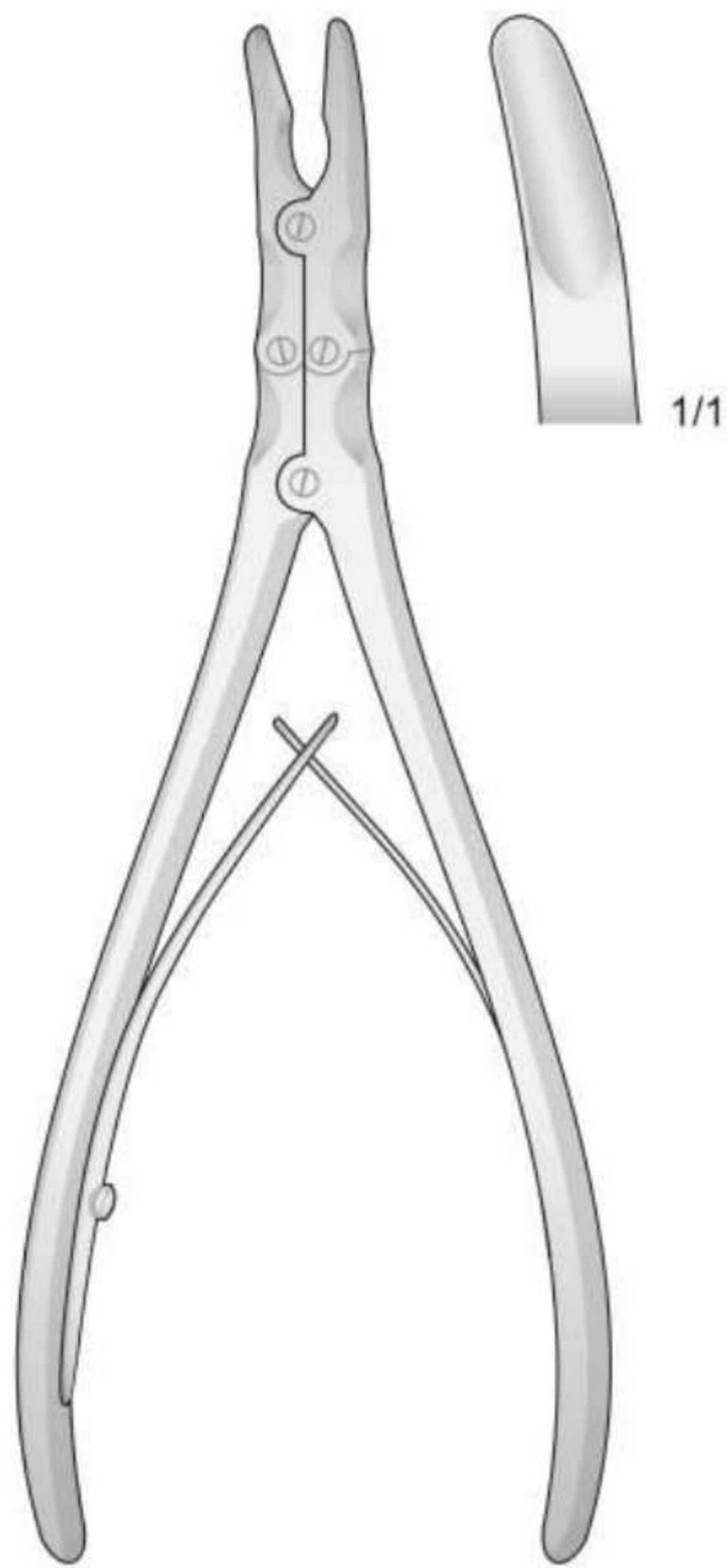

RÖTTGEN-RUSKIN
FO-199
240 mm

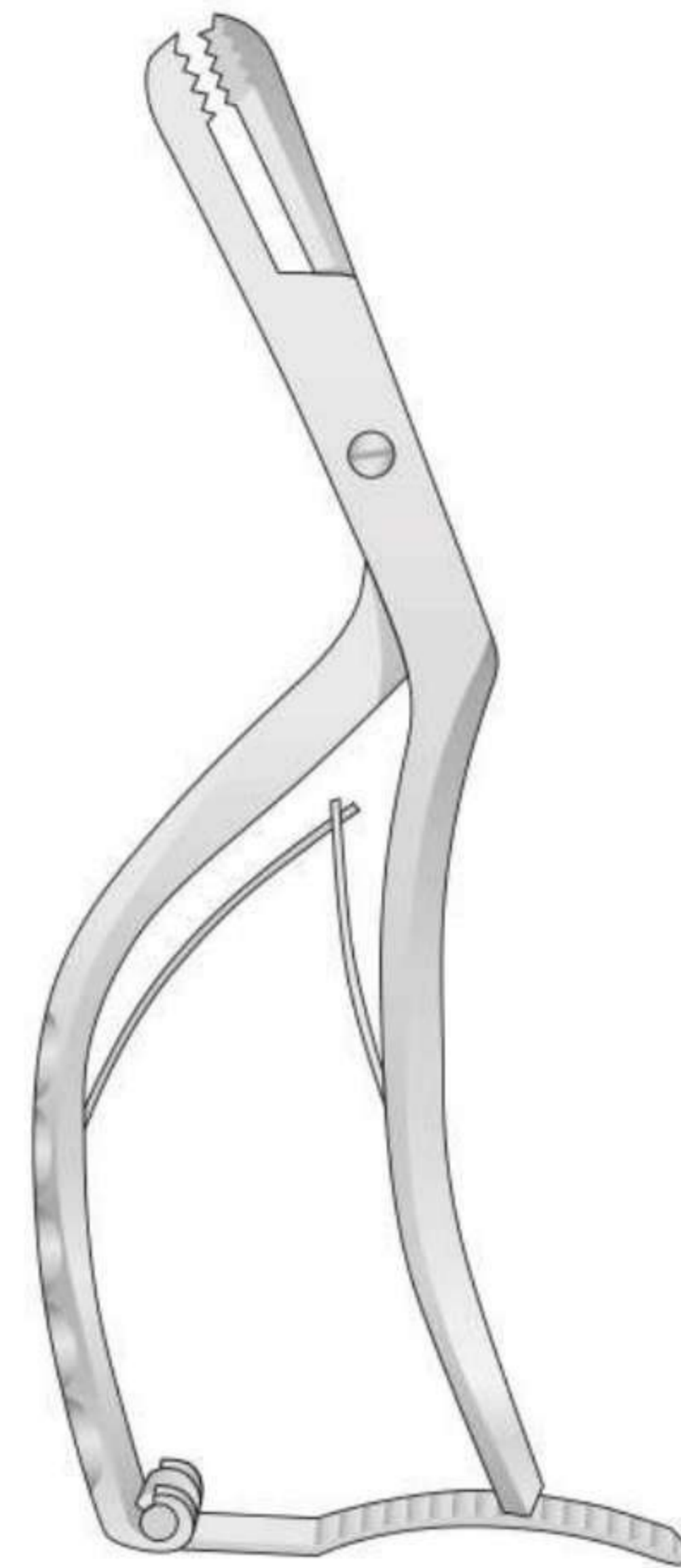

FO-140
200 mm

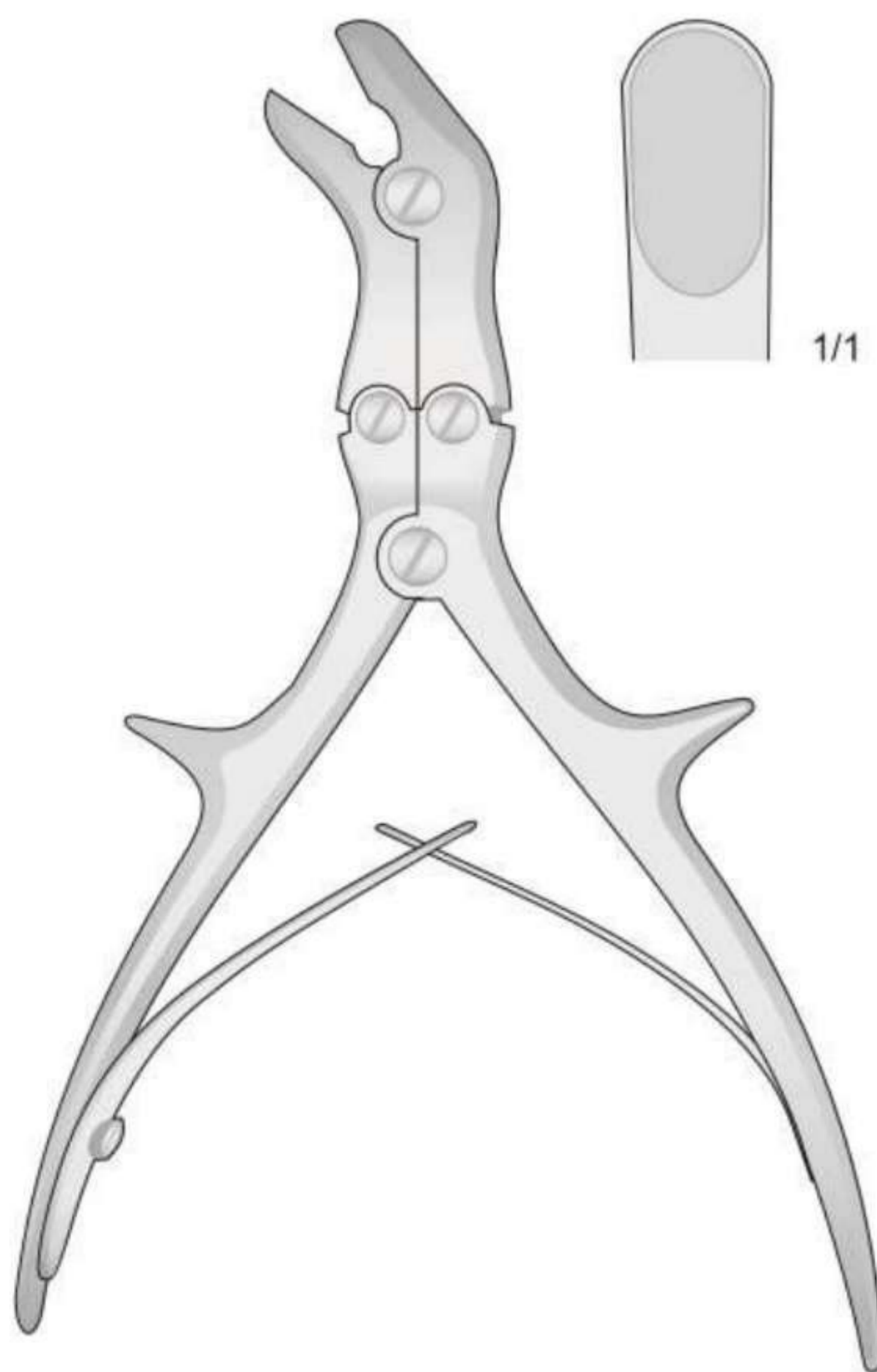

STILLE
FO-36
210 mm

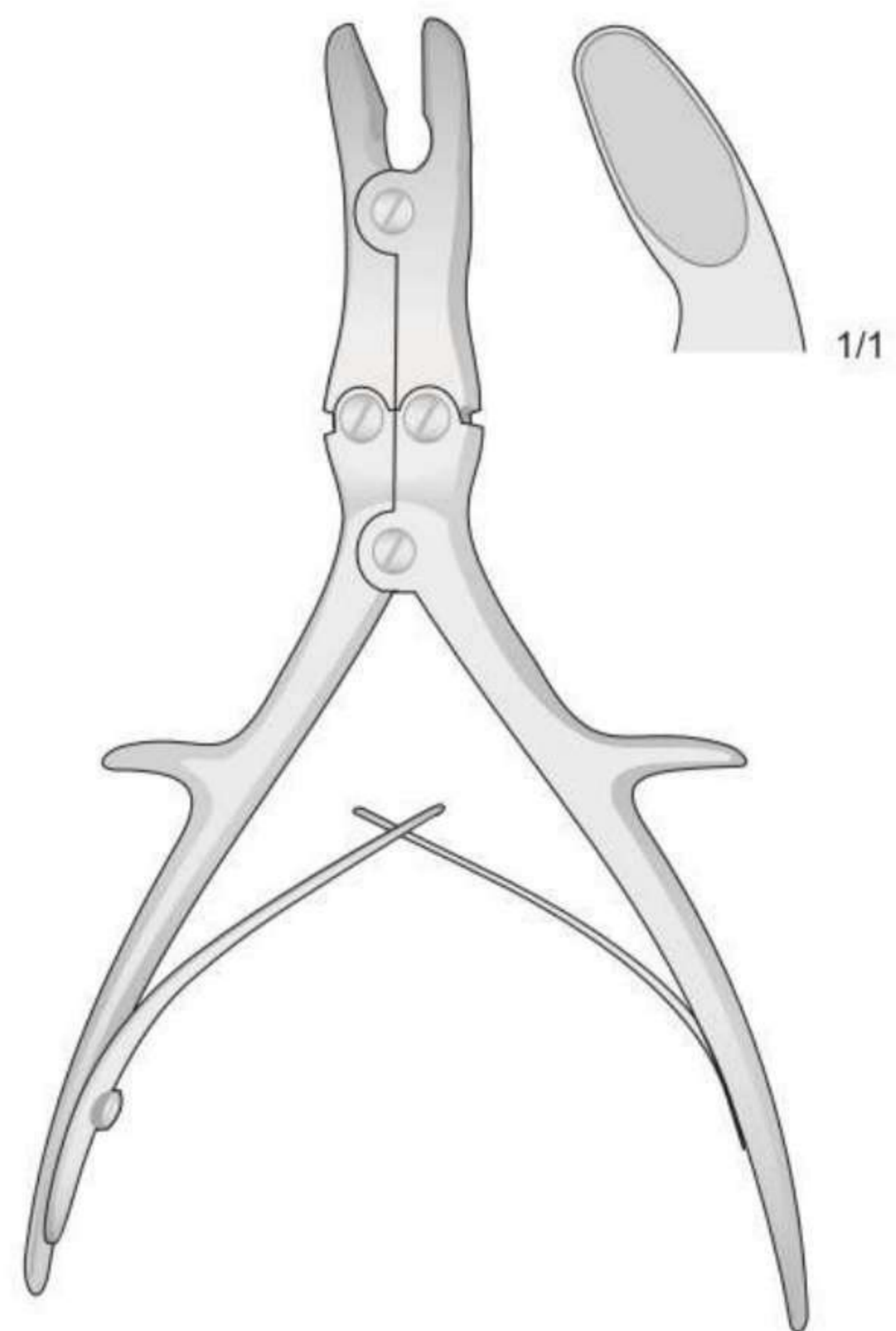

LUER-STILLE
FO-38
210 mm

Hohlmeißelzangen

Bone rongeurs

Pinze ossivore

Pinza gubias

Pinces gouges

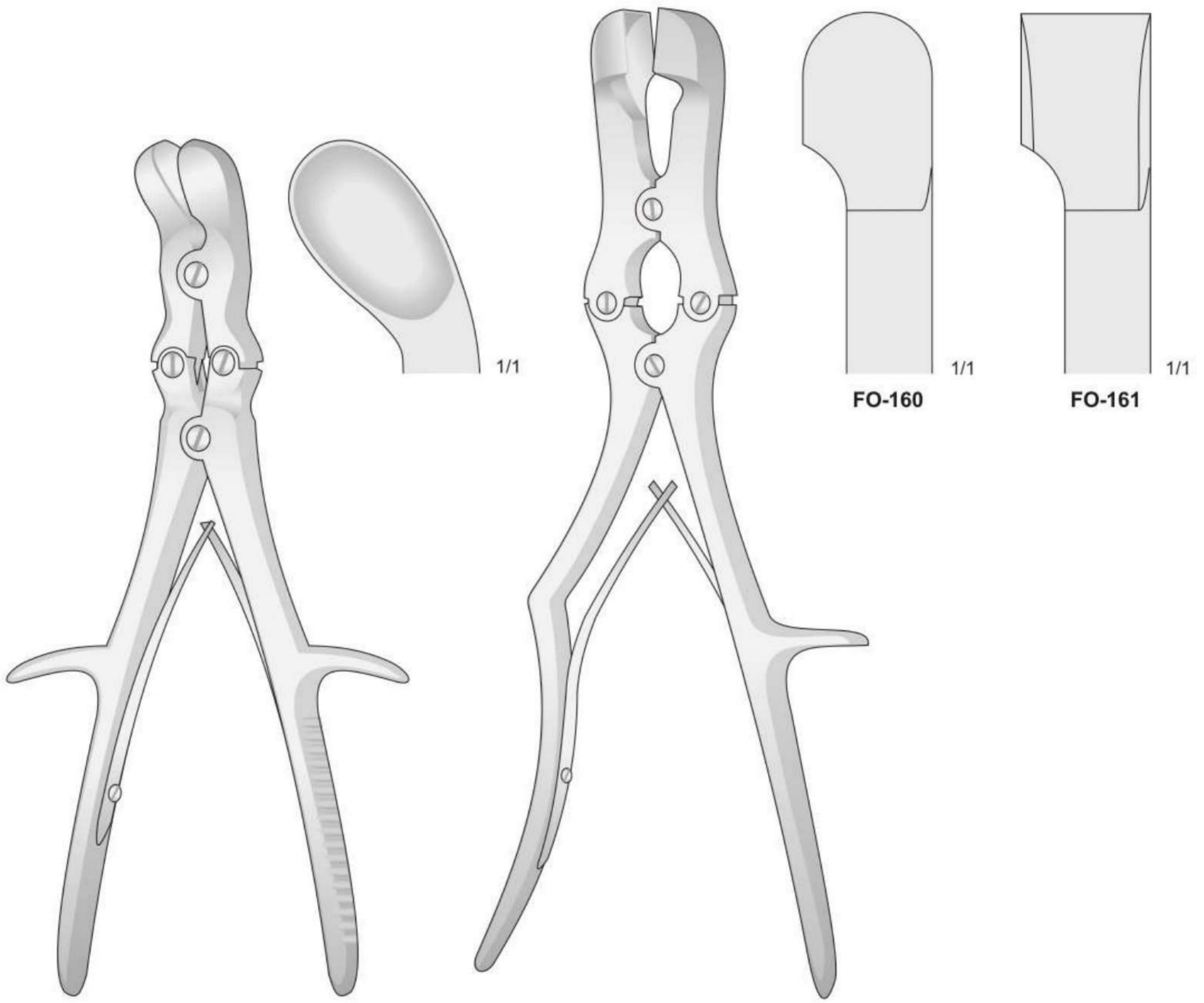

LUER-STILLE
FO-200
260 mm

SAUERBRUCH
FO-160/FO-161
300 mm

Hohlmeißelzangen

Bone rongeurs

Pinze ossivore

Pinza gubias

Pinces gouges

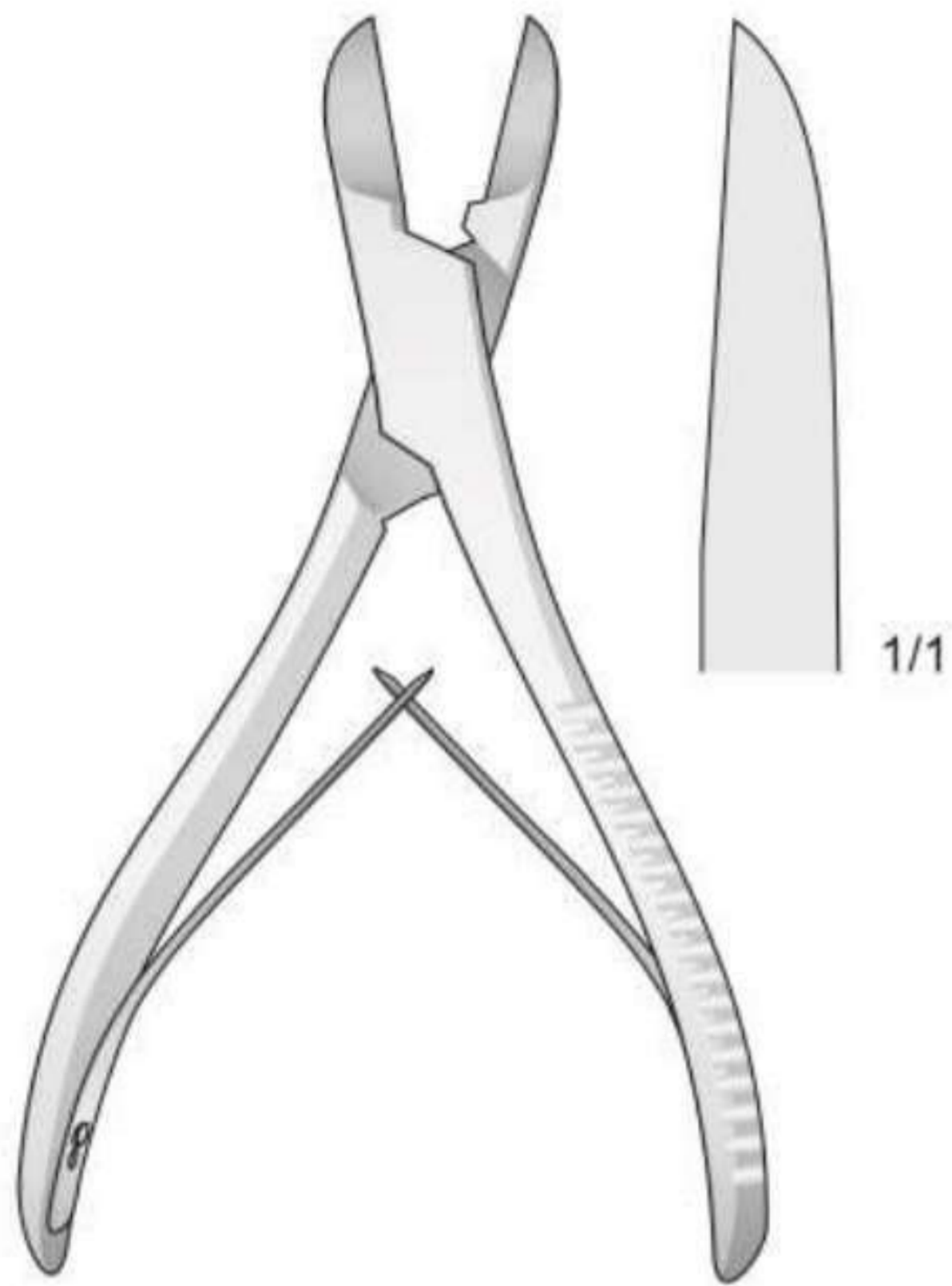

LISTON
LX-111
140 mm

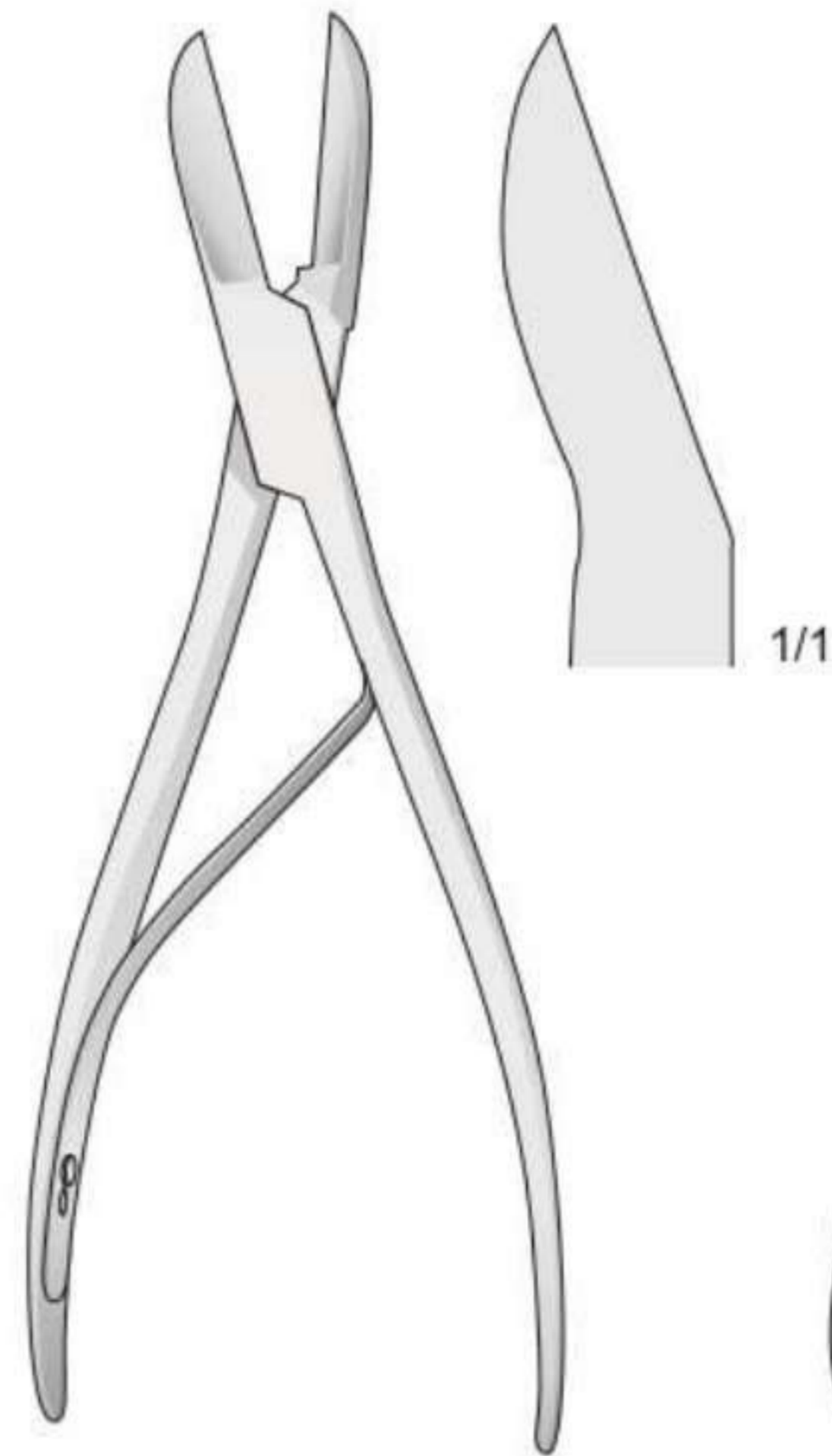

LISTON
LX-109
170 mm

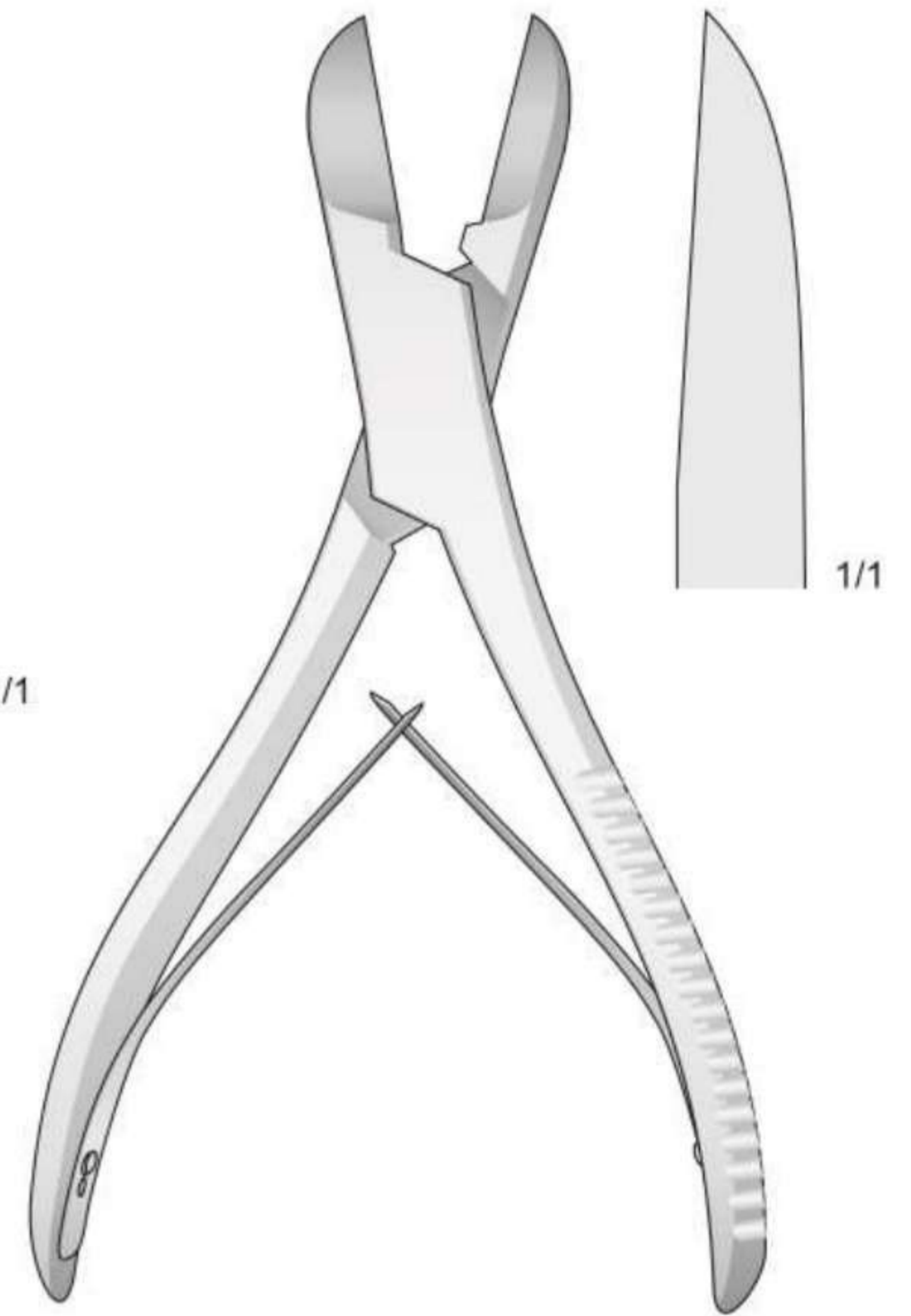

LISTON
LX-116
200 mm

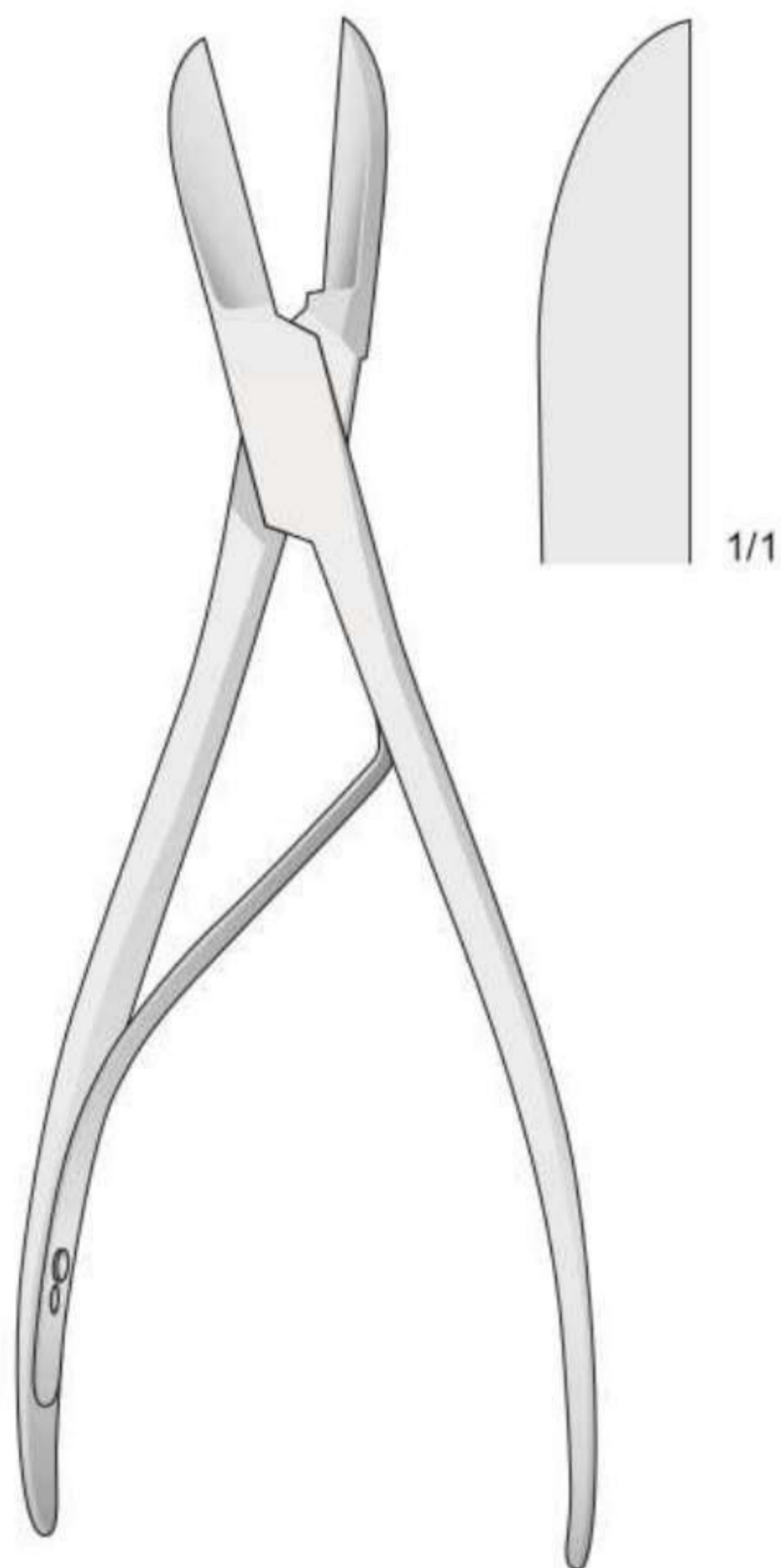

LISTON
LX-108
220 mm

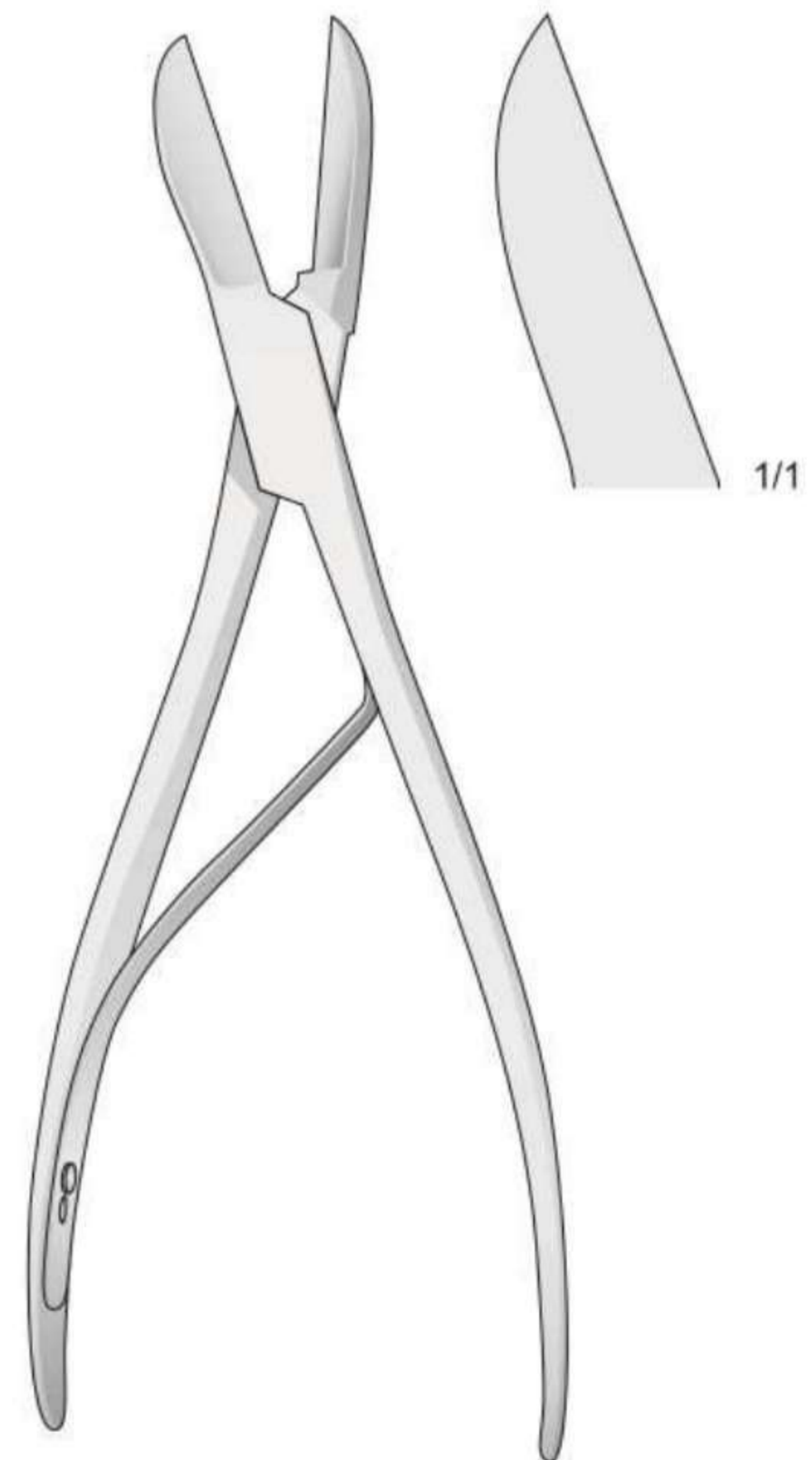

LISTON
LX-110
220 mm

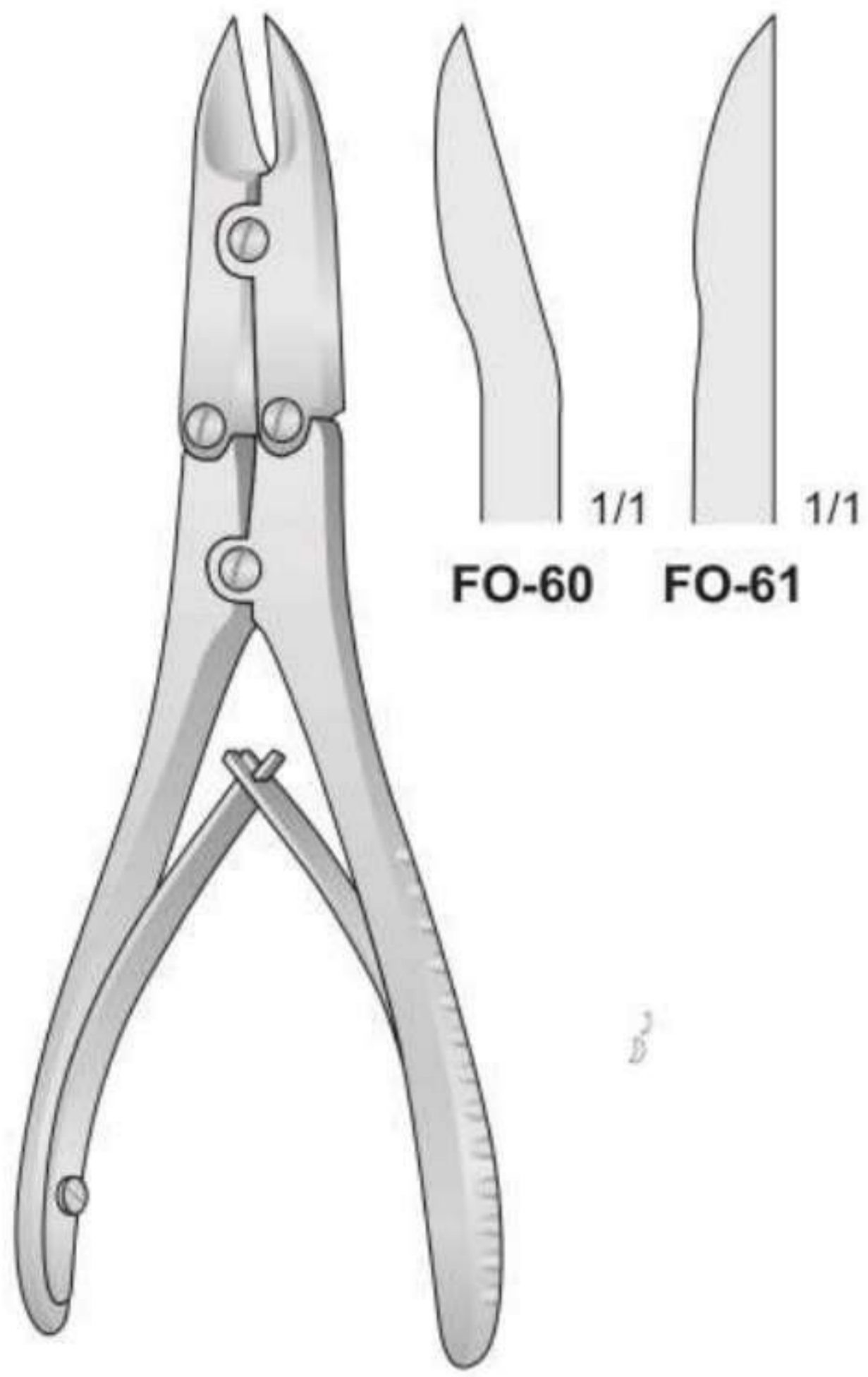

BÖHLER
FO-60/FO-61
150 mm

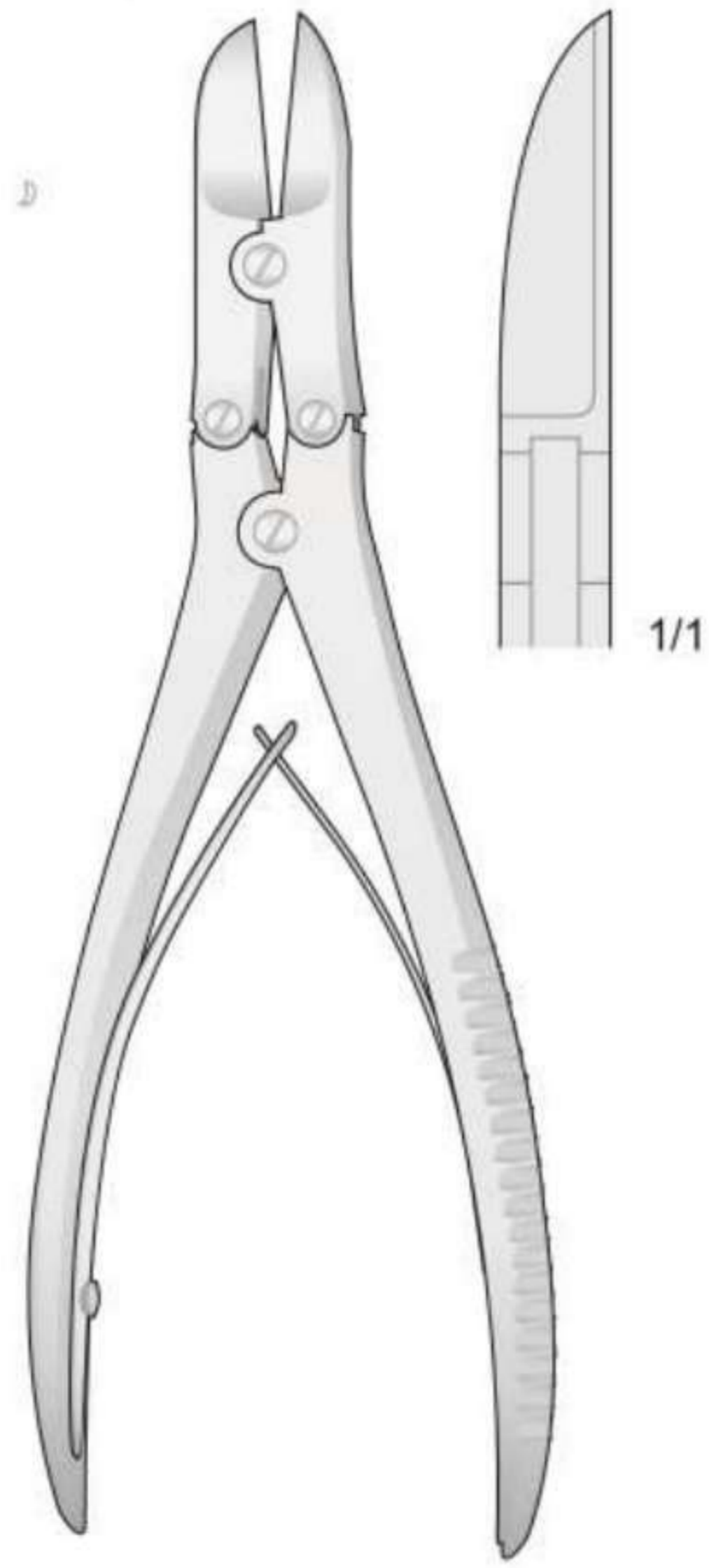

RUSKIN-LISTON
FO-108
190 mm

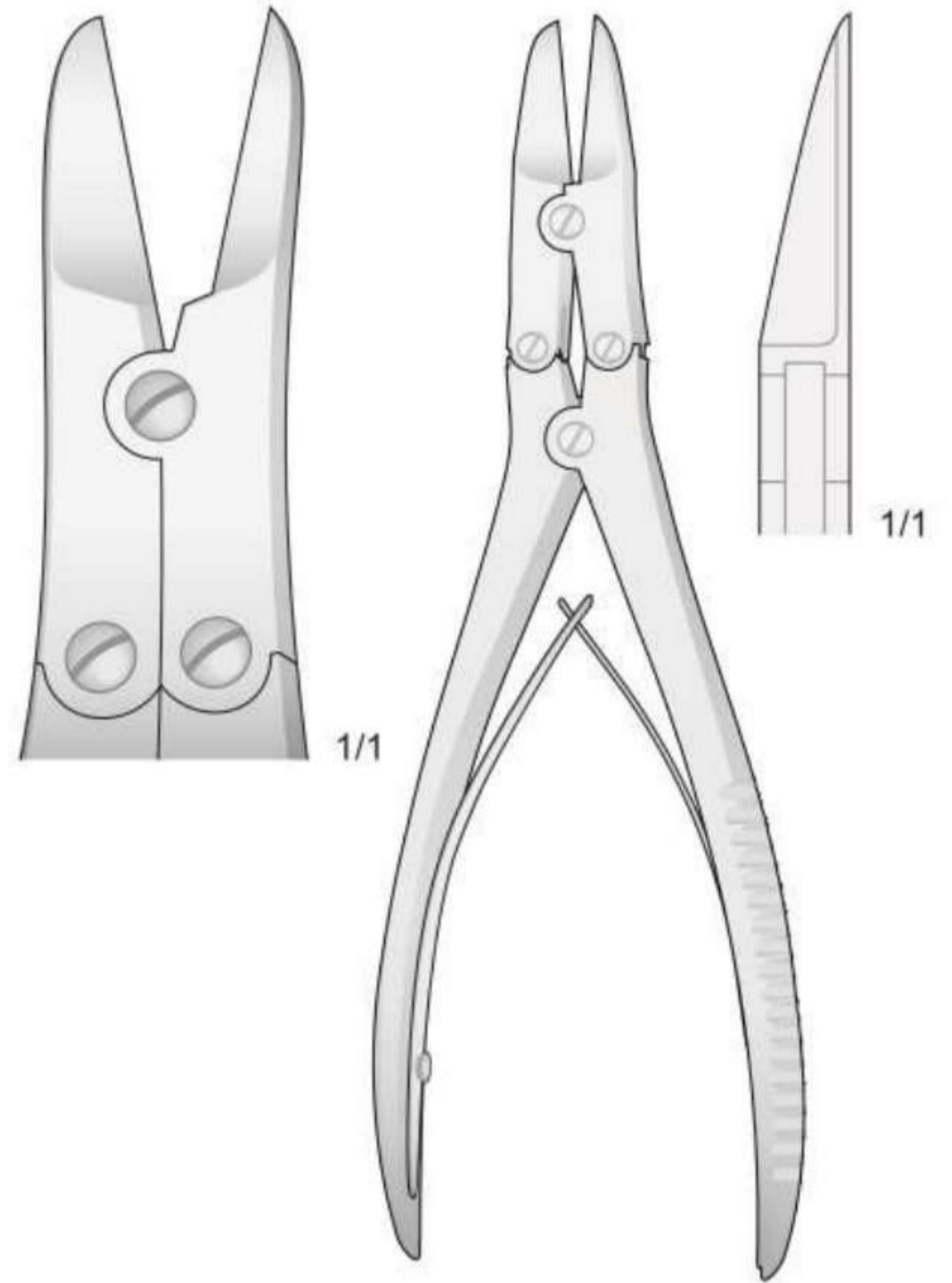

RUSKIN-LISTON
FO-178
190 mm

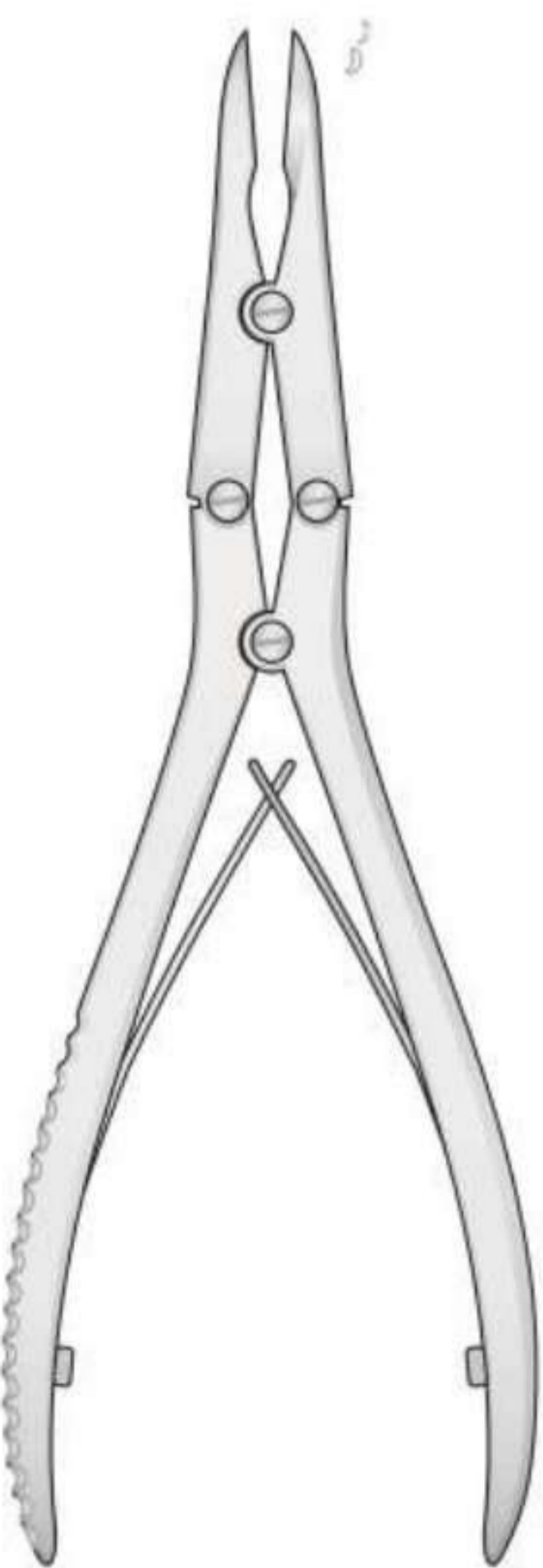

FO-58/FO-59
180 mm

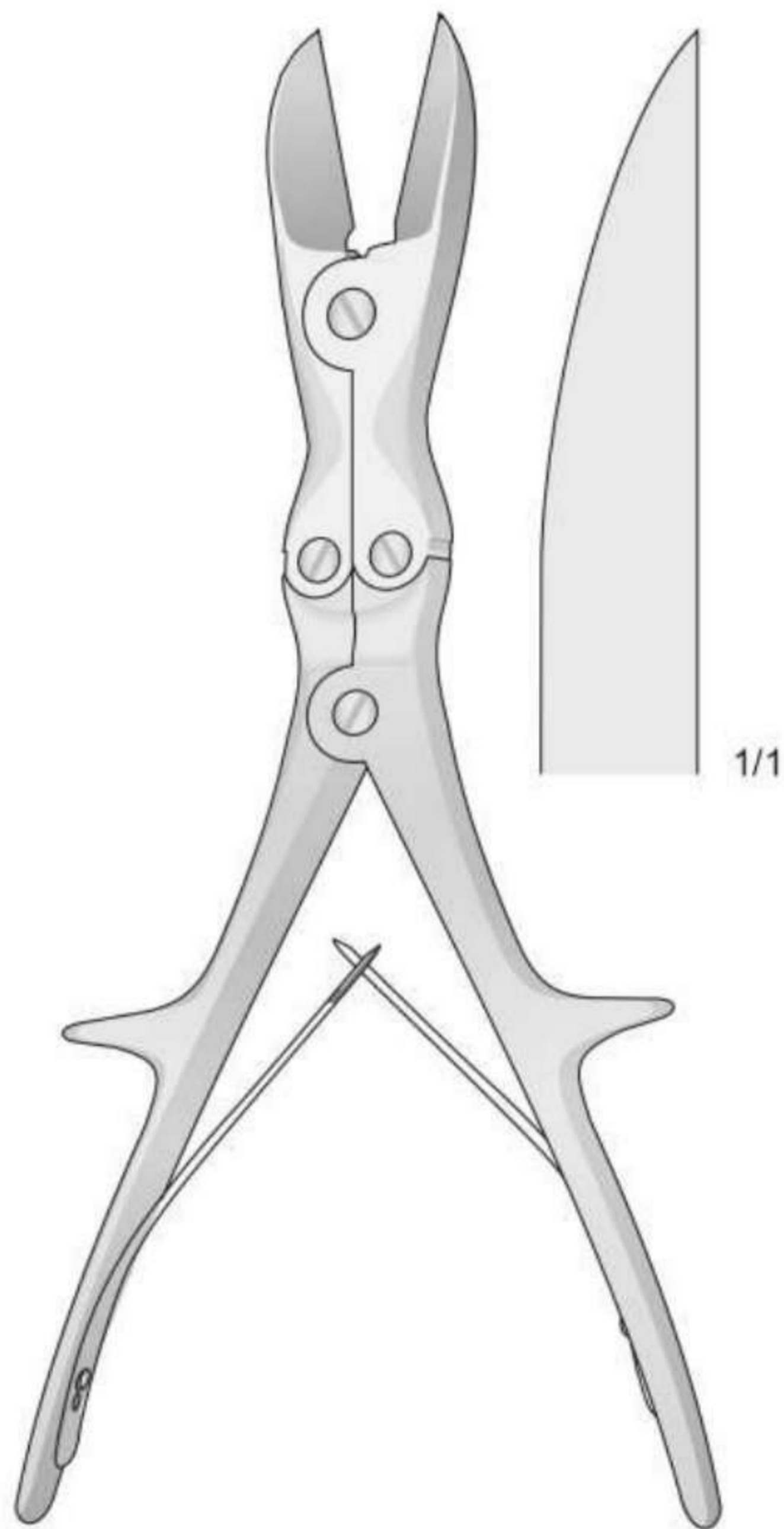

LISTON
FO-41
270 mm

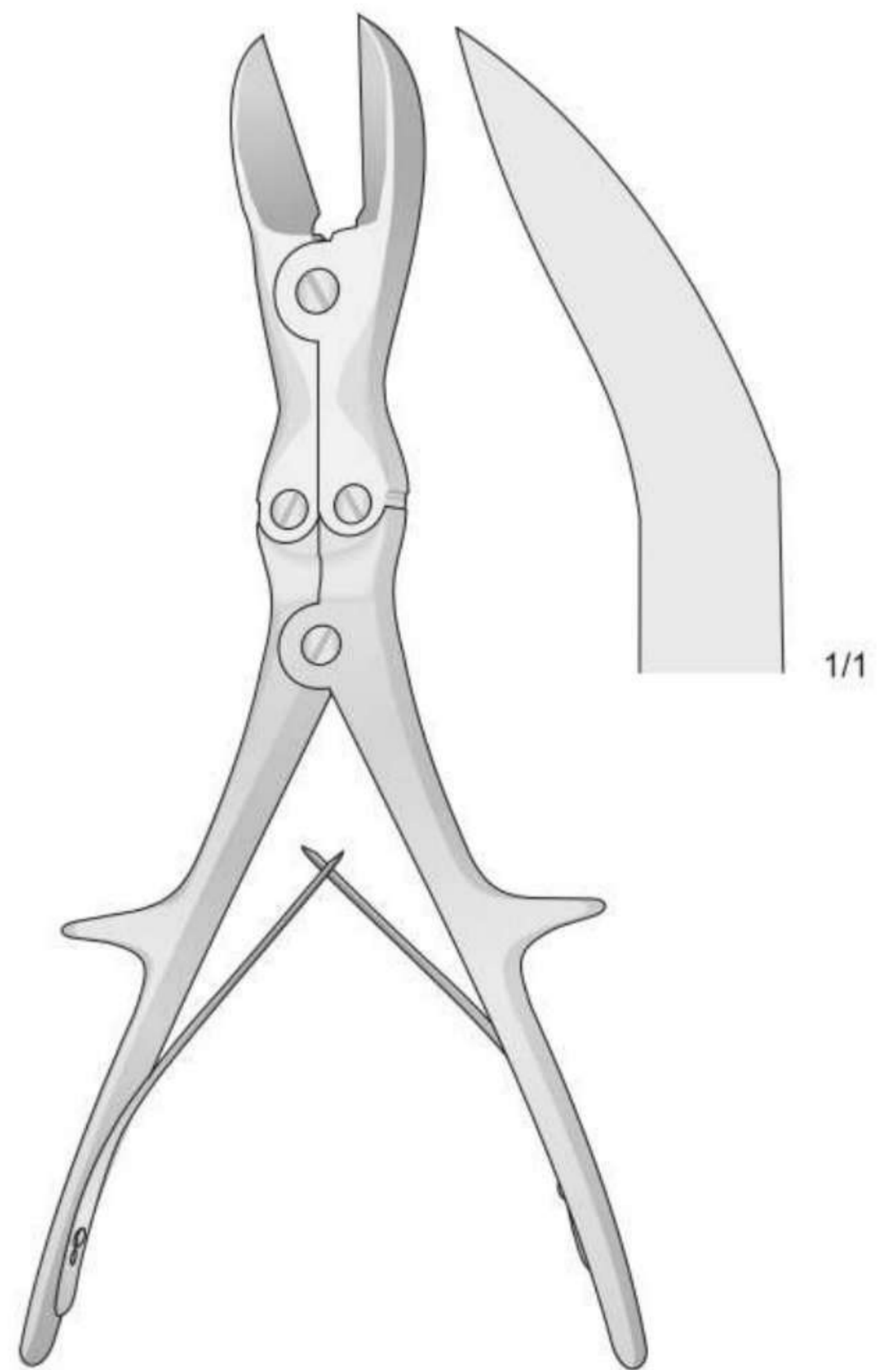

LISTON
FO-42
270 mm

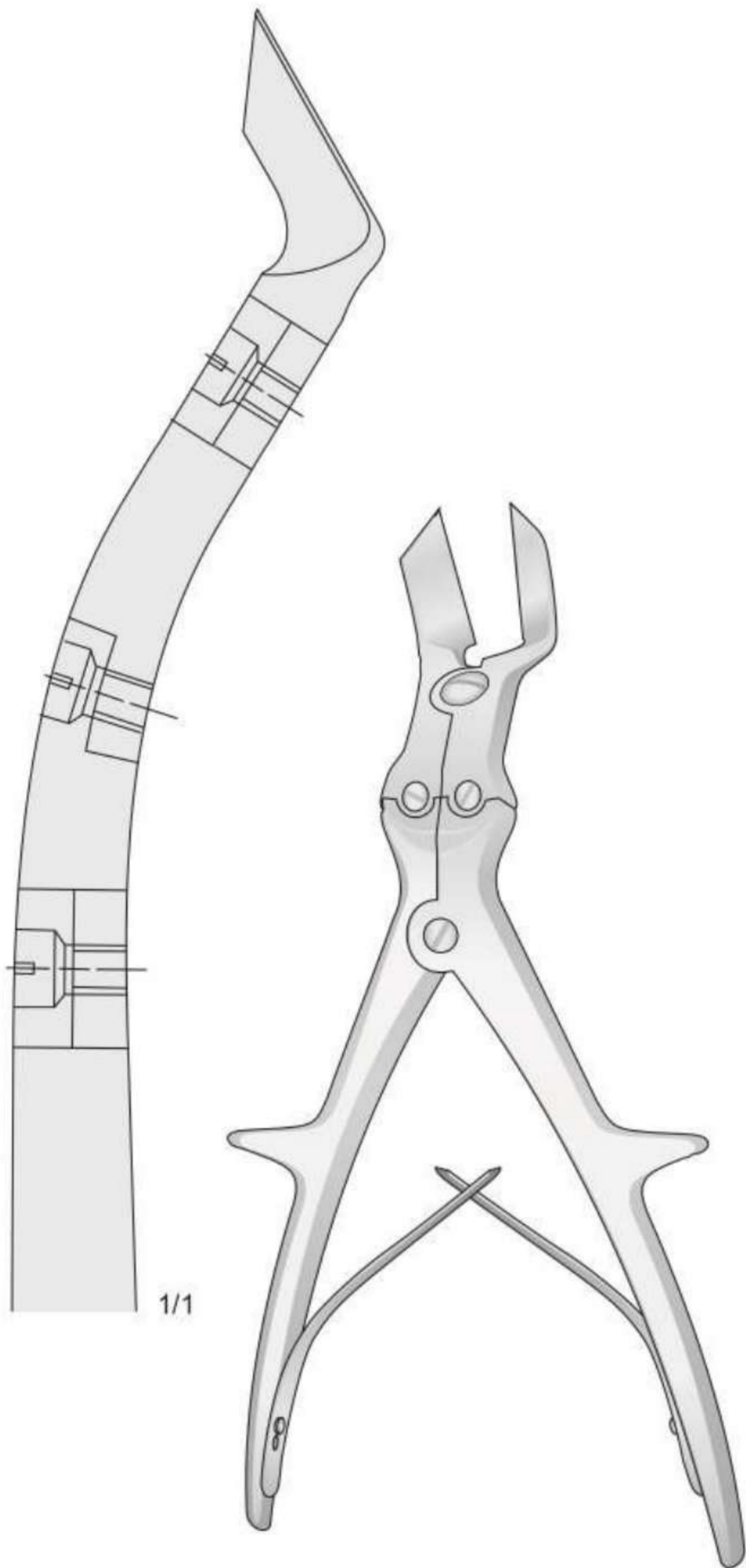

KEY-HORSLEY
FO-40
235 mm

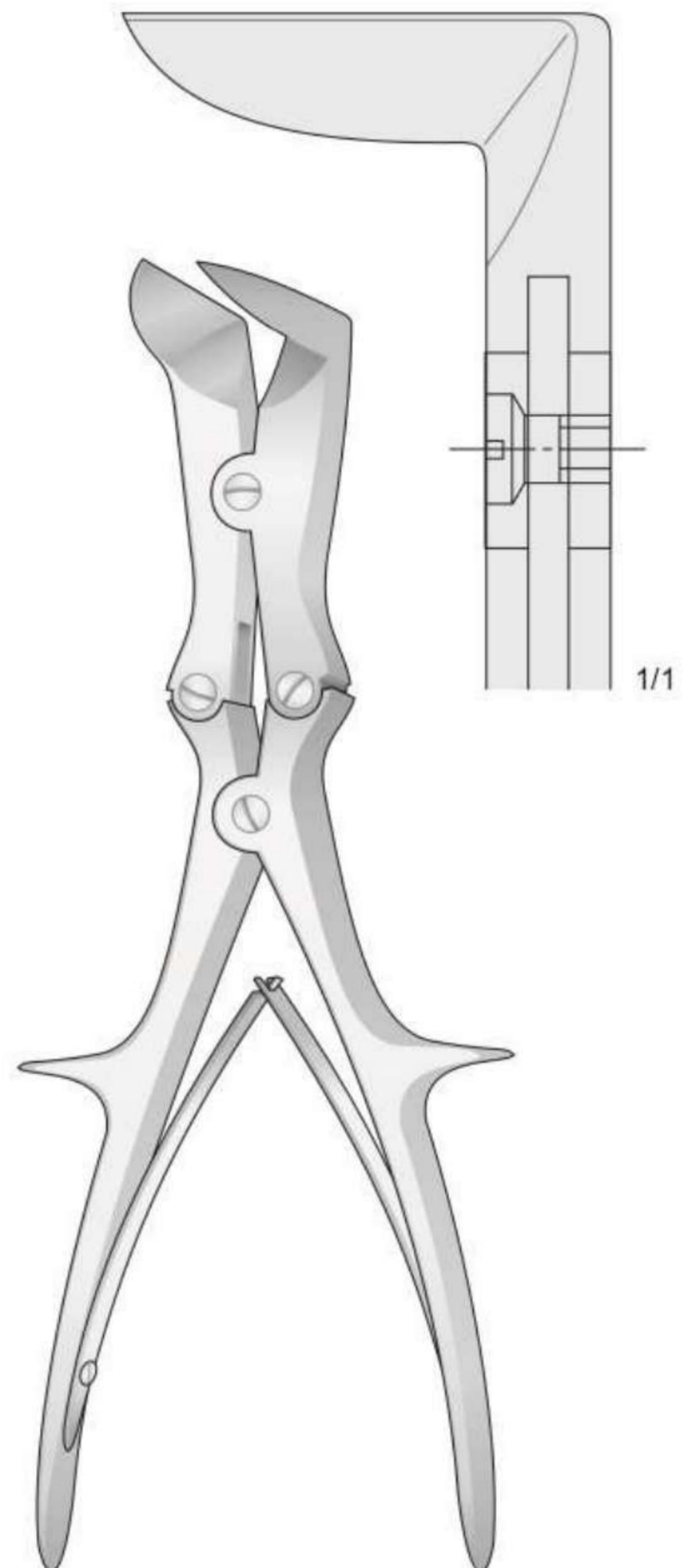

LISTON-STILLE
FO-158
265 mm

Knochensplitterscheren

Bone cutting scissors

Forbici ossivore

Tijeras para huesos

Ciseaux à os

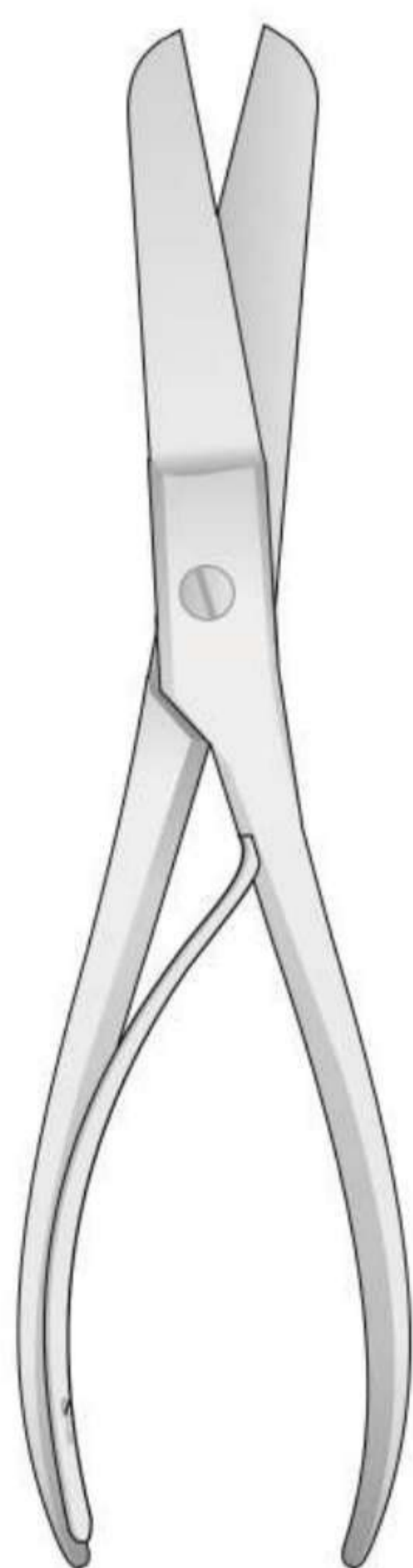

FG-40
230 mm

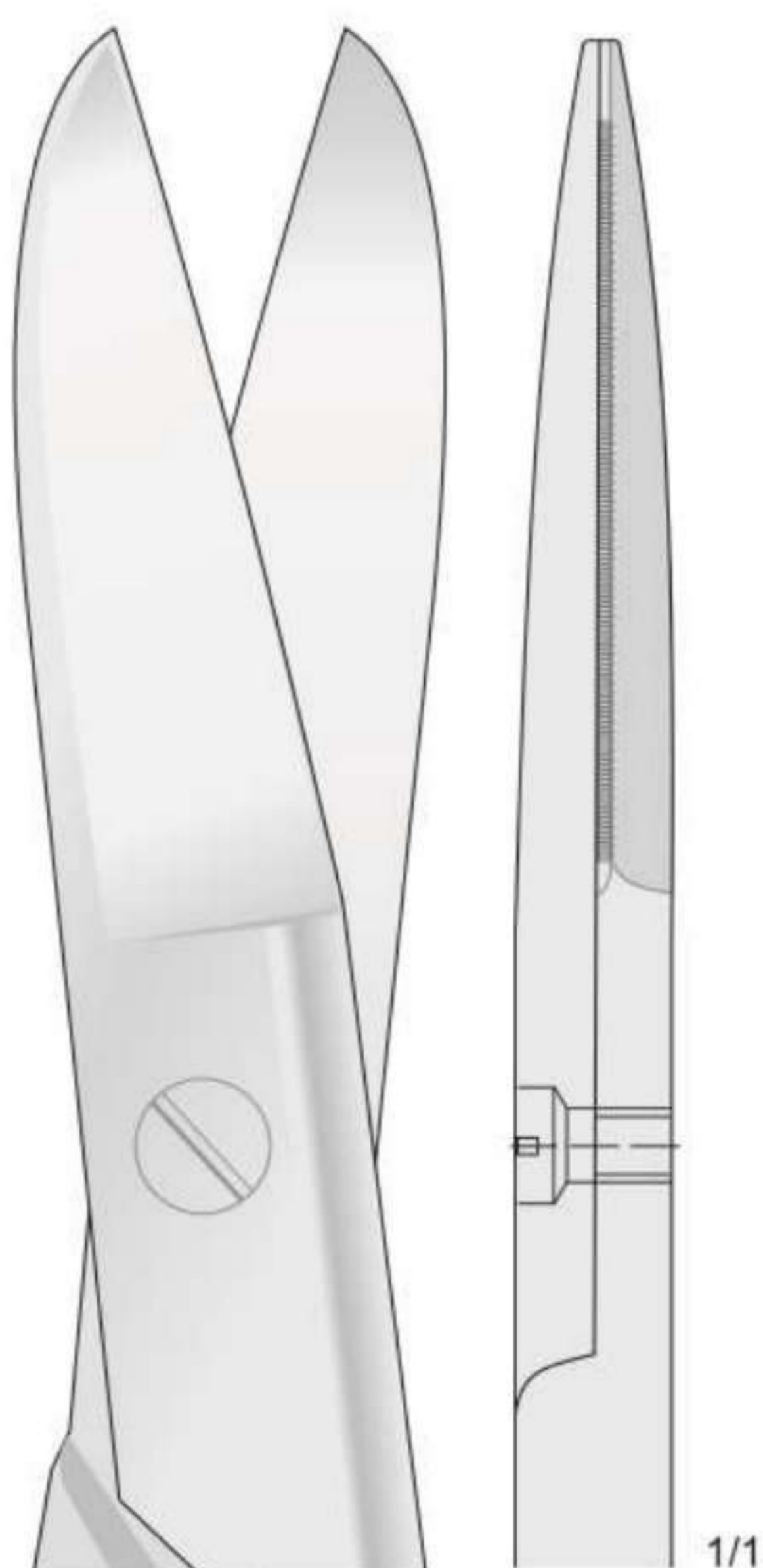

FO-63
160 mm



TRS

INSTRUMENTS

TRAUMATOLOGY

AND

ORTHOPAEDICS

Wires and Nails

Bohrdrähte und Knochennägel
Broches et clous
Agujas y clavos
Fili e chiodi

Extension Bows

Extensionsbügel
Étriers d'extension
Arcos de tracción
Archi da trazione

Twist Drills

Spiralbohrer
Forets
Brocas espirales
Maschiatori - Taps

Osteosintese

Osteosynthesis
Ostéosynthèse
Osteosintesis
Osteosintesi

Hand Drills

Handbohrapparate
Perceuses à main
Perforadores manuales
Perforatori a mano

Screwdrivers

Schraubendreher
Tournevis
Destornilladores
Cacciaviti

Bone surgery

Knochenchirurgie
Chirurgie osseuse
Cirugía ósea
Chirurgia ossea



KIRSCHNER
Trokarspitze
Trocar point
Punta trequarti
Punta de tròcar
Pointe de Trocart



KIRSCHNER
Trokarspitze
Trocar point
Punta trequarti
Punta de tròcar
Pointe de Trocart



KIRSCHNER
Lanzenspitze
Lance point
Punte lanceolate
Punta lanceolar
Pointe lancette

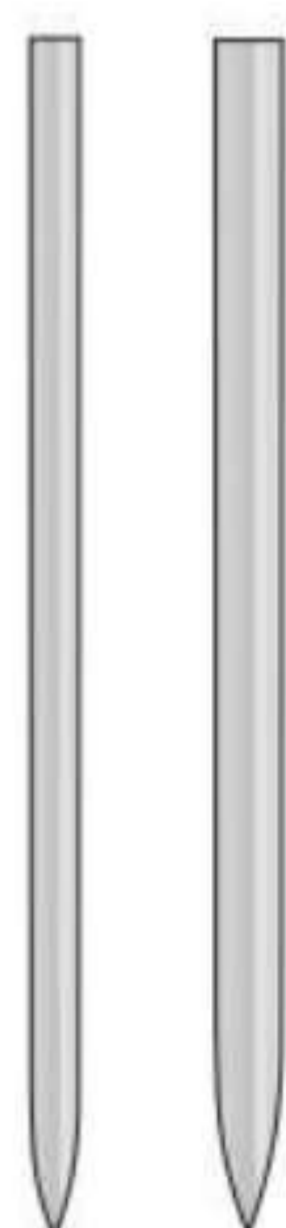

Trokarspitze
Trocar point
Punta trequarti
Punta de tròcar
Pointe de Trocart

310 mm

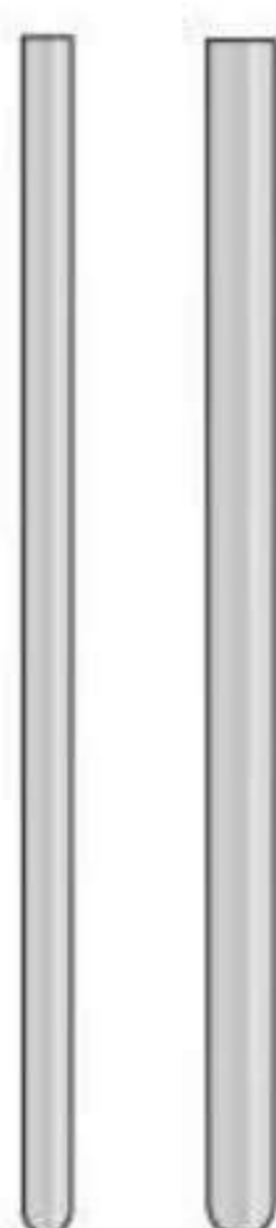

Rundes ende
Round shaft
Punta rotonda
Punta redonda
Pointe ronde

310 mm

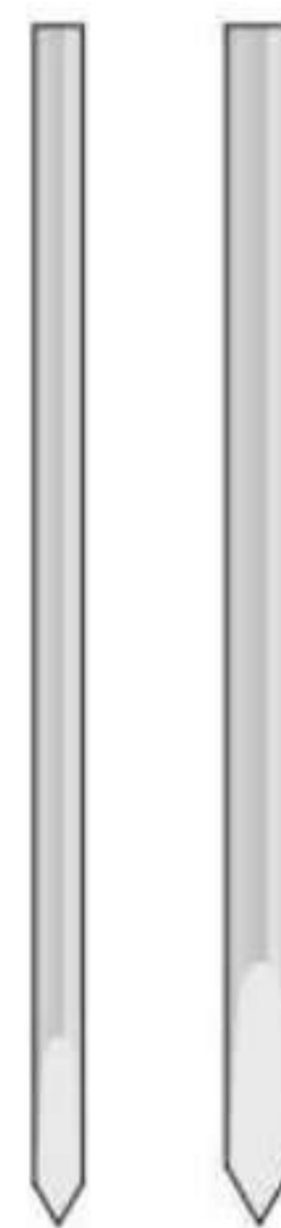

Lanzenspitze
Lance point
Punte lanceolate
Punta lanceolar
Pointe lancette

310 mm

Ø/Diam.	Conf. 10 pz.
0,8 mm	KI-99
1,0 mm	KI-100
1,2 mm	KI-102
1,4 mm	KI-114
1,5 mm	KI-115
1,6 mm	KI-116
1,7 mm	KI-117
1,8 mm	KI-118
2,0 mm	KI-120
2,2 mm	KI-122
2,5 mm	KI-125
3,0 mm	KI-130

Ø/Diam.	Conf. 10 pz.
0,8 mm	KI-00
1,0 mm	KI-01
1,2 mm	KI-02
1,4 mm	KI-14
1,5 mm	KI-15
1,6 mm	KI-16
1,7 mm	KI-17
1,8 mm	KI-18
2,0 mm	KI-20
2,2 mm	KI-22
2,5 mm	KI-25
3,0 mm	KI-30

Ø/Diam.	Conf. 10 pz.
0,8 mm	KI-40
1,0 mm	KI-41
1,2 mm	KI-42
1,5 mm	KI-43
1,6 mm	KI-44
1,8 mm	KI-45
2,0 mm	KI-46
2,2 mm	KI-47
2,5 mm	KI-48
3,0 mm	KI-49



KIRSCHNER
Trokarspitze
Trocar point
Punta trequarti
Punta de tròcar
Pointe de Trocart



KIRSCHNER
Trokarspitze
Trocar point
Punta trequarti
Punta de tròcar
Pointe de Trocart



KIRSCHNER
Lanzenspitze
Lance point
Punte lanceolate
Punta lanceolar
Pointe lancette

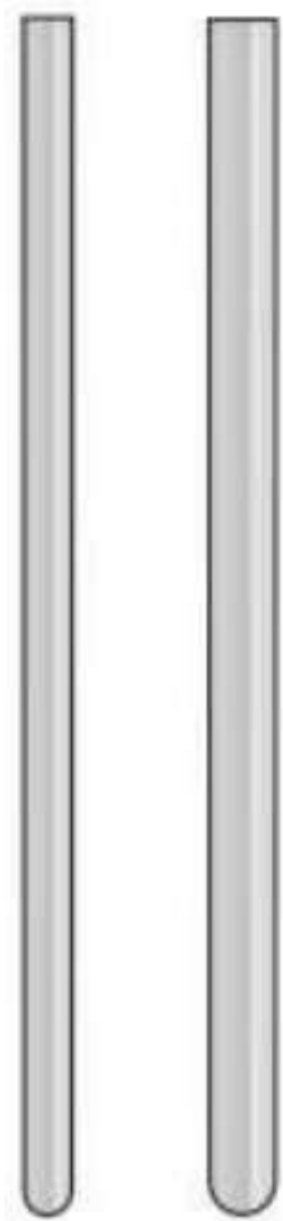

Rundes ende
Round shaft
Punta rotonda
Punta redonda
Pointe ronde

150 mm

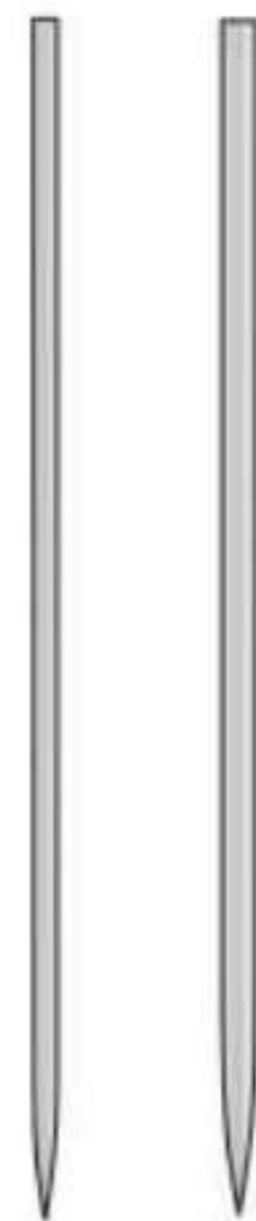

Trokarspitze
Trocar point
Punta trequarti
Punta de tròcar
Pointe de Trocart

150 mm

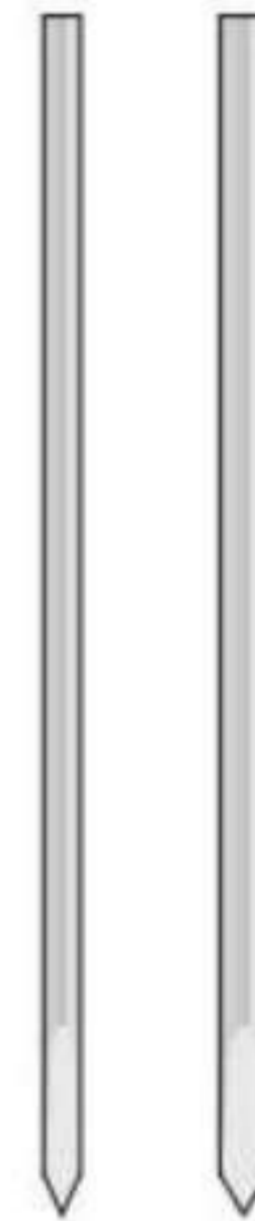

Lanzenspitze
Lance point
Punte lanceolate
Punta lanceolar
Pointe lancette

150 mm

Ø/Diam.	Conf. 10 pz.
0,8 mm	KI-69
1,0 mm	KI-70
1,2 mm	KI-72
1,4 mm	KI-74
1,5 mm	KI-75
1,6 mm	KI-76
1,7 mm	KI-77
1,8 mm	KI-78
2,0 mm	KI-80
2,2 mm	KI-82
2,5 mm	KI-85
3,0 mm	KI-90

Ø/Diam.	Conf. 10 pz.
0,8 mm	KI-60
1,0 mm	KI-61
1,2 mm	KI-62
1,4 mm	KI-63
1,6 mm	KI-64
1,8 mm	KI-65
2,0 mm	KI-66
2,2 mm	KI-67
2,5 mm	KI-68
3,0 mm	KI-71

Ø/Diam.	Conf. 10 pz.
0,8 mm	KI-29
1,0 mm	KI-31
1,2 mm	KI-32
1,5 mm	KI-33
1,6 mm	KI-34
1,8 mm	KI-35
2,0 mm	KI-36
2,2 mm	KI-37
2,5 mm	KI-38
3,0 mm	KI-39

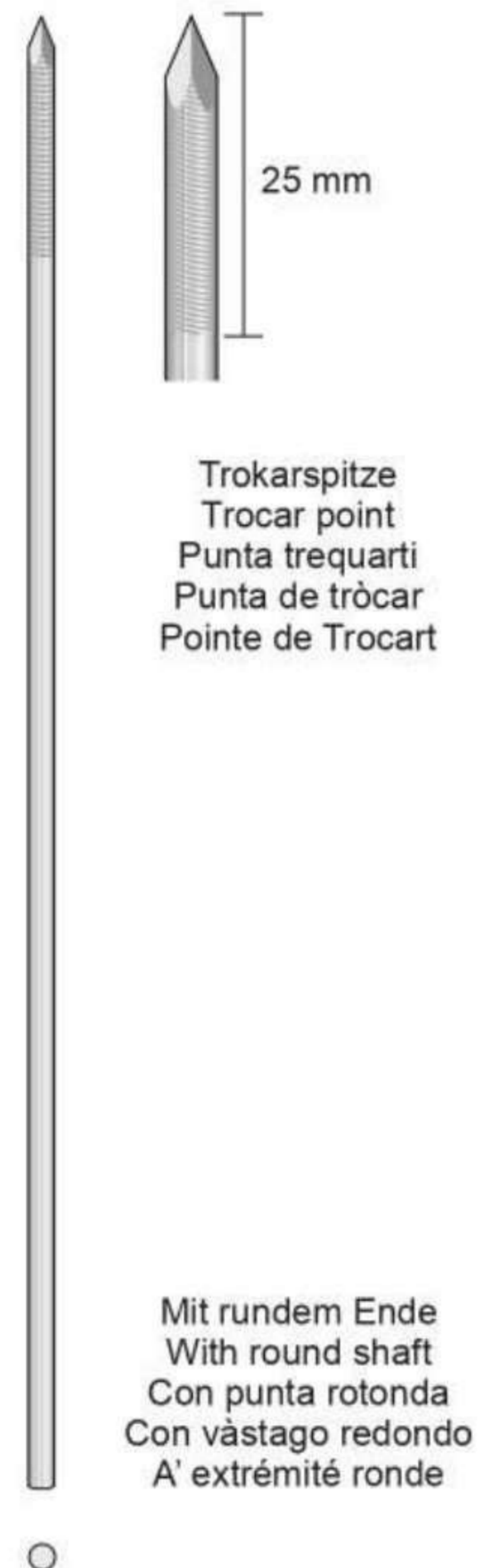
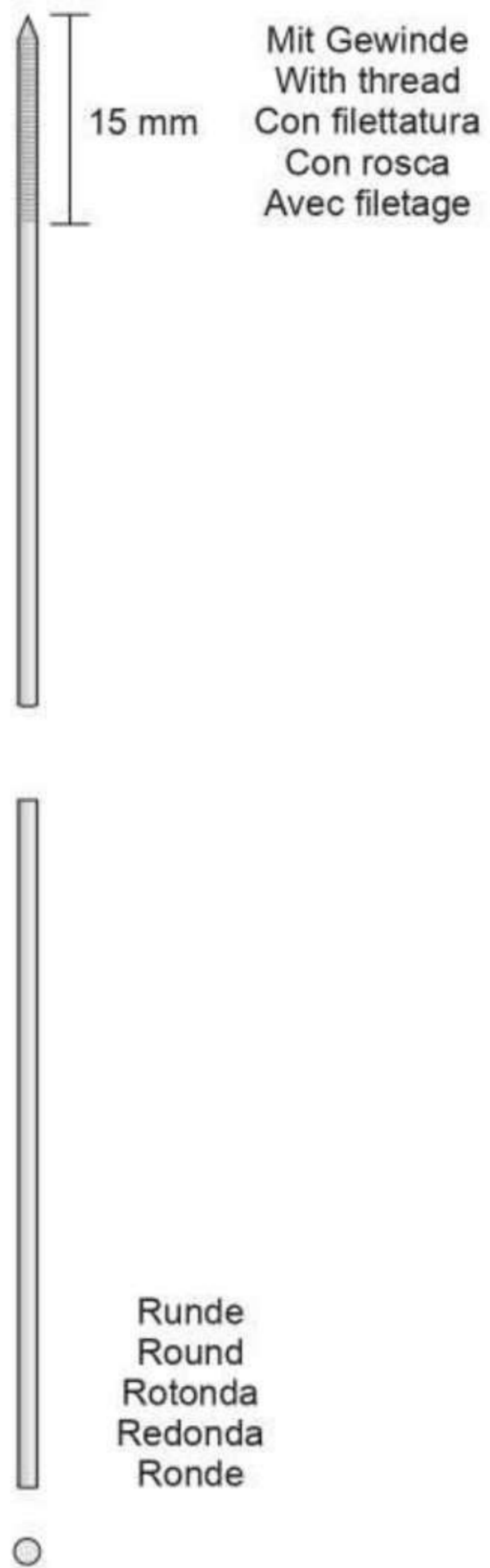

KIRSCHNER			
Codice	Ø mm	Lung.	Lung. filo
KI-220	1,5	150	5
KI-221	1,6	150	15
KI-222	2	150	15
KI-223	2	200	15

KIRSCHNER			
Codice	Ø mm	Lung.	Lung. filo
KI-224	2,5	200	25
KI-225	2,5	230	25
KI-226	2,5	300	25
KI-227	3,0	300	25
KI-228	3,5	300	25
KI-229	4,0	260	25
KI-233	4,5	300	25

KIRSCHNER

Bundel-Nagel



500 mm

Steinmann pins



310 mm

Küntscher



400 mm

Threaded Steinmann Pins



Runde



230 mm

Ø/Diam.	Conf. 10 pz.
2,0 mm	KI-50
2,5 mm	KI-51
3,0 mm	KI-52
3,5 mm	KI-53
4,0 mm	KI-54
4,5 mm	KI-55
5,0 mm	KI-56
5,5 mm	KI-57
6,0 mm	KI-58

Ø/Diam.	Conf. 1 pz.
3,5 mm	KI-280
4,0 mm	KI-282
4,5 mm	KI-284
5,0 mm	KI-286
6,0 mm	KI-288
6,5 mm	KI-290

Ø/Diam.	Conf. 1 pz.
6,0 mm	KI-252
7,0 mm	KI-254
8,0 mm	KI-256
9,0 mm	KI-258
10 mm	KI-260
11 mm	KI-262
12 mm	KI-264

Ø/Diam.	Conf. 1 pz.
2,0 mm	KI-160
2,5 mm	KI-161

Negativo

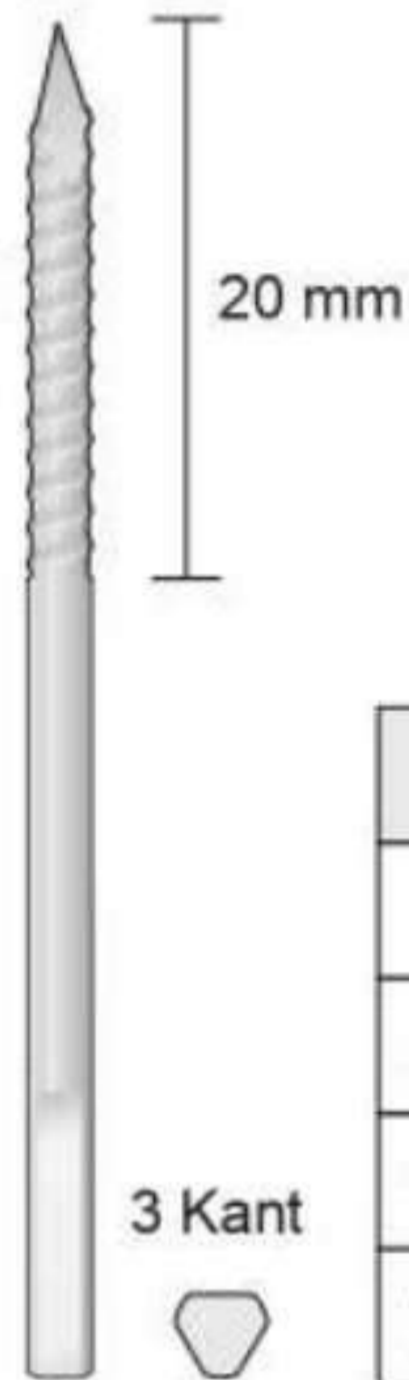

SCHANZ			
Codice	Ø mm	Lung.	Lung. filo
KI-230	3	60	20
KI-231	3	80	20
KI-232	4	60	25

3 Kant



Negativo

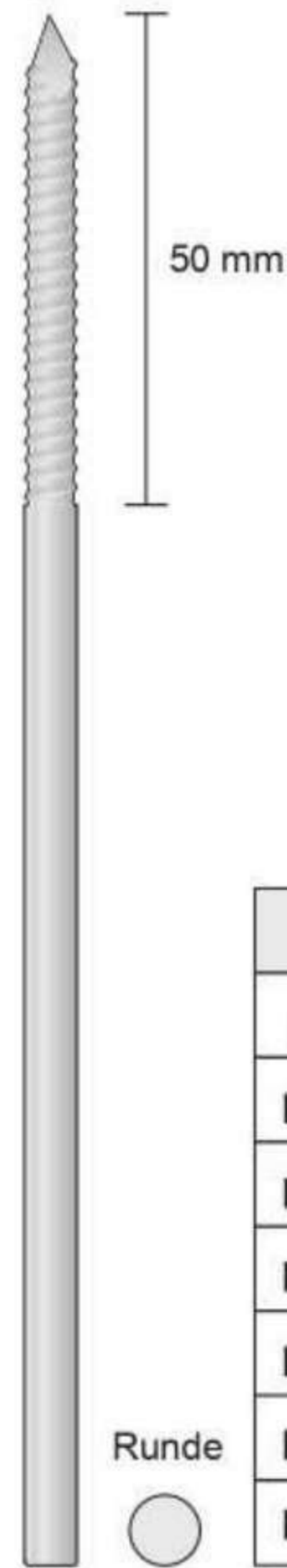

SCHANZ			
Codice	Ø mm	Lung.	Lung. filo
KI-293	2	150	50
KI-294	3	150	50
KI-295	3,5	150	50
KI-296	4	150	50
KI-297	4,5	150	50
KI-298	5	150	50

Runde



Negativo

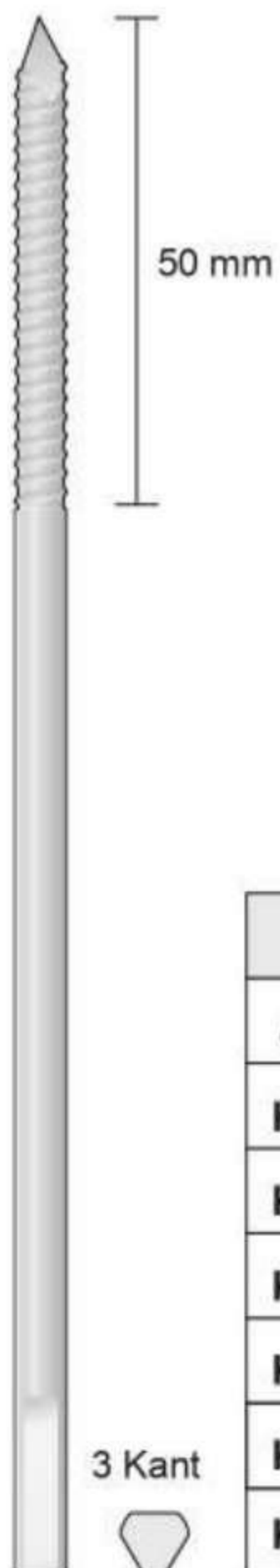

SCHANZ			
Codice	Ø mm	Lung.	Lung. filo
KI-238	2	150	50
KI-240	3	150	50
KI-242	3,5	150	50
KI-244	4	150	50
KI-246	4,5	150	50
KI-248	5	150	50

3 Kant



Positivo

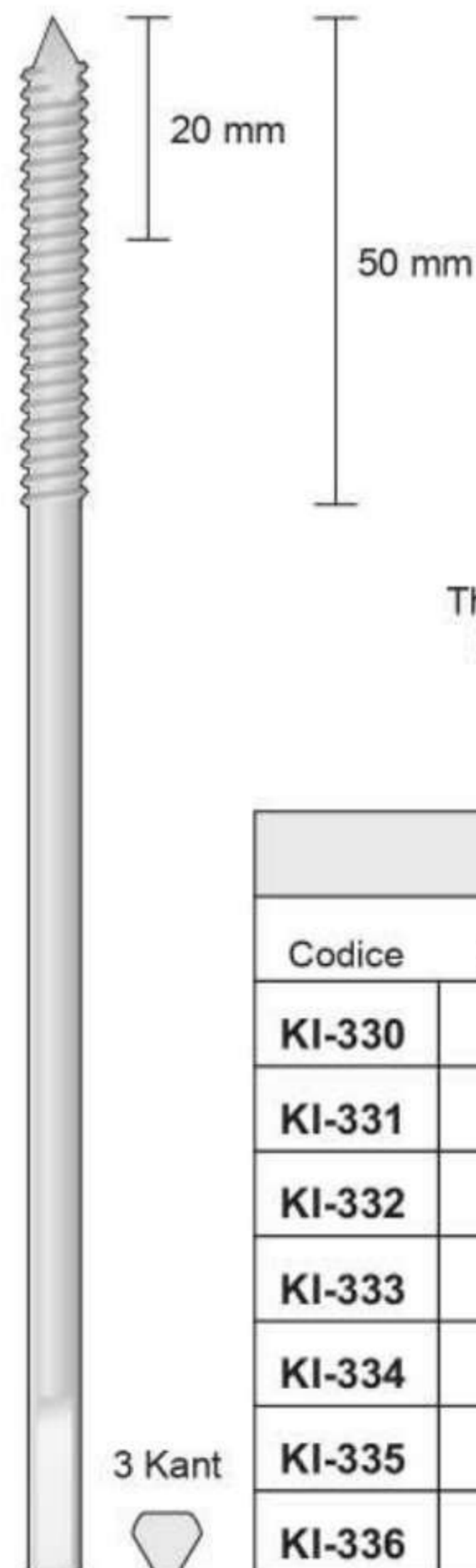

Thread - Ø is 0,5 mm
more than pin - Ø

SCHANZ			
Codice	Ø mm	Lung.	Lung. filo
KI-330	2	150	20
KI-331	3	150	20
KI-332	3,5	150	50
KI-333	4	150	25
KI-334	4	150	50
KI-335	4,5	150	50
KI-336	5	150	50

3 Kant



Steinmann Pins with Central Thread with Trocar Point

Bohrdrahtspender
Contentitore per
sterilizzazione Kirschner

Positivo
Thread - Ø is 0,5 mm
more than pin - Ø



3 Kant



STEINMANN PINS		
Codice	Ø mm	Lung.
KI-175	3	150
KI-176	3	180
KI-177	3	200
KI-178	3	230
KI-179	3,5	150
KI-180	3,5	180
KI-181	3,5	200
KI-182	3,5	230
KI-183	4	150
KI-184	4	180
KI-185	4	200
KI-186	4	230
KI-187	4	250
KI-188	4,5	150
KI-189	4,5	180
KI-190	4,5	200
KI-191	4,5	230
KI-192	4,5	250
KI-193	4,5	300
KI-194	5	150
KI-195	5	180
KI-196	5	200
KI-197	5	230
KI-198	5	250
KI-199	5	300

Ø 10 mm



KI-300
320 mm
KI-301
190 mm

Bis Ø 3 mm
Up to Ø 3 mm
Fino a Ø 3 mm

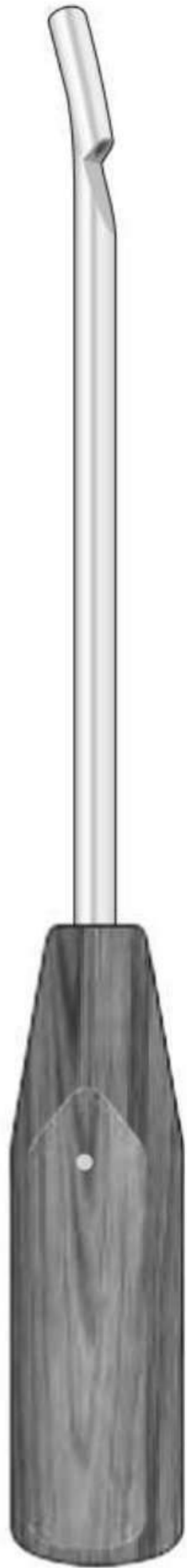

WAGNER
LS-106
300 mm

Extraktionshaken
Extraction hooks
Gancio d'estrazione
Ganchos extractores
Crochets d'extraction

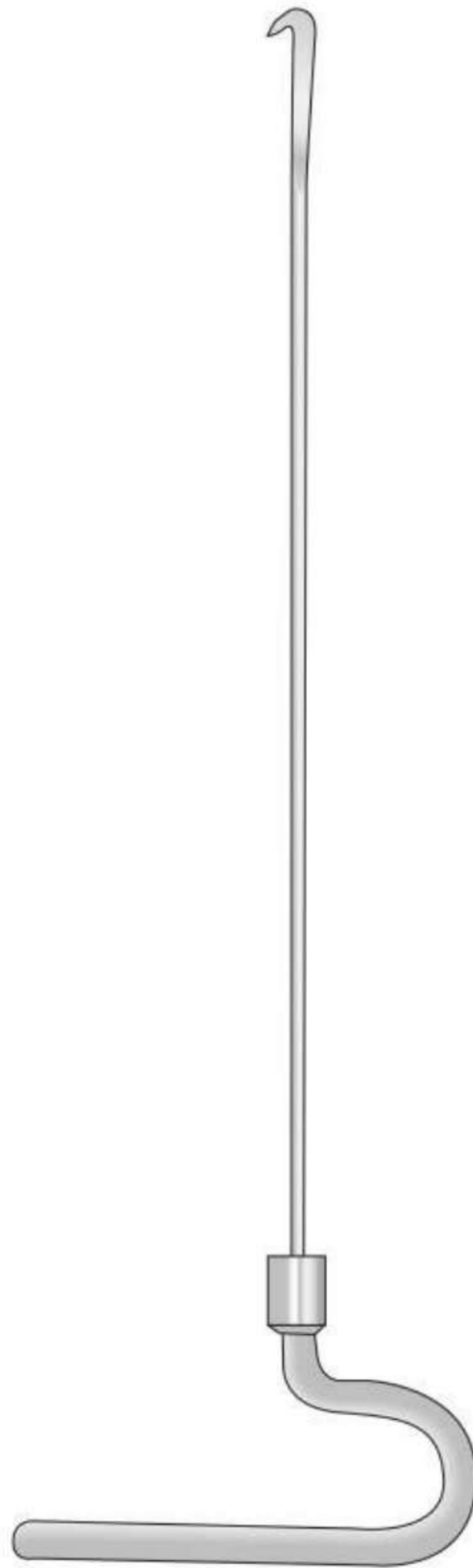

KI-306 - 290 mm
KI-307 - 370 mm
KI-308 - 420 mm

Ø Int. 2,5 mm



LS-100
120 mm

Ø Int. 1,2 mm



KÜNTSCHER
FK-09
210 mm

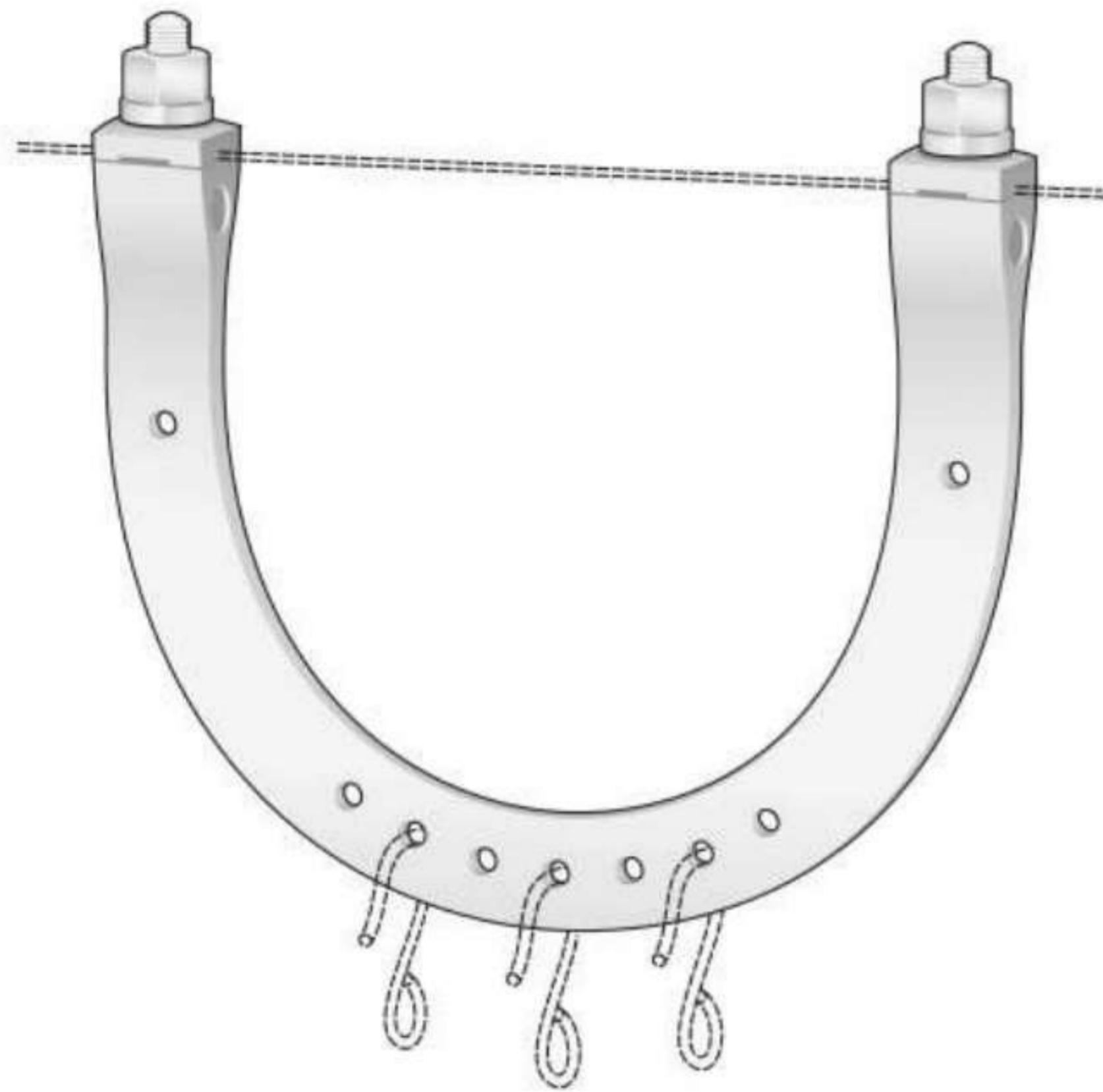

KIRSCHNER
LS-370/LS-378

- LS-370 200 x 155 mm
- LS-371 155 x 155 mm
- LS-372 155 x 100 mm
- LS-373 135 x 130 mm
- LS-374 120 x 120 mm
- LS-375 105 x 100 mm
- LS-376 95 x 110 mm
- LS-377 105 x 80 mm
- LS-378 95 x 70 mm

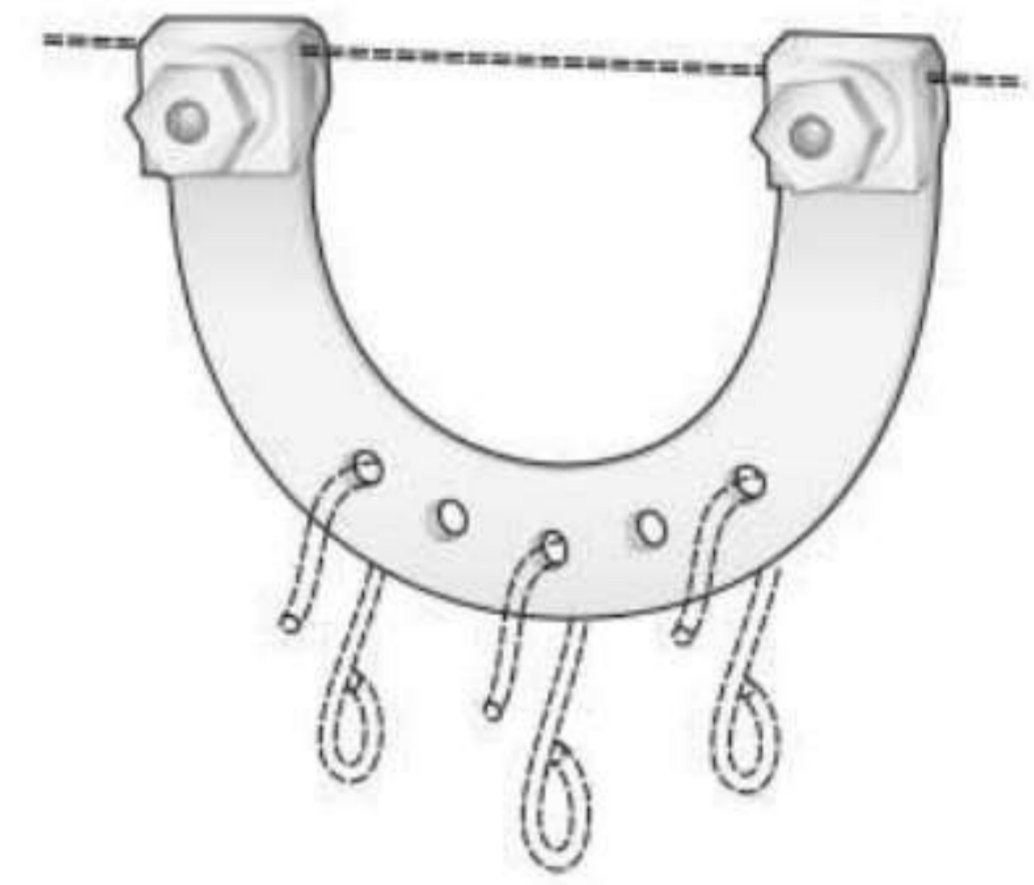

KIRSCHNER
LS-379
60 x 50 mm

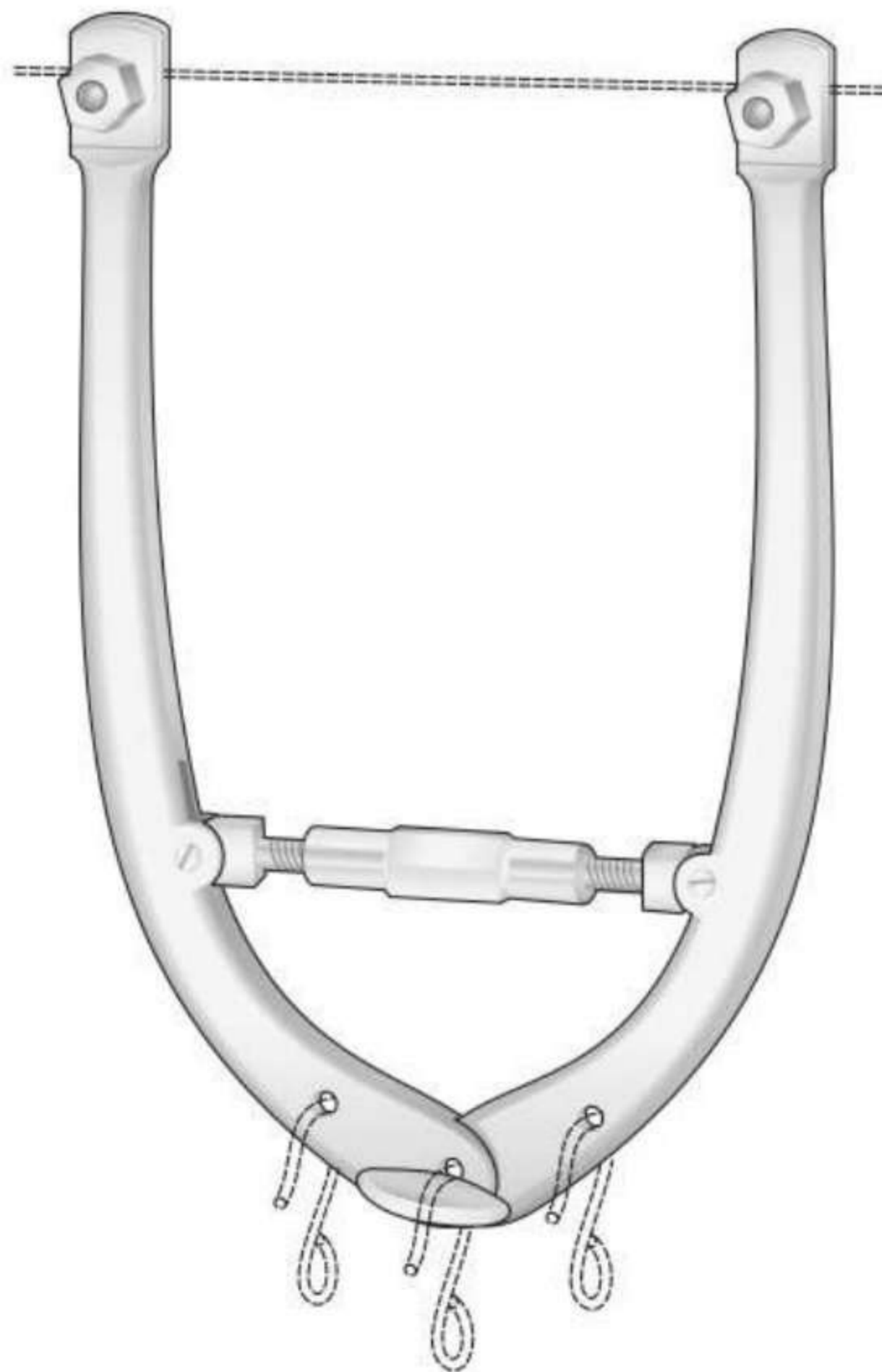

LS-380 180 x 100 mm
LS-381 270 x 160 mm



LS-382



LS-383



LS-384

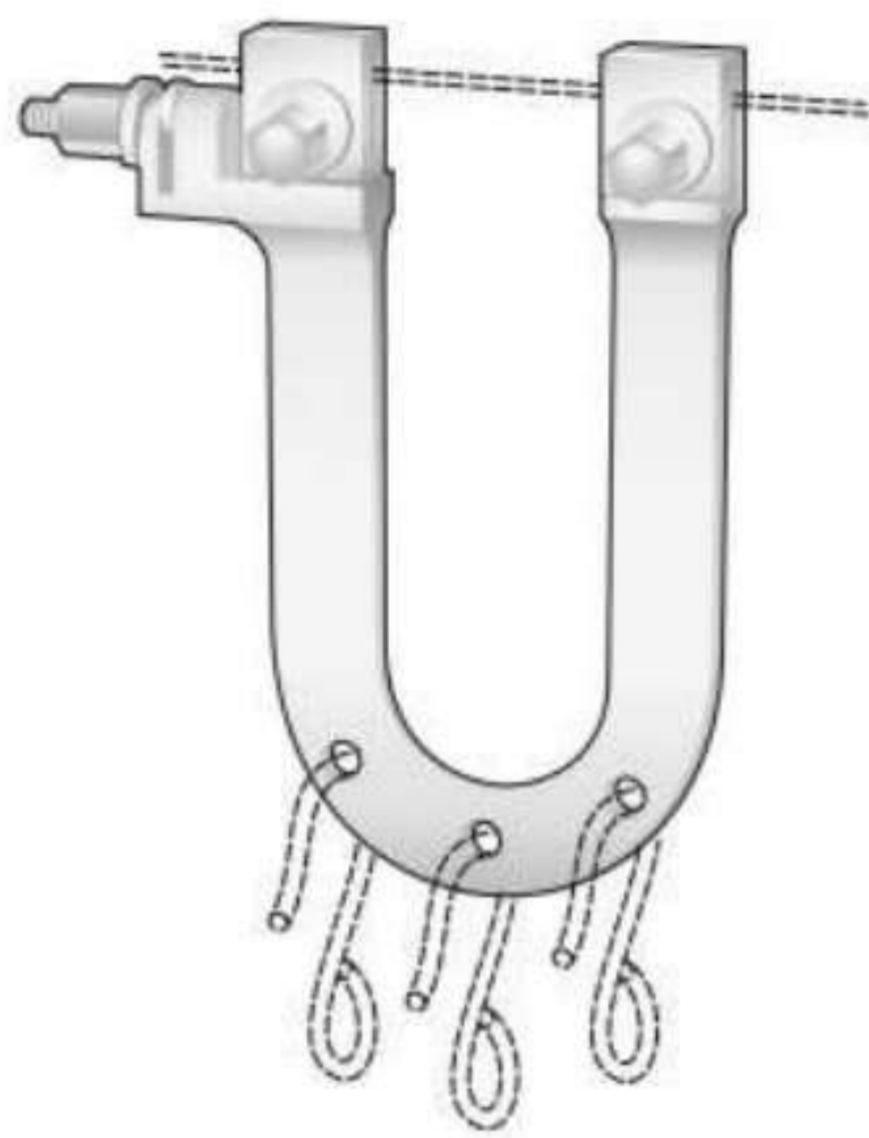

LS-385
30 x 80 mm

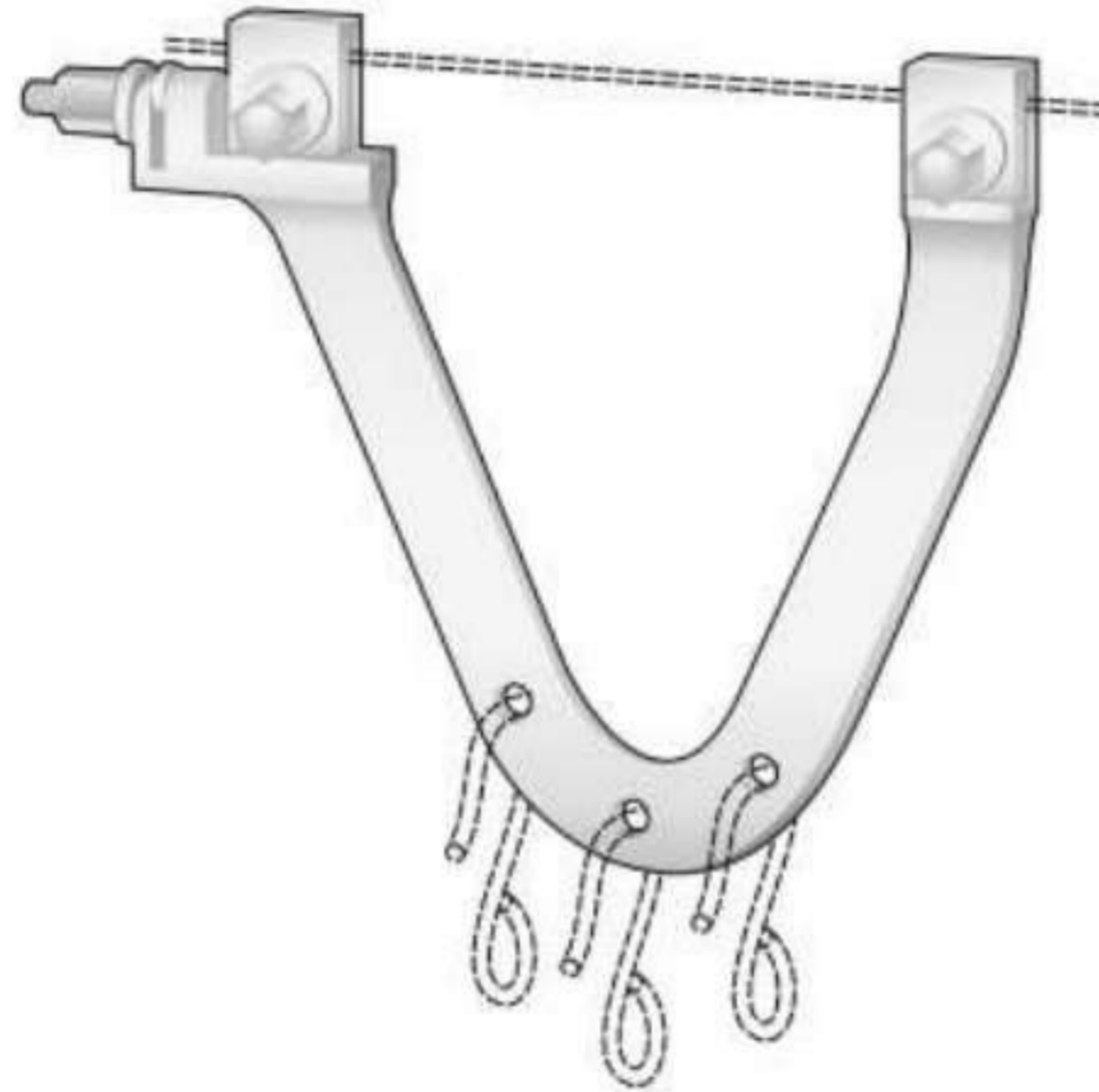

LS-386
60 x 70 mm

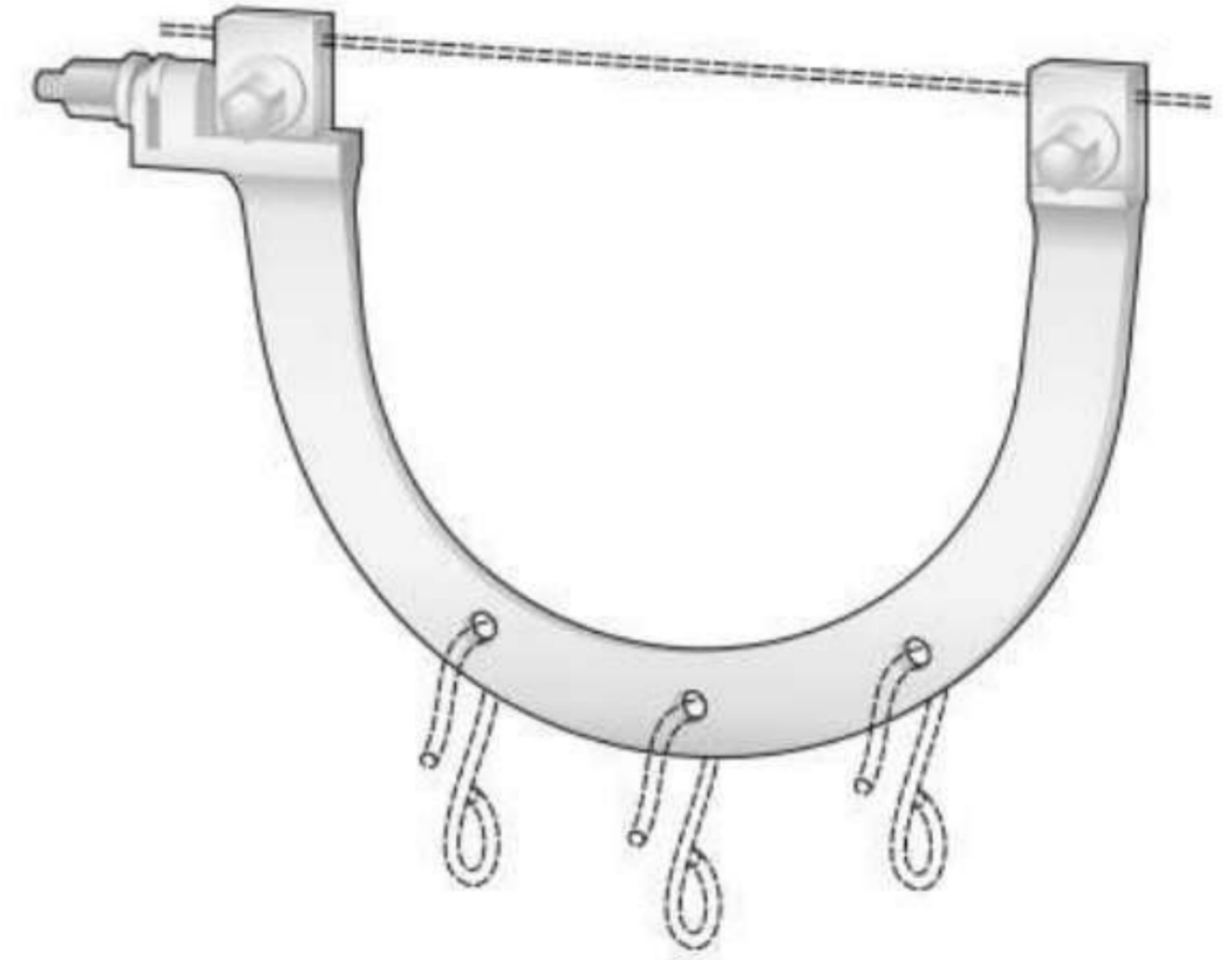

LS-387
105 x 80 mm

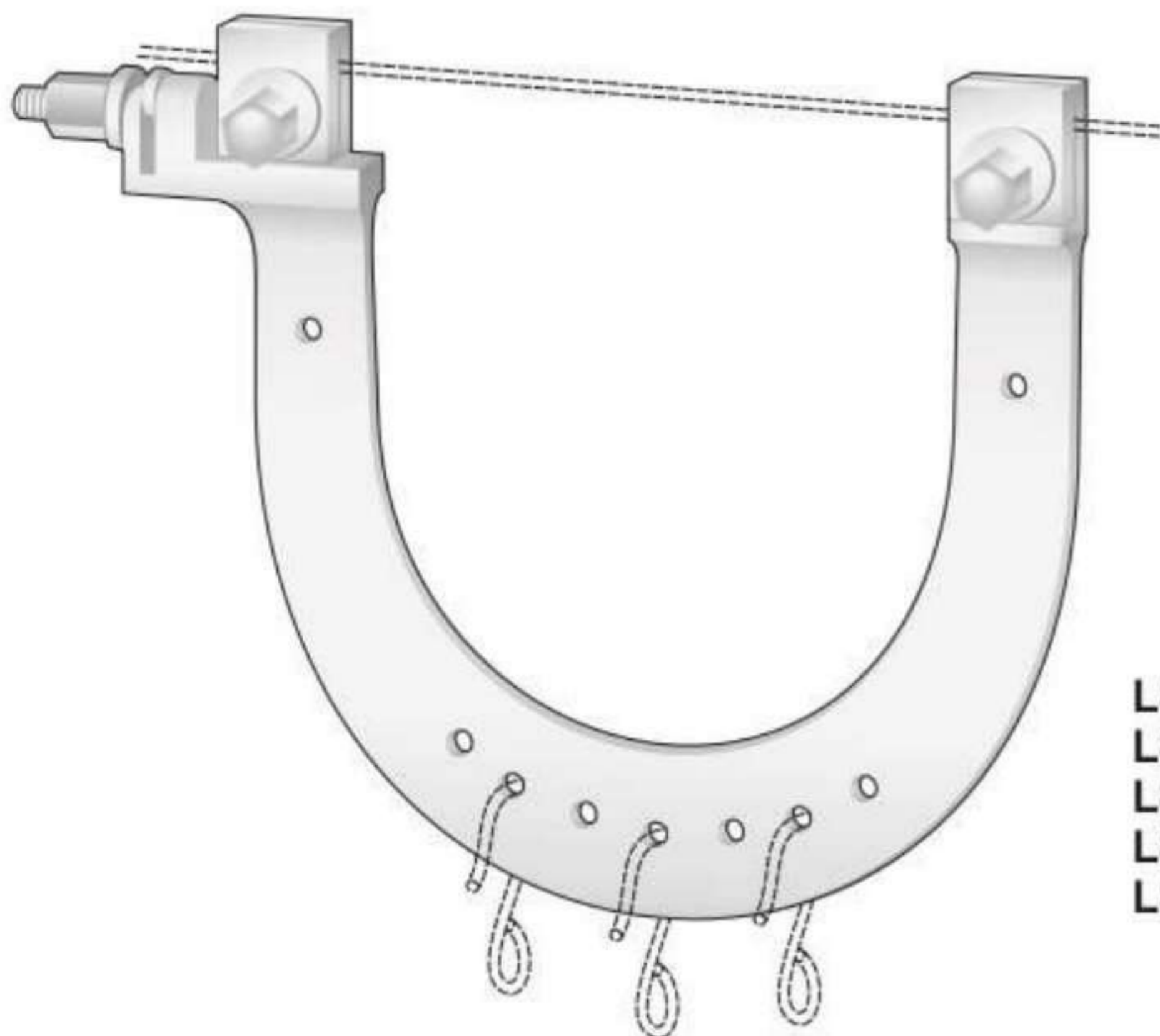

LS-390/LS-394

- LS-390** 95 x 155 mm
- LS-391** 120 x 115 mm
- LS-392** 135 x 125 mm
- LS-393** 155 x 140 mm
- LS-394** 200 x 140 mm



LS-388/LS-389

Spiralbohrer

Twist drills

Maschiatori - Taps

Brocas espirales

Forets

Dental schaft
Attacco Dentale

Ø 1,5 mm



LS-32
50 mm

Ø 2,0 mm



LS-33
55 mm

Mit AO schaft
Attacco AO

Ø 1,5 mm



LS-10
65 mm

Ø 2 mm



LS-11
70 mm

Ø 2,7 mm



LS-12
100 mm

Passo della vite
a 1,25 mm

Ø 3,5 mm



LS-13
110 mm

Passo della vite
a 1,75 mm

Ø 3,5 mm



LS-14
110 mm

Ø 4,5 mm



LS-15
130 mm

Ø 4,5 mm



LS-16
130 mm

Ø 6,5 mm



LS-17
170 mm

Spiralbohrer

Twist drills

Maschiatori - Taps

Brocas espirales

Forets

Mit AO schaft
Drill bits
Attacco AO

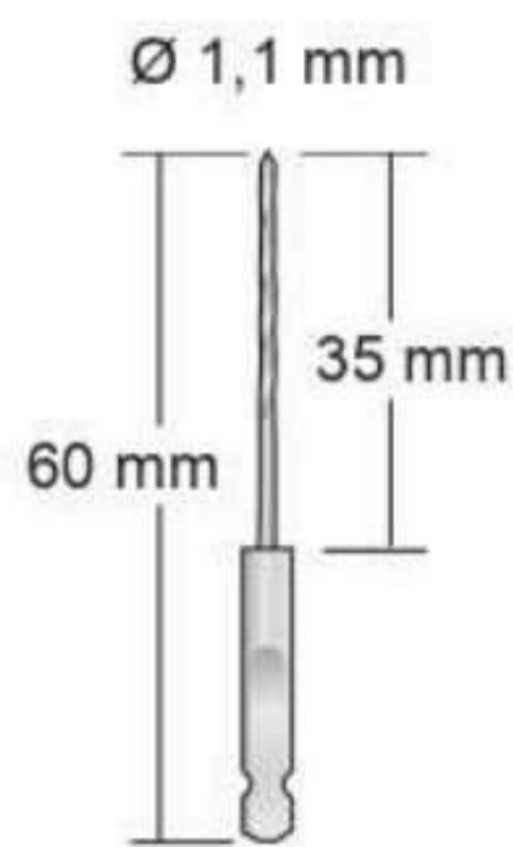

LS-20

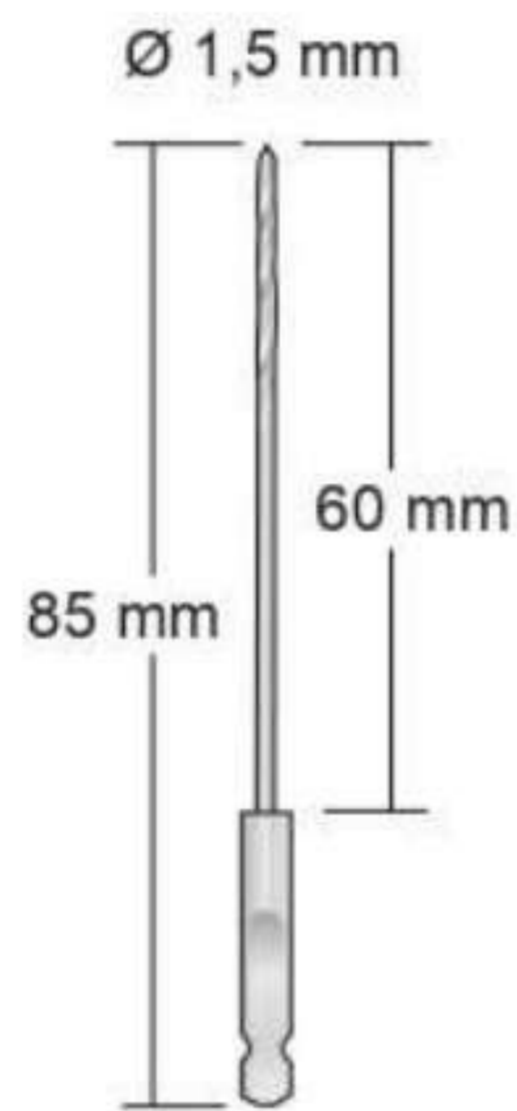

LS-21

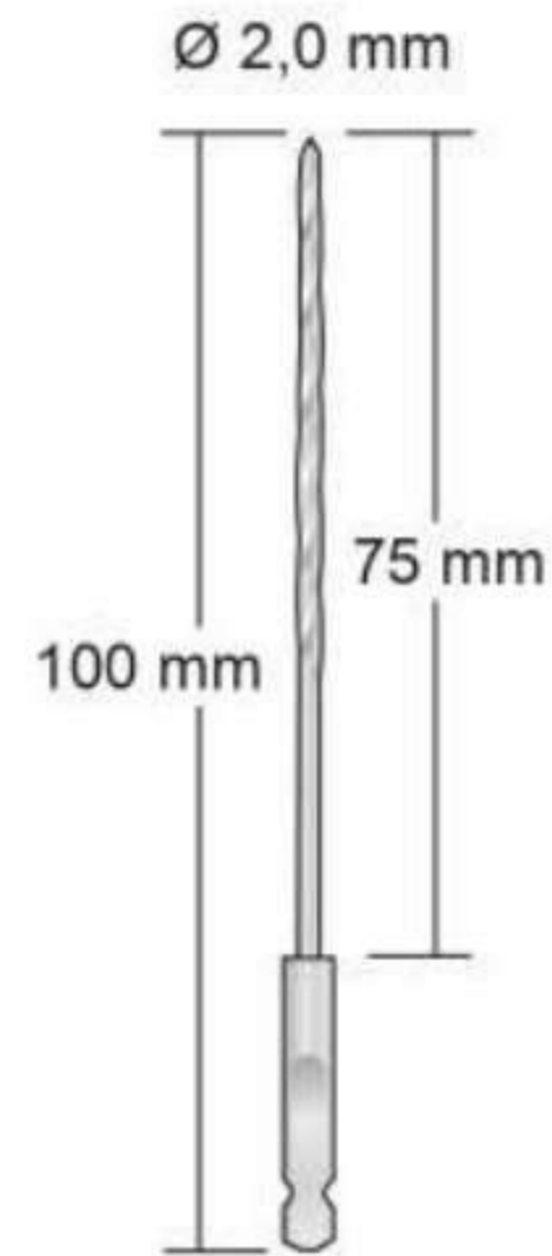

LS-22

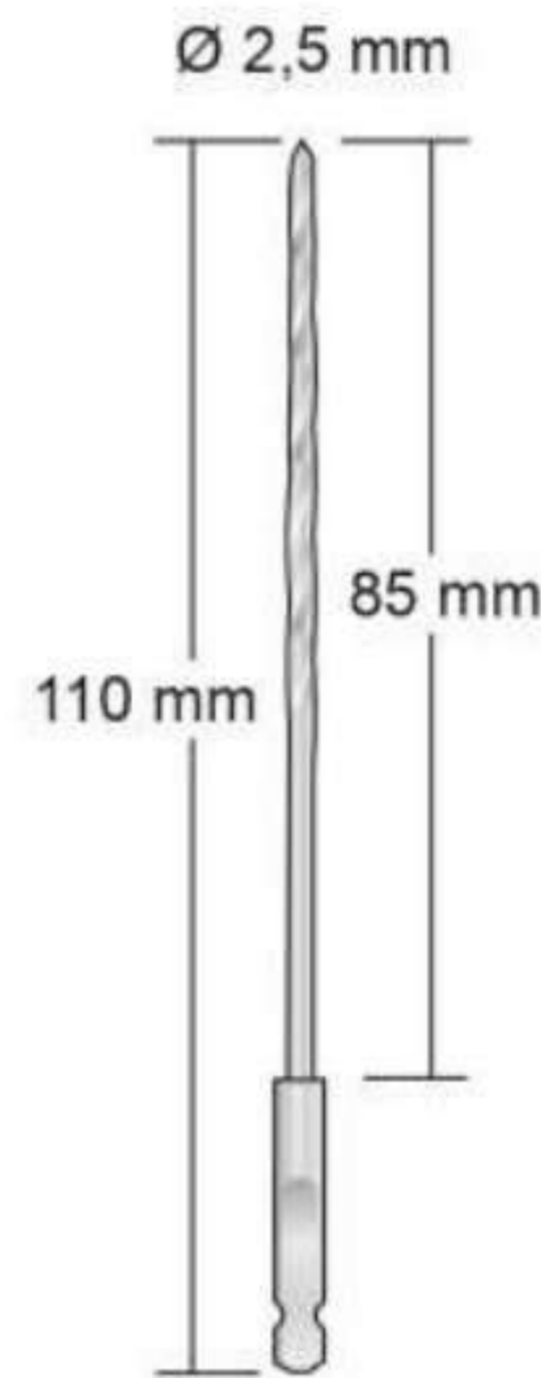

LS-23

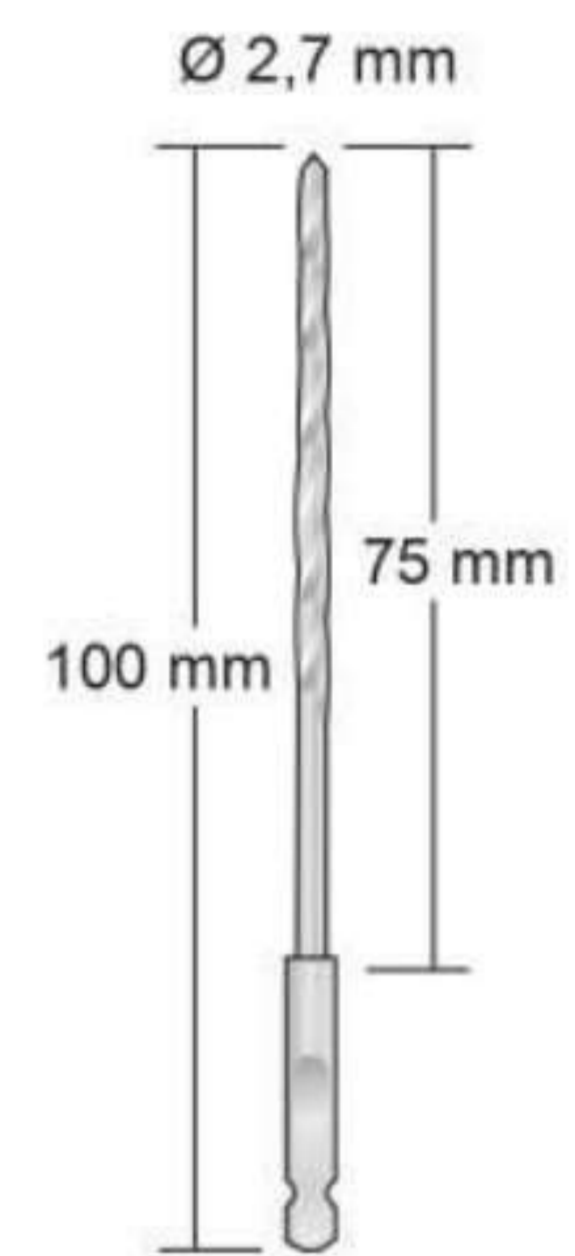

LS-24

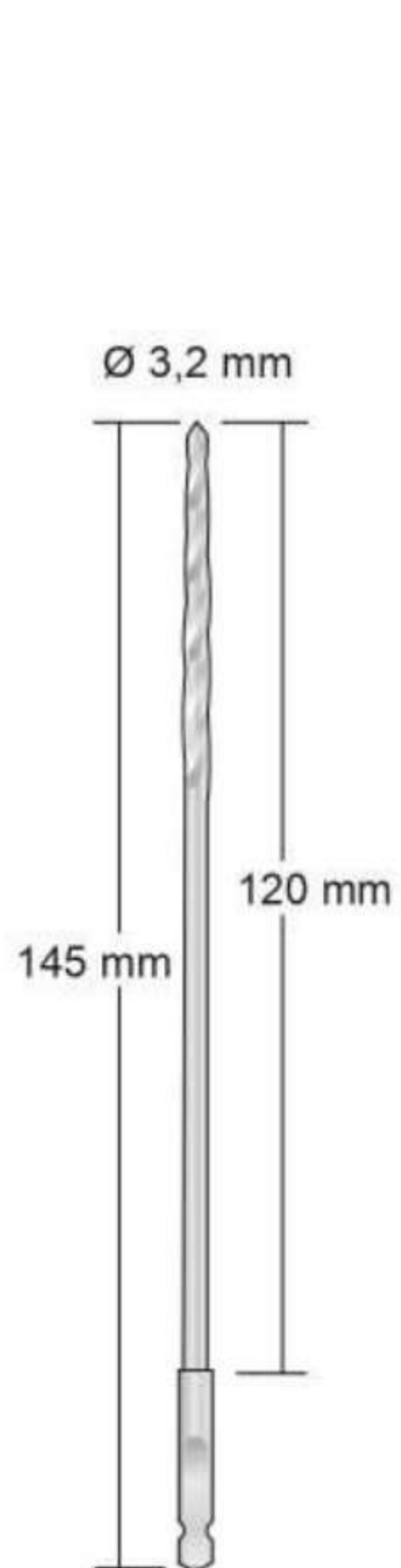

LS-25

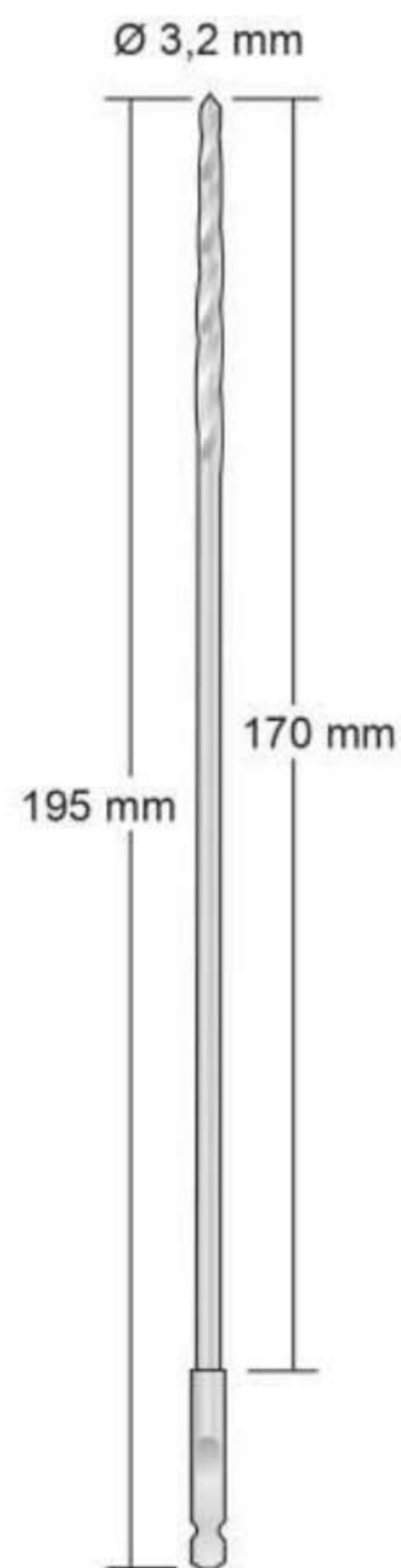

LS-26

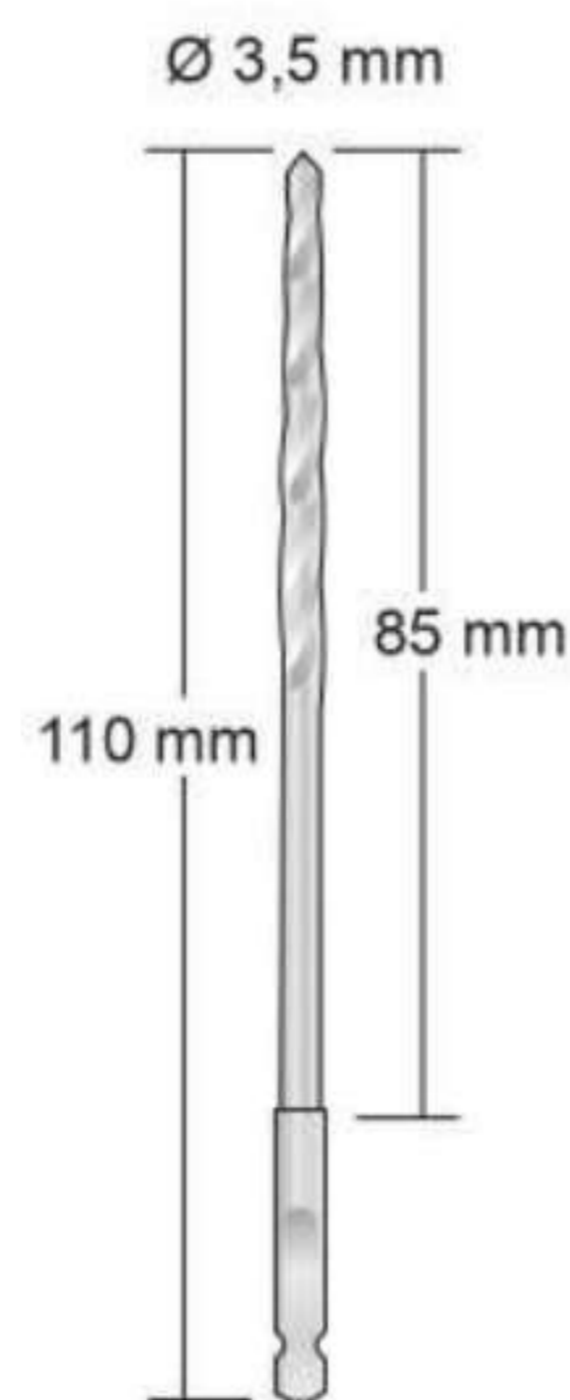

LS-27

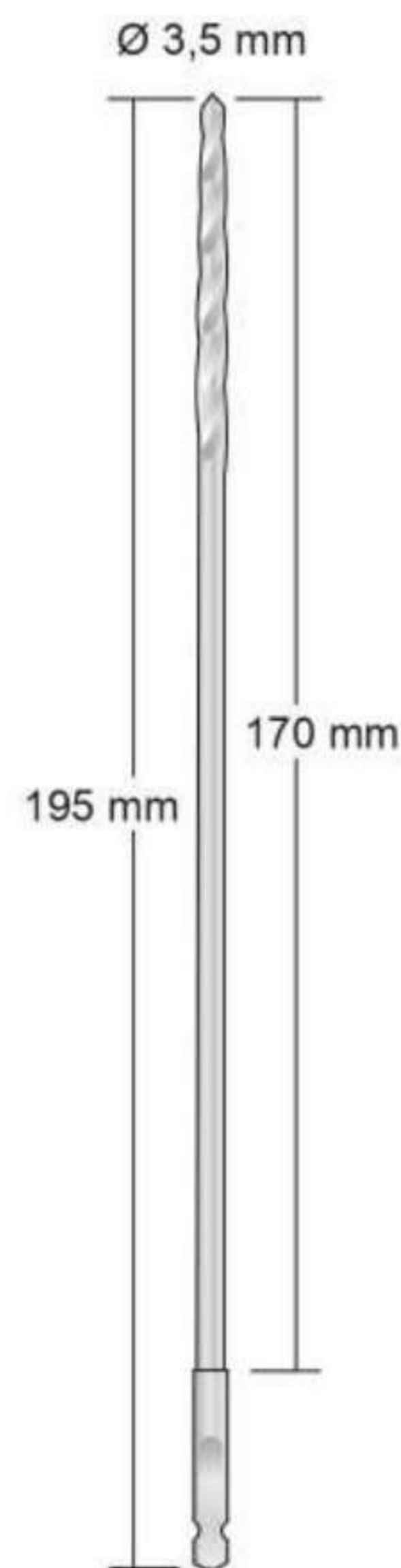

LS-28

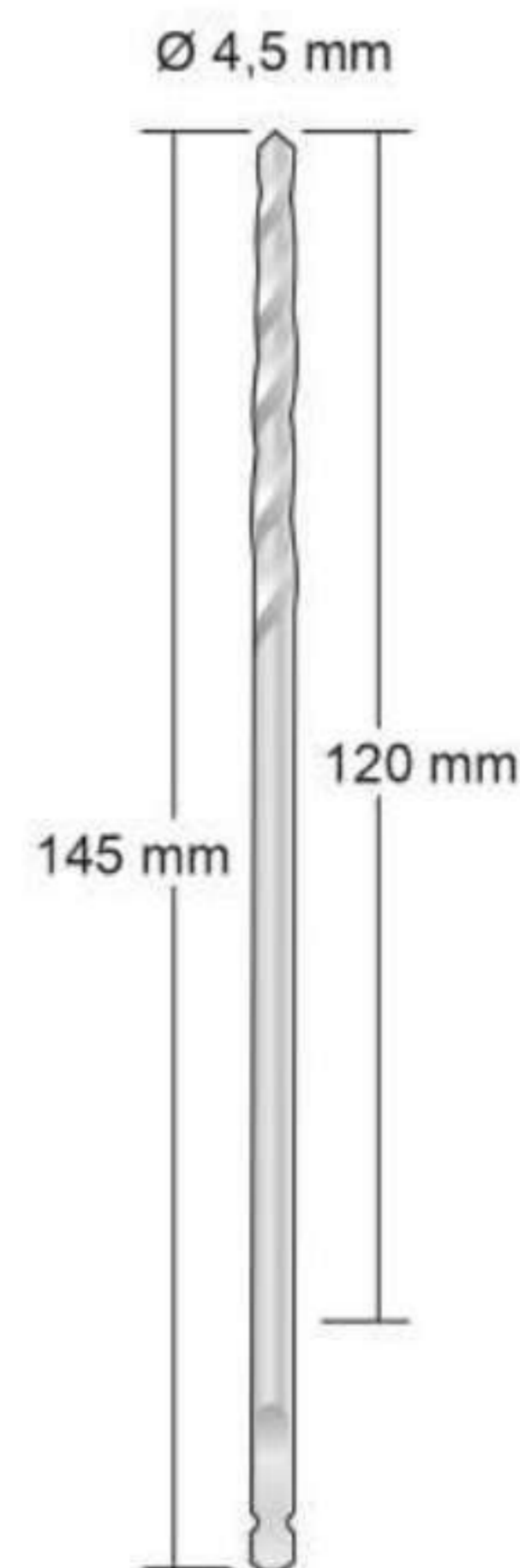

LS-29

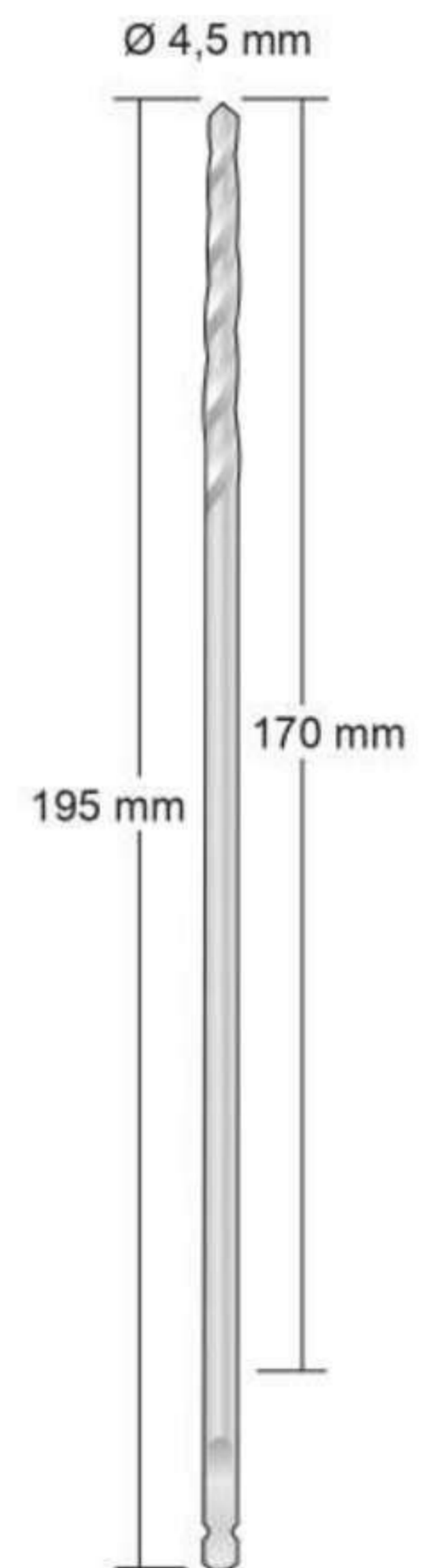

LS-30

Spiralbohrer

Twist drills

Maschiatori - Taps

Brocas espirales

Forets

Mit rundschaft
Drill bits
Con attacco rotondo

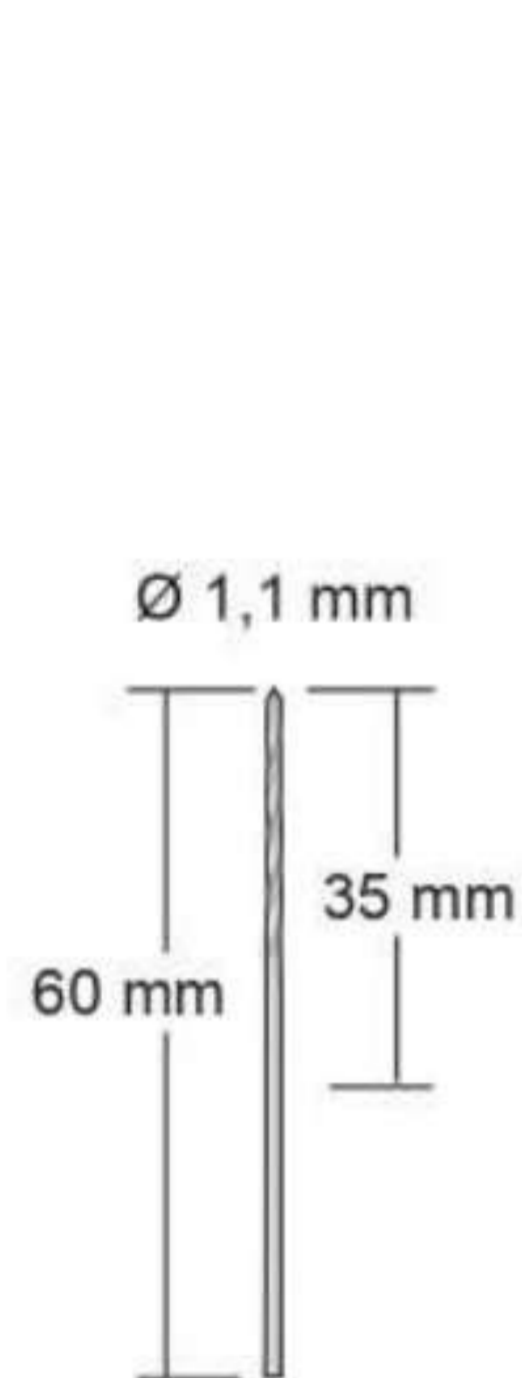

LS-40

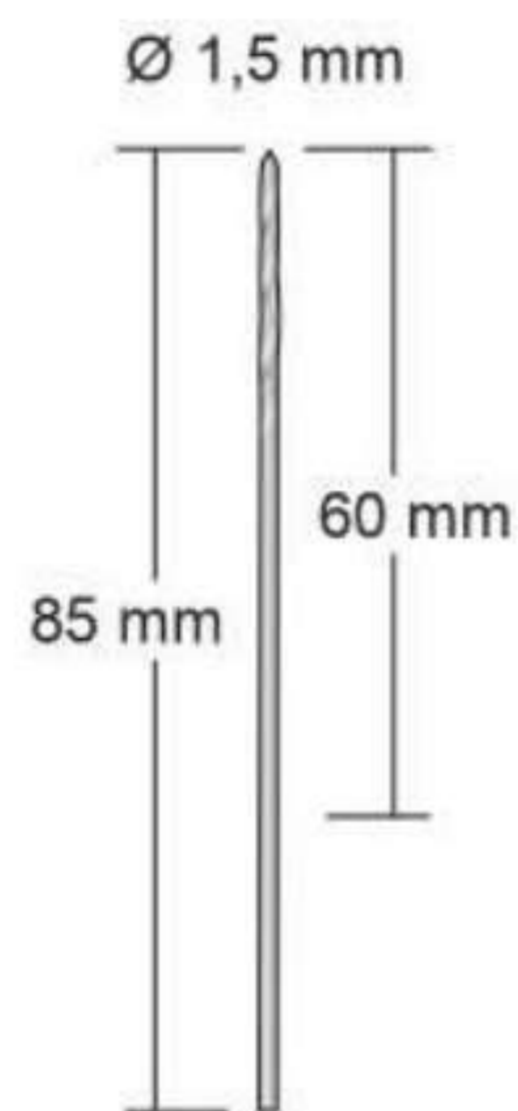

LS-41

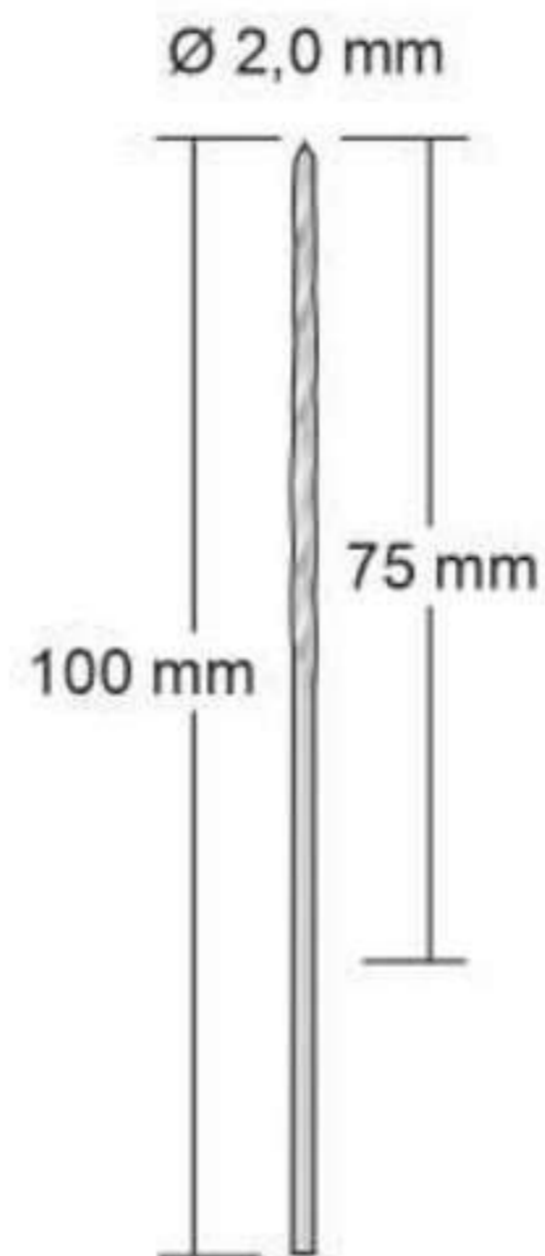

LS-42

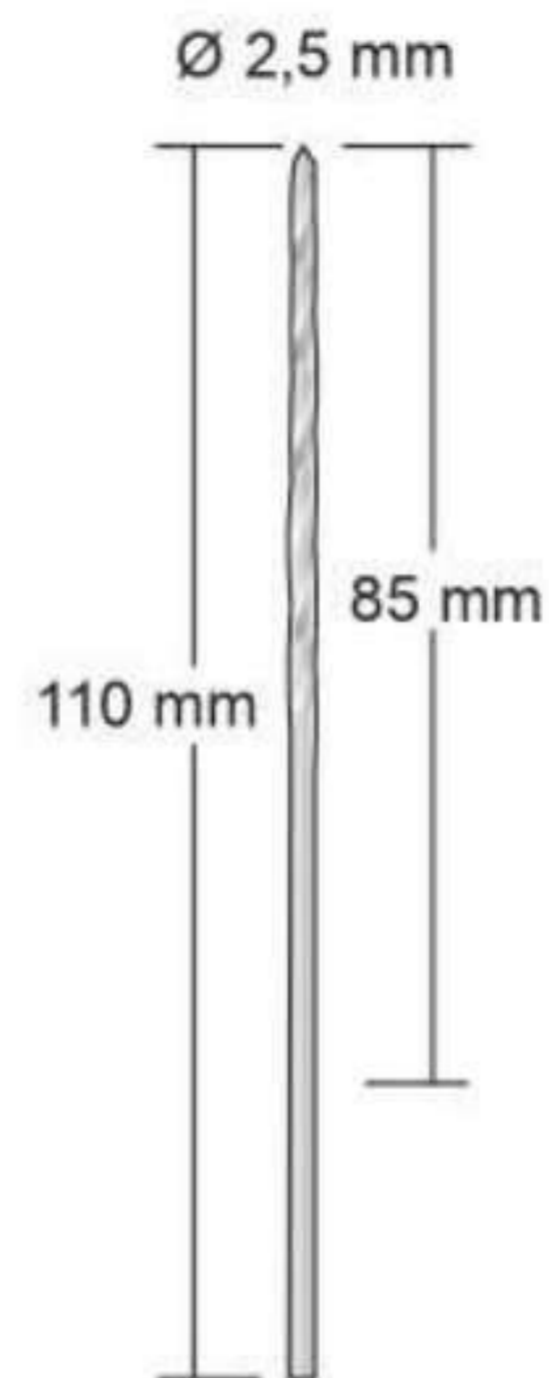

LS-43

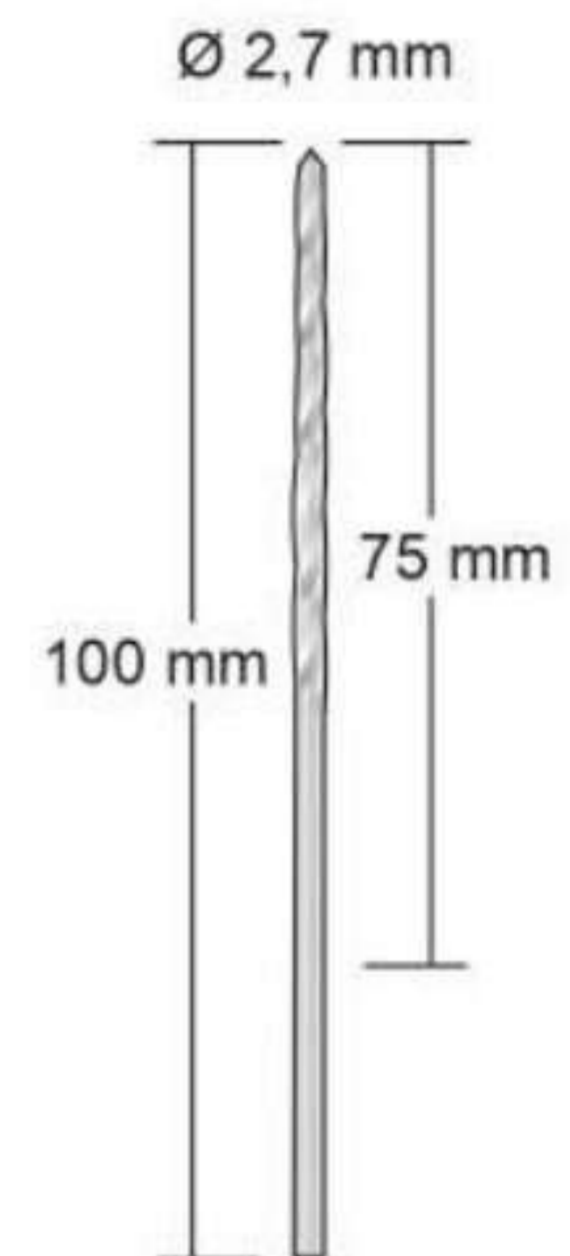

LS-44

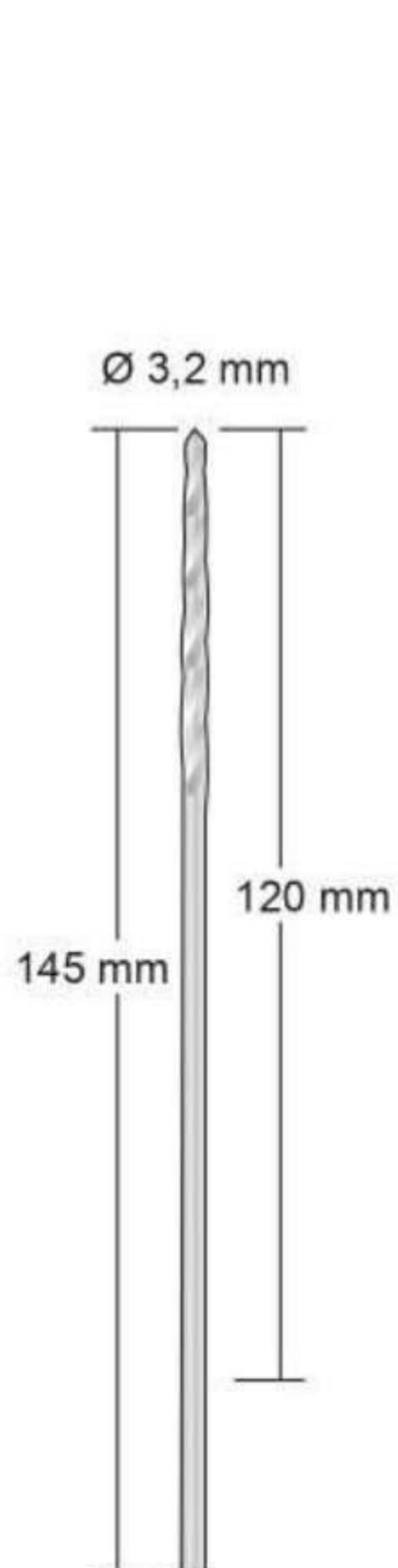

LS-45

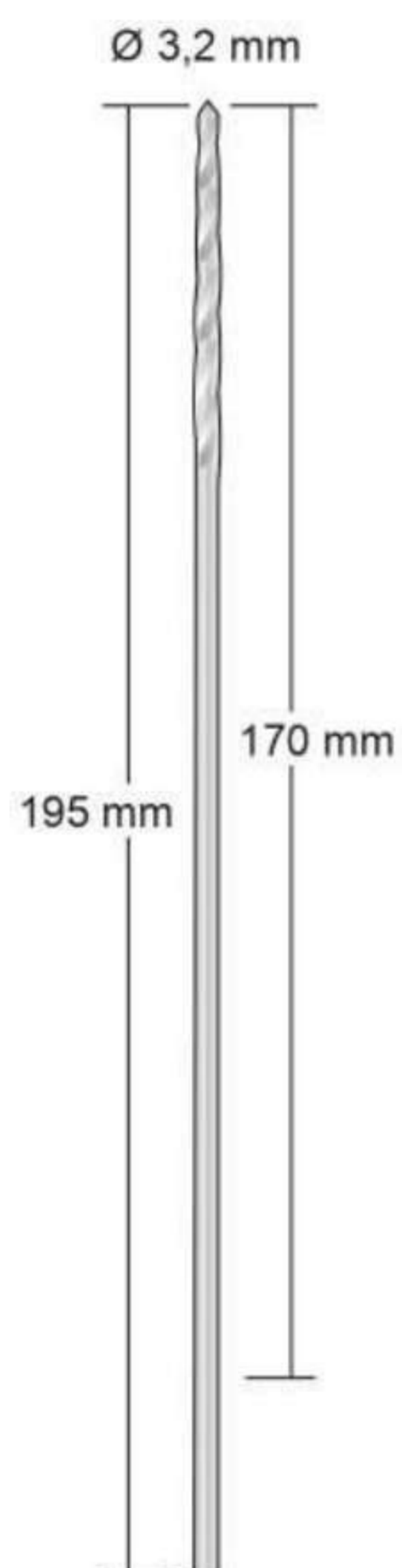

LS-46

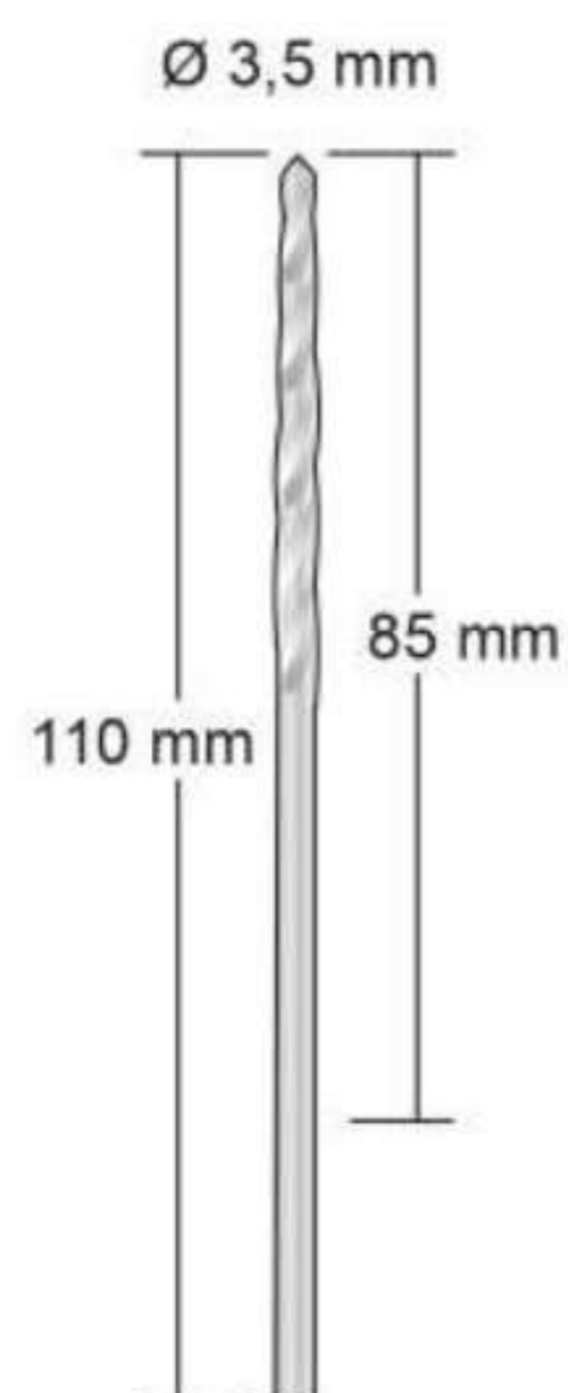

LS-47

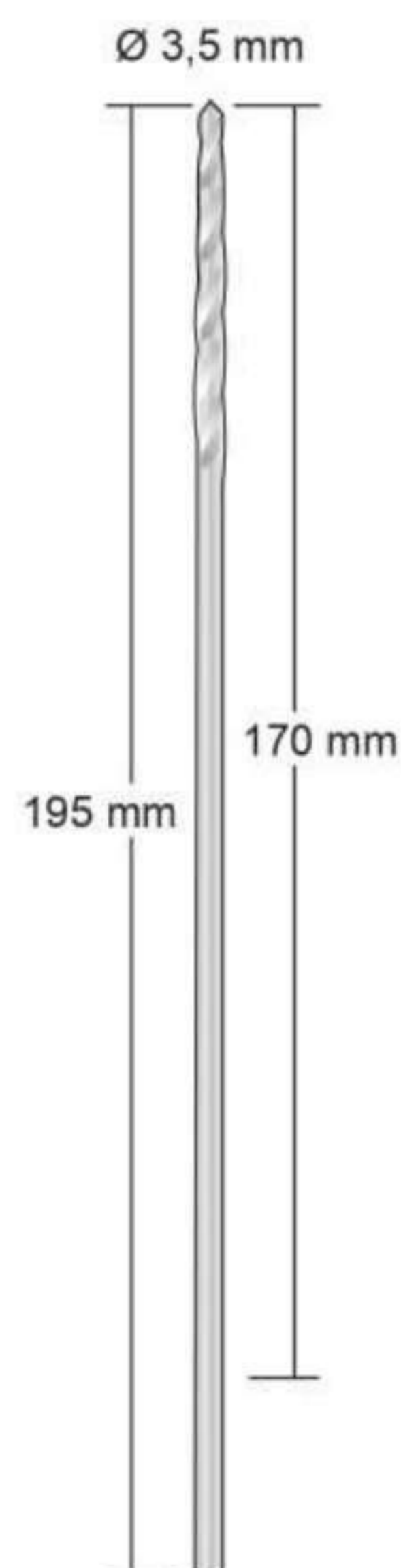

LS-48

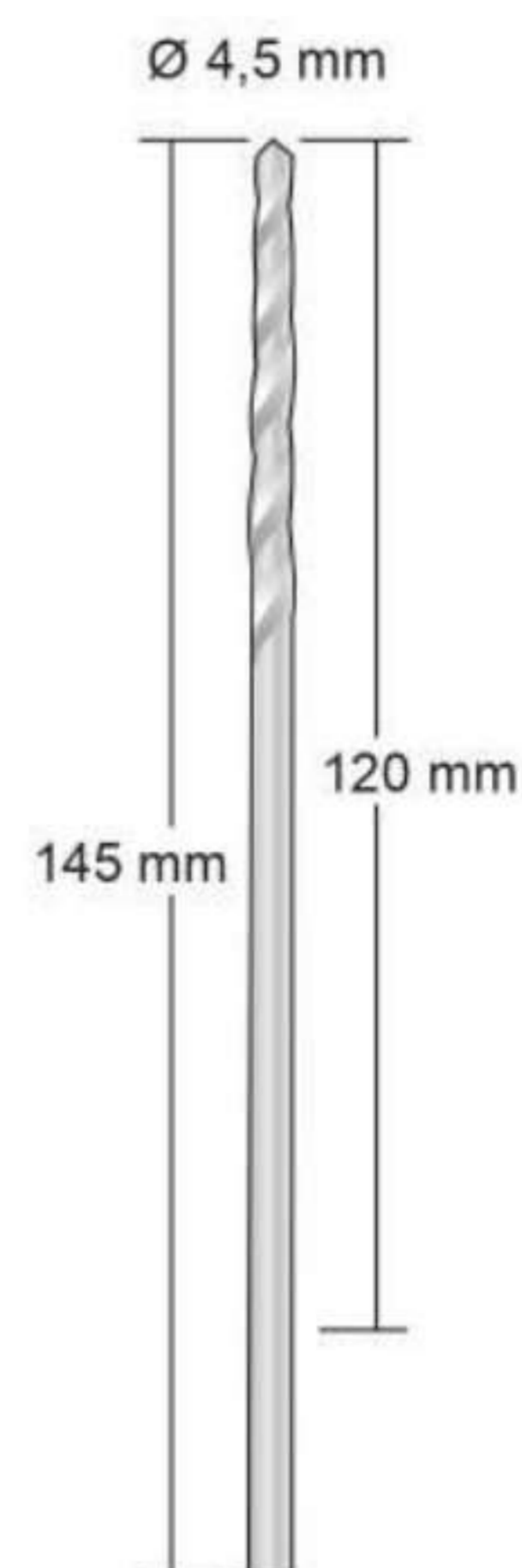

LS-49

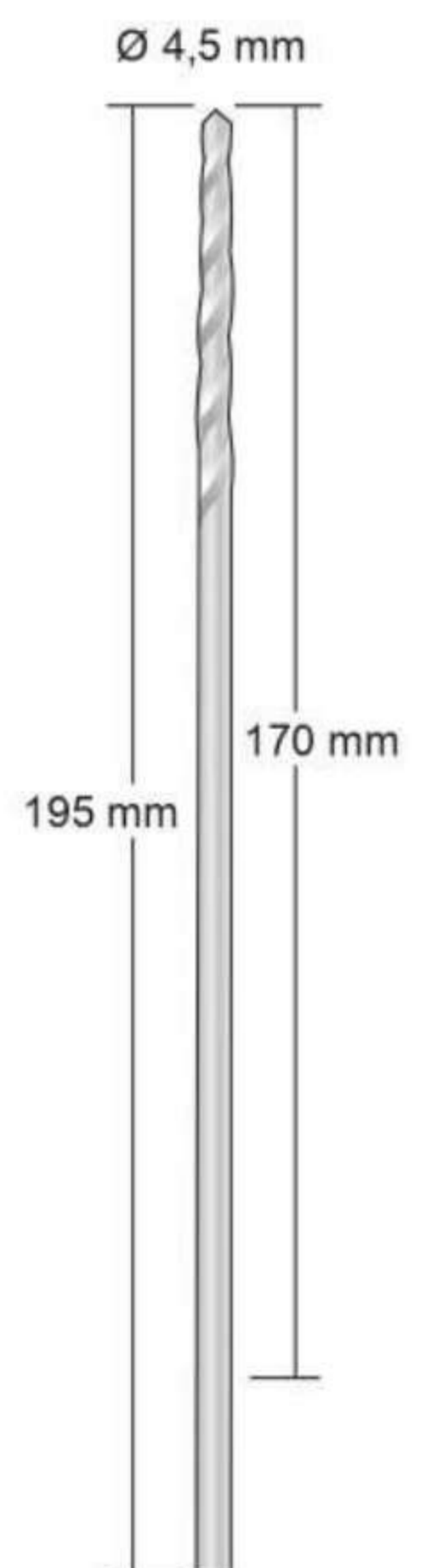

LS-50

Spiralbohrer

Twist drills

Maschiatori - Taps

Brocas espirales

Forets

Mit rundschaft
Drill bits
Con attacco rotondo

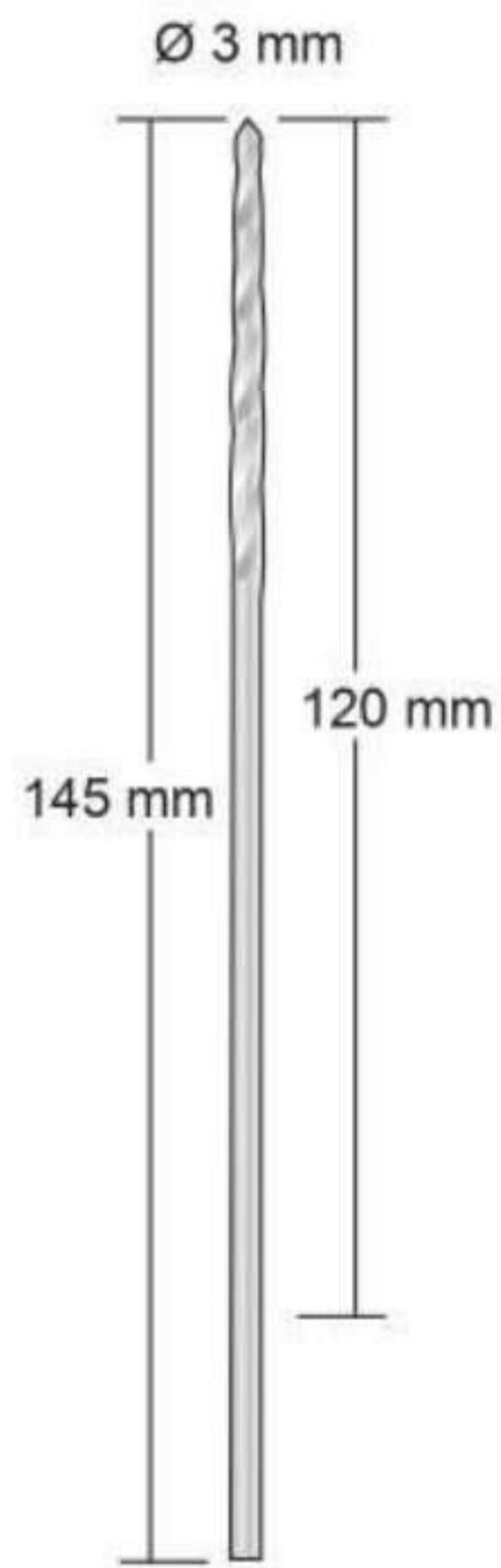

LS-51

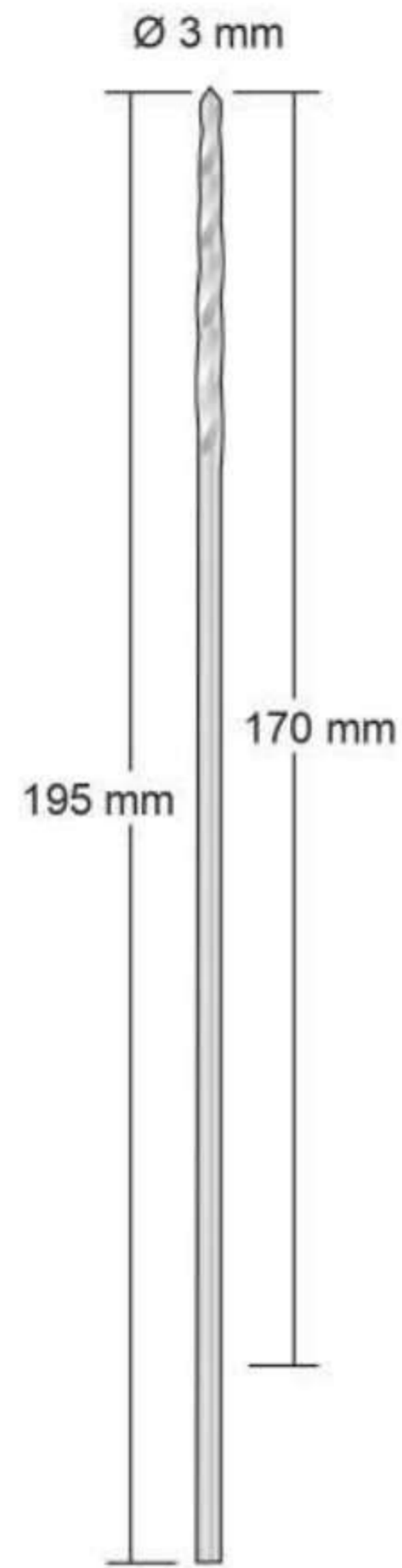

LS-52

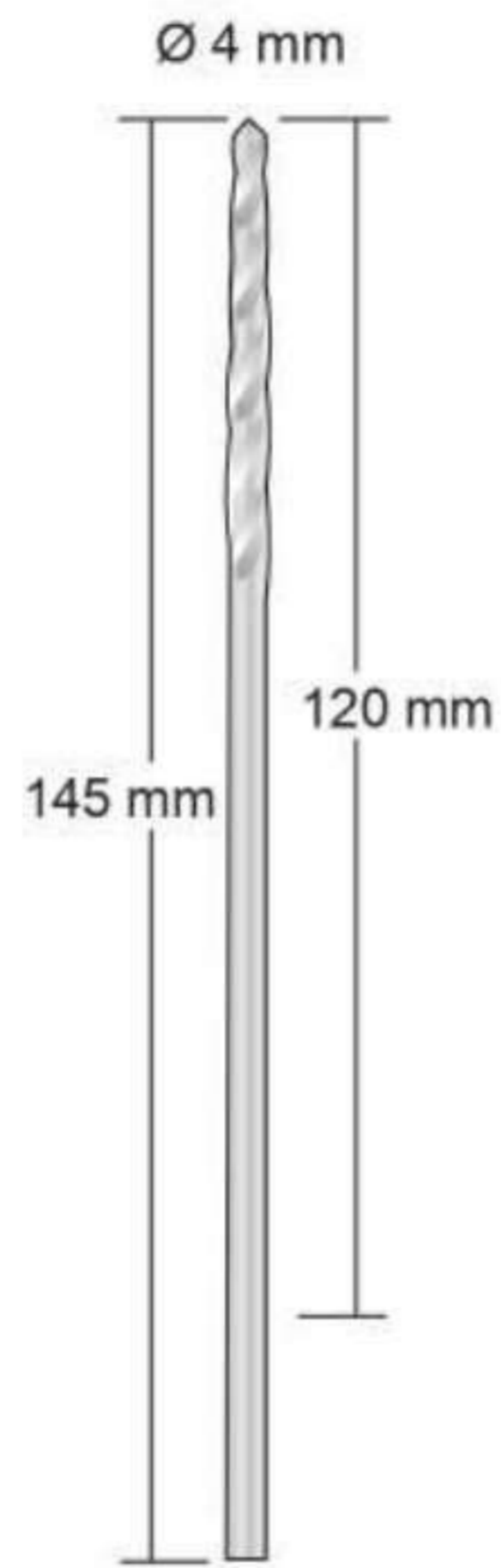

LS-53

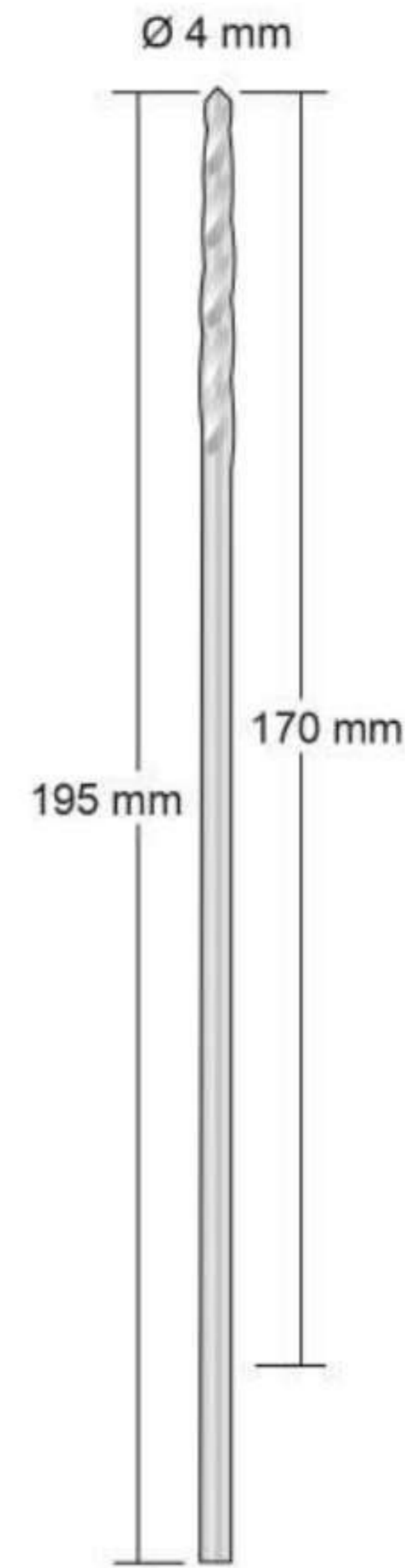

LS-54

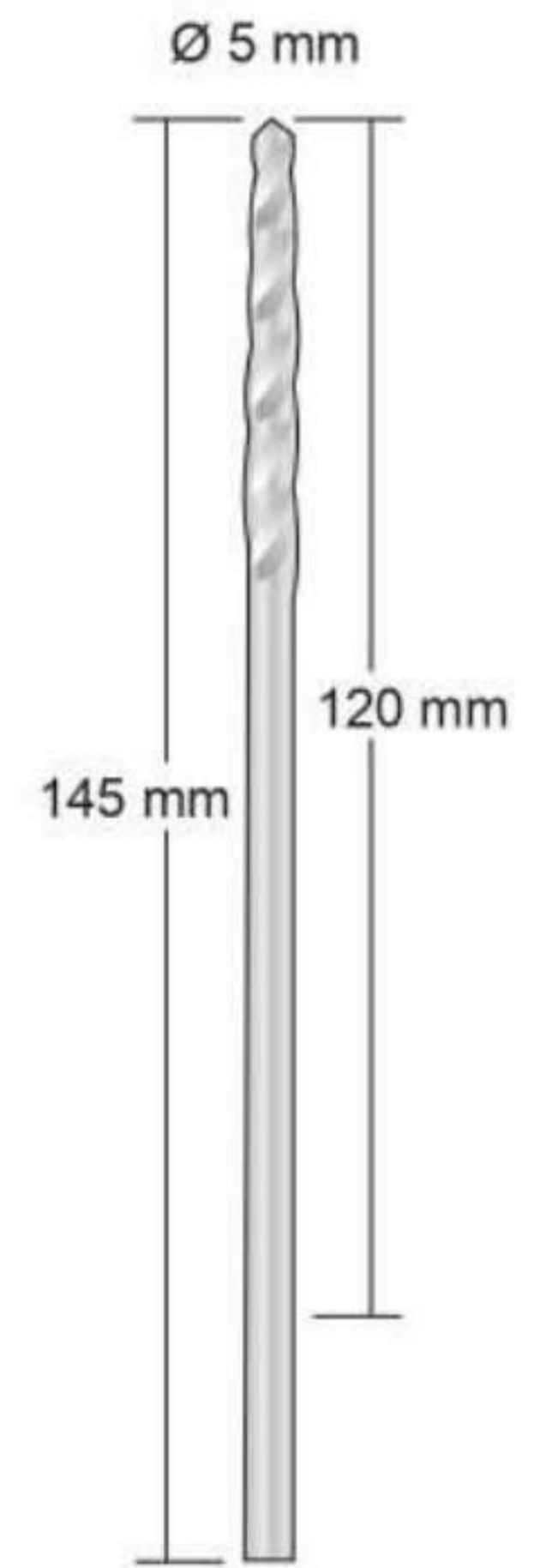

LS-55

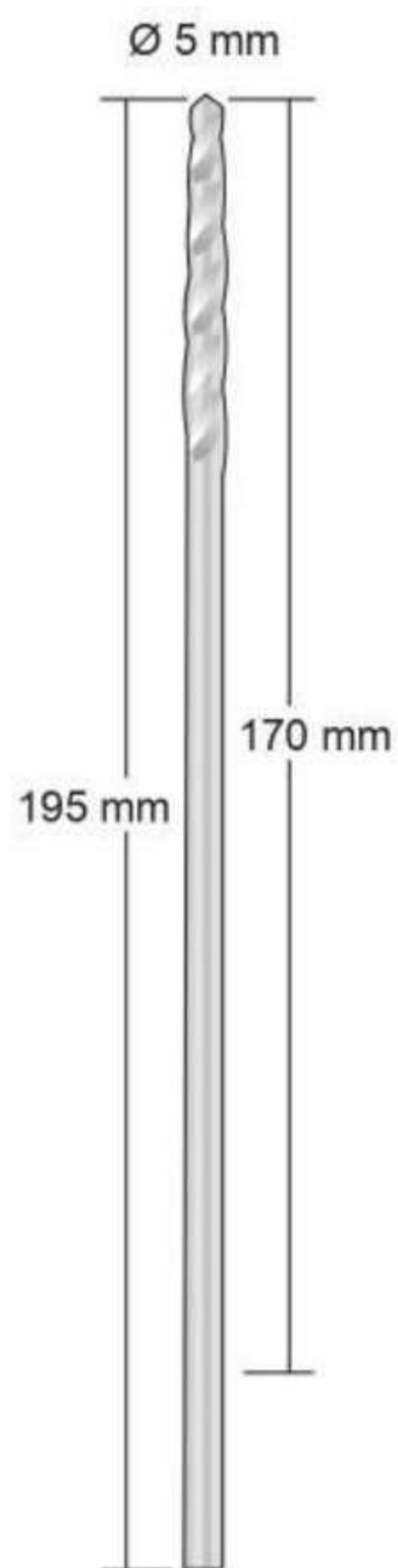

LS-56

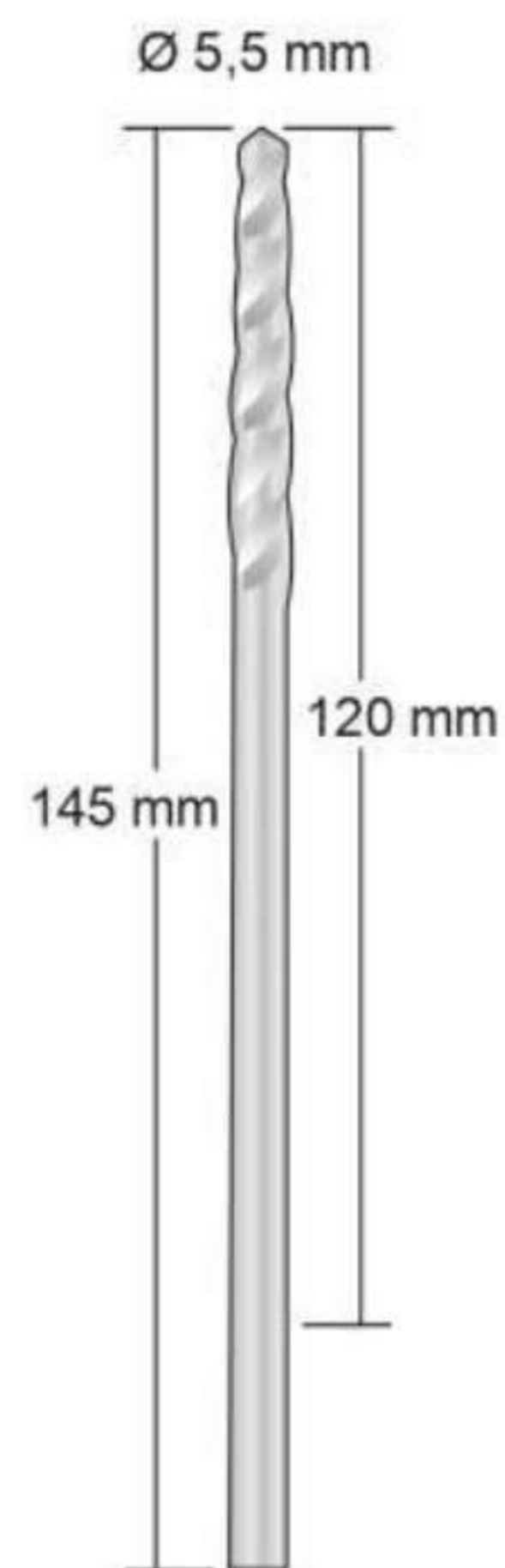

LS-57

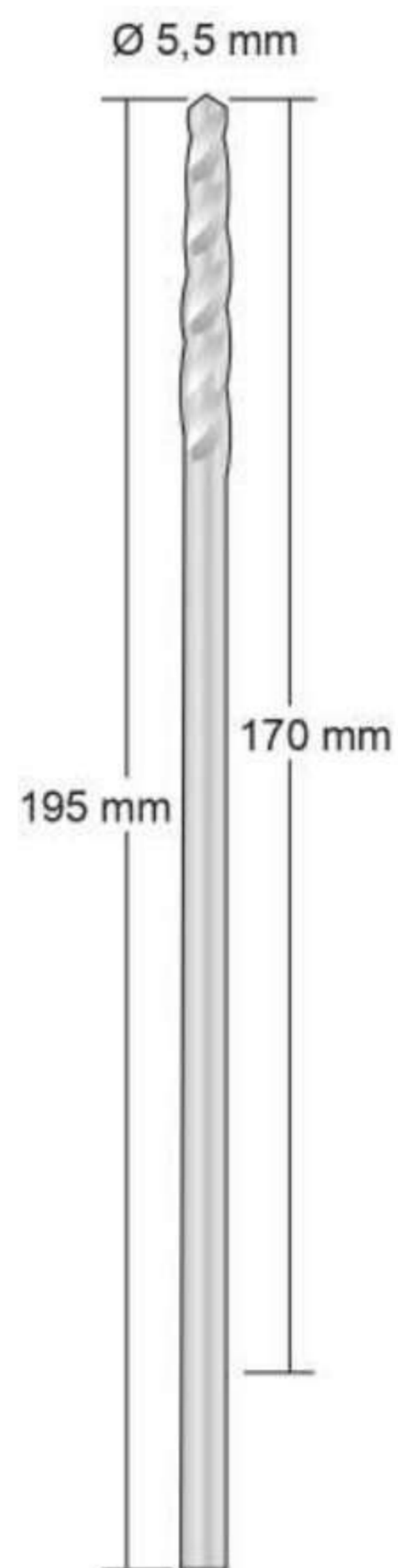

LS-58

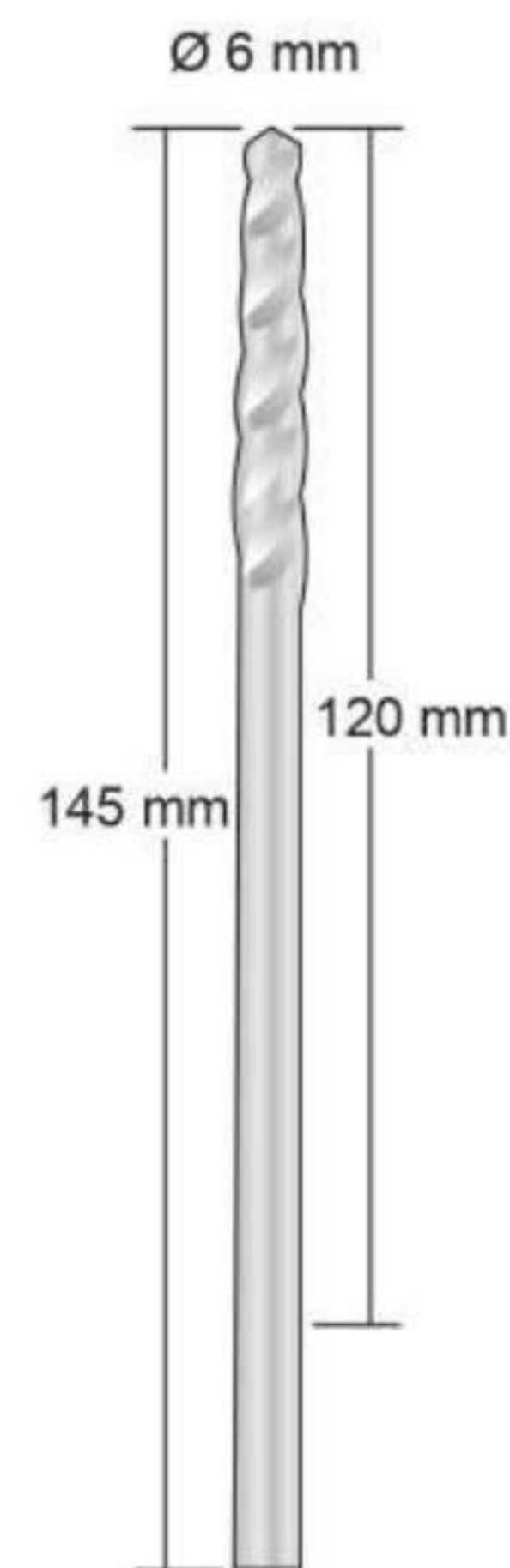

LS-59

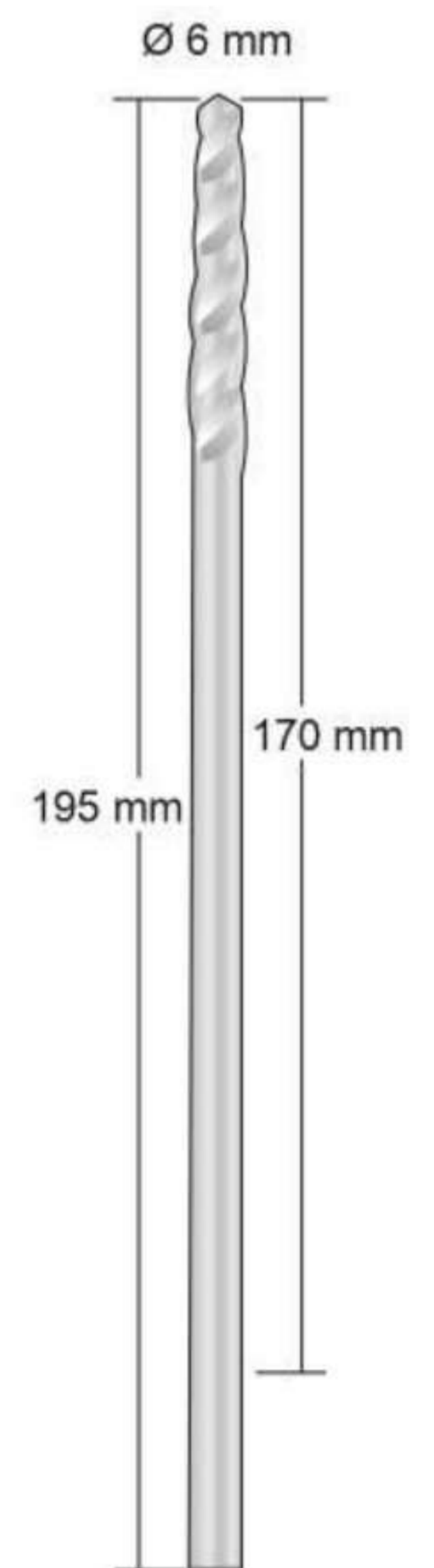

LS-60



LS-127
35 mm

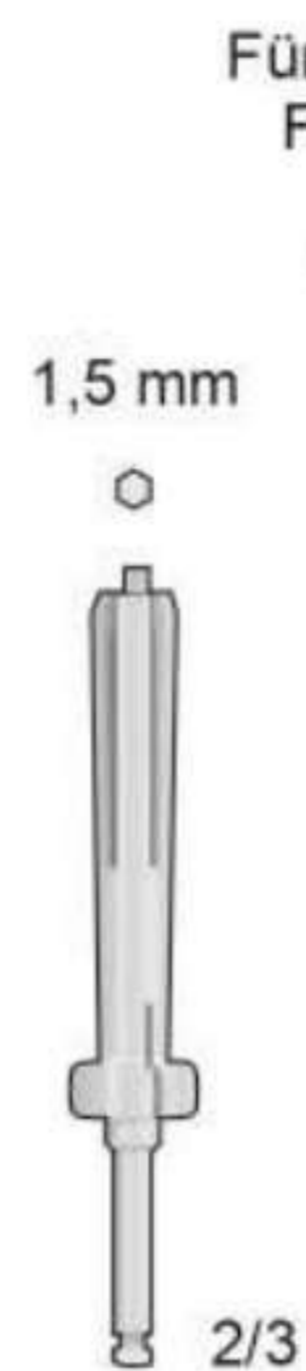

LS-135
55 mm

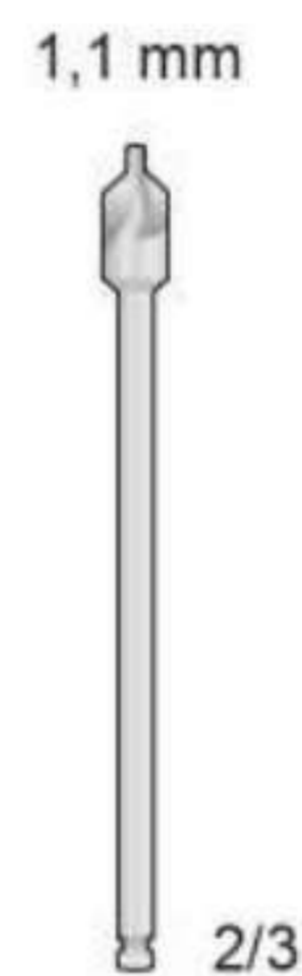

LS-136
55 mm

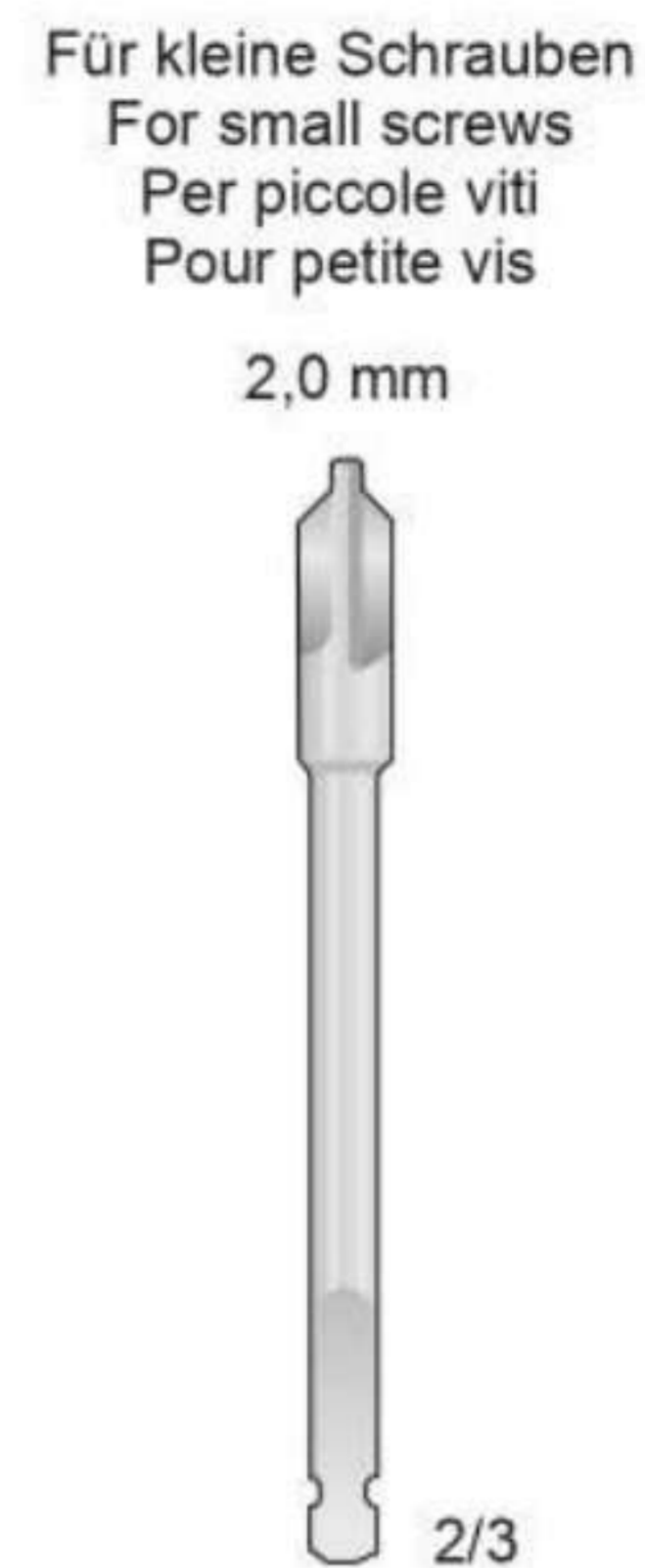

LS-137
70 mm

Für Malleolarschrauben
For malleolar screws
Per viti malleolari
Pour vis à malléole

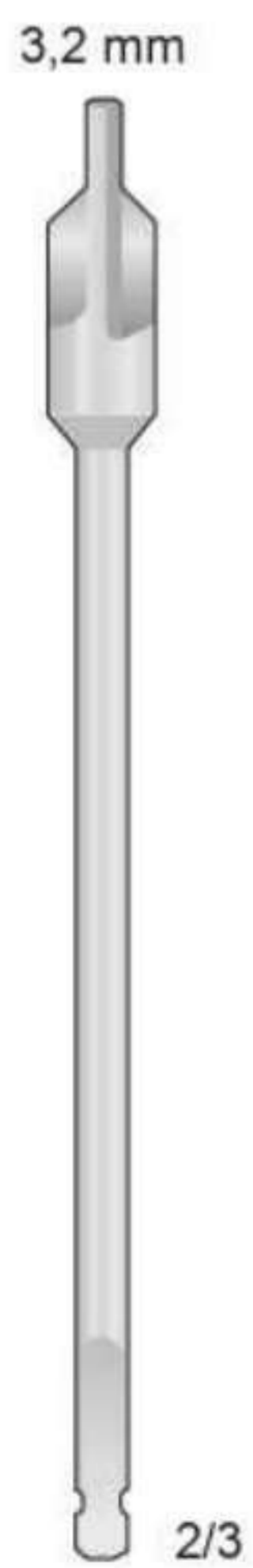

LS-138
120 mm

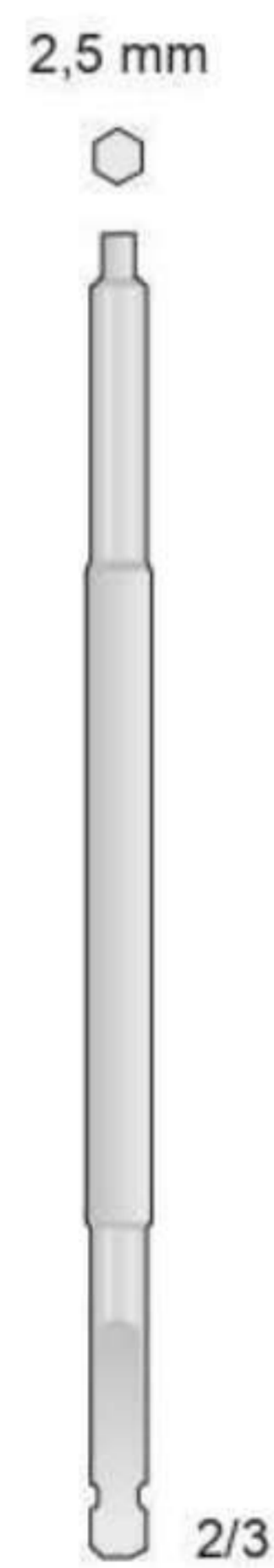

LS-125
100 mm



LS-126
90 mm

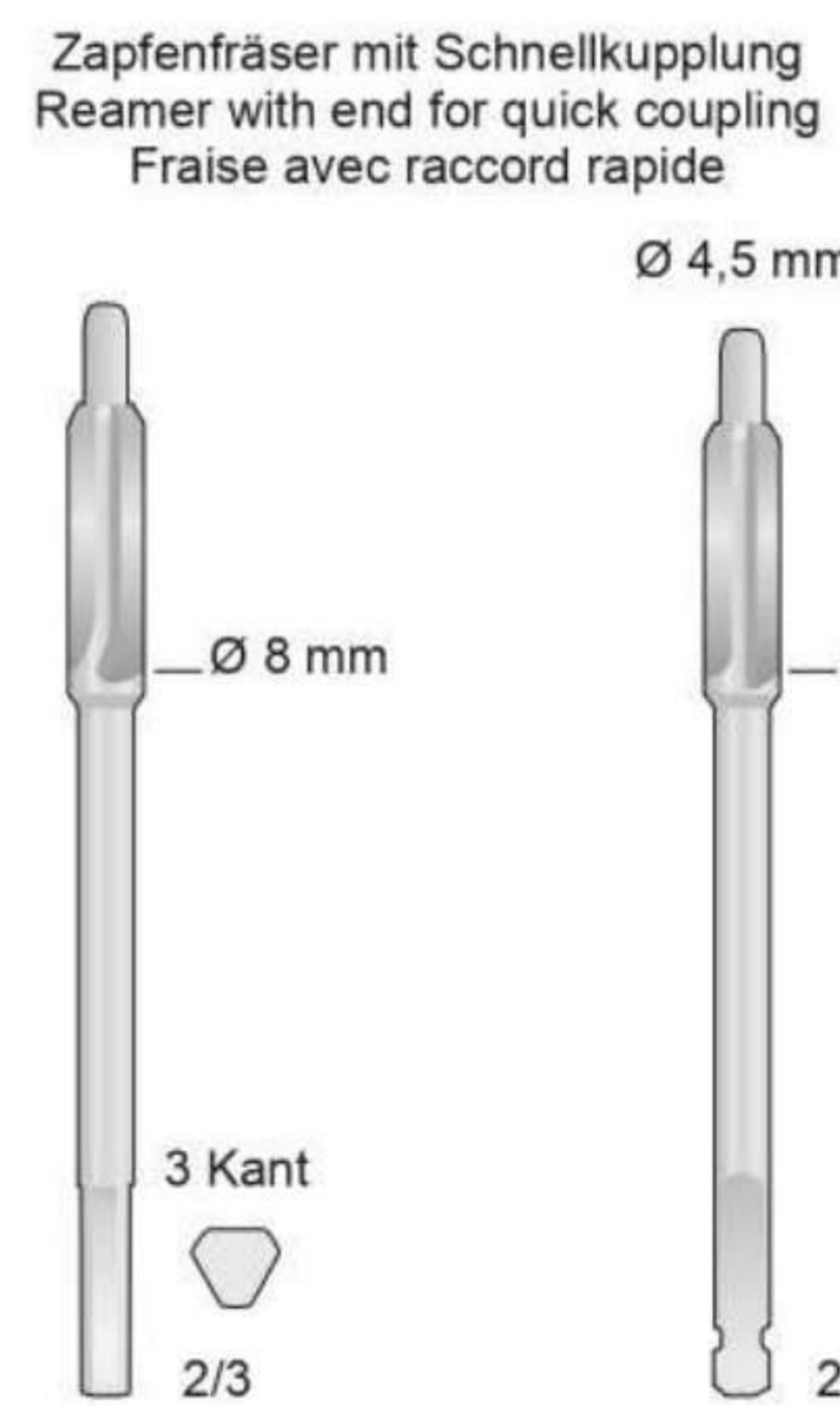

LS-139
90 mm

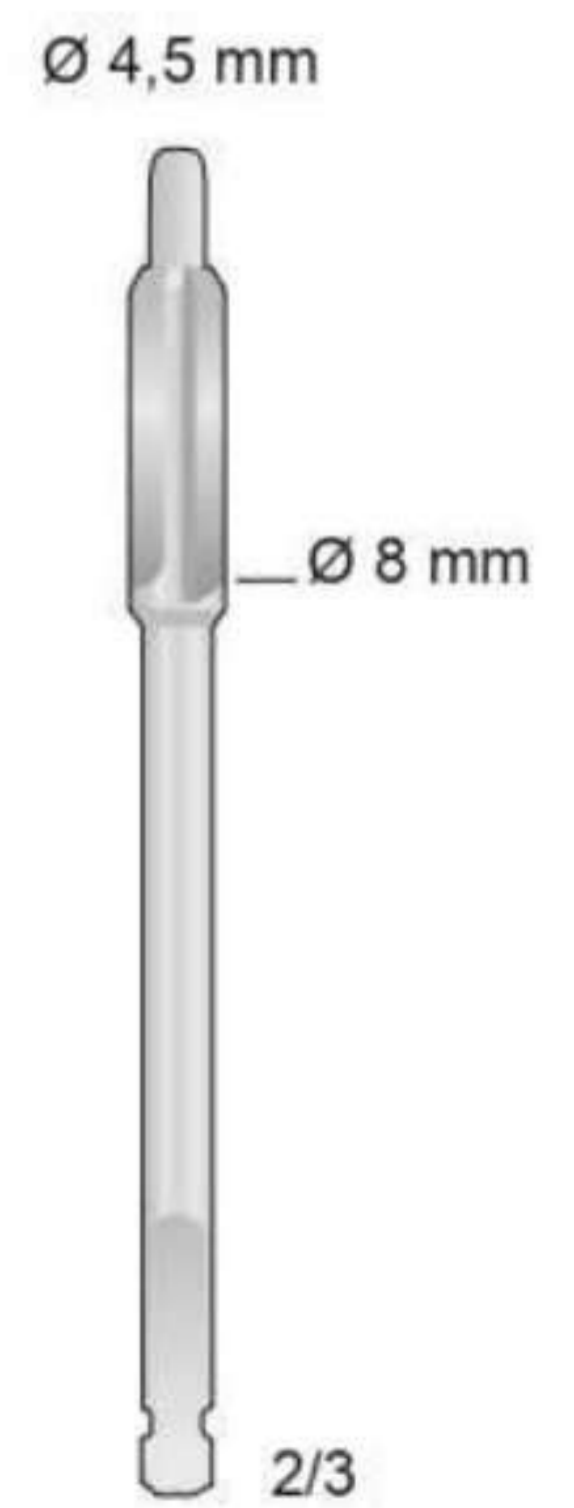

LS-140
90 mm

Handgriffe mit schnellspann futter
Handles with quick-action chuck
Manico con mandrino rapido
Poignées avec mandrins rapides

Ø 4 mm

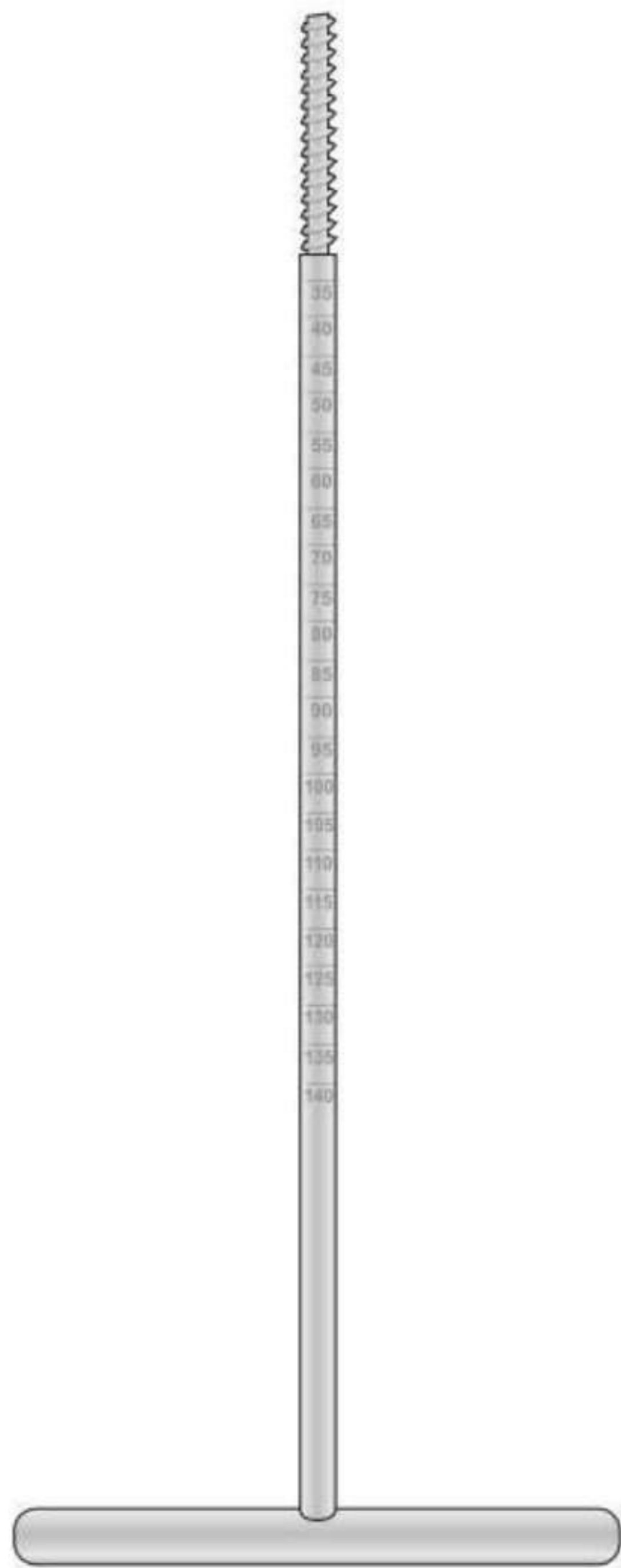

LS-120
260 mm

AO-Schaft



MANICO FERROZELL
LS-242
125 mm

Dental-Schaft



LS-244
110 mm

4kant-Schaft

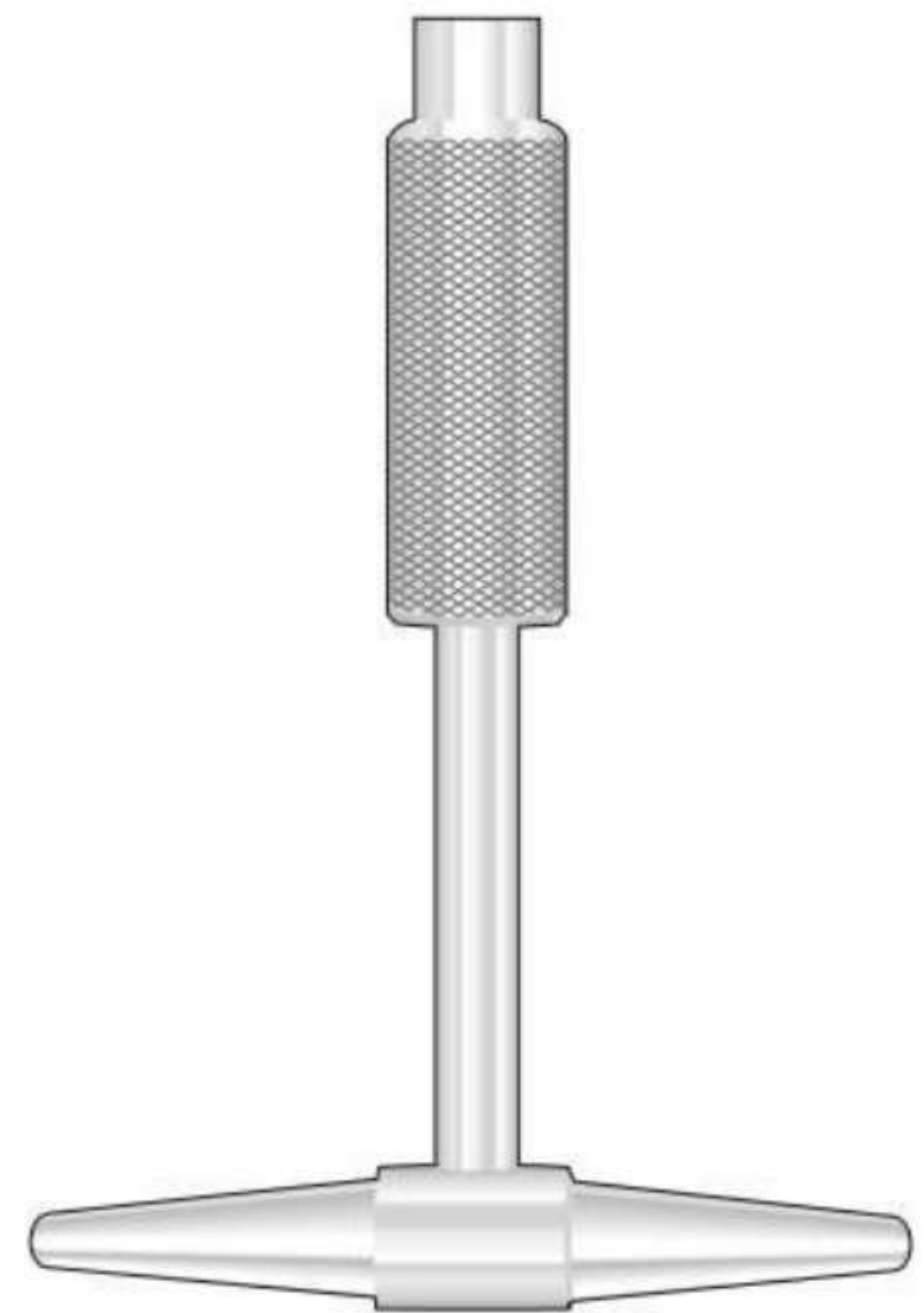

LS-240
80 mm

LS-233
Komplett mit - Complete with
Completo con - Completos con
Completos avec:
1 **LS-236**
1 **LS-229**
1 **LS-241**

Attacco AO

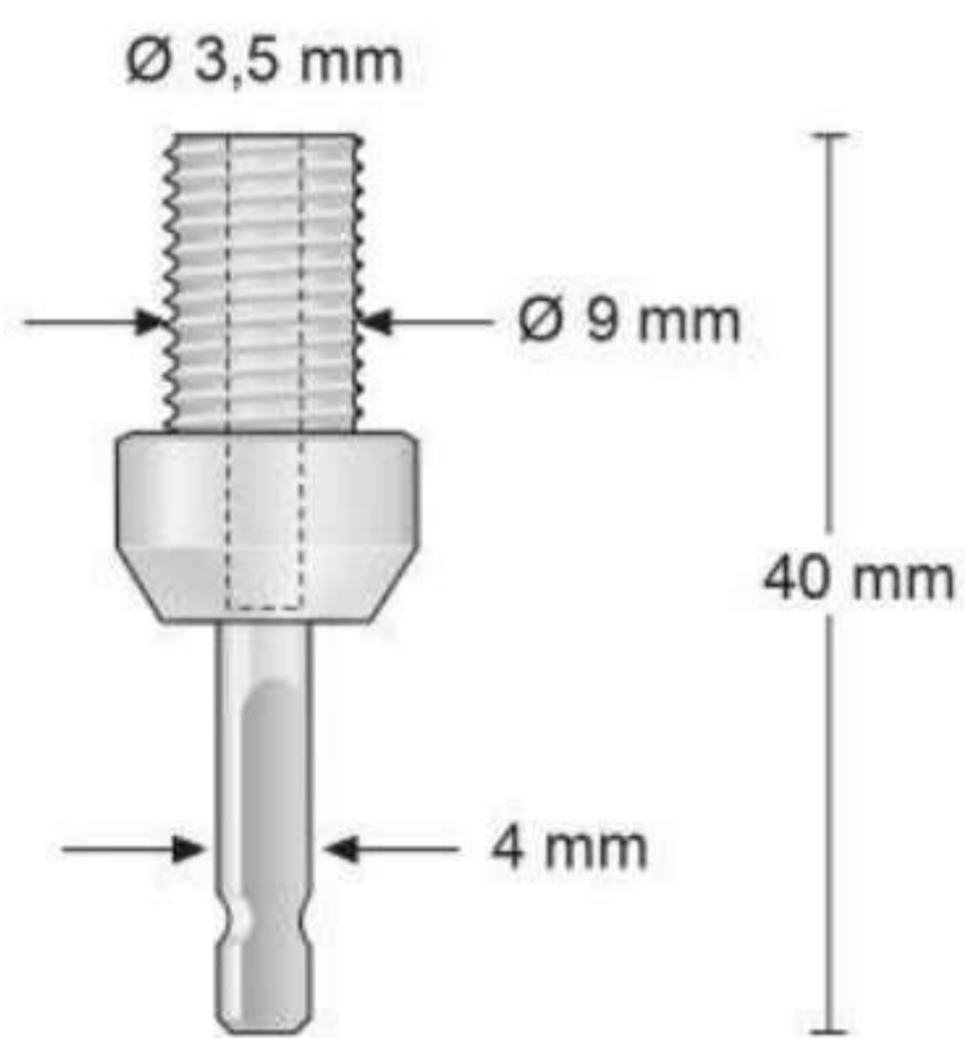

LS-227
40 mm

Inox
ORIGINAL JACOBS

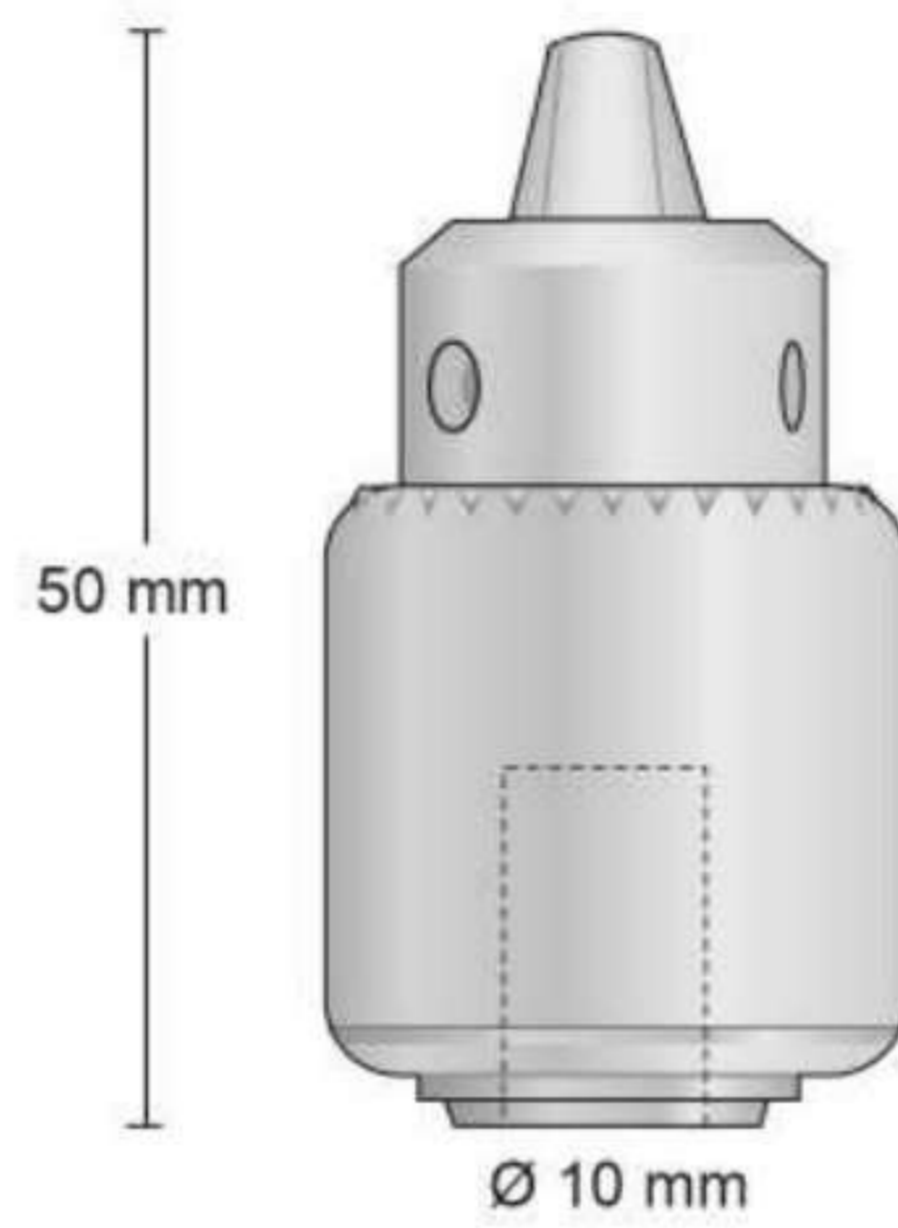

LS-236
50 mm

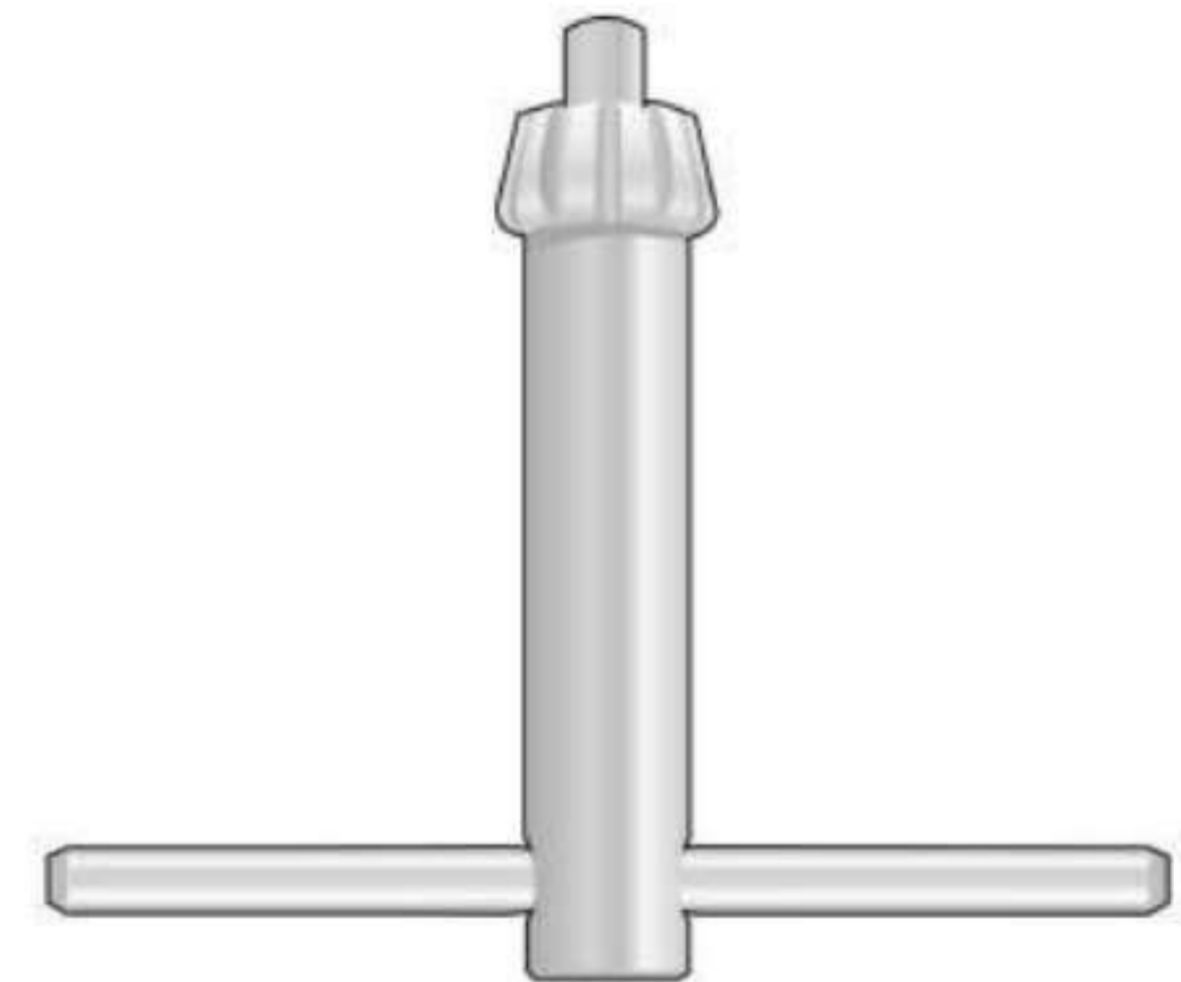

LS-241
52 mm

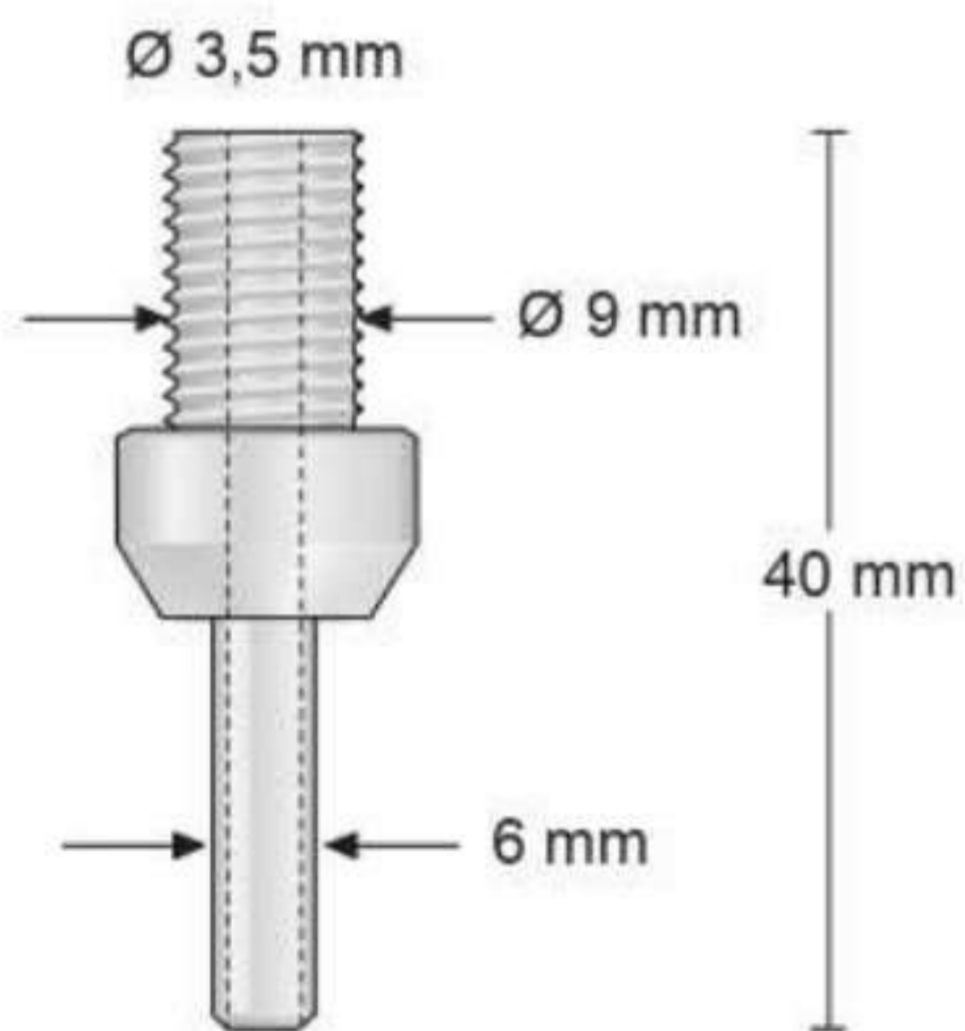

LS-228
40 mm

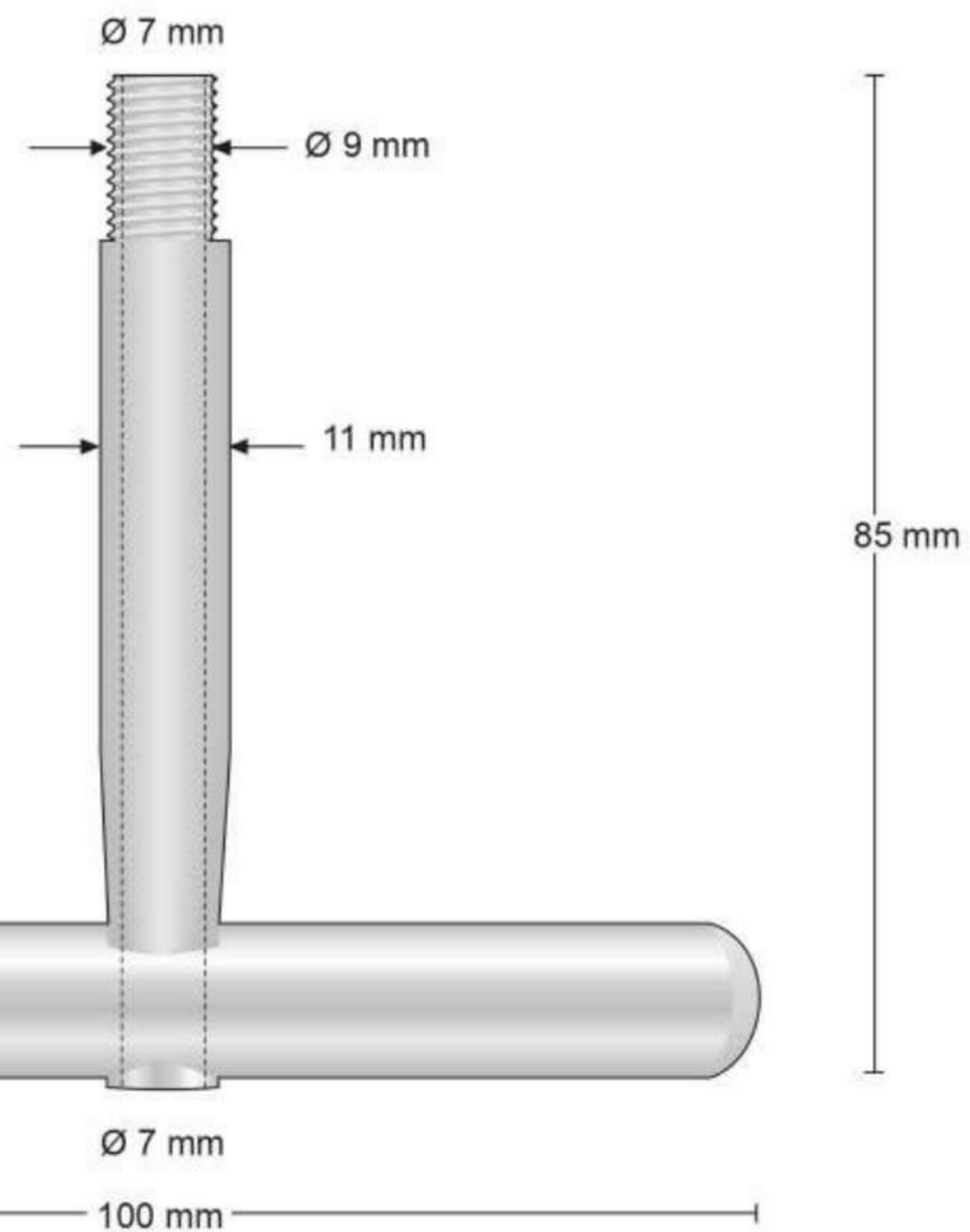

LS-229
85 mm

LS-239
 Komplett mit - Complete with
 Completo con - Completos con
 Completes avec:
 1 **LS-236**
 1 **LS-237**
 1 **LS-238**
 1 **LS-241**

Inox
 ORIGINAL JACOBS

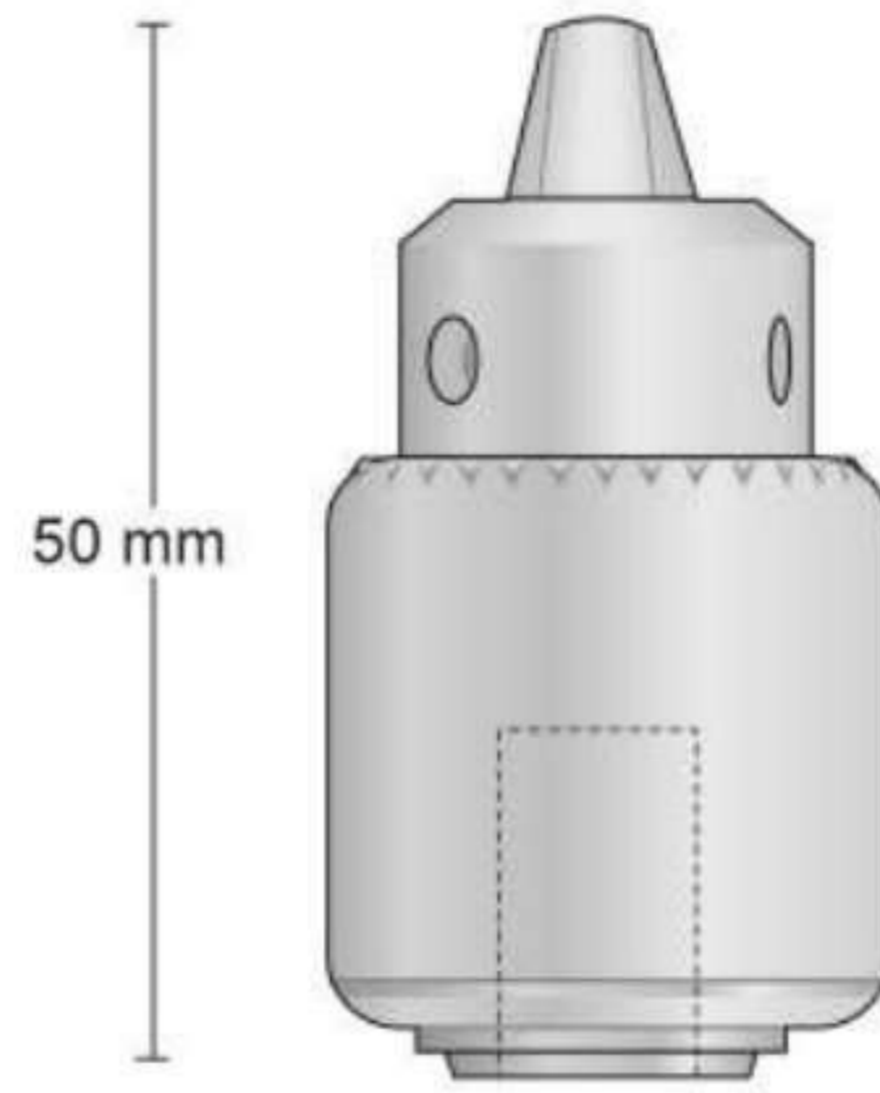

Ø 10 mm
LS-236
 50 mm

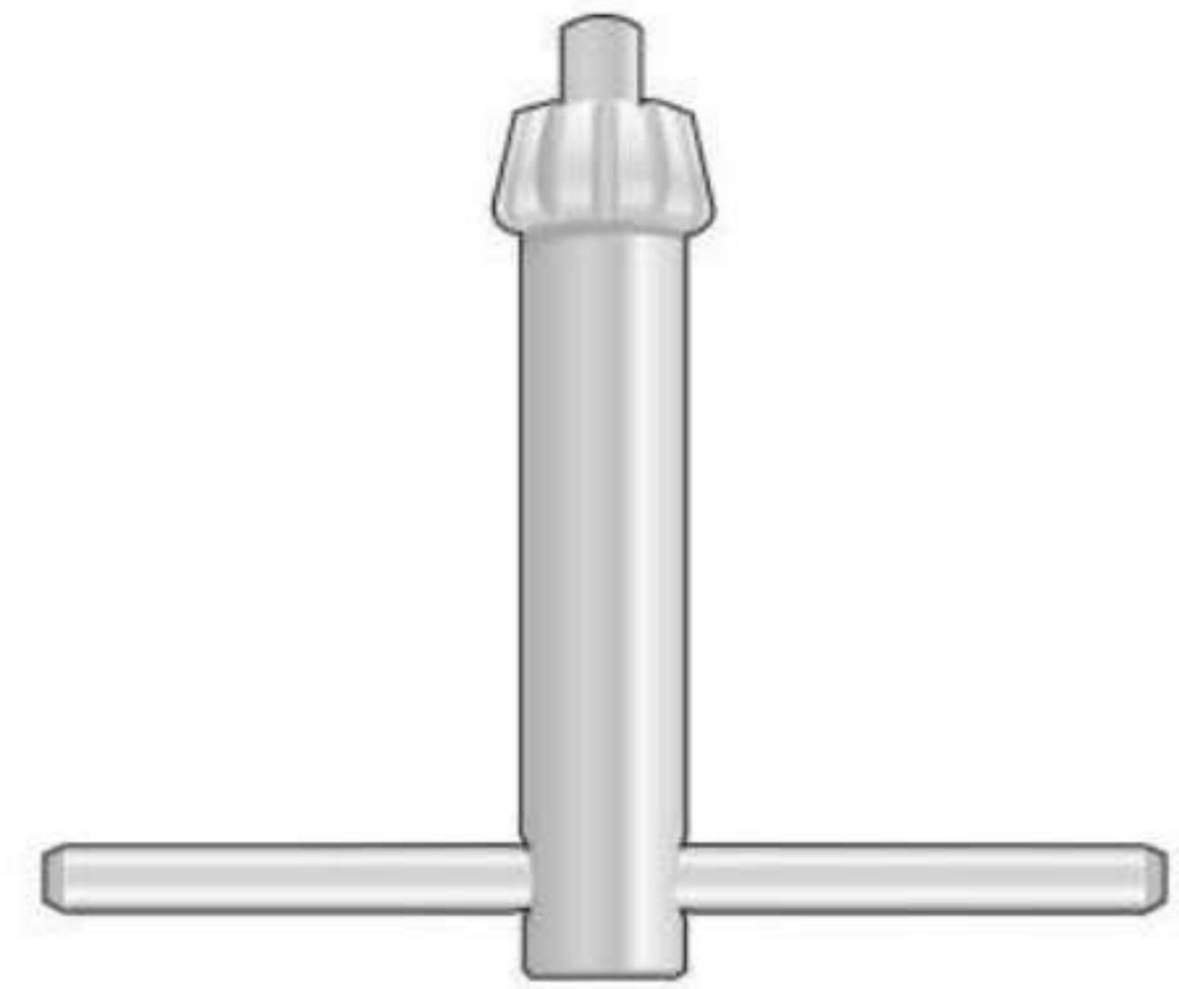

LS-241
 52 mm

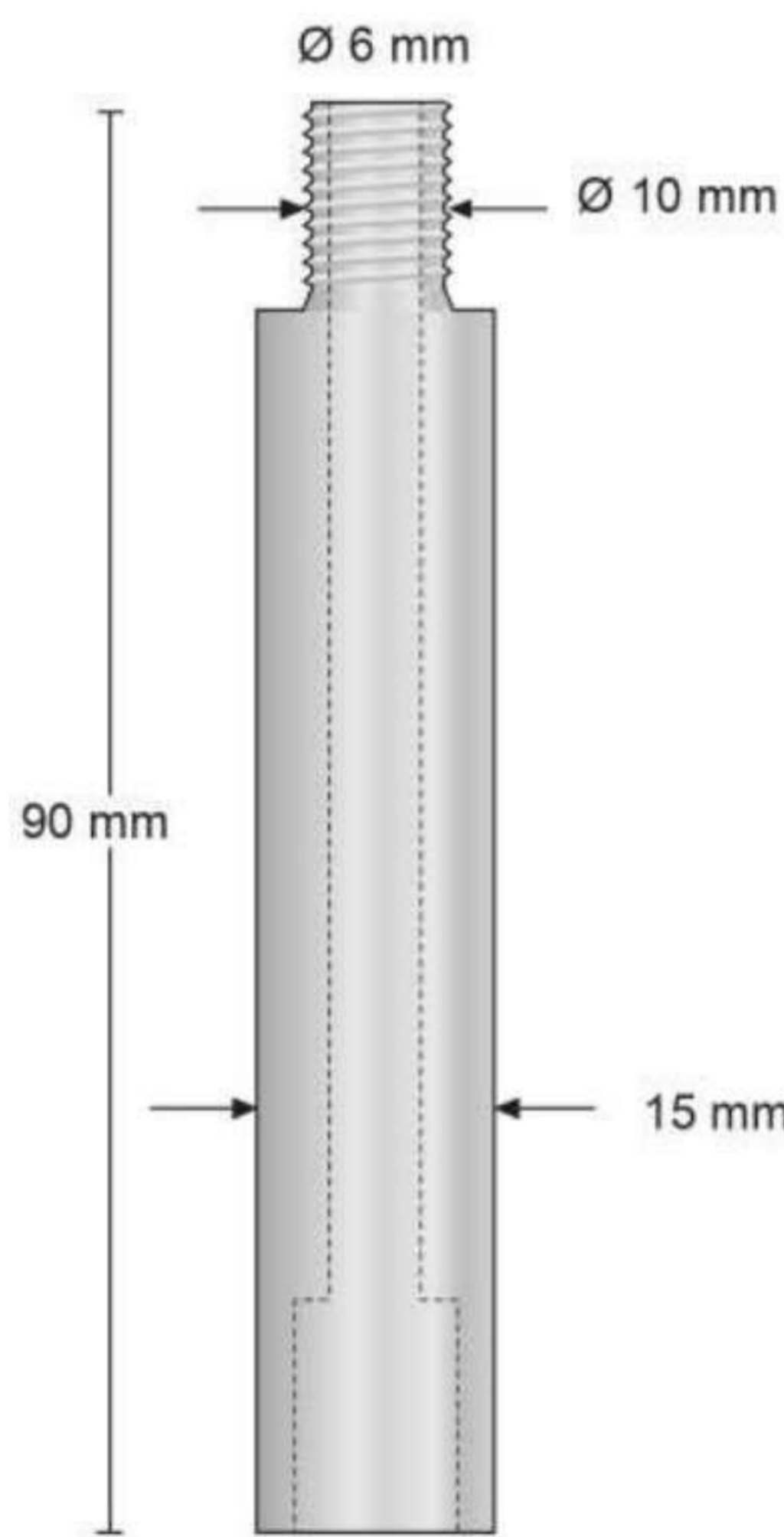

Ø 10 mm
LS-237
 90 mm

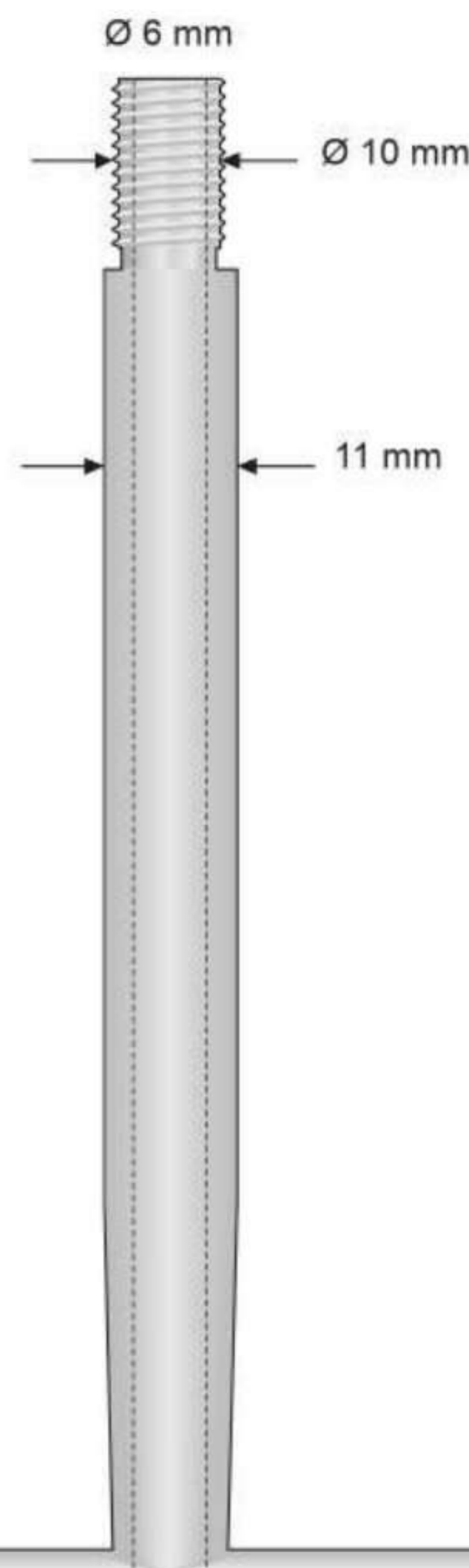

Ø 6 mm
 100 mm
LS-238
 130 mm

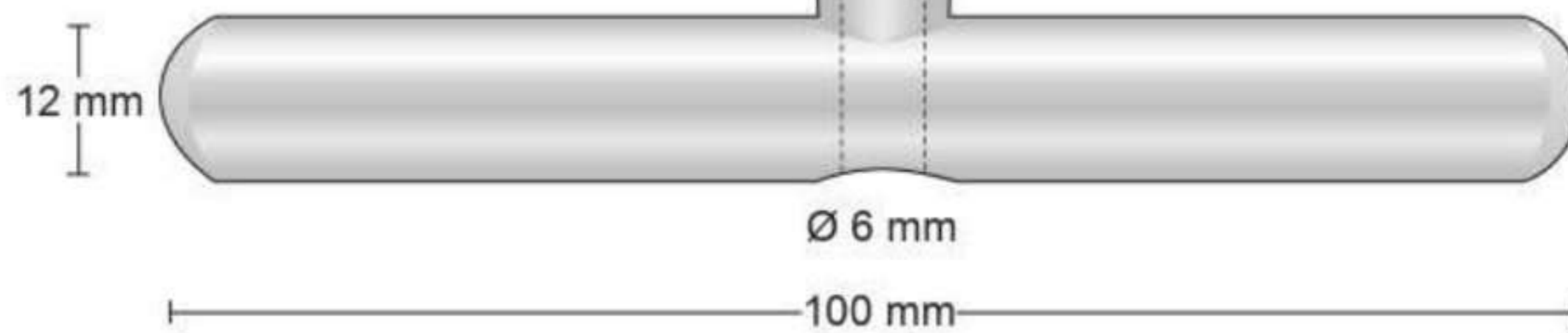

Inox
Ap. 7 mm

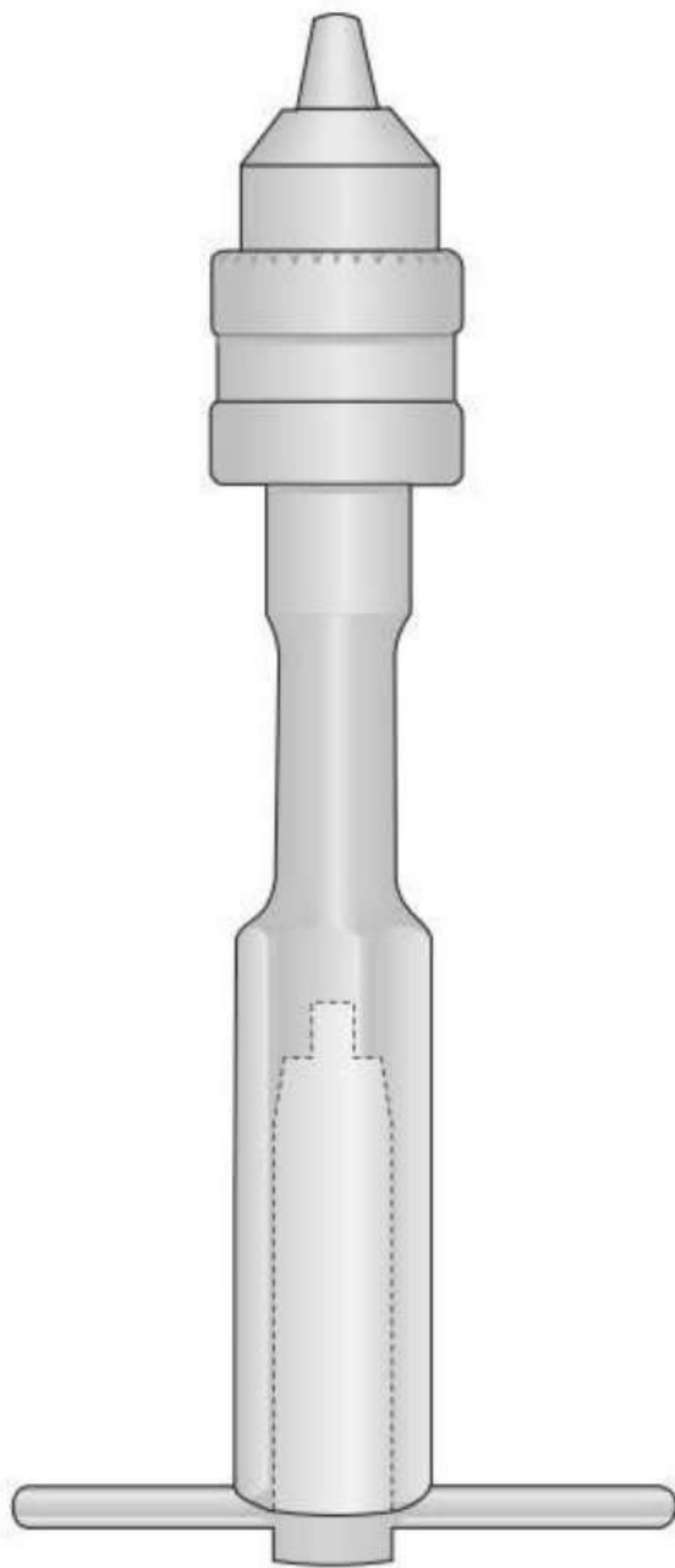

LS-232
130 mm

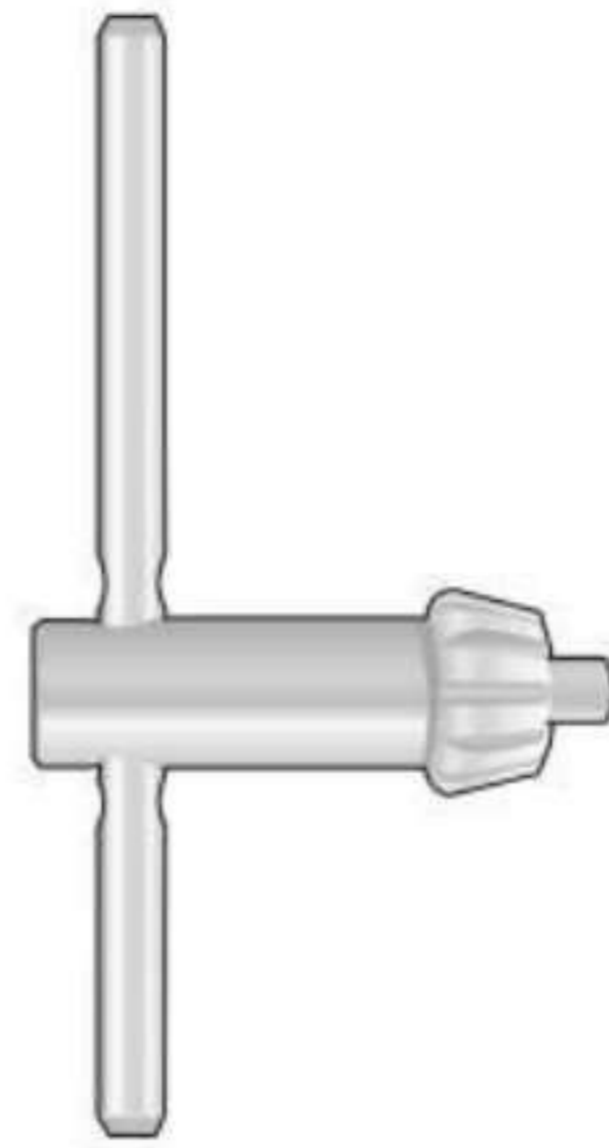

LS-231
32 mm

Von Handt zu spannen
Tightened by hand
Con chiusura a mano

Inox
Spannbereich
0 - 3 mm

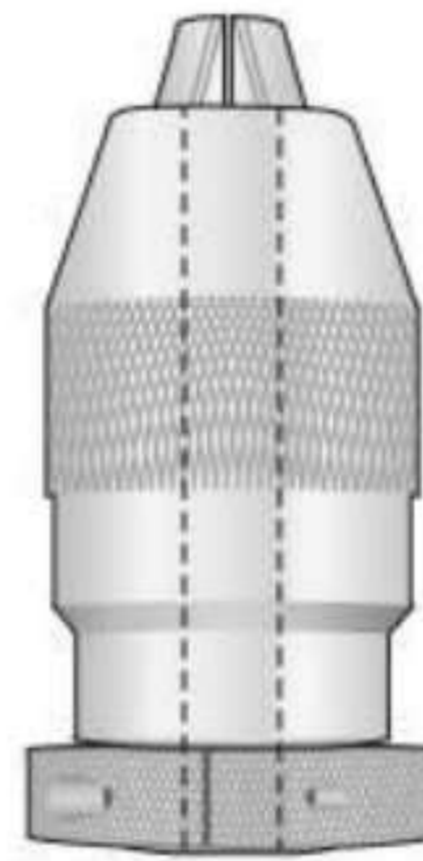

LS-222

Inox
Spannbereich
0,8 - 6 mm

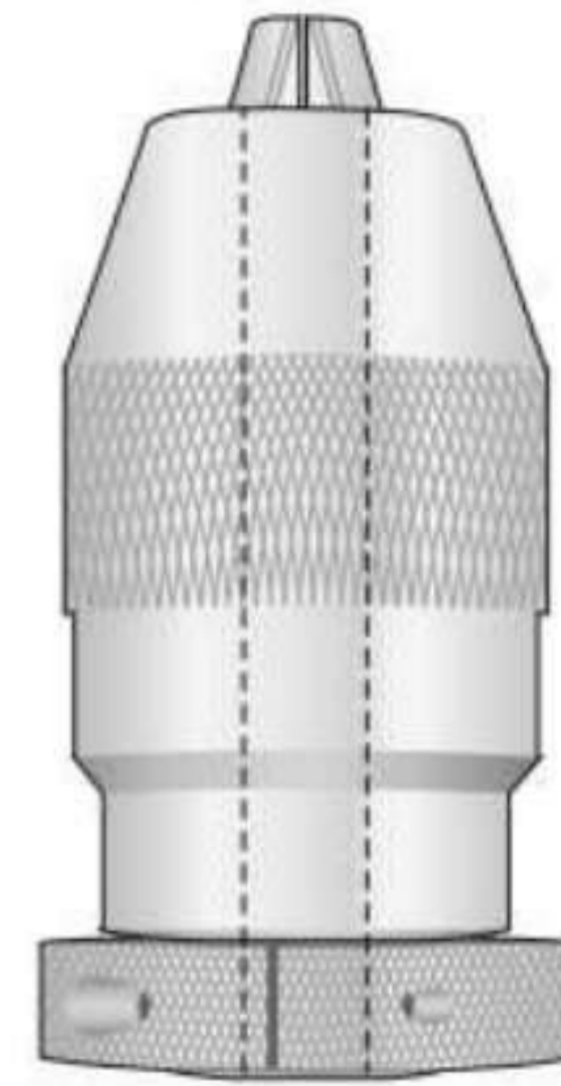

LS-224

Inox
Ap. 6,3 mm

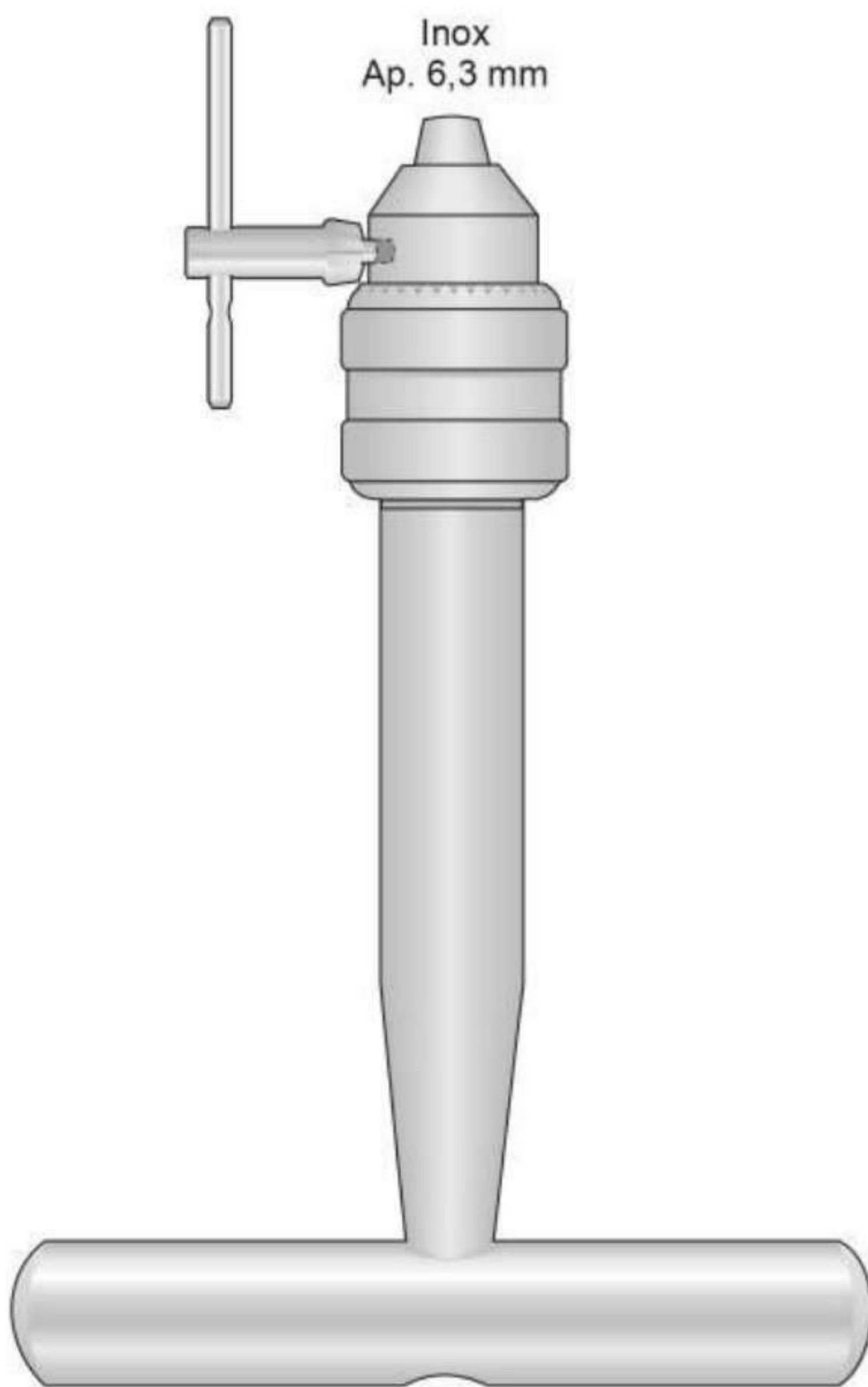

LS-230
130 mm

Inox
Ap. 7 mm

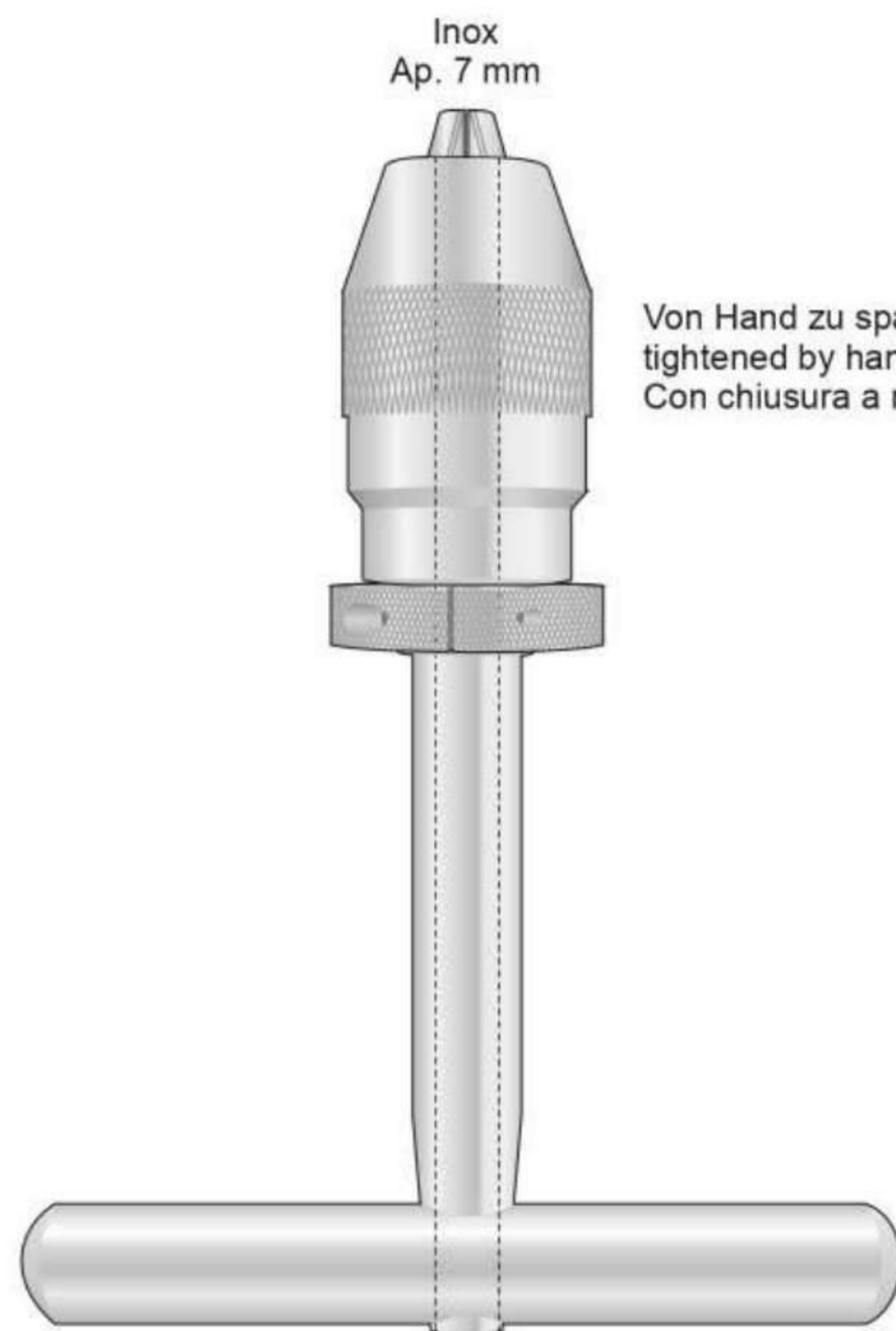

LS-234
135 mm

Von Handt zu spannen
tightened by hand
Con chiusura a mano

FR-20

FR-21 FR-22 + FR-23 FR-24 FR-25 FR-26
 Komplet, mit Fräsern Fig. 1-4 und Verlängerungsstück
 Complete, with burrs no. 1-4 and extension piece
 Completo, con frese Fig. 1-4 e giunto di prolungamento
 Completo, con fresas no. 1-4 y pieza de prolongación
 Complet, avec fraises no. 1-4 et pièce de rallonge



Verlängerungsstück
 Extension Piece
 Giunto di prolungamento
 Pieza de prolongación
 Pièce de rallonge

HUDSON
FR-22

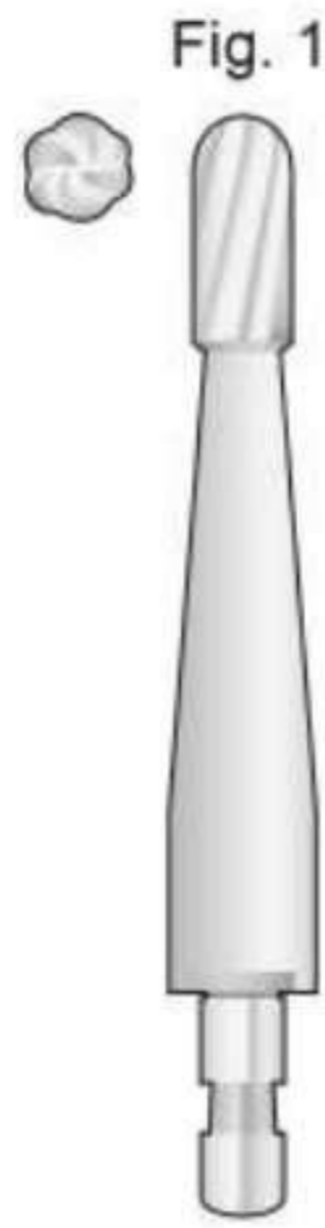

HUDSON
FR-23
 Ø 9 mm

Kegelfräser
 Conical Burr
 Fresa cuneiforme
 Fresa cónica
 Fraise conique



HUDSON
FR-24
 Ø 14 mm

Kegelfräser
 Conical Burr
 Fresa cuneiforme
 Fresa cónica
 Fraise conique



HUDSON
FR-25
 Ø 16 mm

Kugelfräser
 Spherical Burr
 Fresa sferica
 Fresa esférica
 Fraise spherique



HUDSON
FR-26
 Ø 22 mm

Kugelfräser
 Spherical Burr
 Fresa sferica
 Fresa esférica
 Fraise spherique

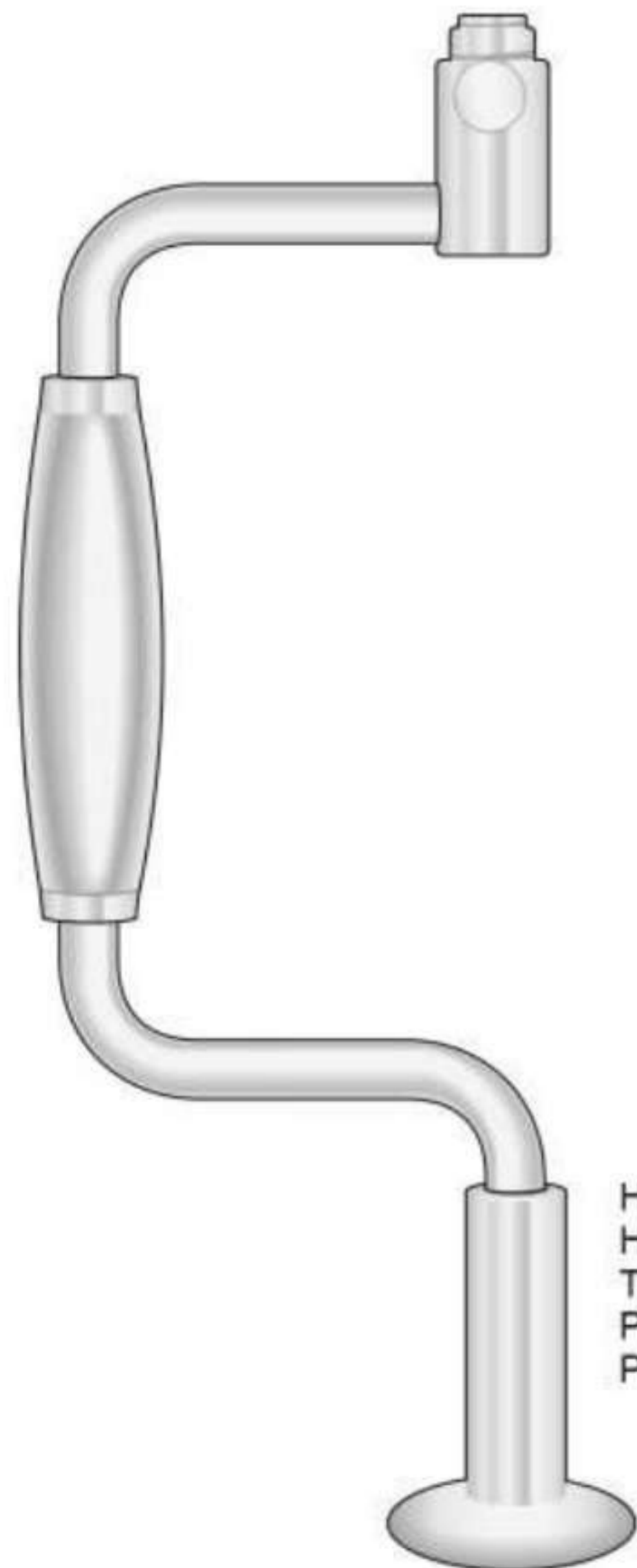

HUDSON
FR-21
 280 mm

Handbohr allein
 Hand drill only
 Trapano solo
 Perforador suelto
 Perforateur seul

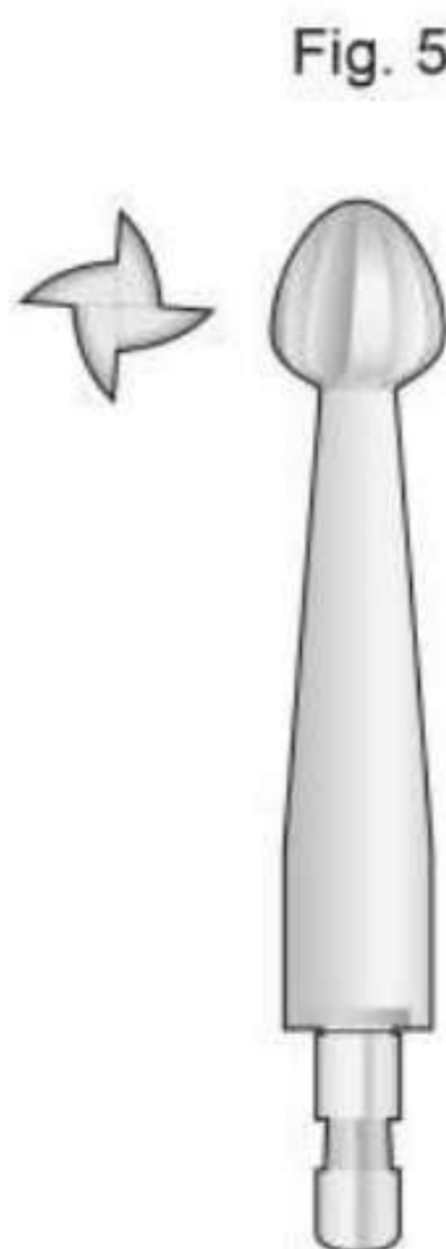

ADSON
FR-27
 Ø 15 mm

Bohrer
 Burr
 Punta
 Fresa
 Fraise



Mc KENZIE
FR-28
 Ø 13 mm

Bohrer
 Burr
 Punta
 Fresa
 Fraise



CUSHING
FR-29
 Ø 14 mm

Flachbohrer
 Flat Trephine
 Trapano piatto
 Taladro plano
 Fraise plate



FR-30
 Ø 2 mm

Spiralbohrer
 Twist Drill
 Punta a spirale
 Broca espiral
 Mèche hélicoïdale

Schraubendreher
Pfrieme

Screwdrivers
Awls

Cacciaviti
Punteruolo

Destornilladores
Lezna

Tournevis
Alêne

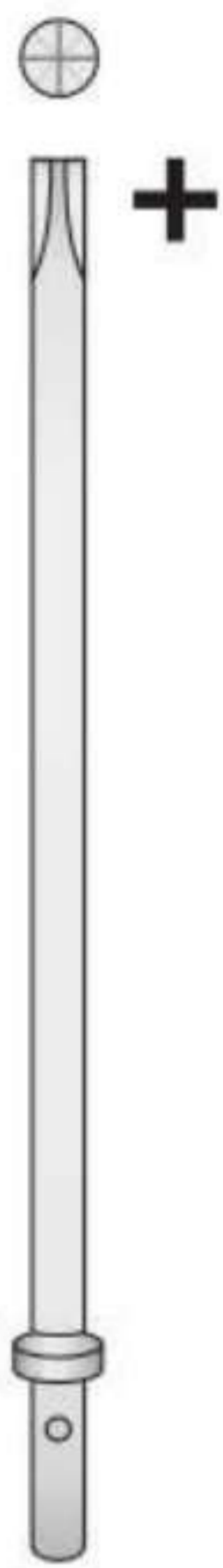

LS-321
140 mm

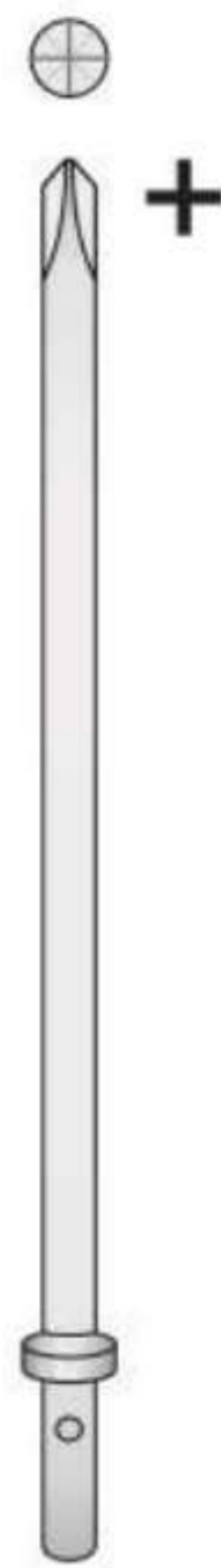

LS-322
140 mm



LS-323
140 mm



LS-324
140 mm

2,5 mm

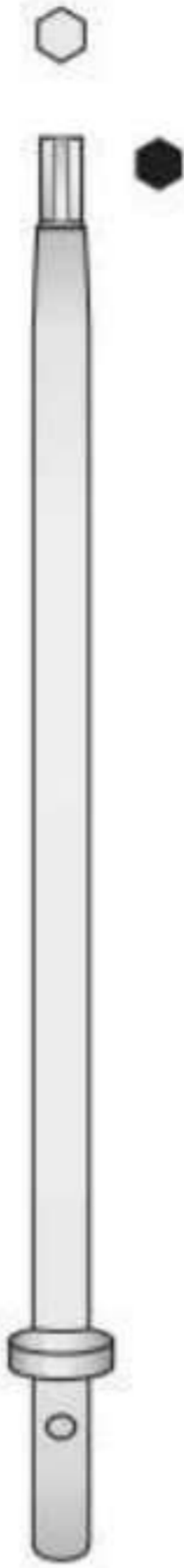

LS-325
140 mm

3,5 mm



LS-326
140 mm



TR-77
140 mm

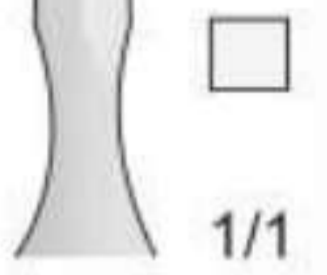

LS-330
(LS-321 + LS-322 + LS-323 + LS-324 + LS-325 + LS-326 + LS-329)
Schraubenzieher, Set mit Etui / Box with screws driver / Scatola con set giraviti
Set de destornilladores / Boîte de jeu de tournevis

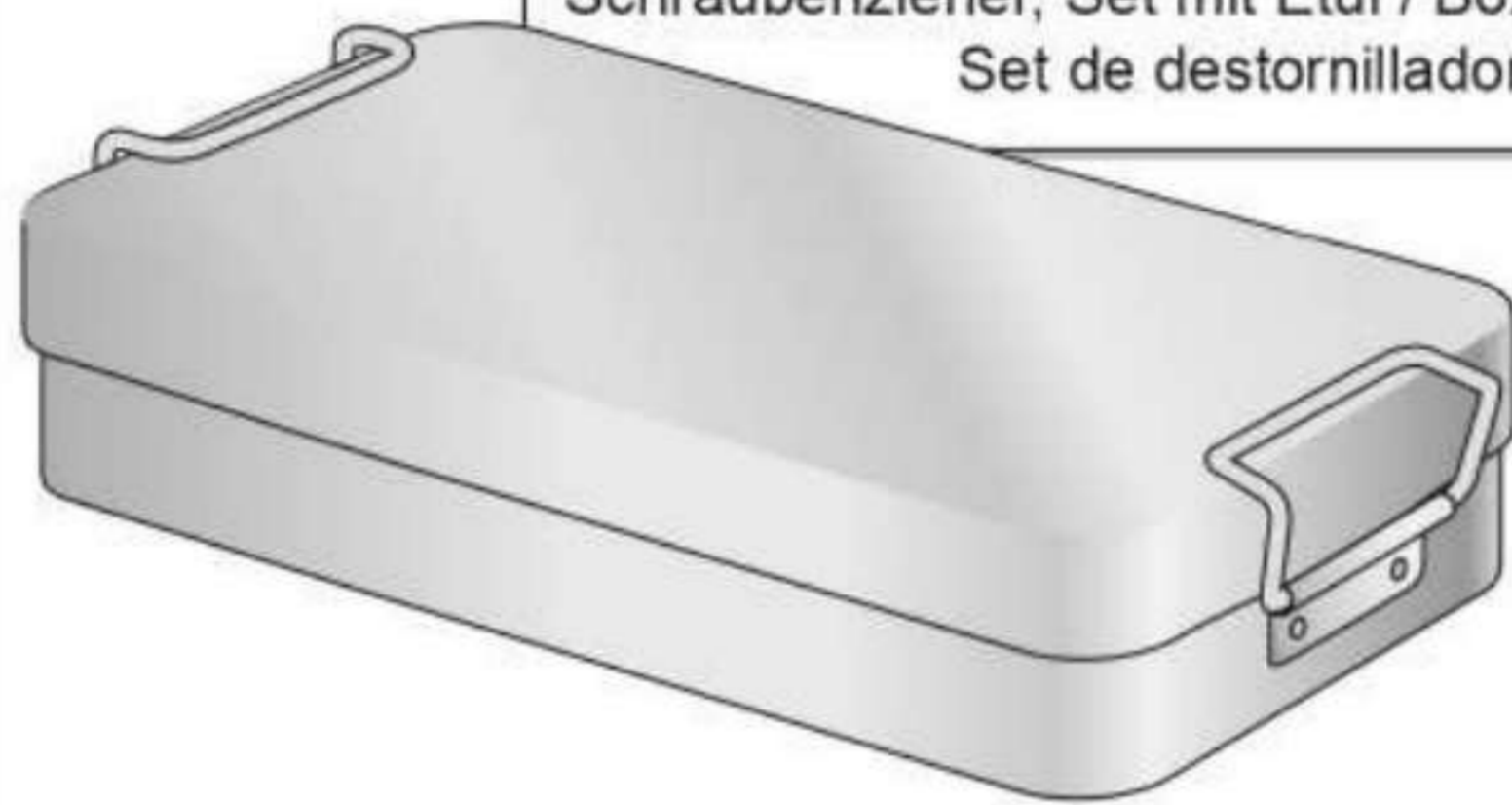

LS-329
200x100x40 mm
Etui allein / Box only / Solo scatola
Seul boîte / Caja sola



LS-320
145 mm

Max. Ø 6,3 mm



UNIVERSAL
LS-235
75 mm



LS-231
32 mm

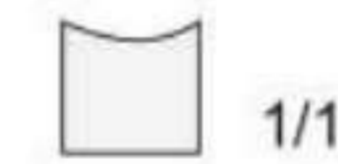
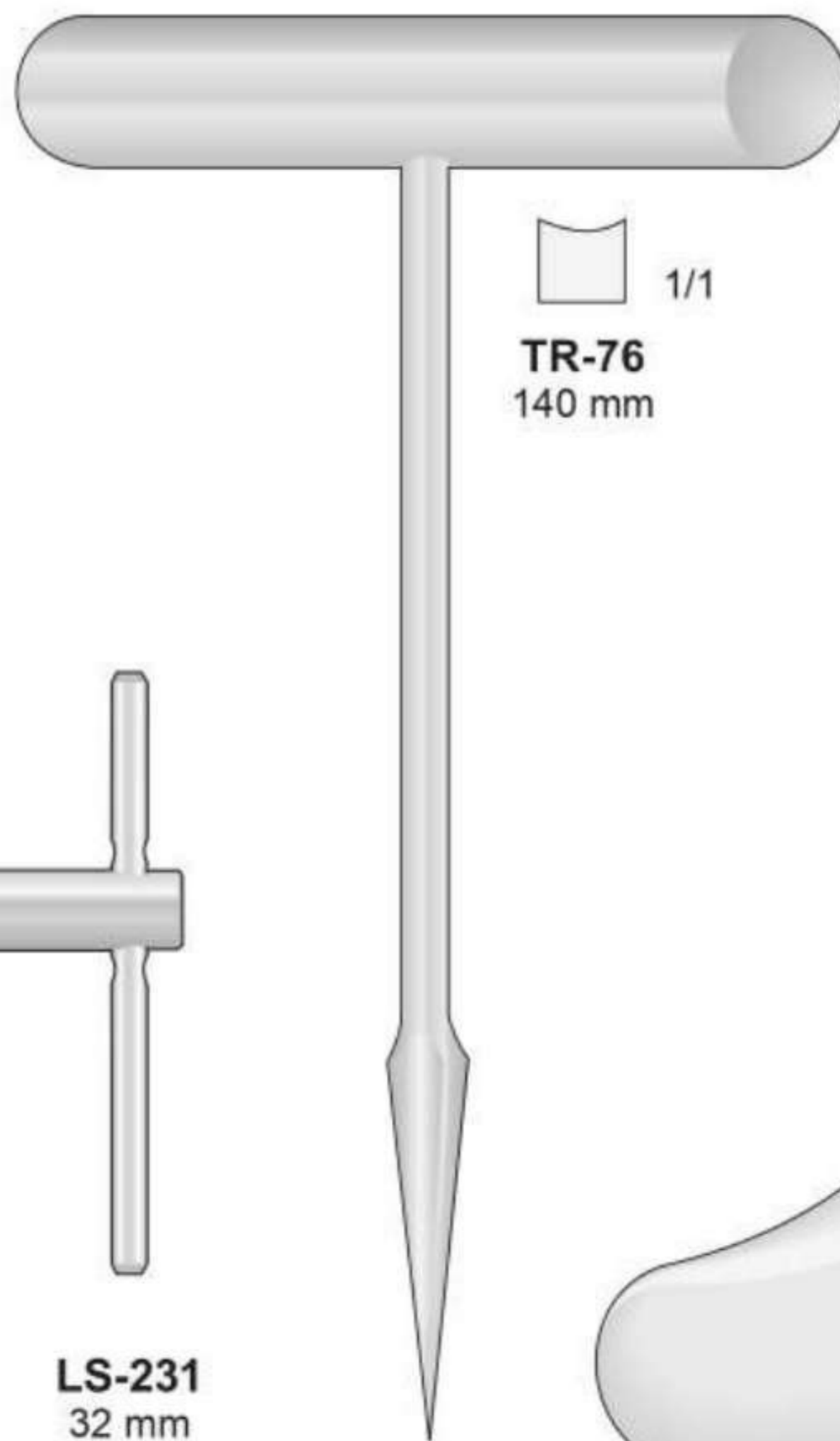

TR-76
140 mm

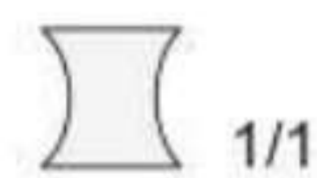
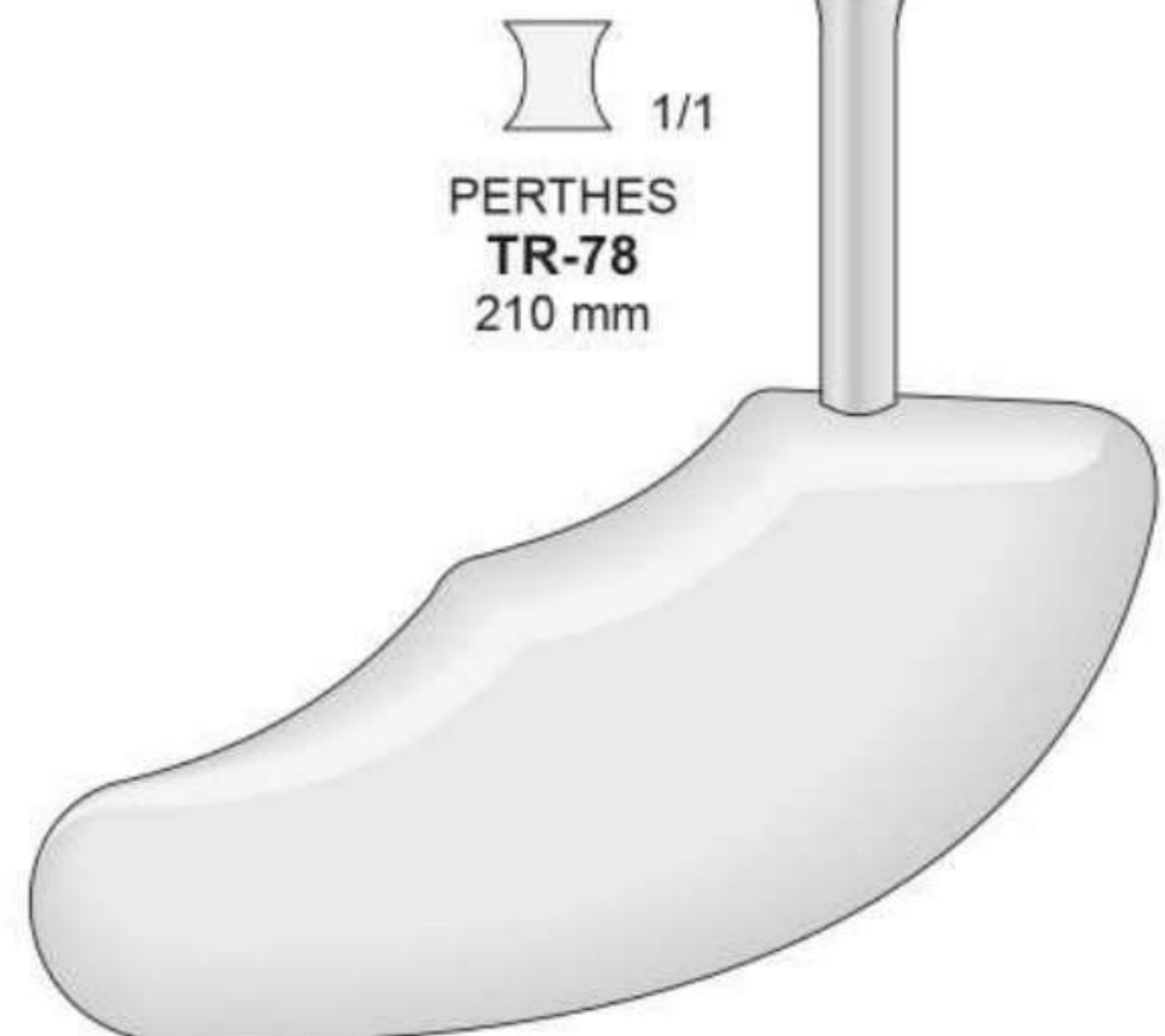

PERTHES
TR-78
210 mm

Schraubendreher
Osteosynthese

Screwdrivers
Osteosynthesis

Cacciaviti
Osteosintesi

Destornilladores
Osteosintesis

Tournevis
Ostéosynthèse

Schraubenzieher mit Ferrozellgriff
Screws driver with Ferrozell handle
Giraviti con manico di Ferrozell
Destornilladores con mango de Ferrozell
Jeu de tournevis avec poignée en Ferrozell

Schraubenzieher mit Ferrozellgriff
Screws driver with Ferrozell handle
Giraviti con manico di Ferrozell
Destornilladores con mango de Ferrozell
Jeu de tournevis avec poignée en Ferrozell

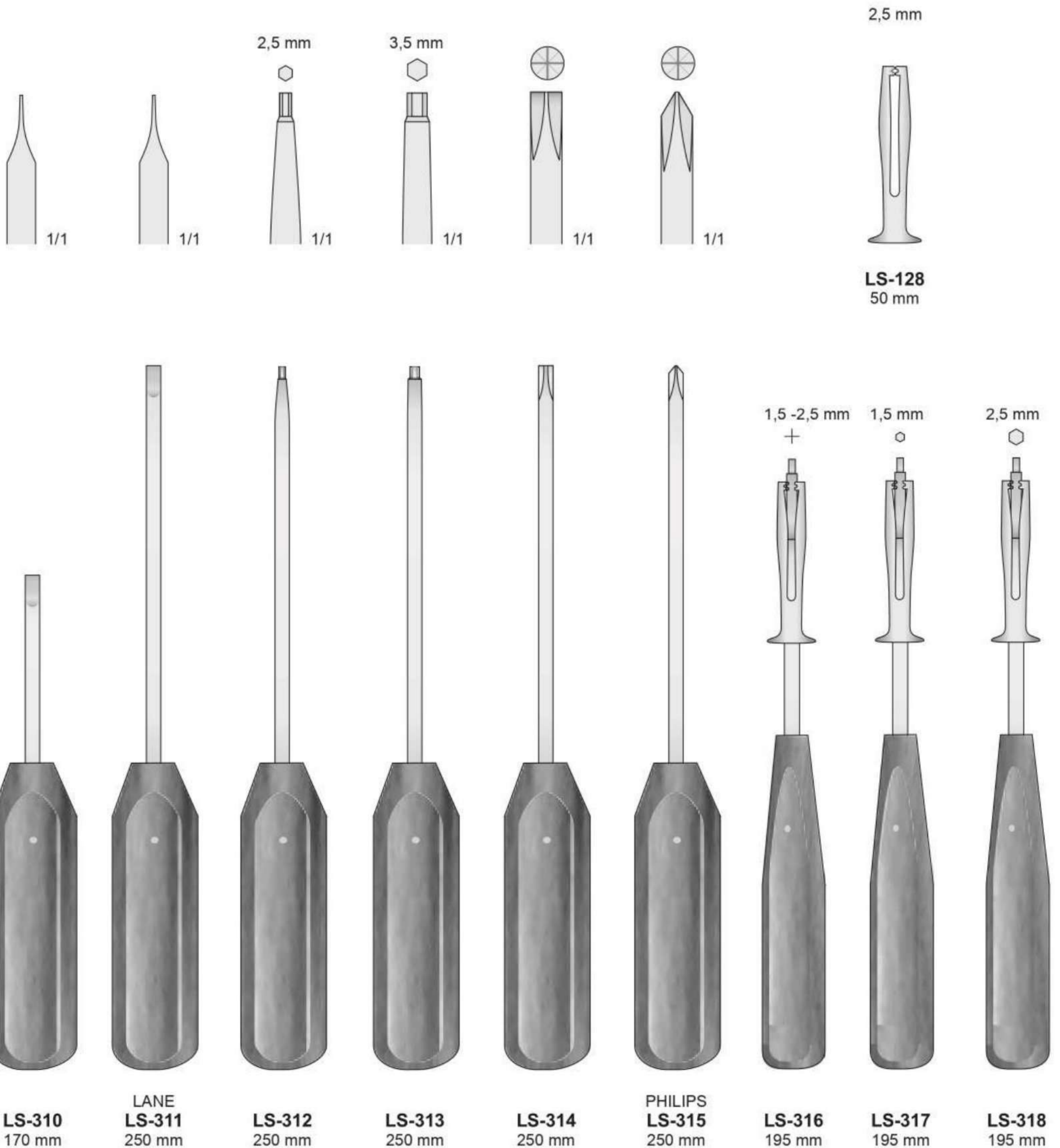

Drahtinstrumentarium
Wire instrument set
Strumenti per filo di cerchiaggio
Instrumental para cerclaje
Instruments à fil

Draht weich
Wire soft
Filo malleabile
per compattare l'osso
Alambre ligadura
Fil à os



10 mt.

Ø/Diam.	Codice
0,2 mm	KI-202
0,3 mm	KI-203
0,4 mm	KI-204
0,5 mm	KI-205
0,6 mm	KI-206
0,7 mm	KI-207
0,8 mm	KI-208
0,9 mm	KI-209
1,0 mm	KI-210
1,2 mm	KI-211
1,5 mm	KI-212

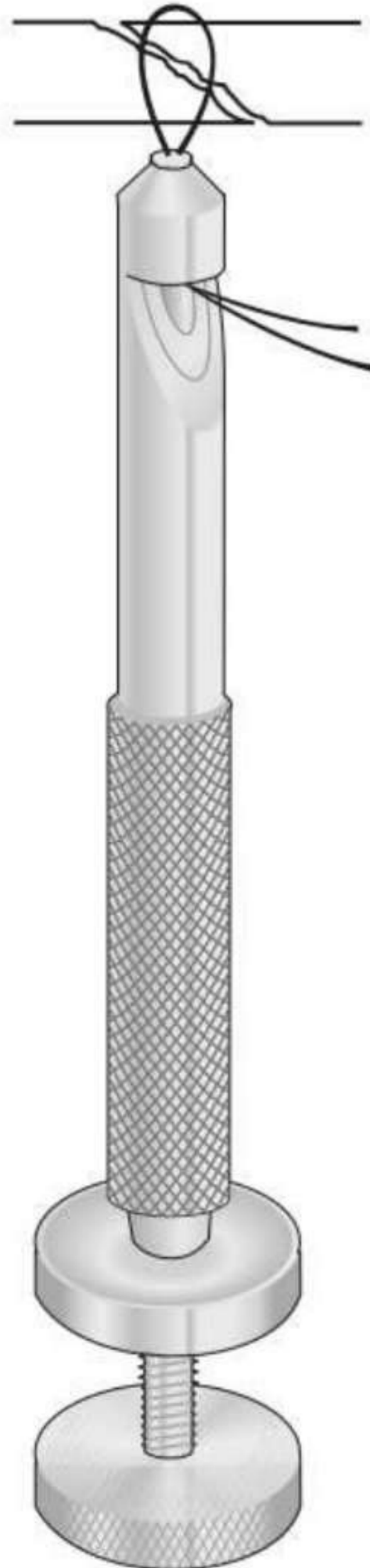

LOUTE
KI-322
220 mm

Drahtspanninstrument
Bone wire tighteners
Strumenti tendifili
Tensor cierra-hilos
Tendeur serre fils

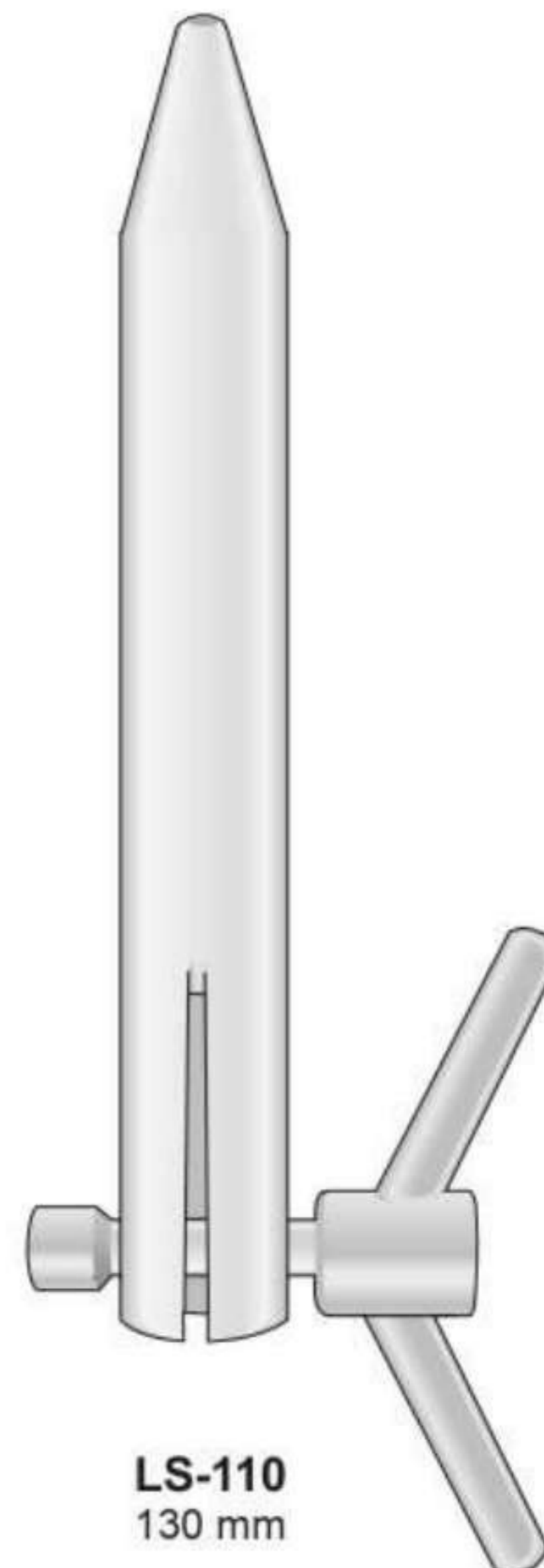

LS-110
130 mm

Bohrbüchsen zu Knochenplatten - Drill guides - Centrori guida punte - Guide méche

Codificazione del colore

verde = centrico
oro = eccentrico

Per trapano Ø 2,0 mm
Per viti da corticale Ø 2,7 mm

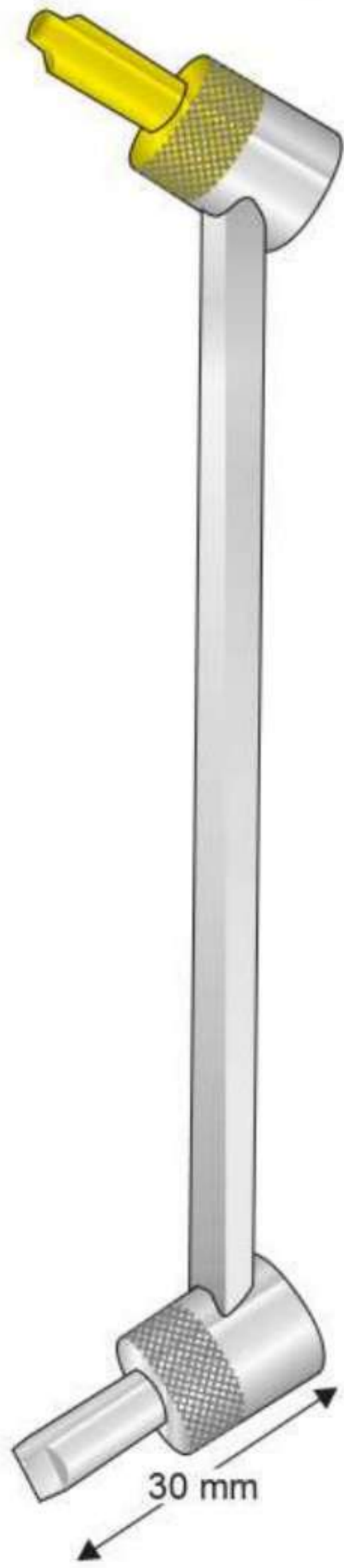

LS-91
140 mm

Per trapano Ø 2,5 mm
Per viti da corticale Ø 3,5 mm

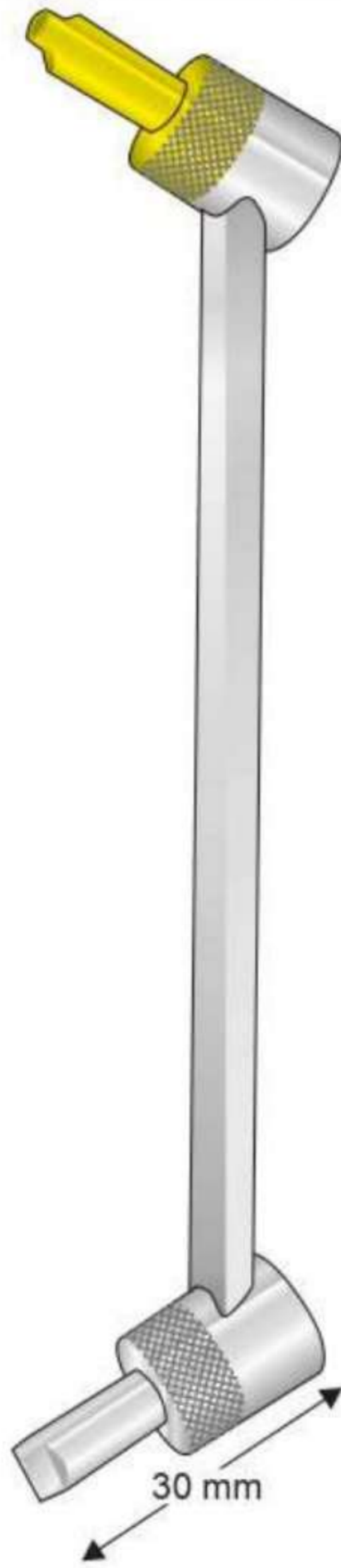

LS-90
140 mm

Per trapano Ø 3,2 mm
Per viti da corticale Ø 4,5 mm

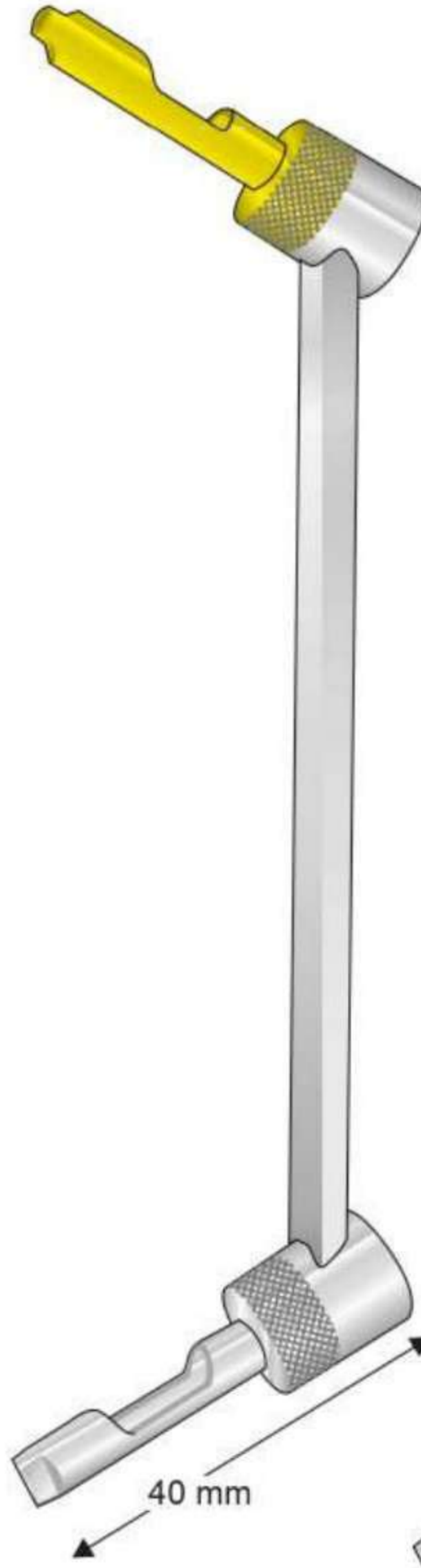

LS-92
165 mm

Per trapano Ø 3,2 mm
Per viti da corticale Ø 4,5 mm

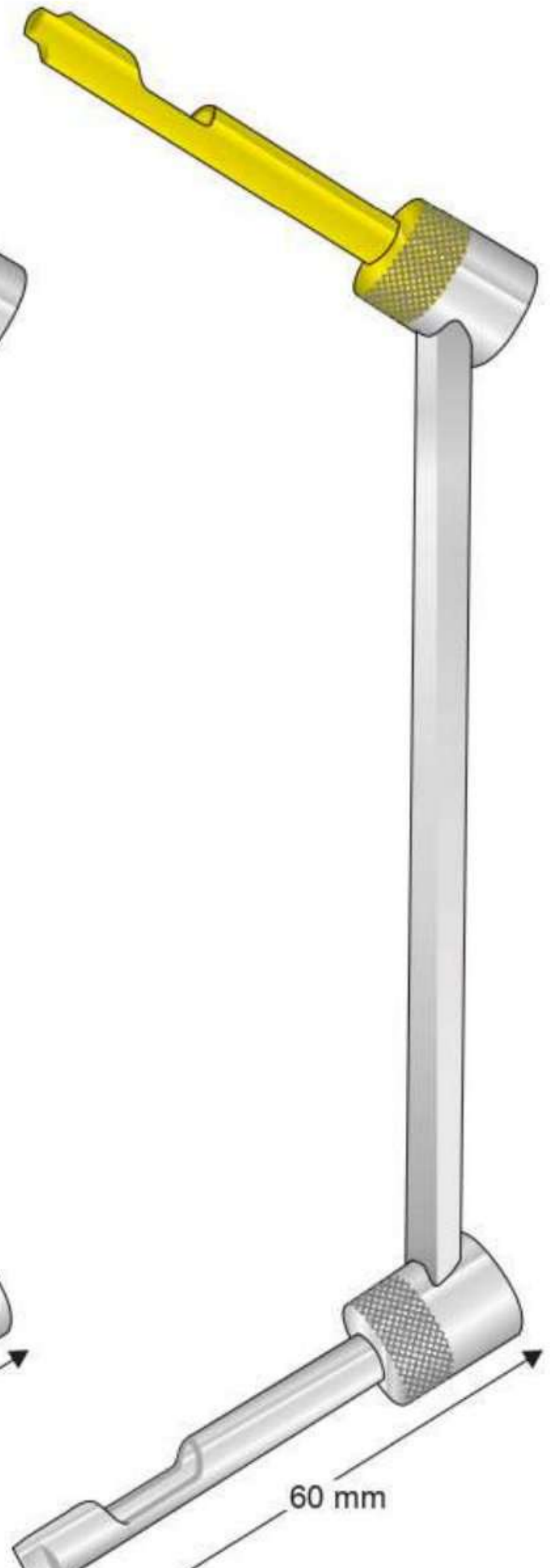

LS-93
170 mm

Osteosinthese

Osteosynthesis

Osteosintesi

Osteosíntesis

Ostéosynthèse

Bohrbüchsen zu Knochenplatten - Drill guides - Centrori guida punte - Guide méche



LS-73
120 mm



LS-74
120 mm



LS-75
120 mm

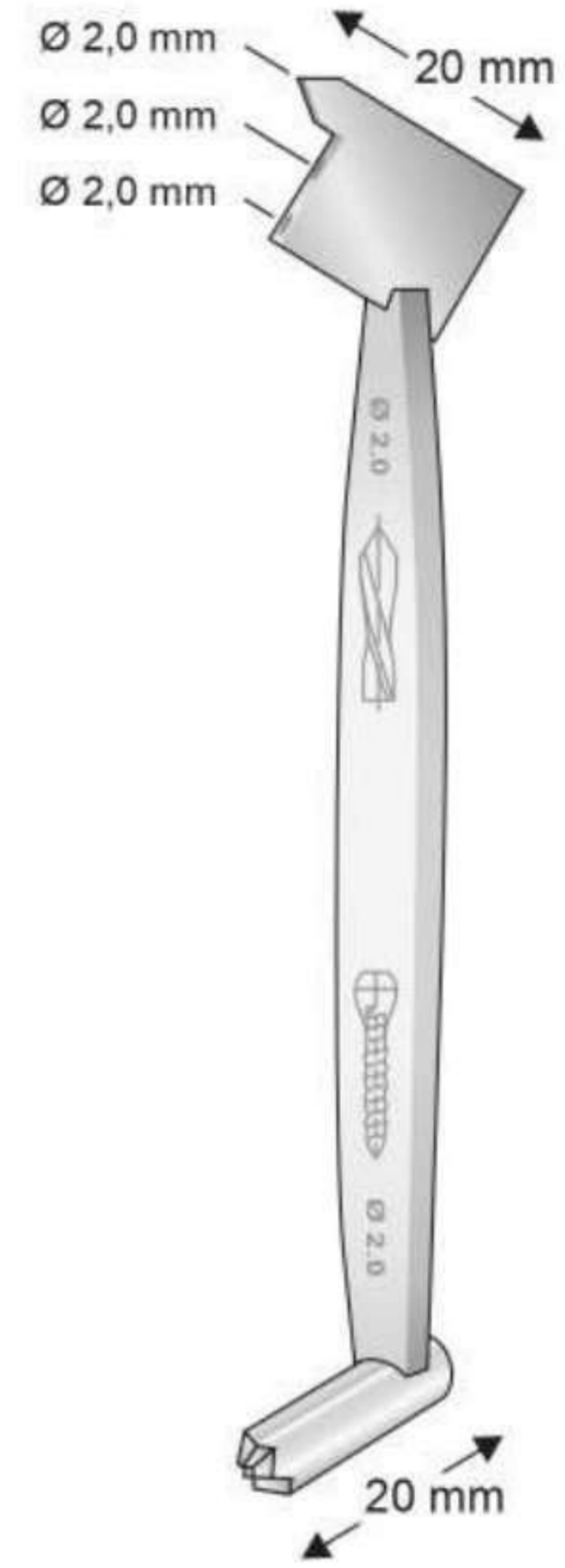

LS-80
110 mm

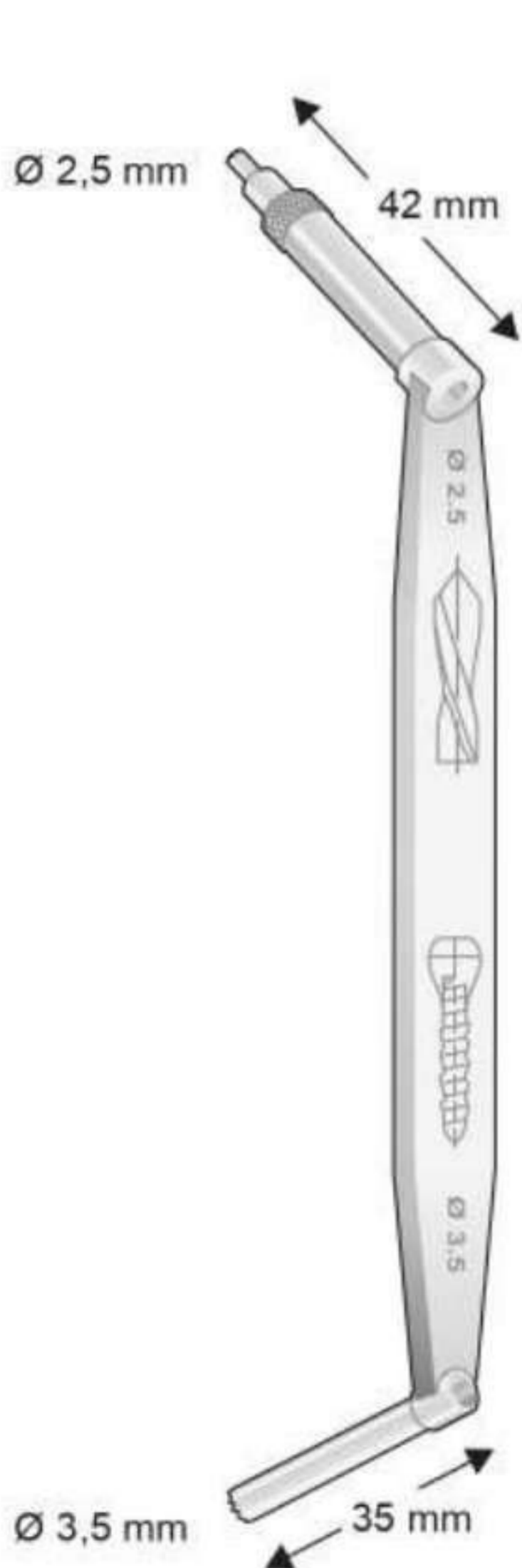

LS-81

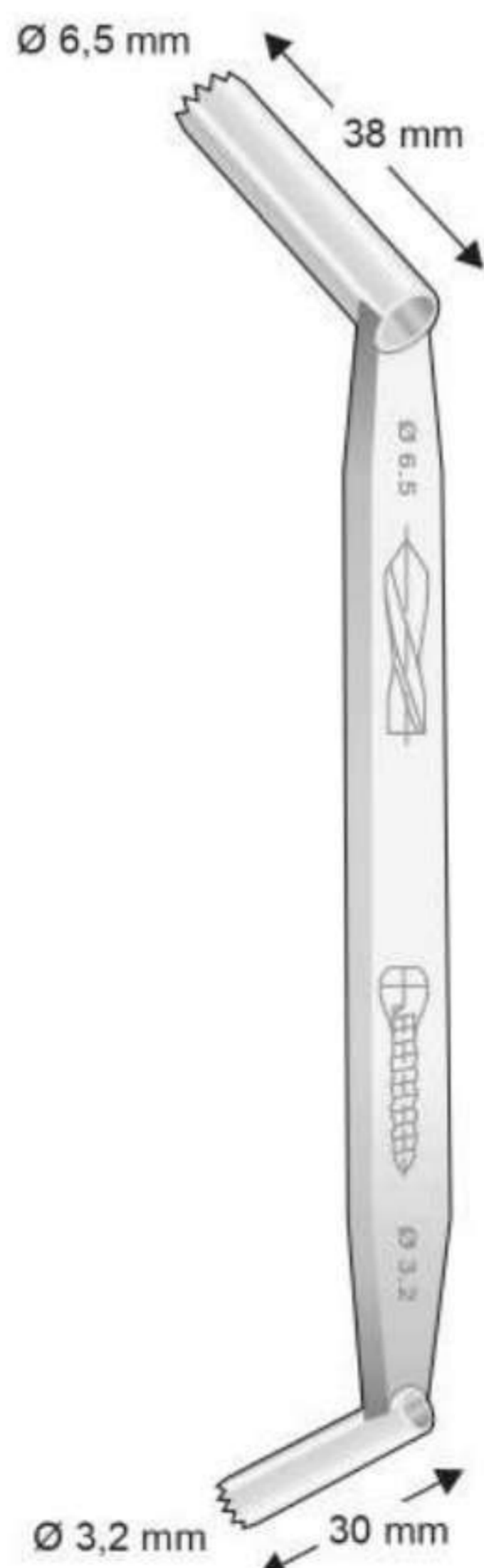

LS-82

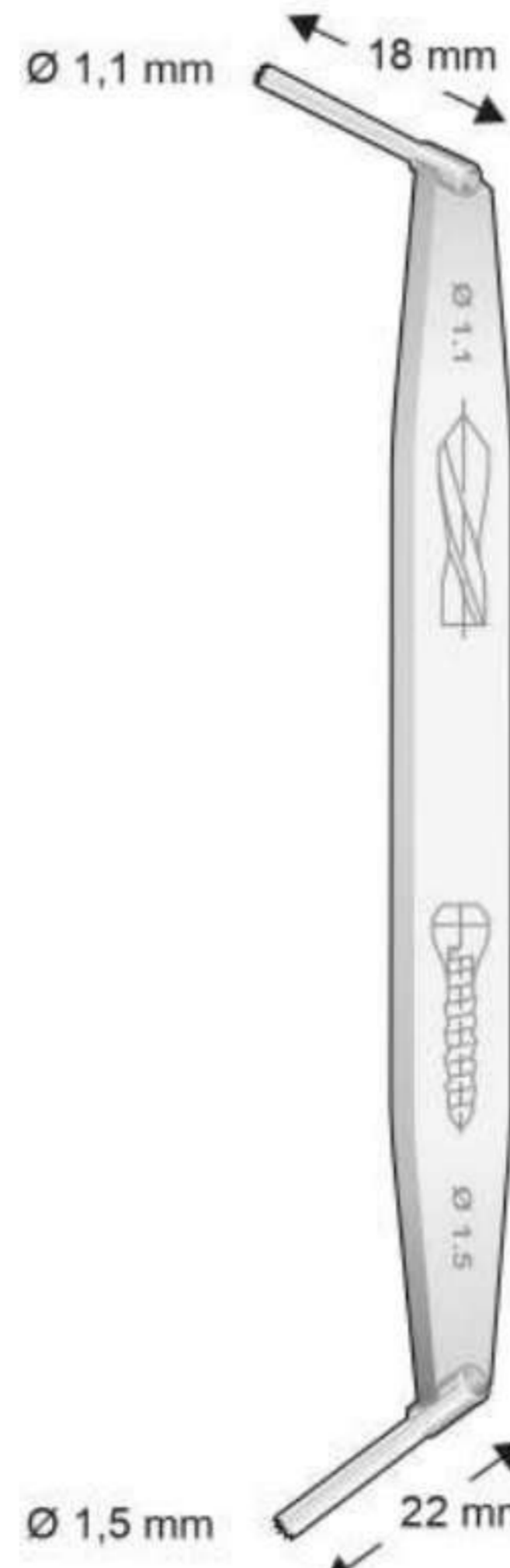

LS-83
105 mm

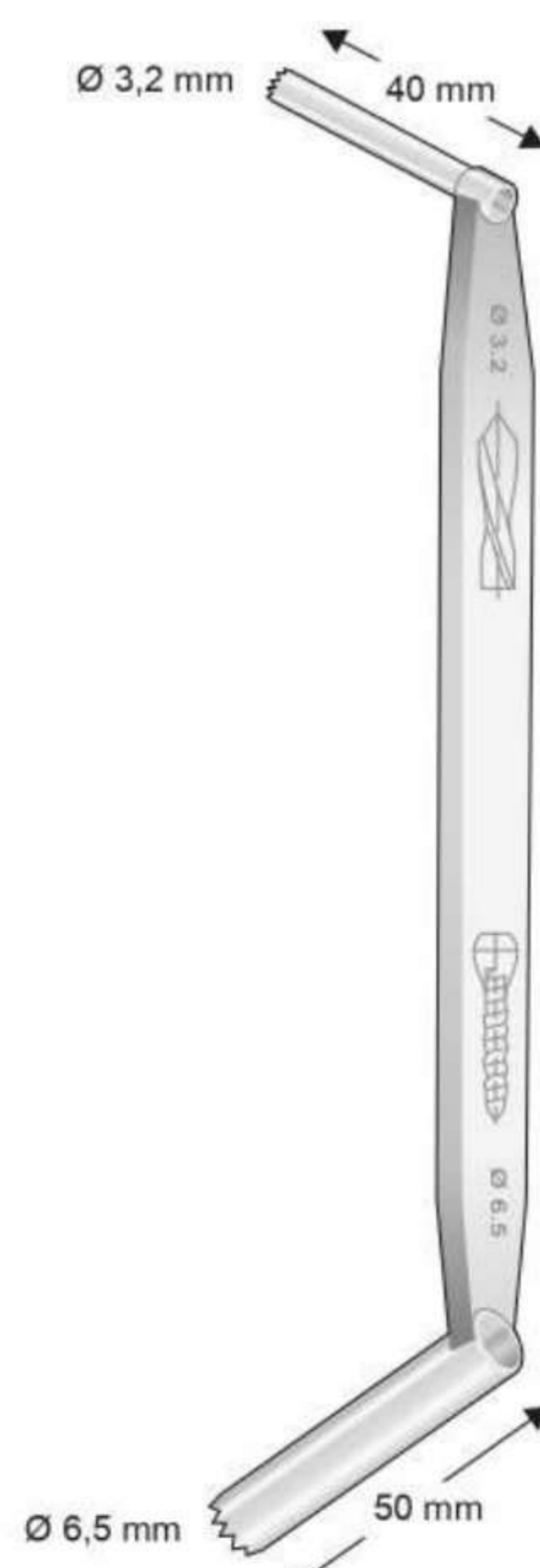

LS-84
160 mm



LS-85

Bohrbüchsen zu Knochenplatten - Drill guides - Centratori guida punte - Guide méche

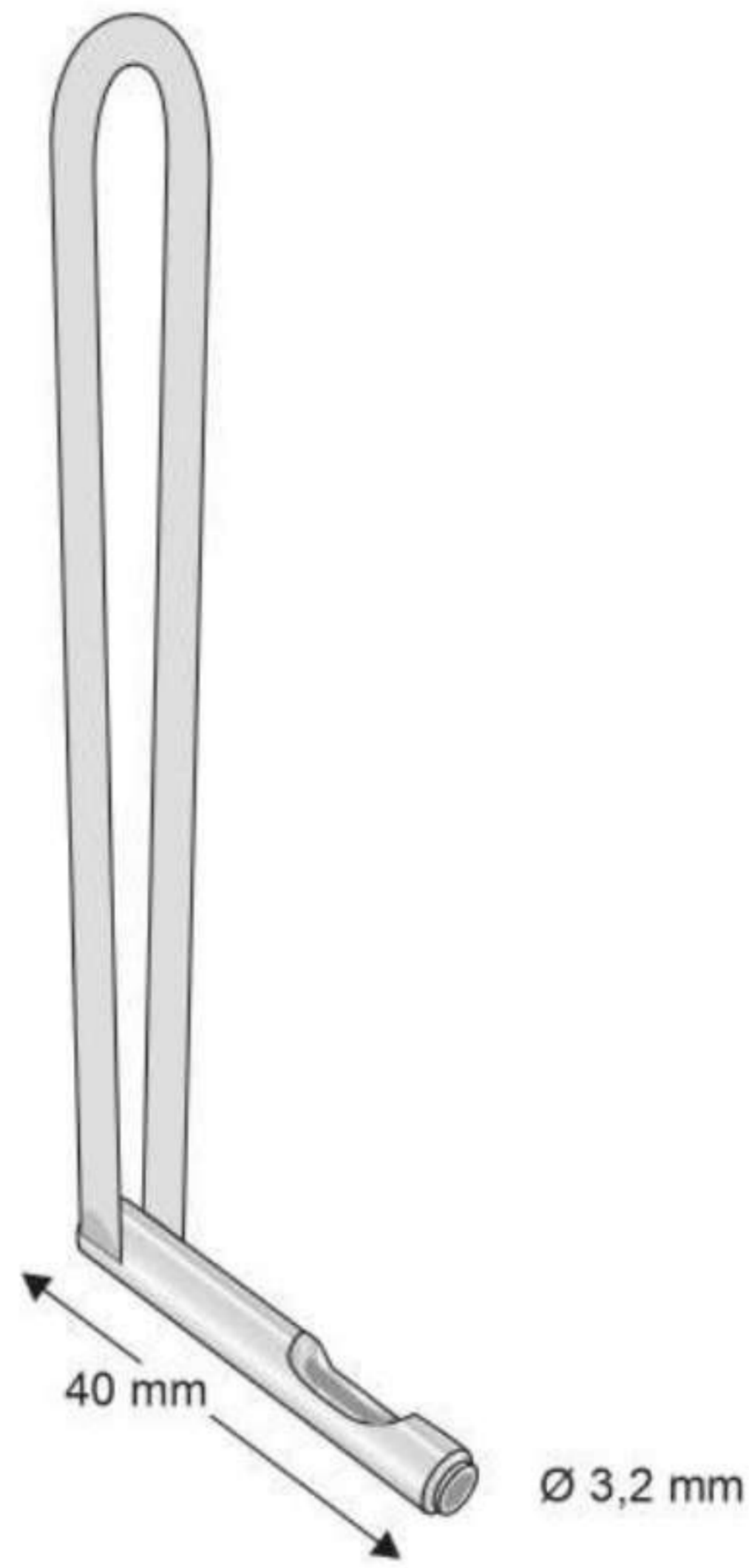

LS-117
125 mm

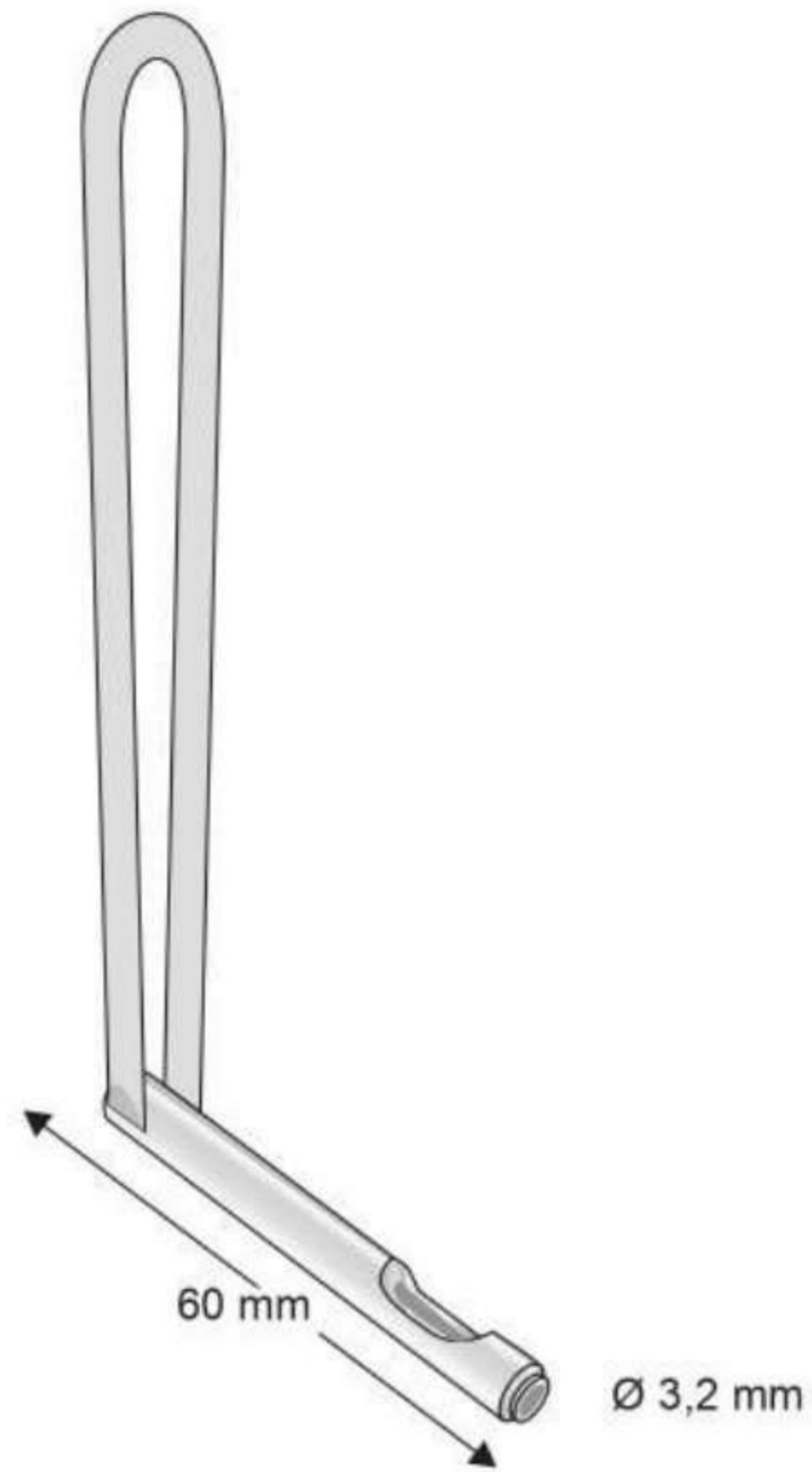

LS-124
125 mm

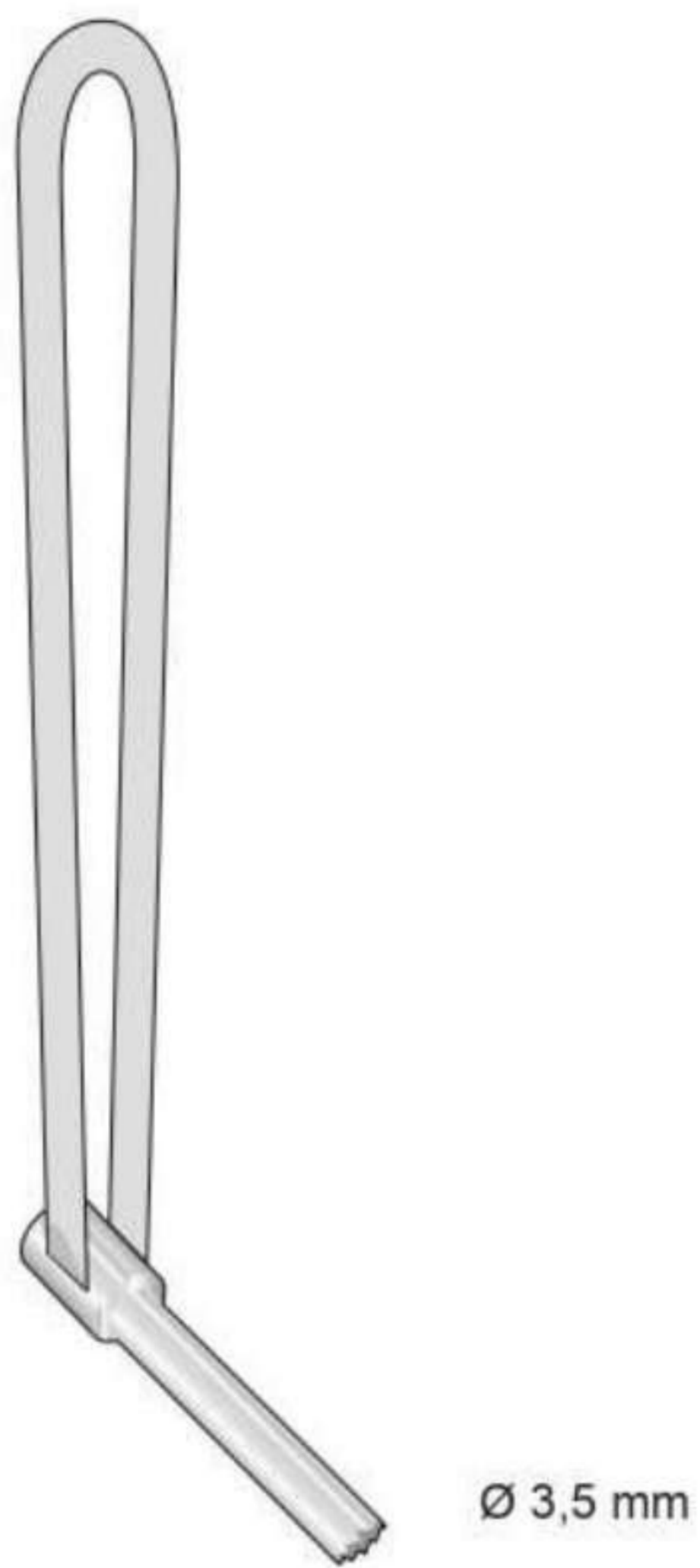

LS-116
125 mm

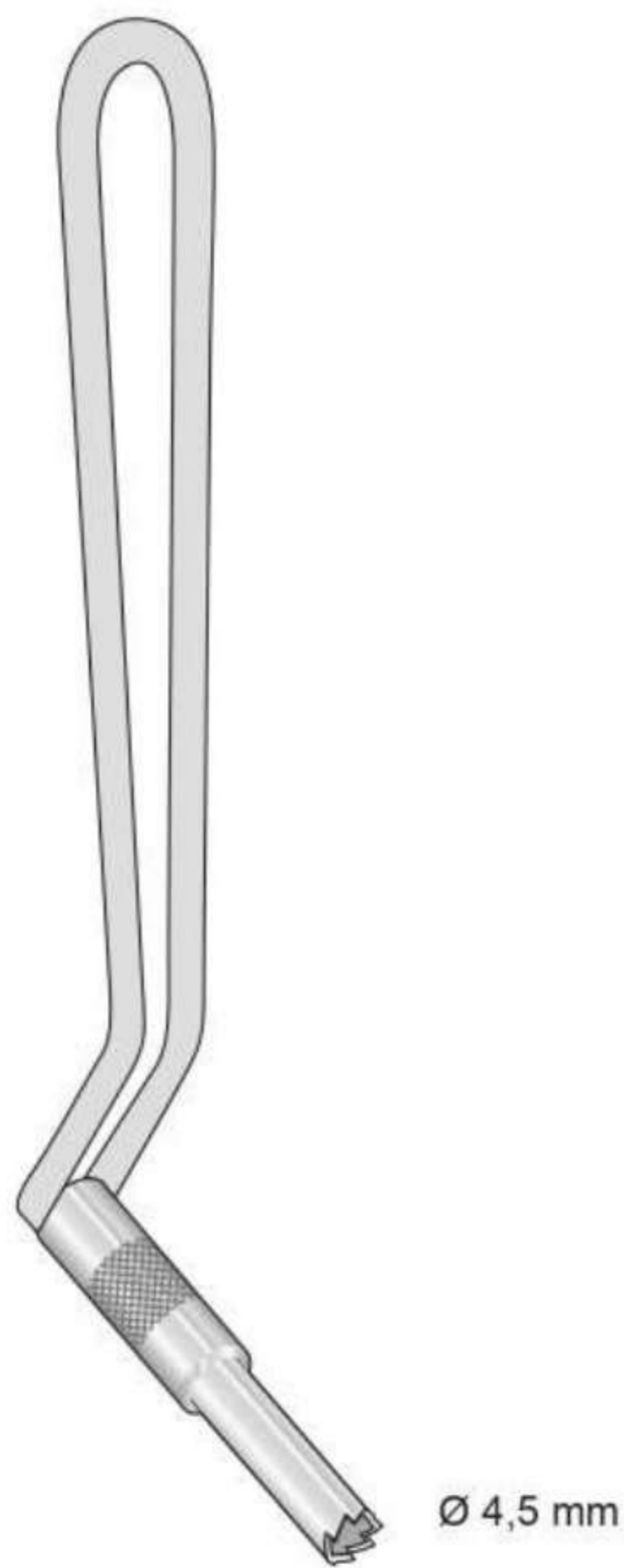

LS-119
150 mm

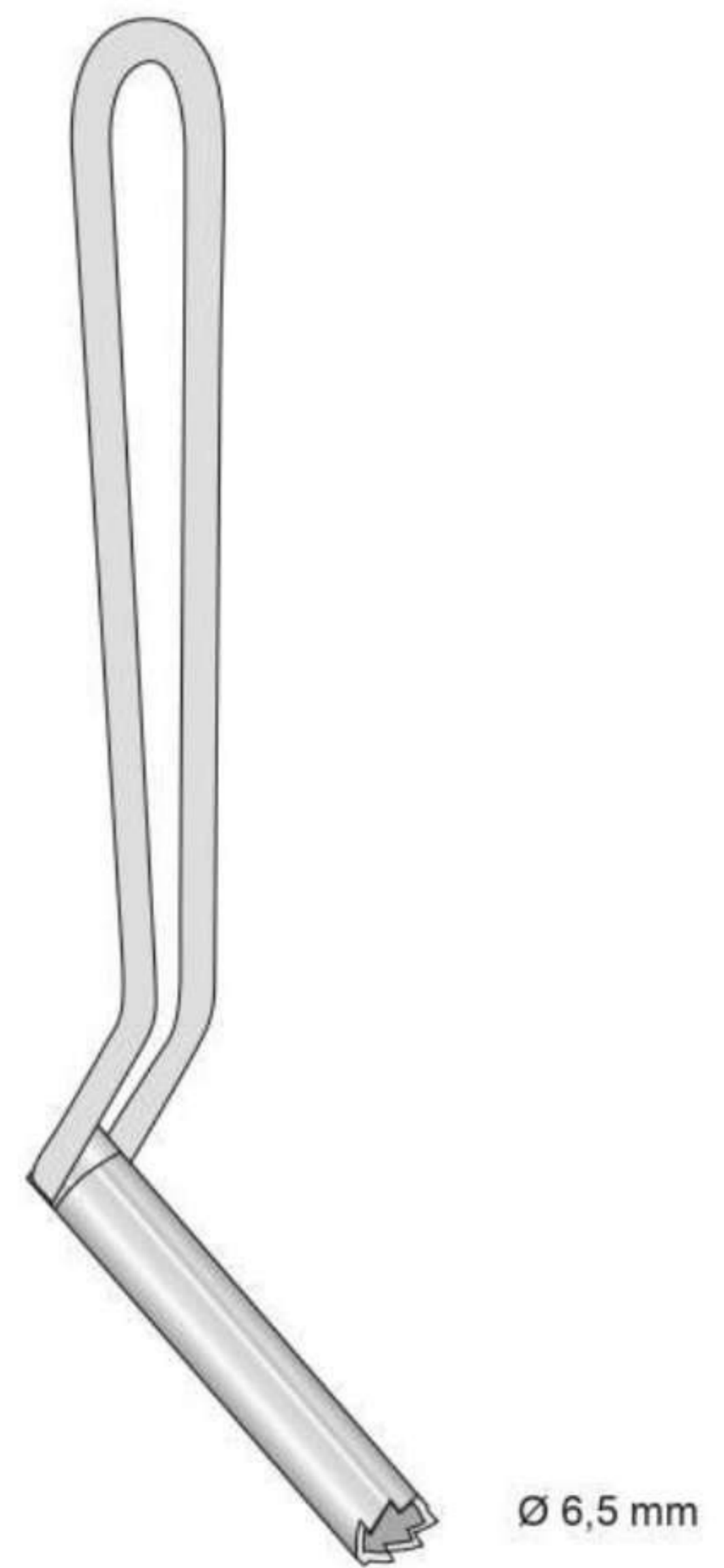

LS-121
150 mm

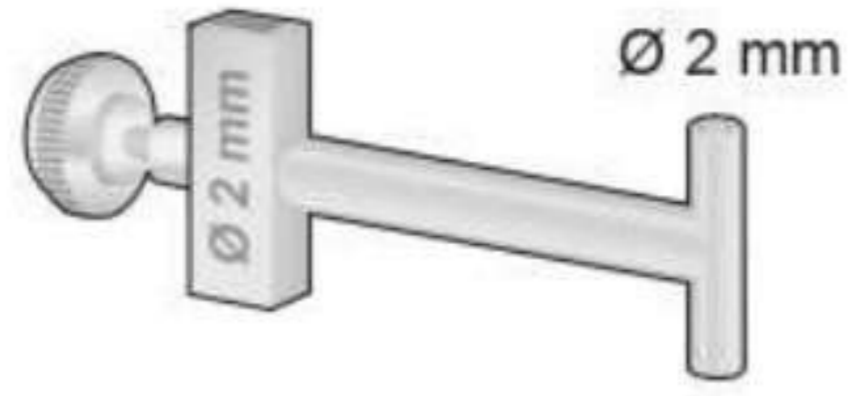

LS-96

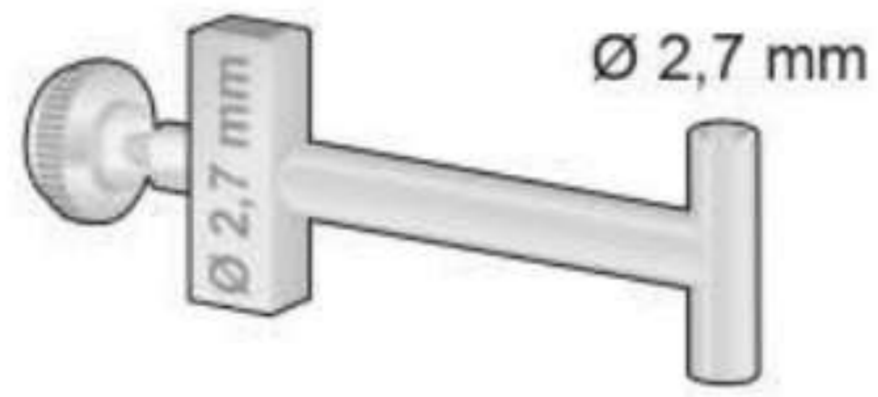

LS-97

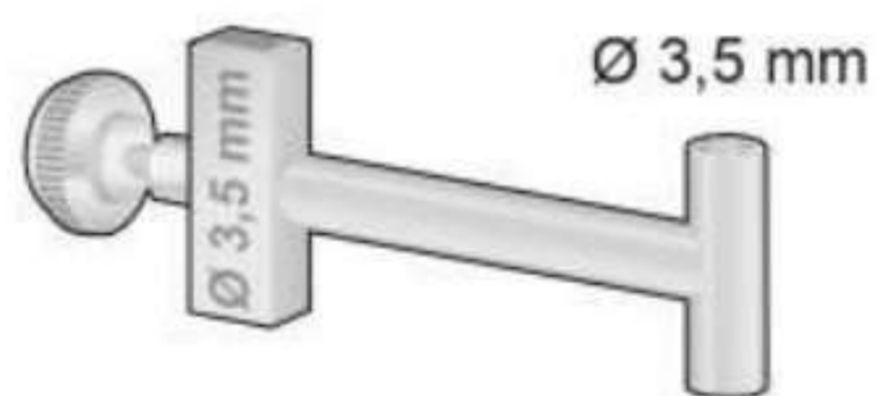

LS-98

LS-95
Complete with 3 guide
Completo di 3 guide
LS-94+LS-96+LS-97+LS-98

LS-94
Drill guide only
Centratore solo

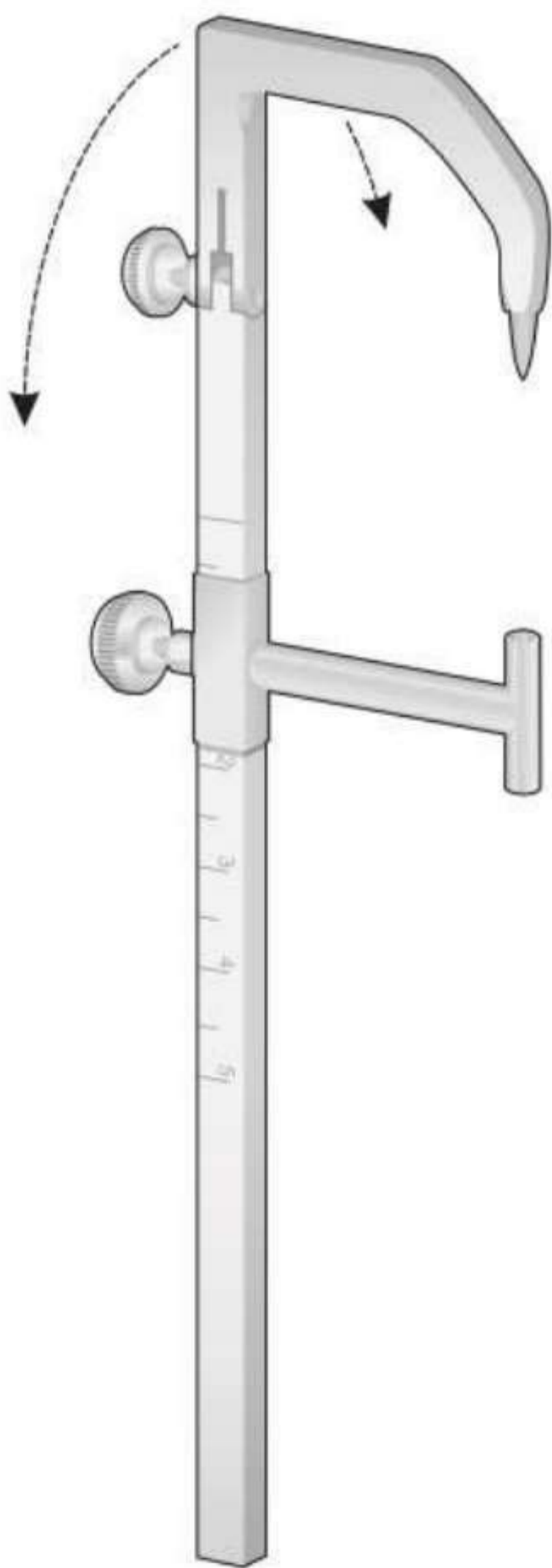

LS-95
145 mm

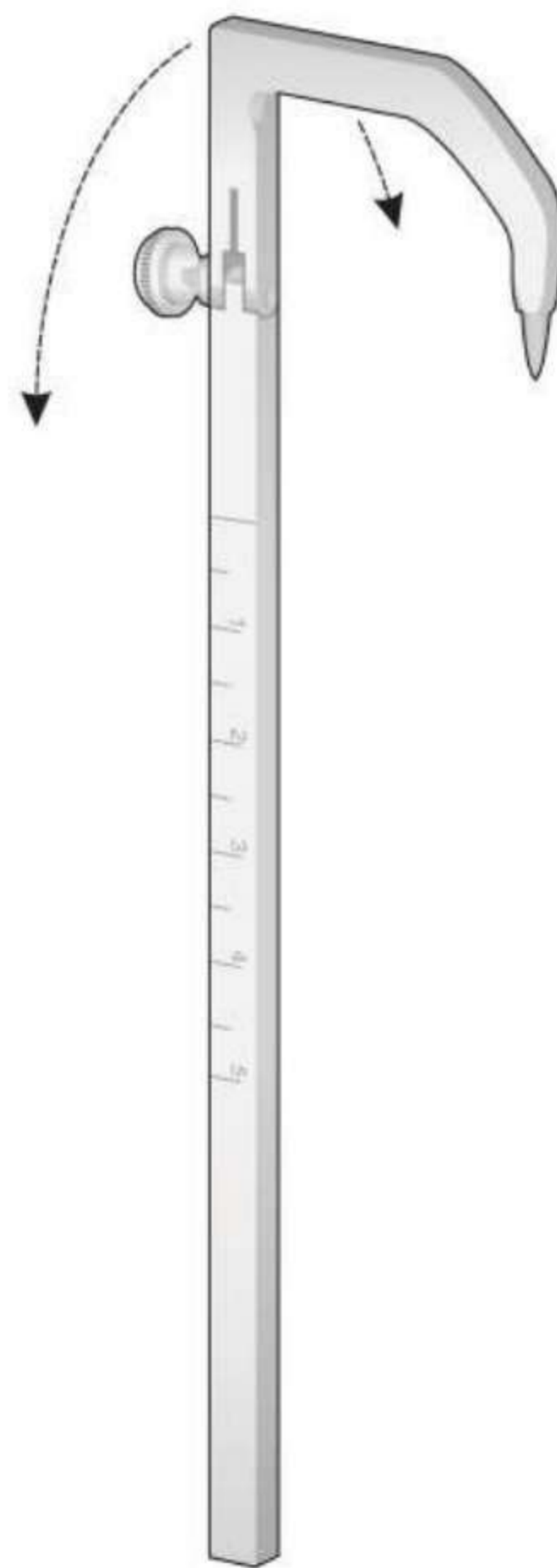

LS-94
145 mm

Steckbohrbüchsen
Manicotto dentato
Centrapunte
Insert-drill



Ø Außen	Ø Für Bohrer
Ø Outside	Ø For drills
Ø Esterno	Ø Per punte
Ø Exterior	Ø Para agujas
Ø Extérieur	Ø Pour Mèches

Cod. Art.	Ø Außen	Ø Für Bohrer
LS-113	4,5 mm	3,2 mm
LS-114	3,5 mm	2 mm
LS-115	3,5 mm	2,7 mm

Gewebeschutzhülsen
Guida per punte elicoidali

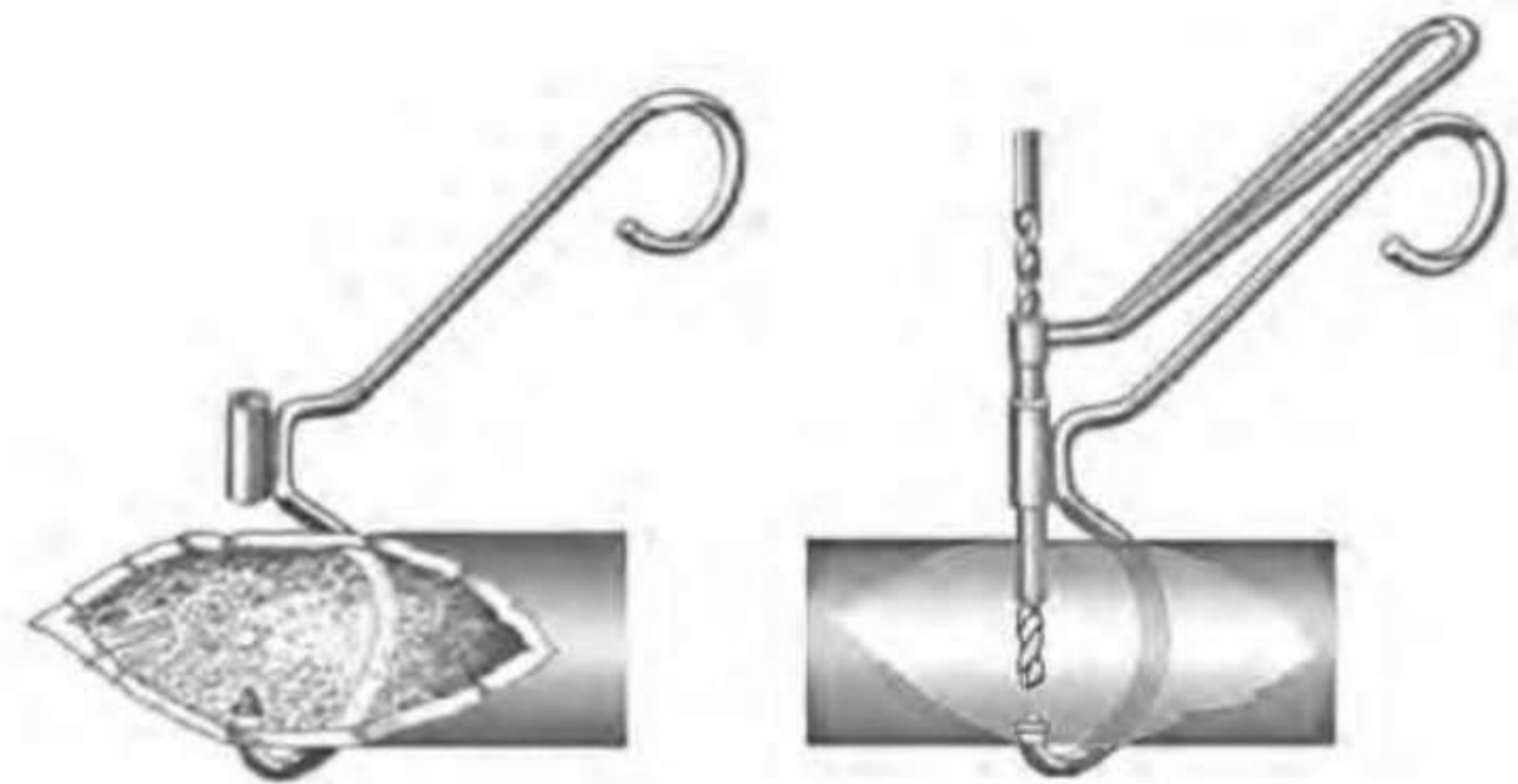

Innen Ø 6,5 mm
Inside Ø 6,5 mm
Interno Ø 6,5 mm
Interior Ø 6,5 mm
Intérieur Ø 6,5 mm

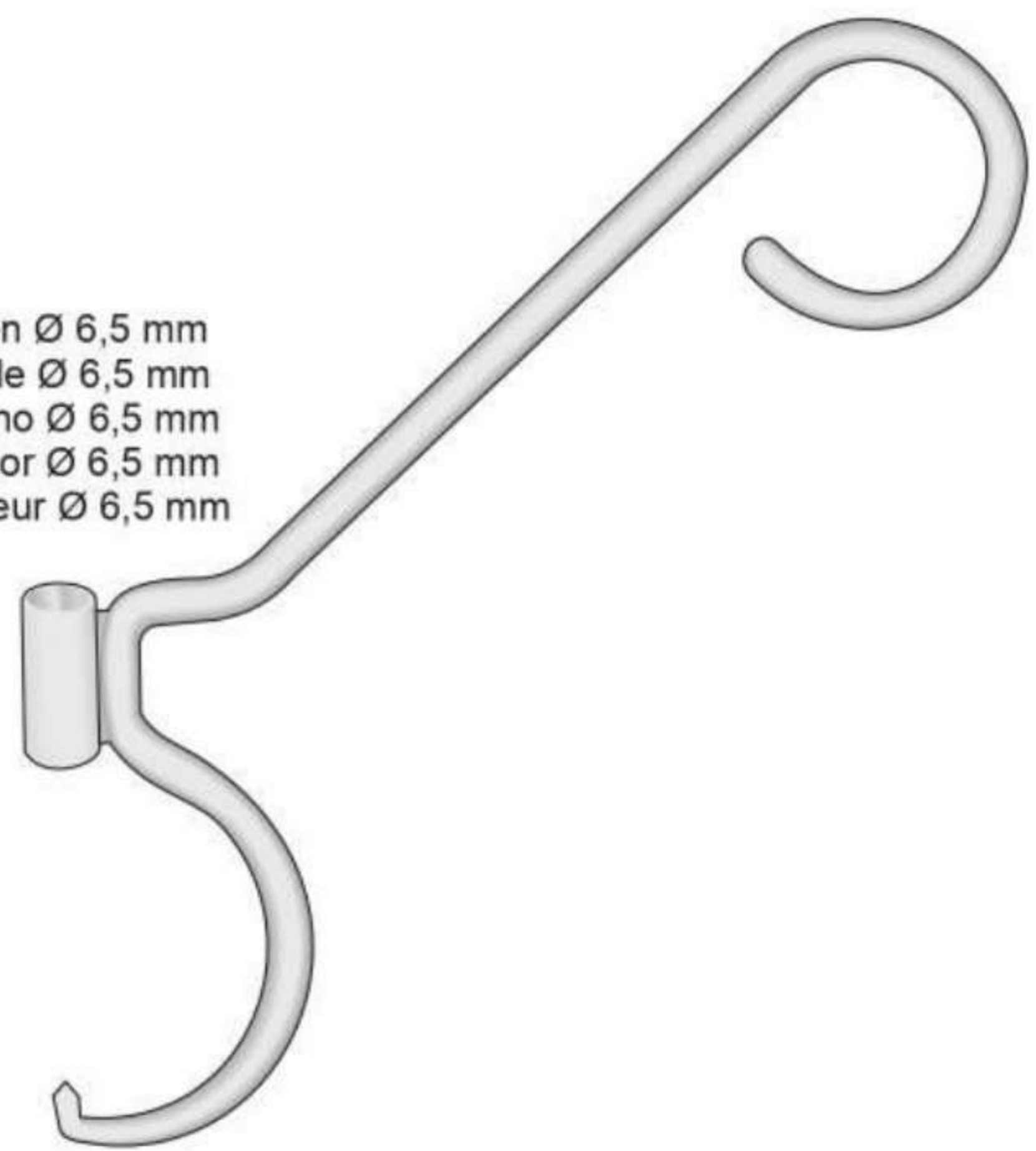

LS-112



TRS INSTRUMENTS

TRAUMATOLOGY AND ORTHOPAEDICS

Measuring Instruments
Messinstrumente
Instruments à mesurer
Instrumentos de medición
Strumenti per misura

Screw depth gauges, to select proper length of screw
Misuratore di lunghezza per viti
Instruments à mesurer dla longueur de vis
Instrumento para medir el largo del tornillo

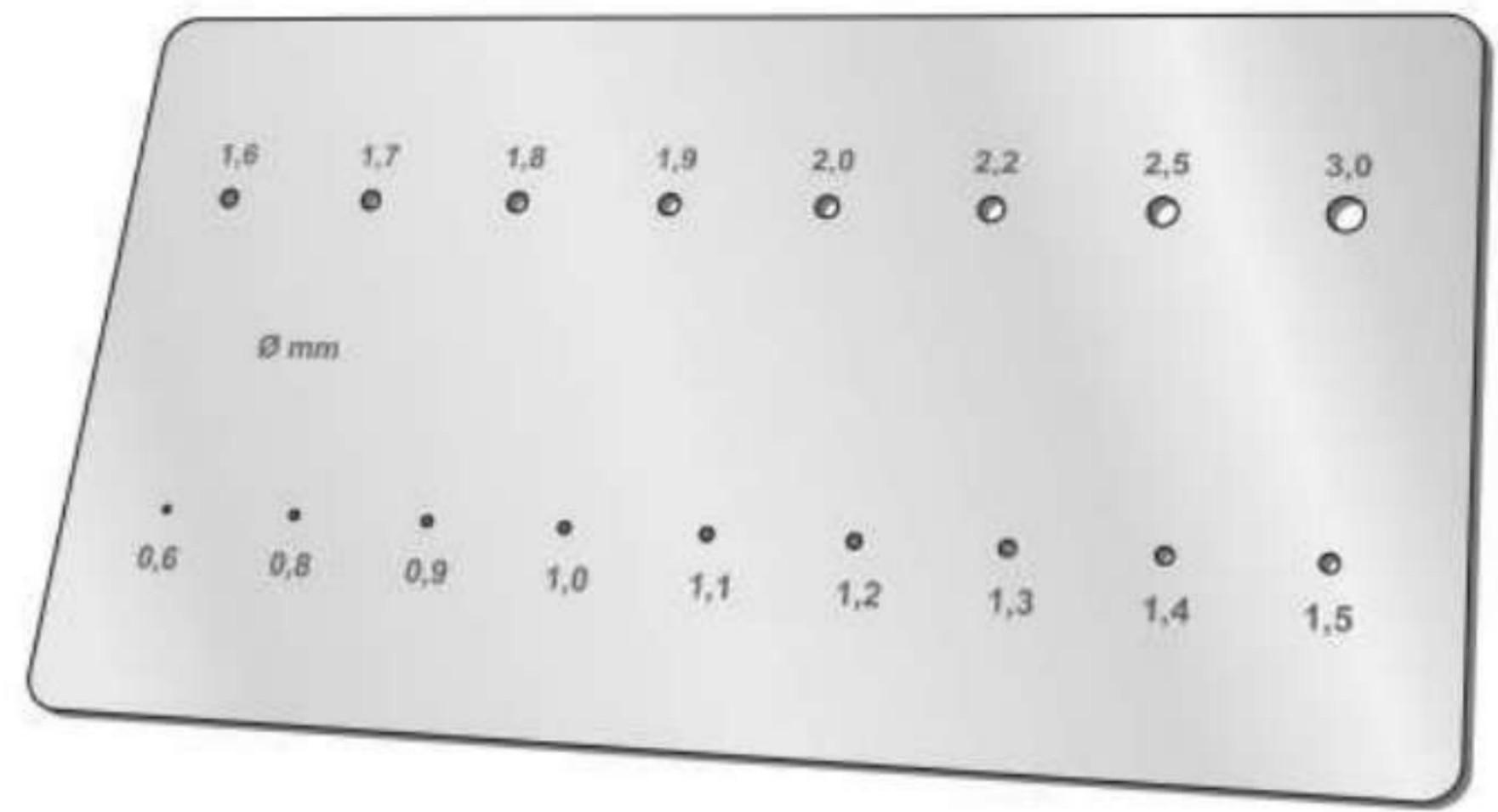

KI-10
Meßlehre für Kirschnerdrähte
Measuring Gauge for K-wire
Misuratore per chiodi Kirschner
Medidor para agujas Kirschner

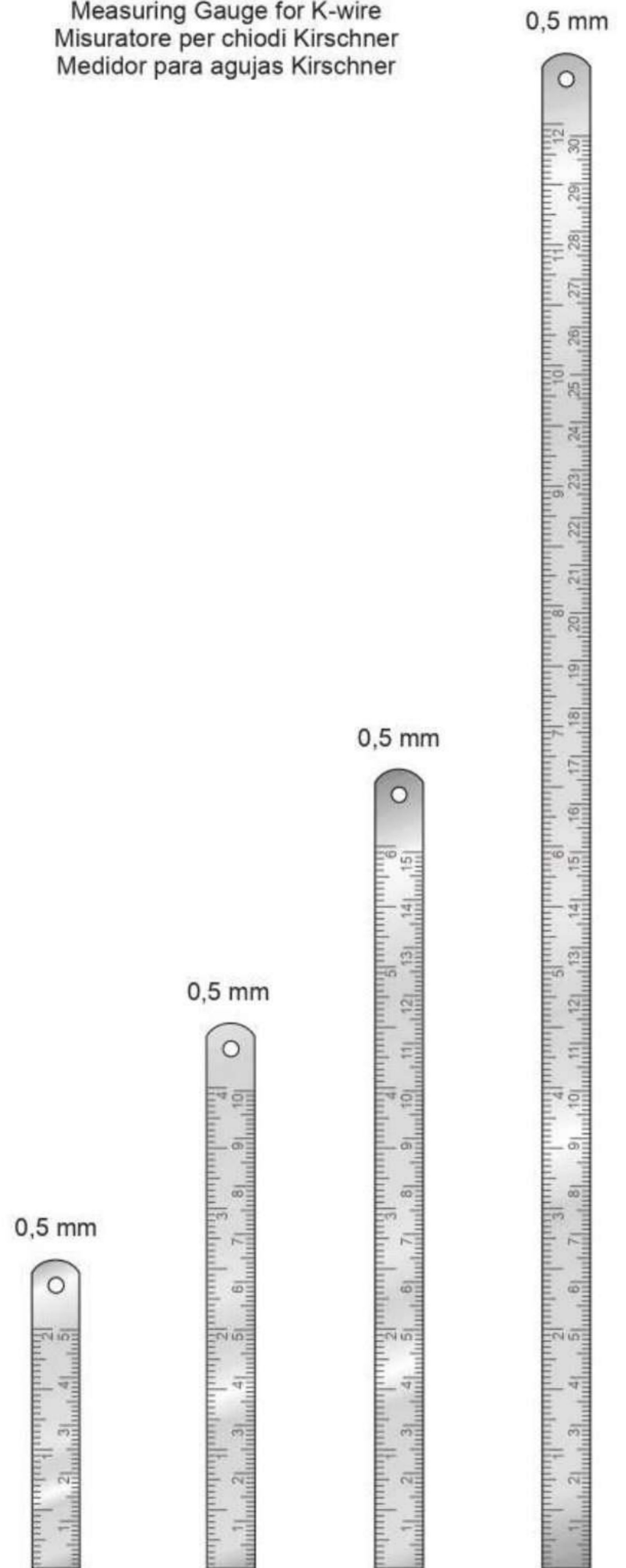
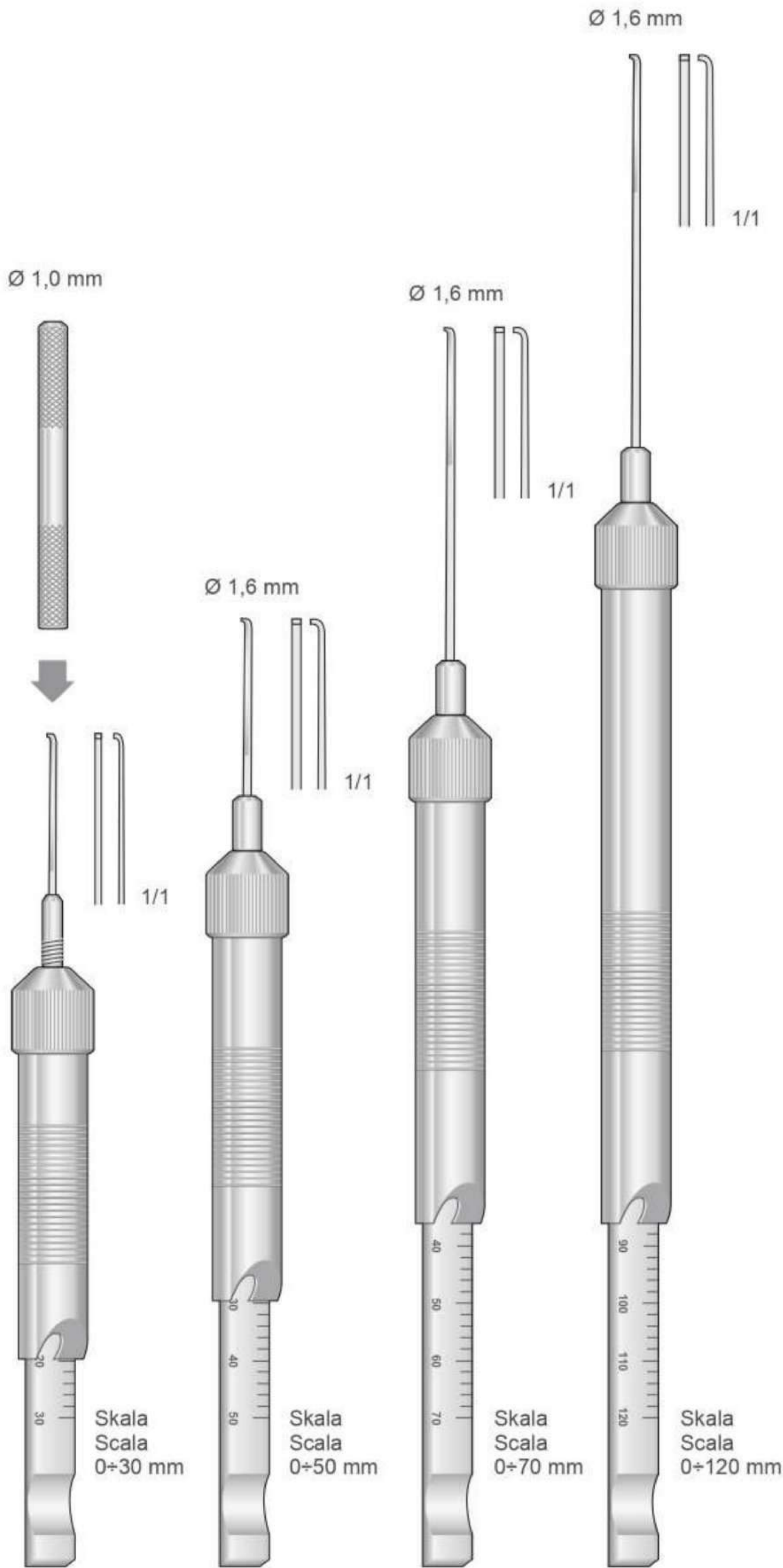

LS-199
138 mm

LS-200
156 mm

LS-201
190 mm

LS-202
285 mm

LS-07
50 mm

LS-08
100 mm

LS-09
150 mm

LS-06
300 mm

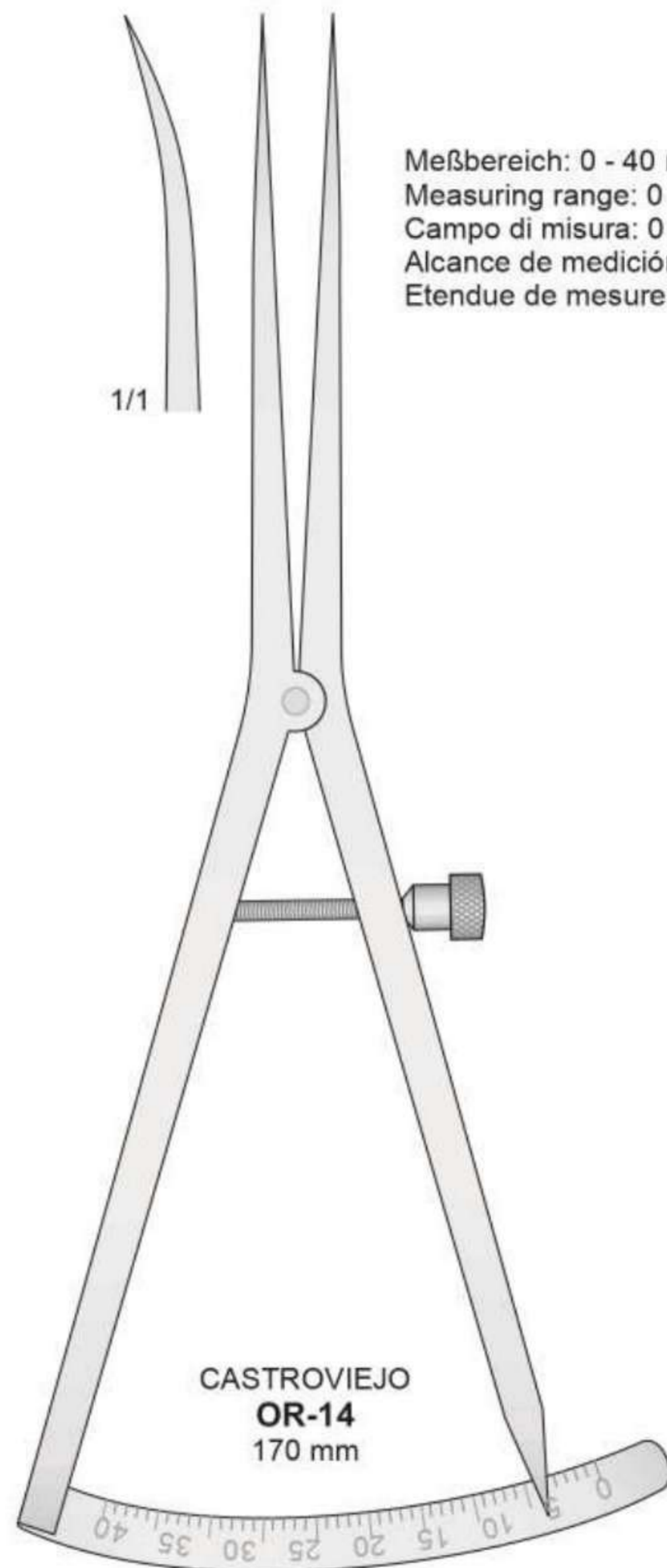
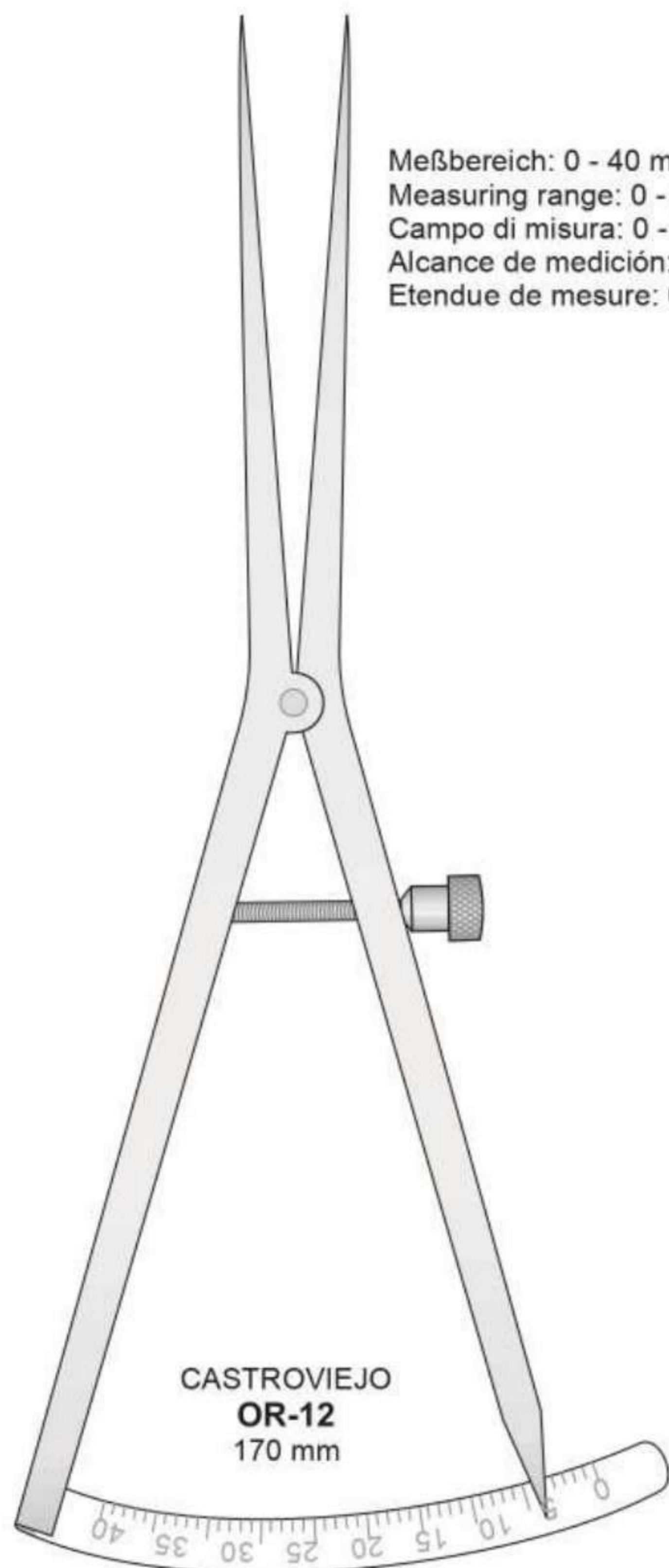

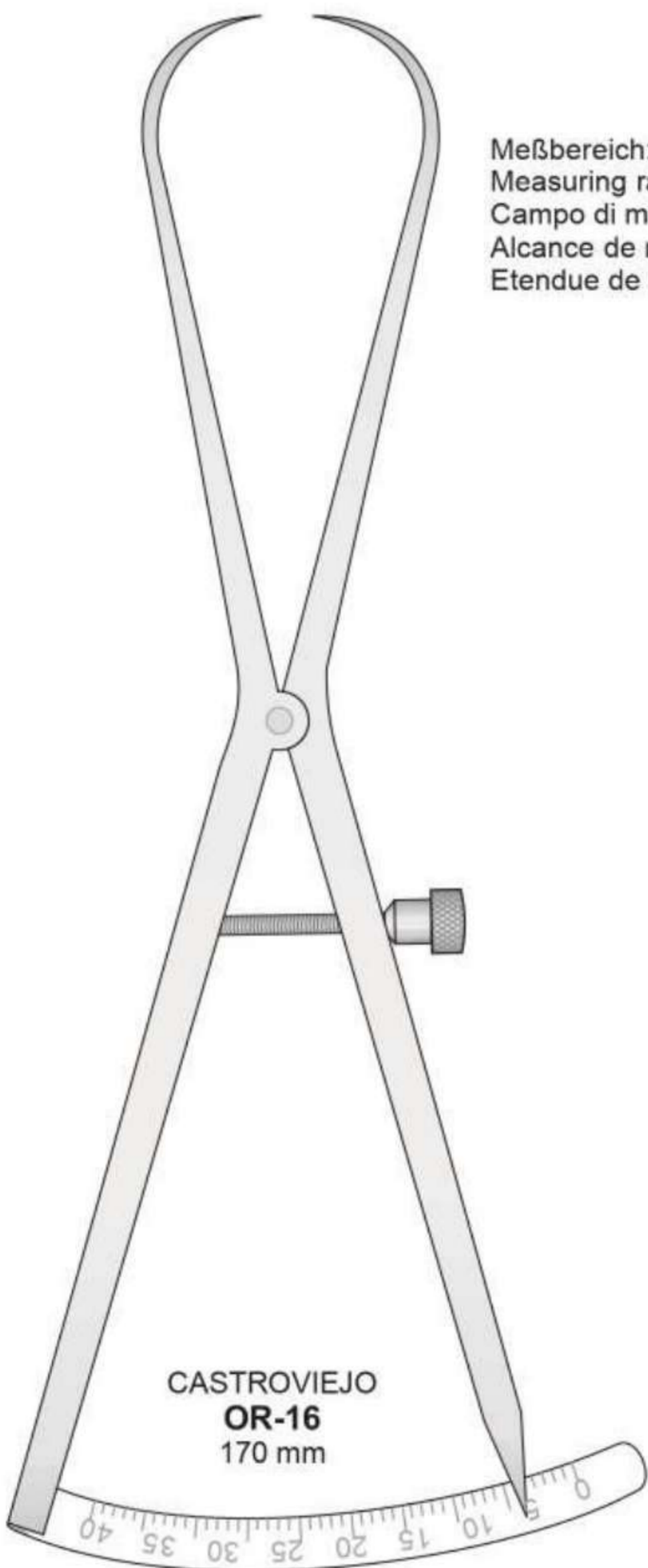

Meßbereich: 0 - 40 mm
Measuring range: 0 - 40 mm
Campo di misura: 0 - 40 mm
Alcance de medición: 0 - 40 mm
Etendue de mesure: 0 - 40 mm

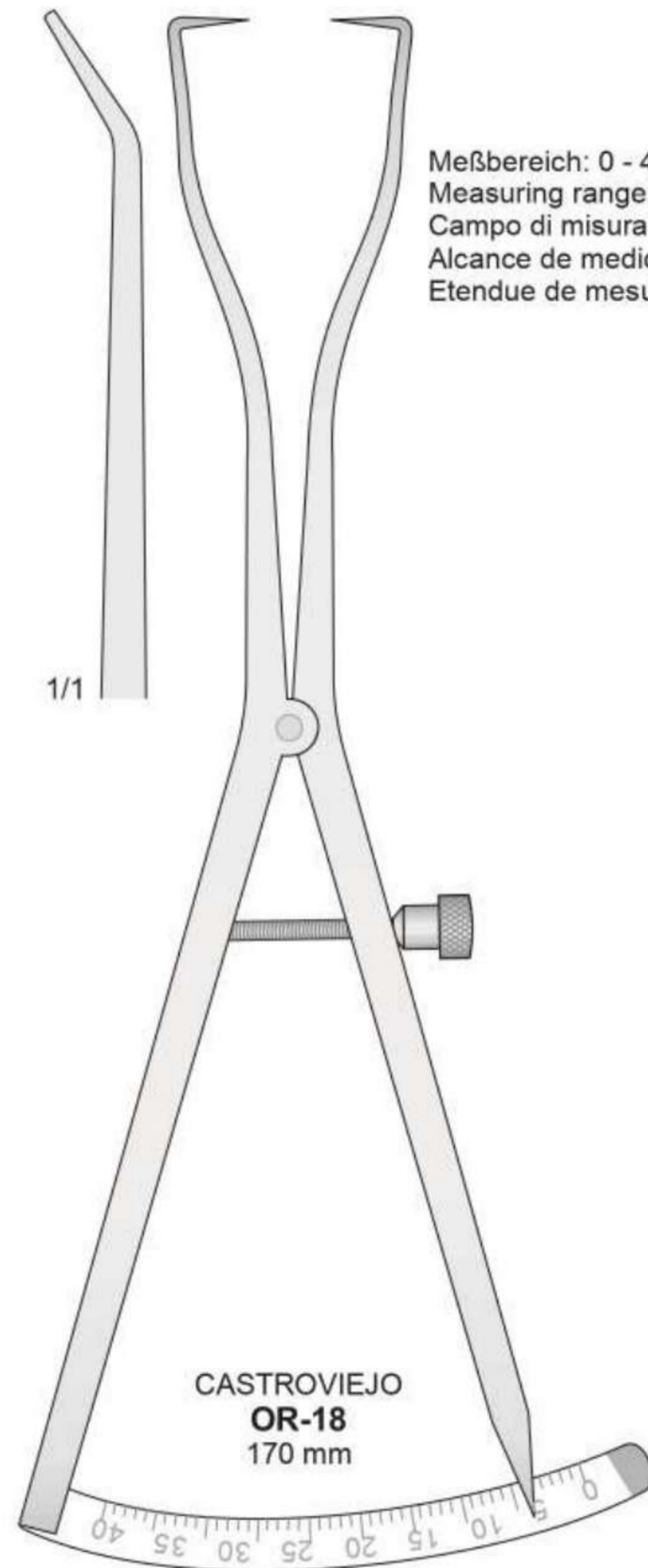

Meßbereich: 0 - 40 mm
Measuring range: 0 - 40 mm
Campo di misura: 0 - 40 mm
Alcance de medición: 0 - 40 mm
Etendue de mesure: 0 - 40 mm

Meßbereich: 0 - 40 mm
 Measuring range: 0 - 40 mm
 Campo di misura: 0 - 40 mm
 Alcance de medición: 0 - 40 mm
 Etendue de mesure: 0 - 40 mm

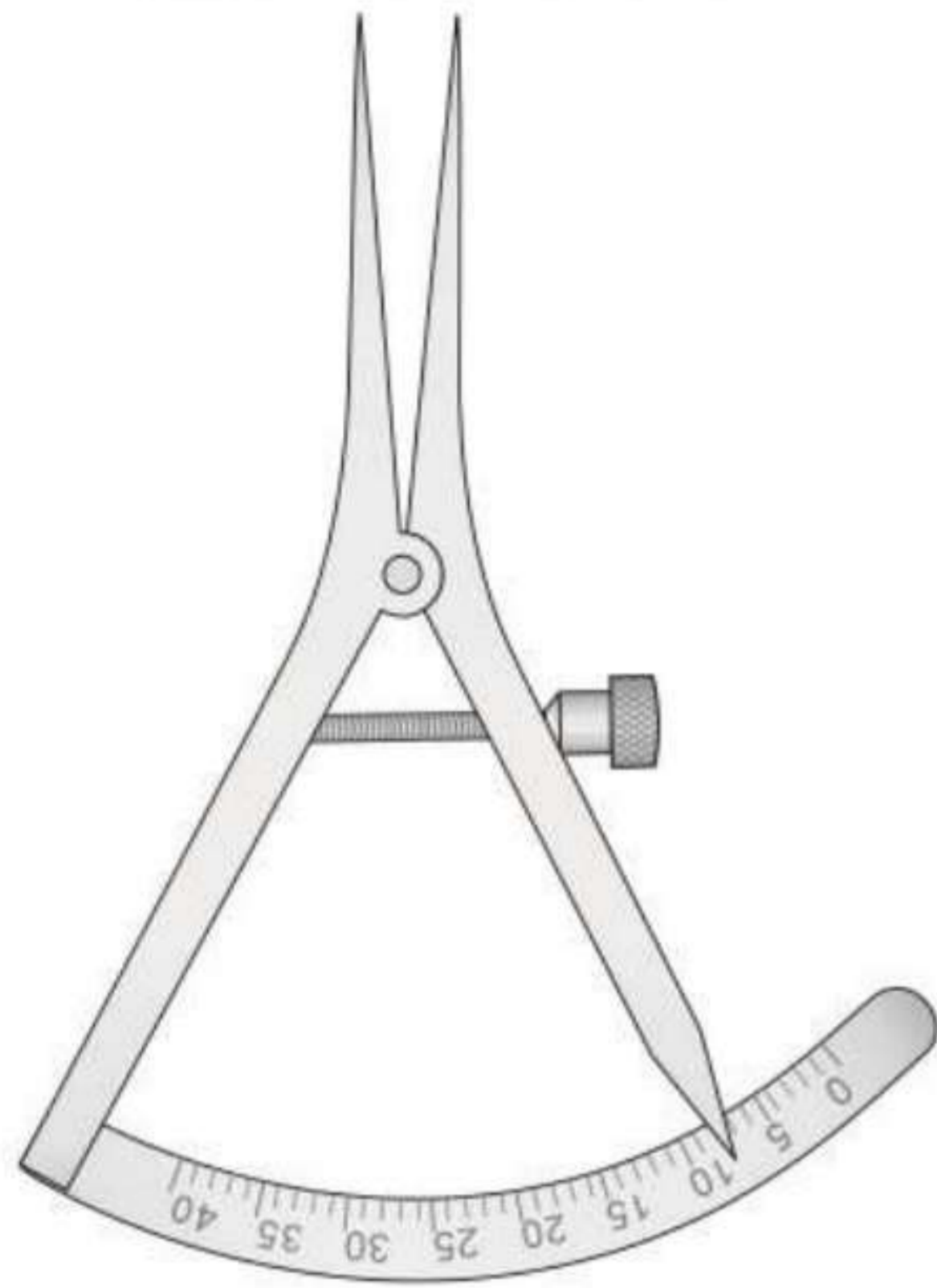

CASTROVIEJO
OR-11
 90 mm

Meßbereich: 0 - 40 mm
 Measuring range: 0 - 40 mm
 Campo di misura: 0 - 40 mm
 Alcance de medición: 0 - 40 mm
 Etendue de mesure: 0 - 40 mm

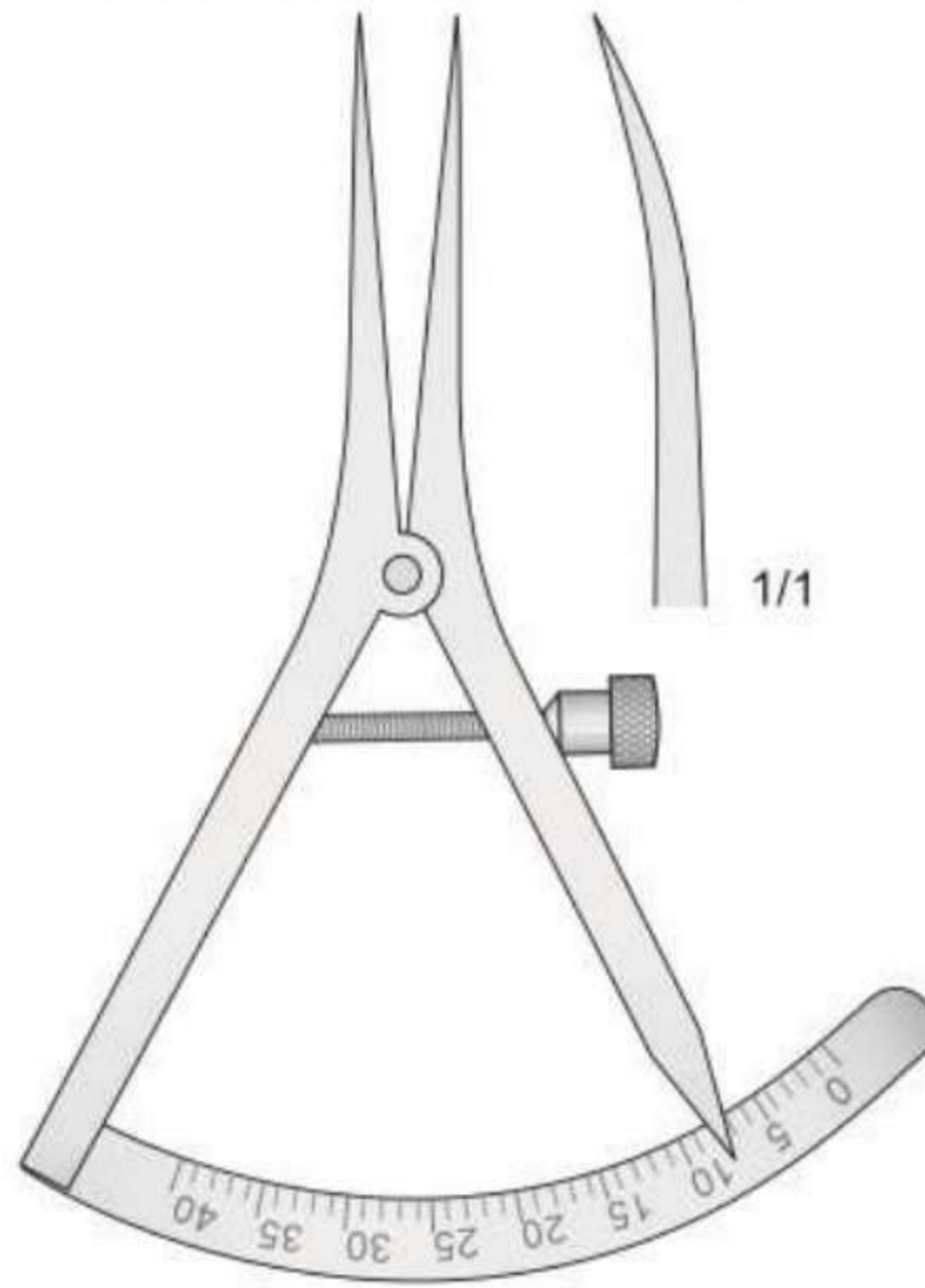

CASTROVIEJO
OR-13
 90 mm

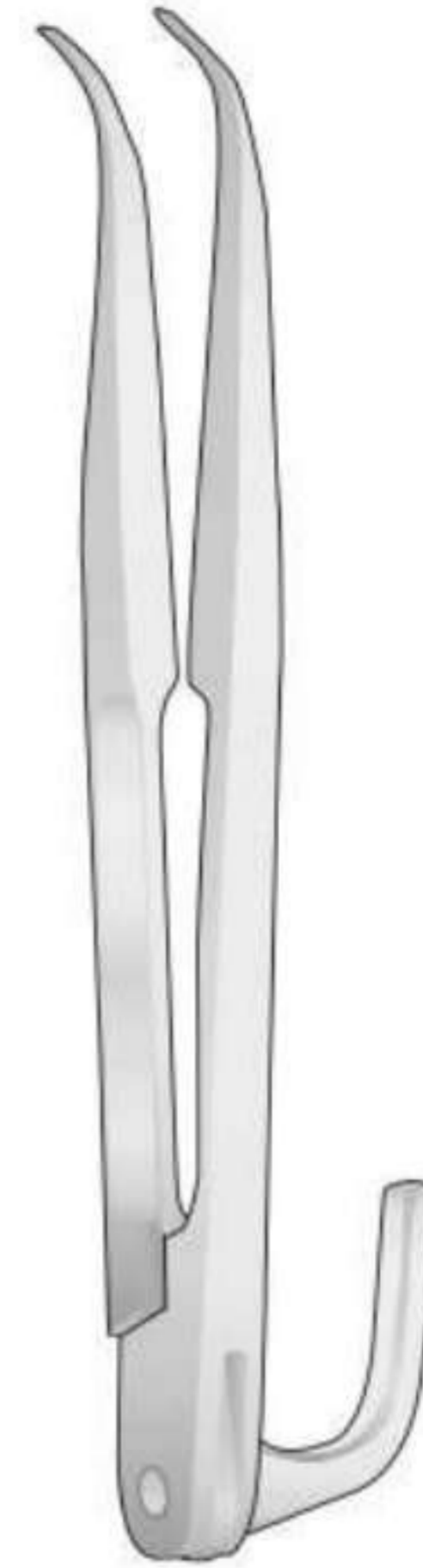

ZIELINSKY
DP-725
 110 mm

Meßbereich: 0 - 15 mm
 Measuring range: 0 - 15 mm
 Campo di misura: 0 - 15 mm
 Alcance de medición: 0 - 15 mm
 Etendue de mesure: 0 - 15 mm

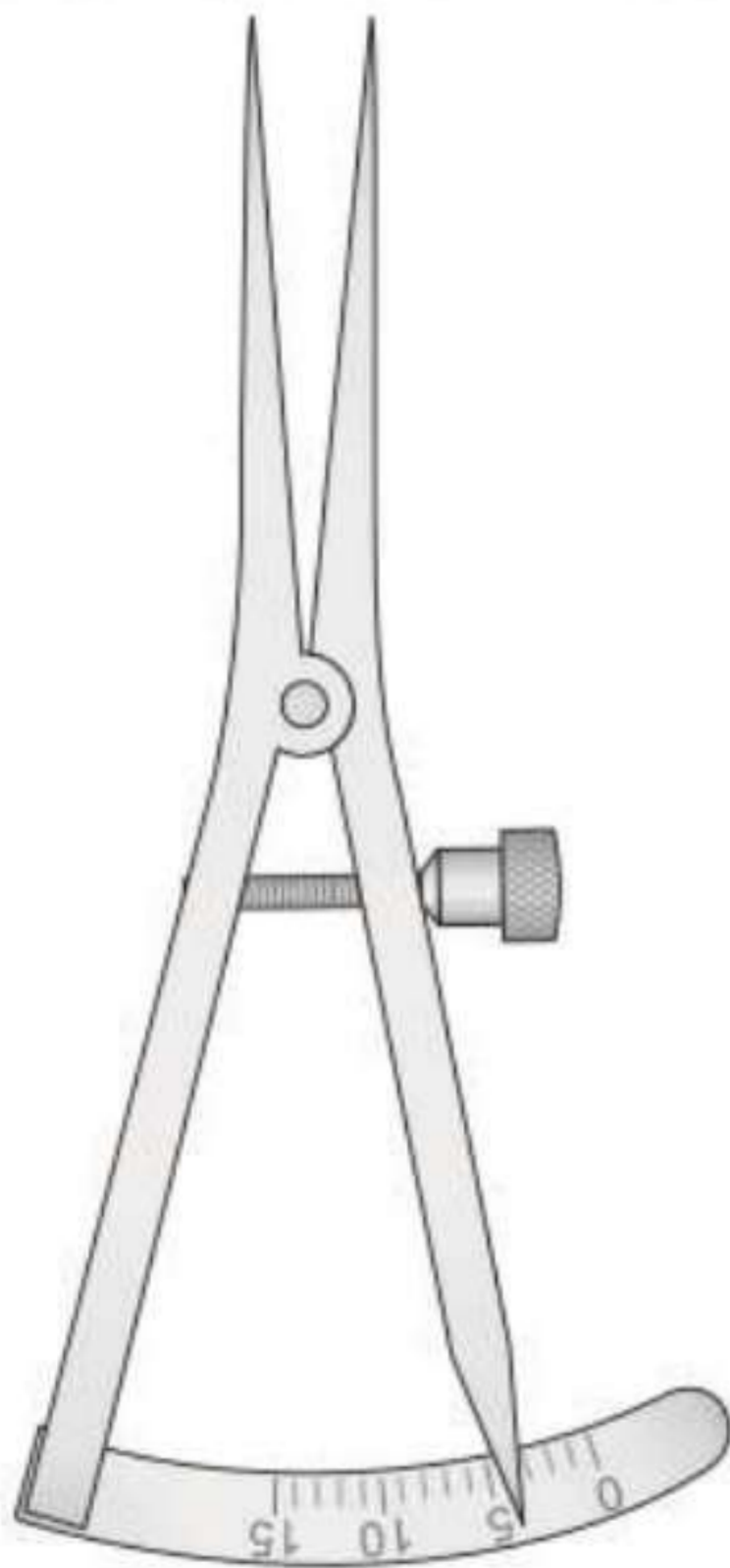

CASTROVIEJO
OR-15
 90 mm

Meßbereich: 0 - 20 mm
 Measuring range: 0 - 20 mm
 Campo di misura: 0 - 20 mm
 Alcance de medición: 0 - 20 mm
 Etendue de mesure: 0 - 20 mm

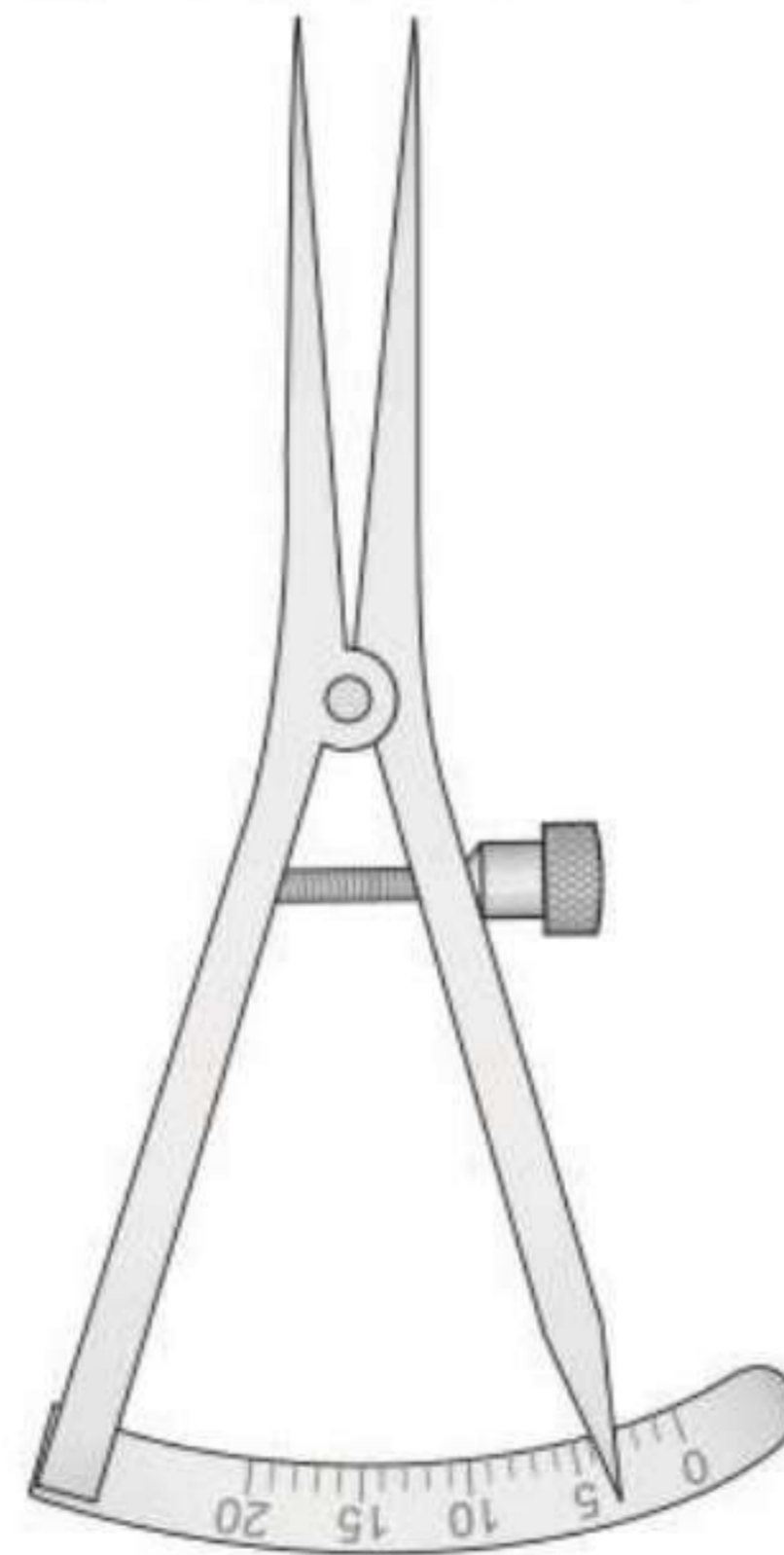

CASTROVIEJO
OR-17
 90 mm

Meßbereich: 0 - 20 mm
 Measuring range: 0 - 20 mm
 Campo di misura: 0 - 20 mm
 Alcance de medición: 0 - 20 mm
 Etendue de mesure: 0 - 20 mm

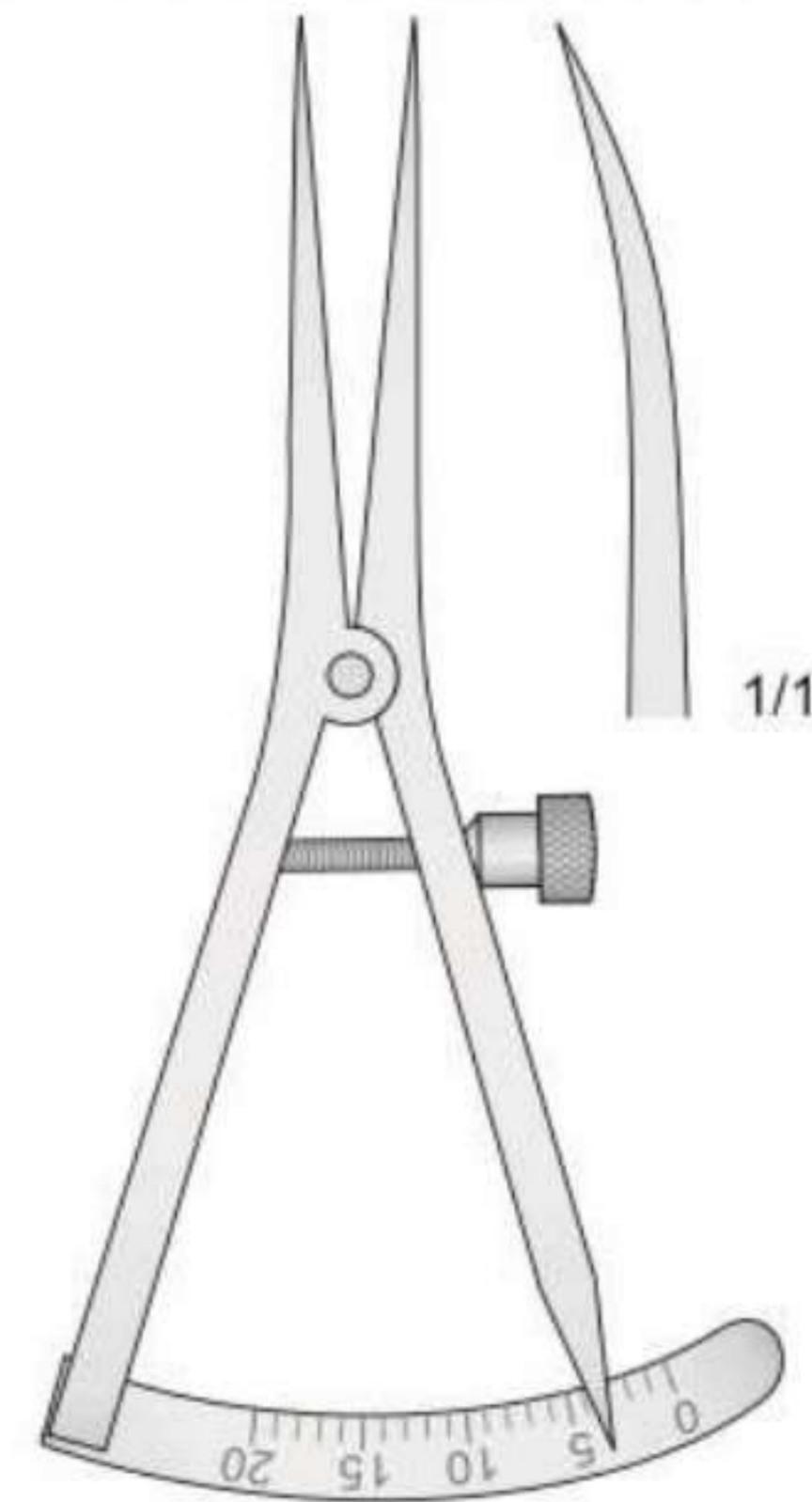

CASTROVIEJO
OR-19
 90 mm



TRS INSTRUMENTS

TRAUMATOLOGY AND ORTHOPAEDICS

Forceps for plattes

Biege und schränkhebel
Pinces à courber pour plaques
Pinzas para placas
Pinze e chiavi per placche

Wire Guides

Drahtumführungsnadel
Aiguilles passe-fils
Agujas pasa hilos
Passafili

Needle Holders

Nadelhalter
Porte-aiguilles
Porta-agujas
Port'aghi

Cutting Pliers

Schneidezangen
Pinces coupante
Alicates de corte
Tronchesi di taglio

Forceps
for plattes

Zangen für
schränkhebel platten

Pinze
per placche

Pinzas
para placas

Pinces à courber
pour plaques

Biegezange - Bending pliers - Pinze piegaplacche - Pincas à plier



LS-405
200 mm



LS-406
240 mm

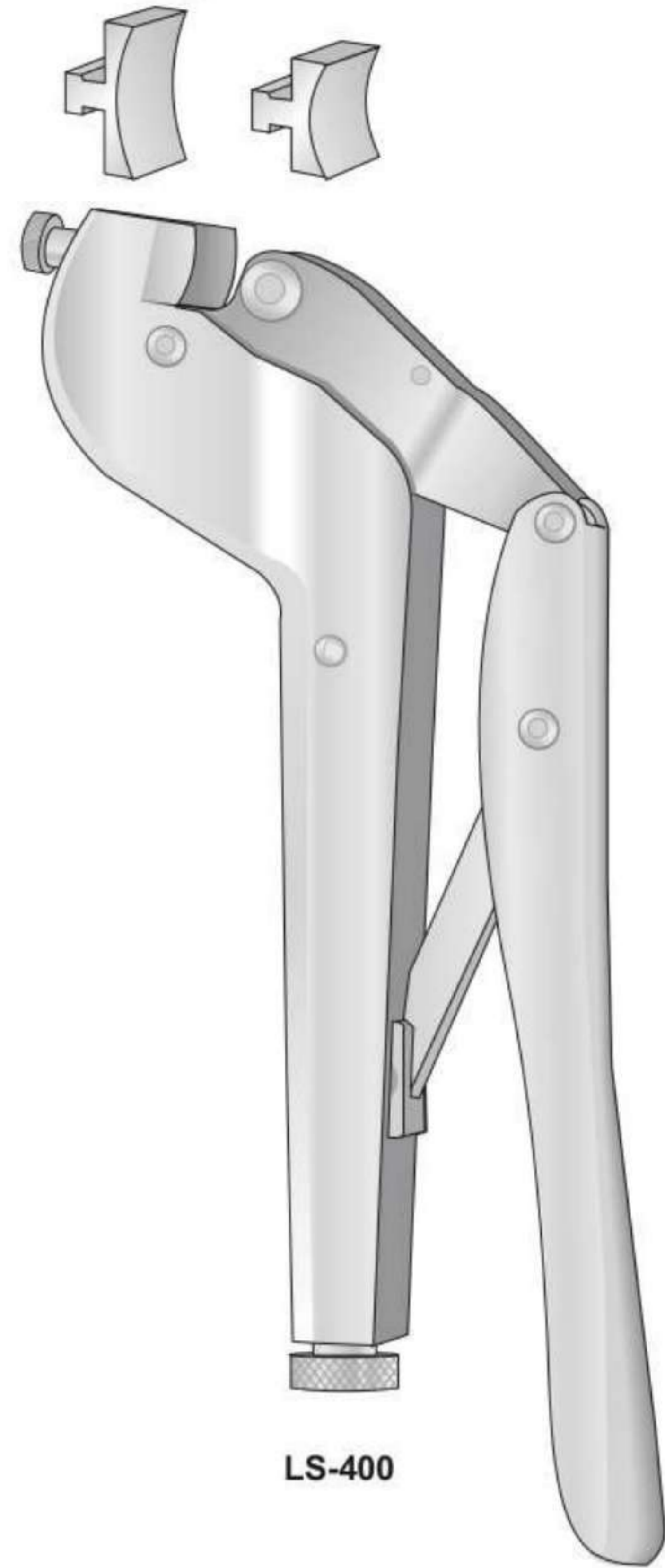

LS-400

Biegepresse - Bending press - Pressa piegaplacche - Presse pour plier

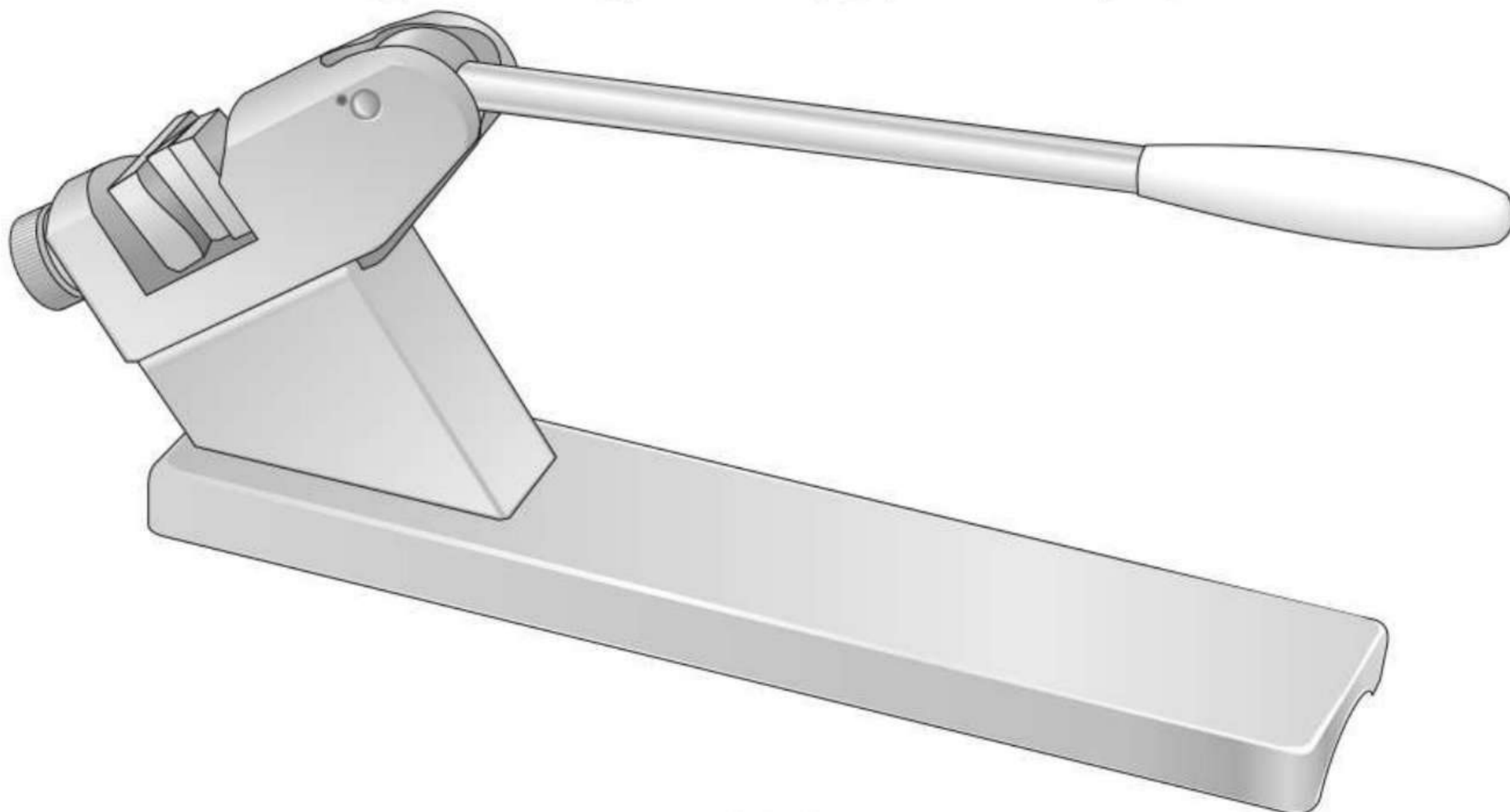

LS-410

Forceps
for plattes

Zangen für
schränkhebel platten

Pinze
per placche

Pinzas
para placas

Pinces à courber
pour plaques

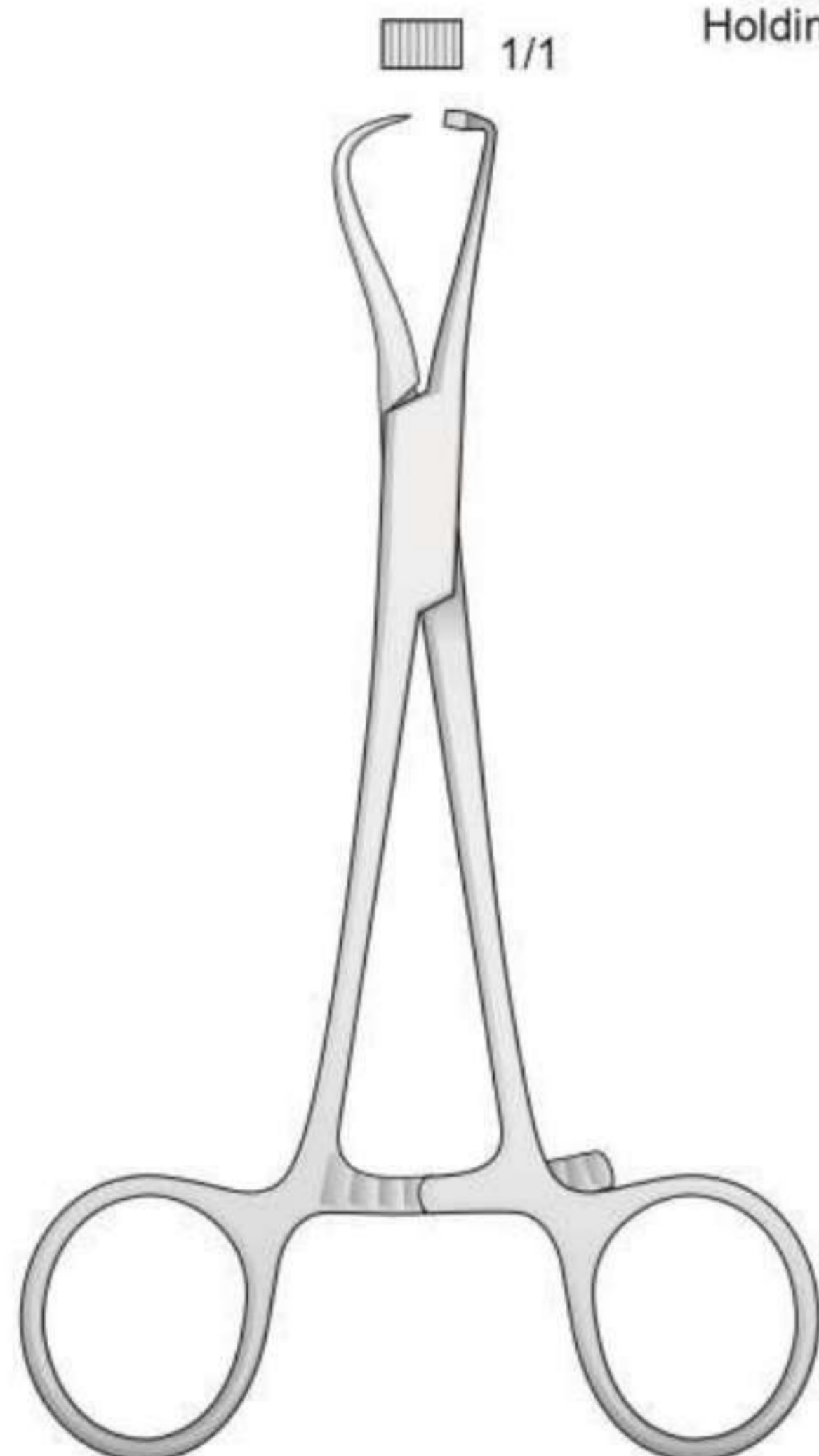

LS-76
120 mm

Haltezange für platten
Holding forceps for plates

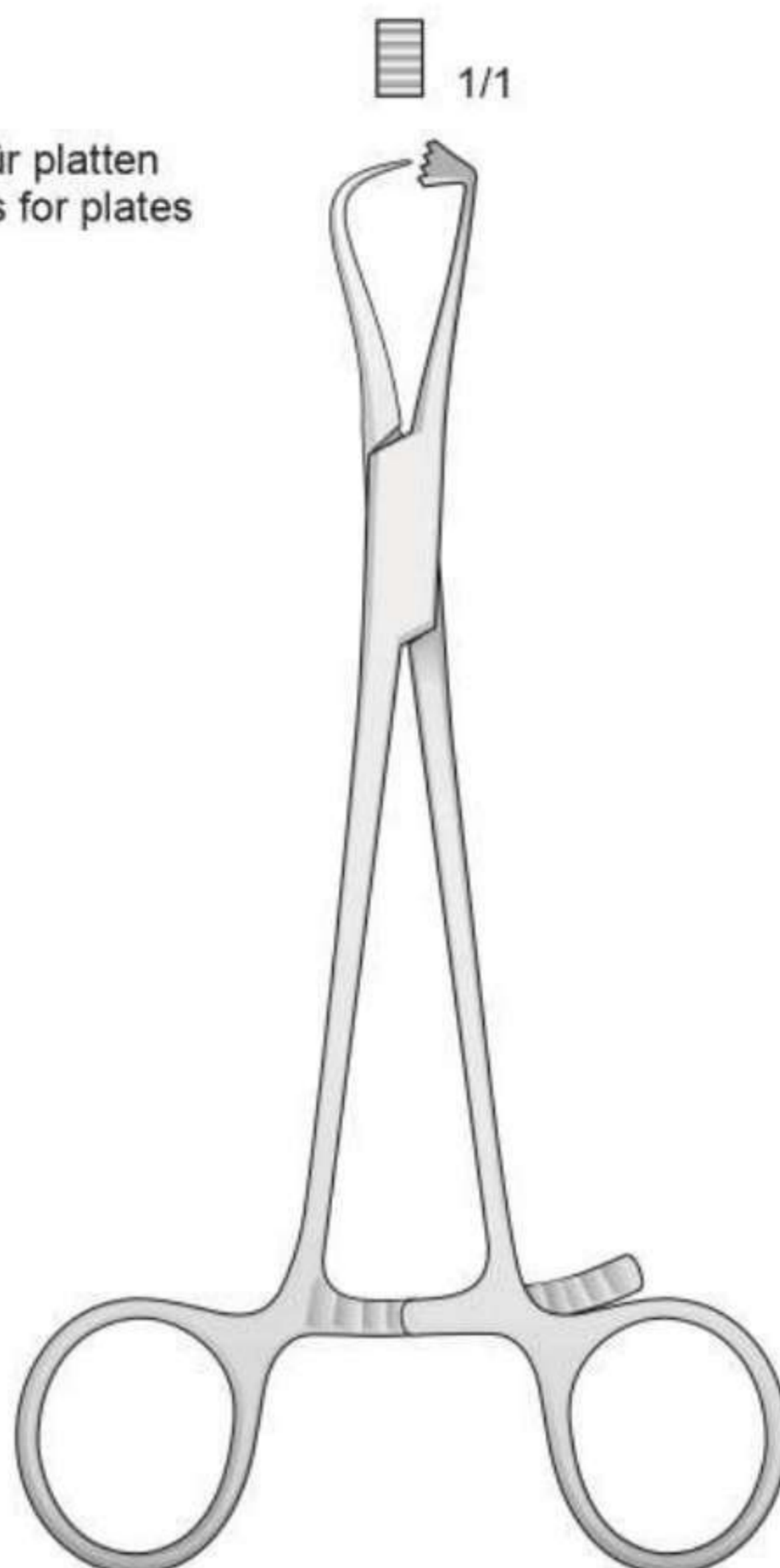

LS-78
125 mm

For standard plates
Für Standard-Platten

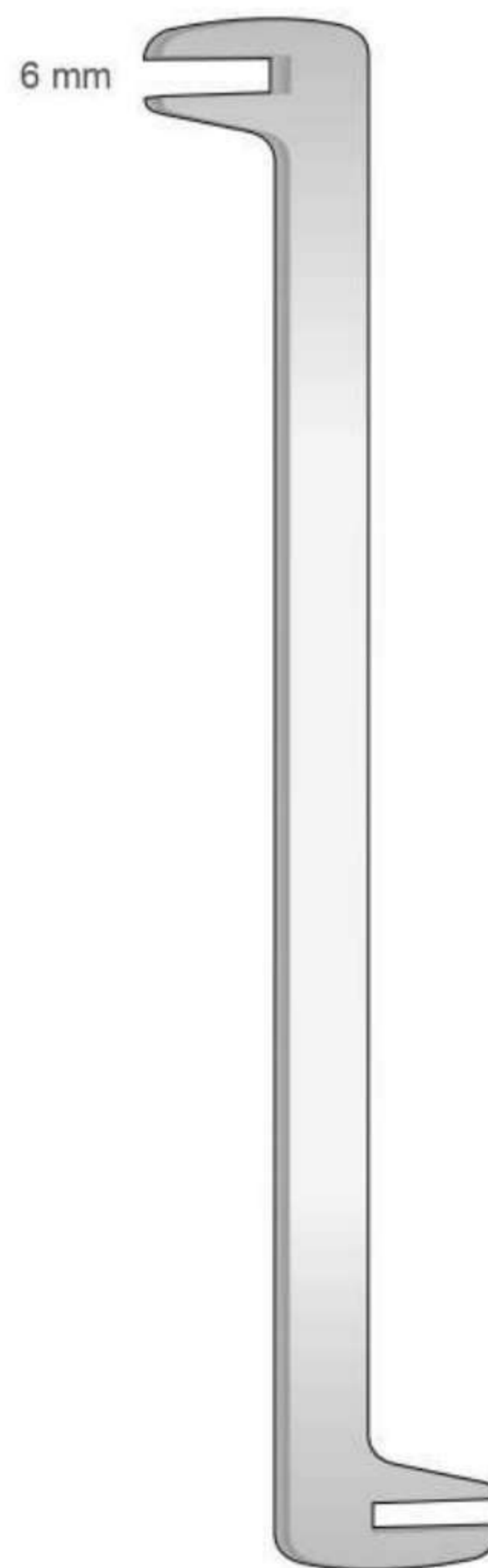

LS-105
250 mm

Für Standard-Platten
For standard plates

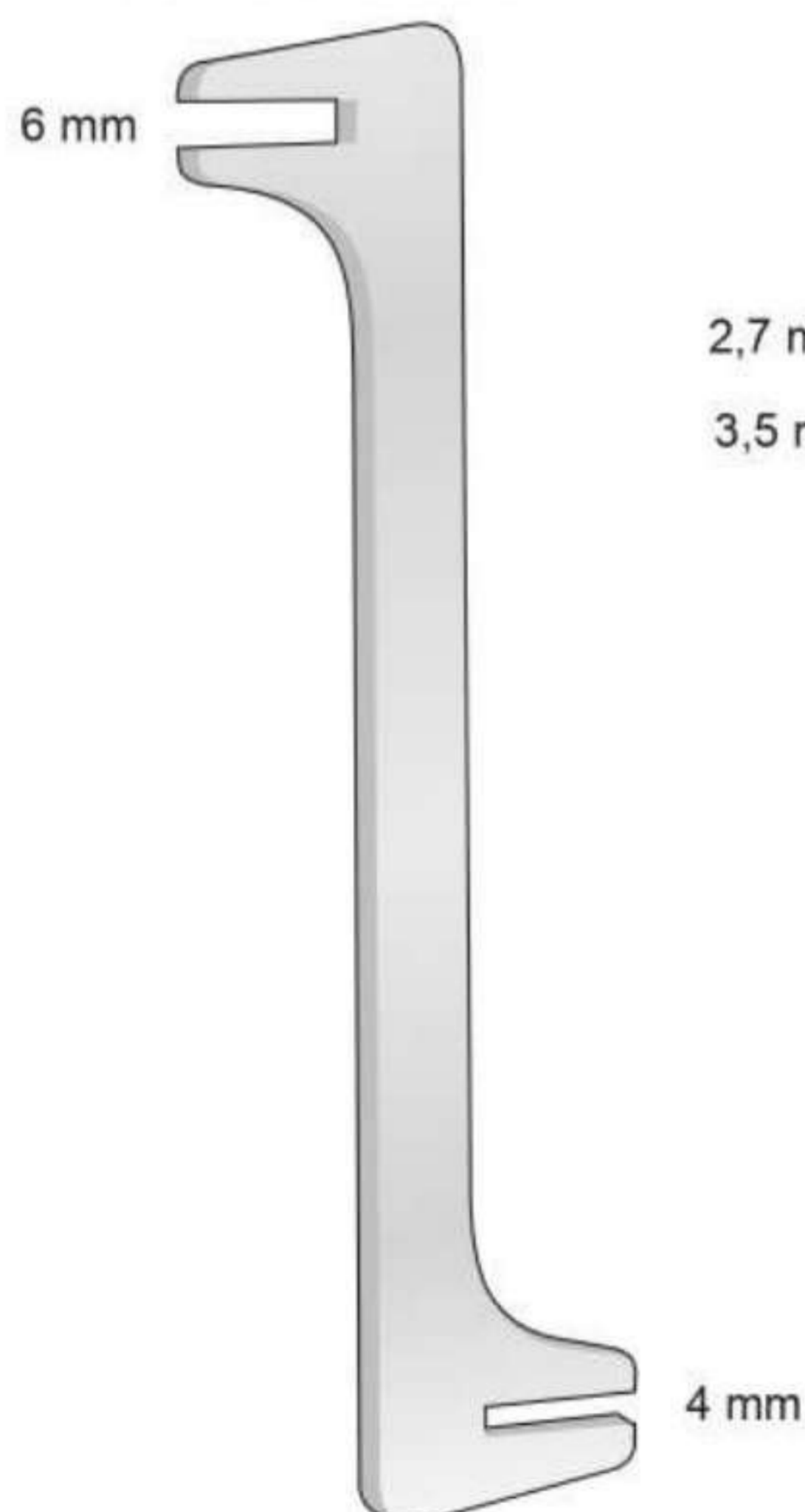

LS-101
180 mm

Biege und Schränkhebel für kleine platten
Bending irons, for small plates

Per placche da
2,7 mm e 3,5 mm



LS-103 100 mm
LS-102 140 mm



LS-123 100 mm
LS-122 140 mm



LS-104
100 mm

Drahtumföhrungsnadel

Wire guides

Passafili

Agujas pasa hilos

Aiguilles passe-fils



DEMEL
BM-12/BM-14



BM-12
275 mm

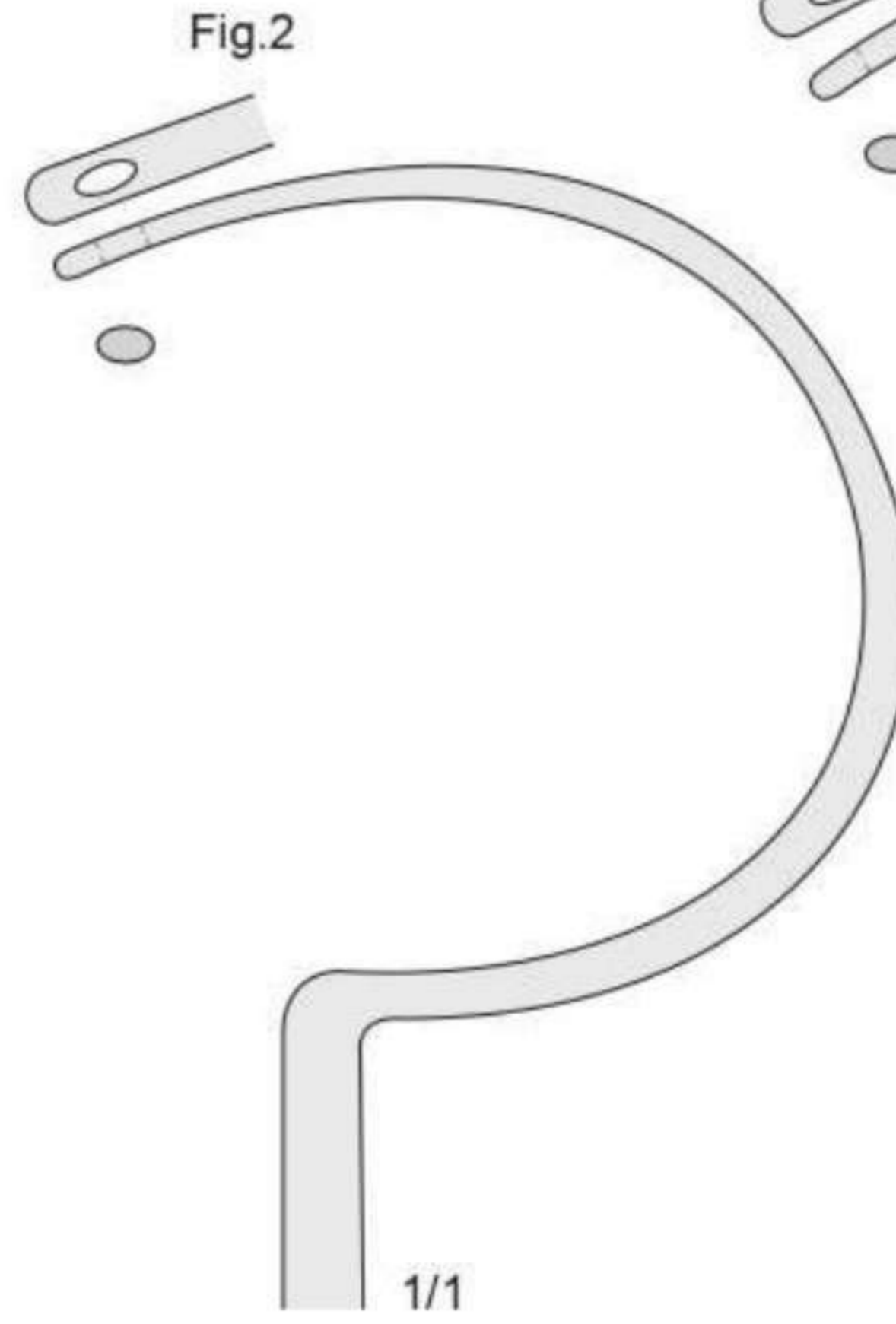

BM-13
285 mm

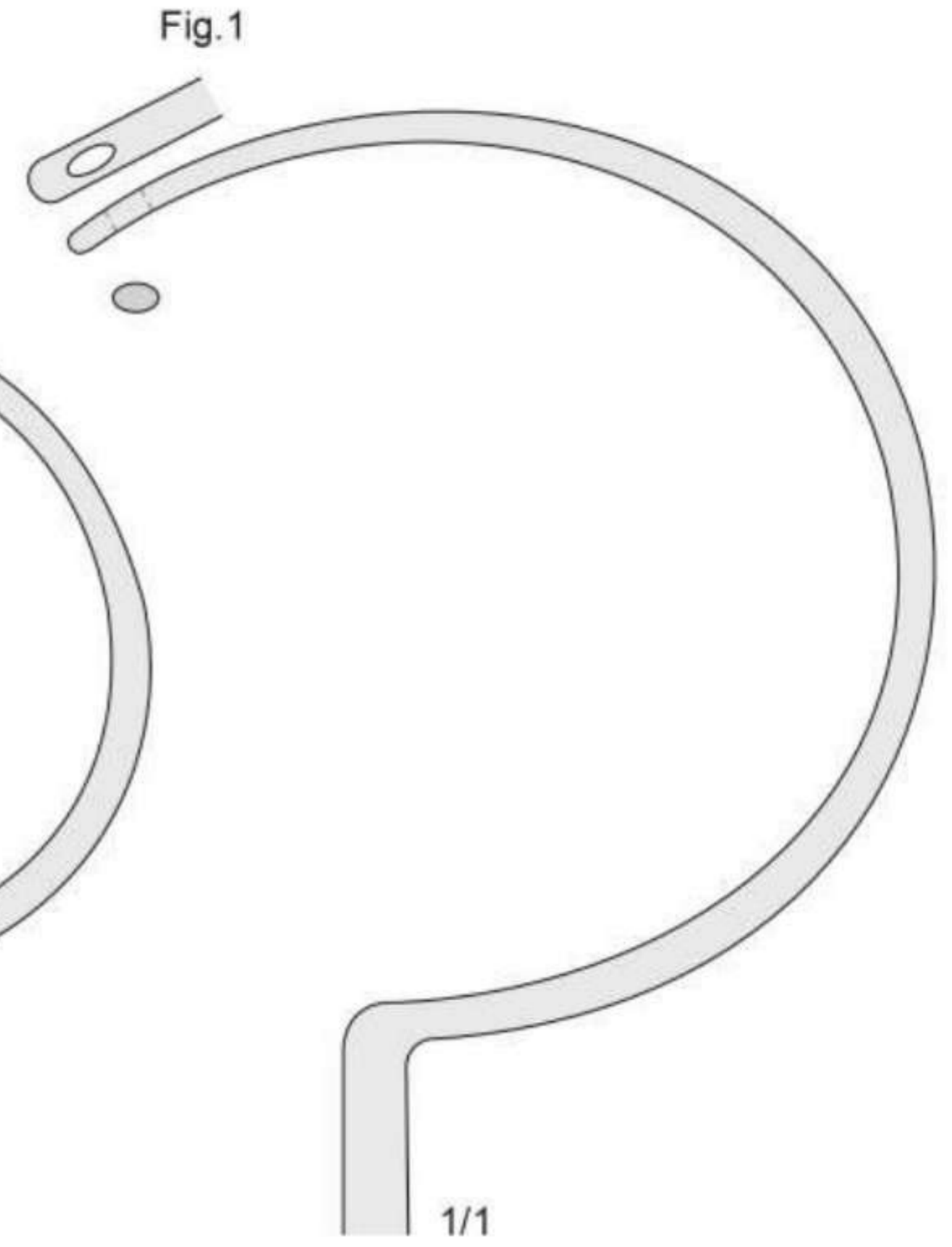

BM-14
295 mm

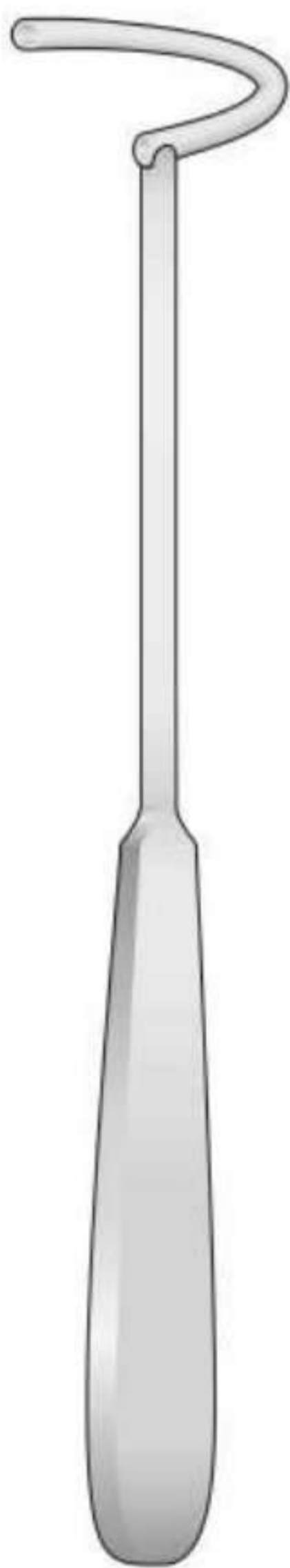

BM-10
225 mm

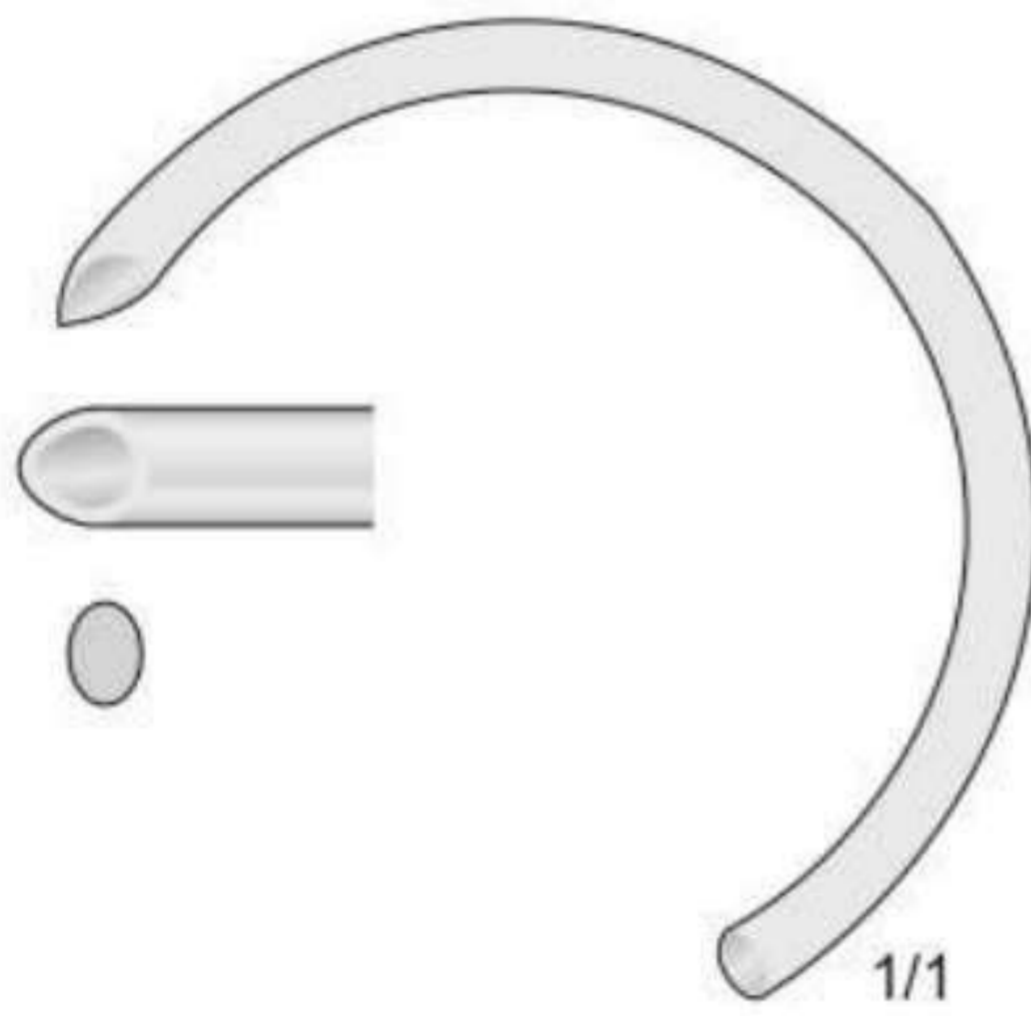

BM-10
225 mm

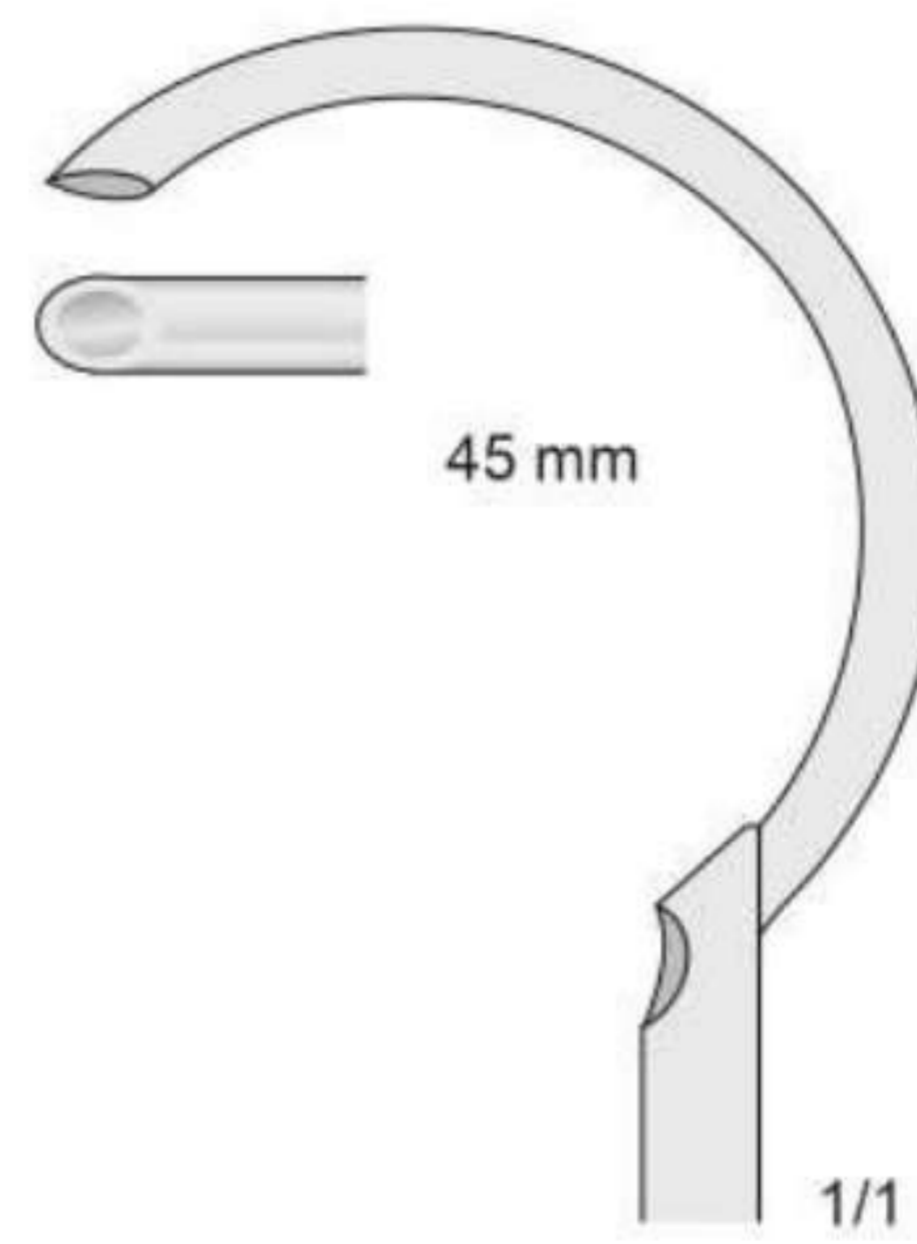

BM-11
240 mm

45 mm

1/1

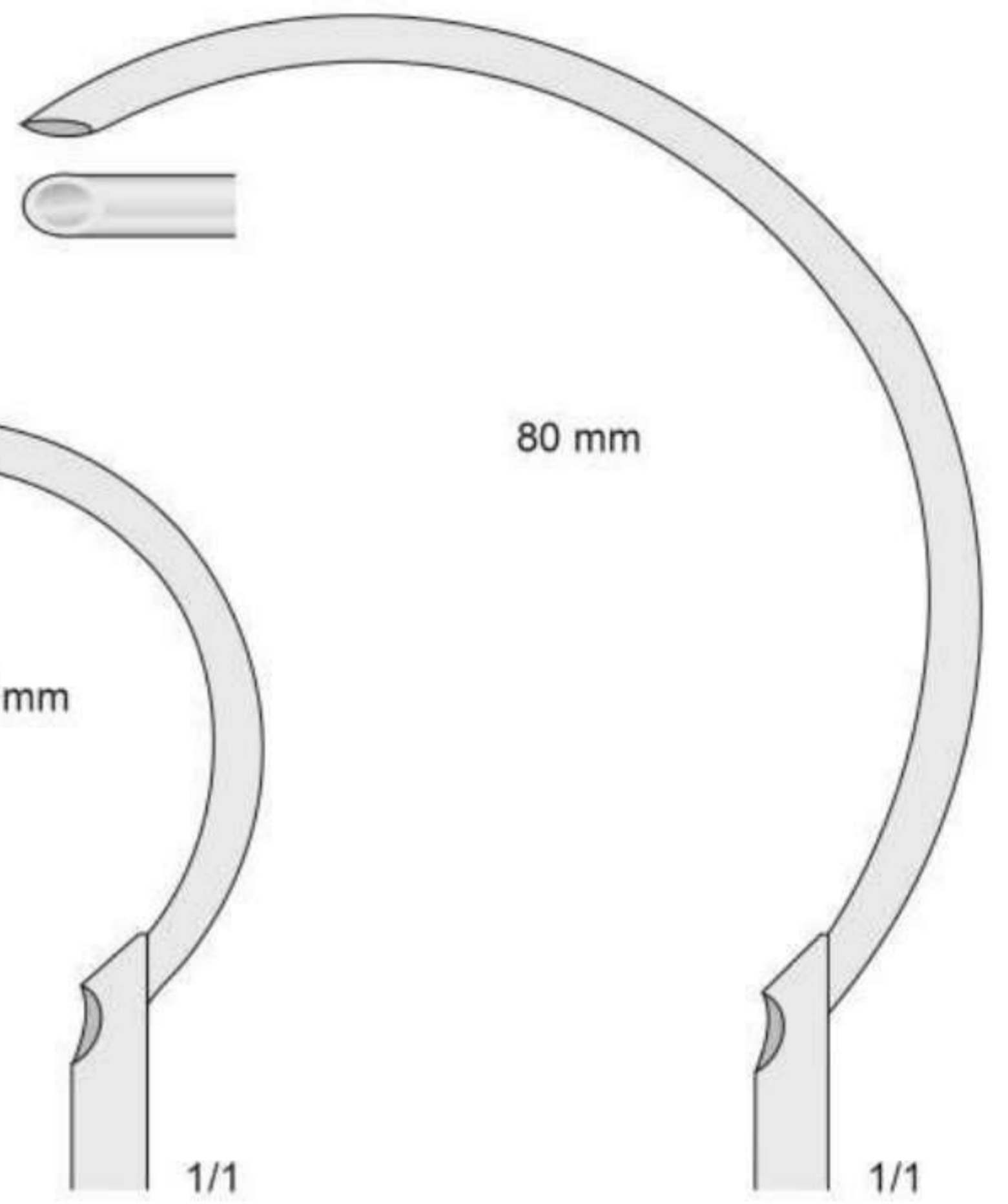

BM-09
270 mm

80 mm

1/1

Drahtumföhrungsnadel

Wire guides

Passafili

Agujas pasa hilos

Aiguilles passe-fils

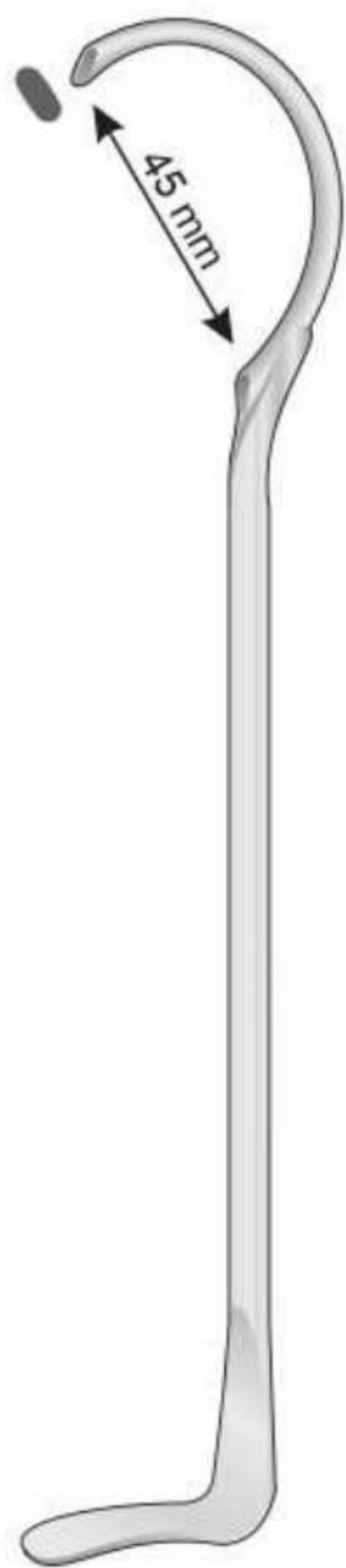

BM-50
185 mm

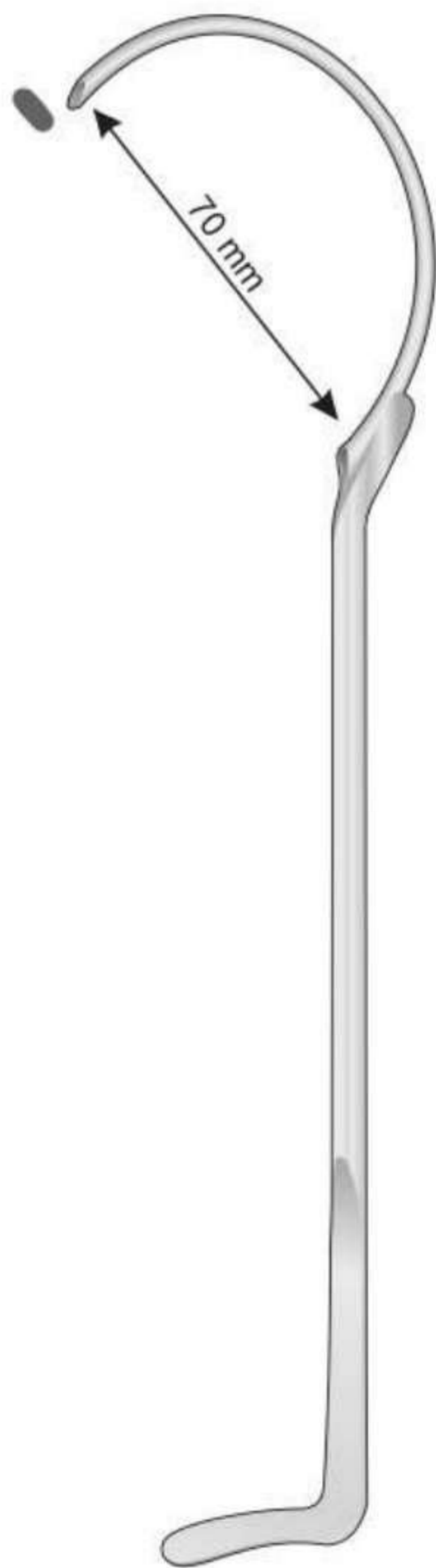

BM-51
235 mm

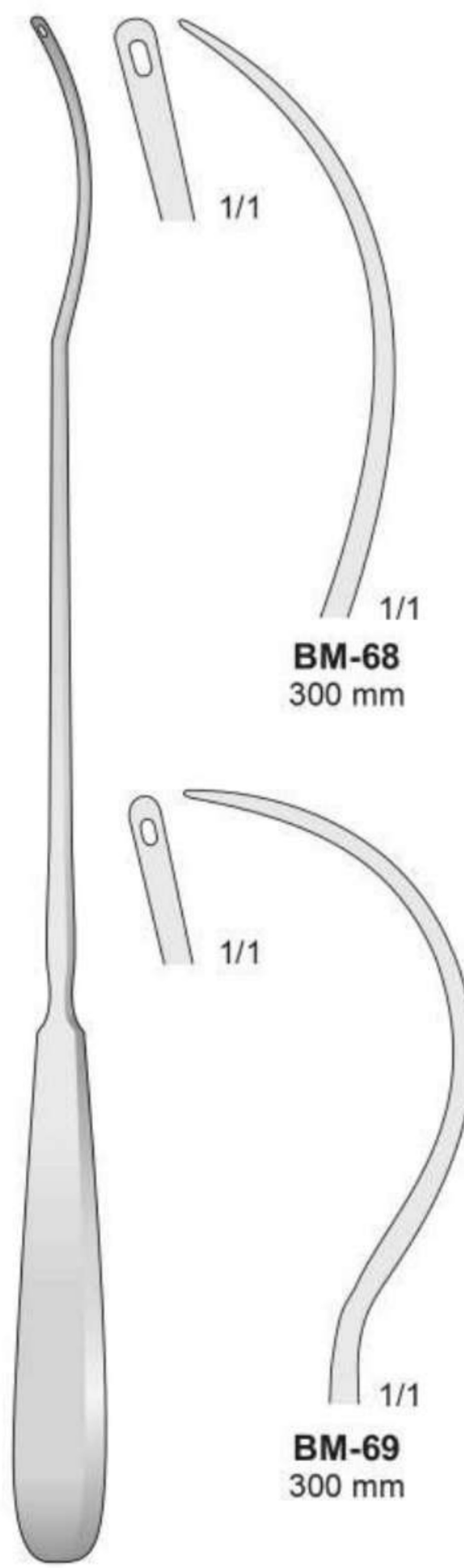

BRUNNER
BM-68/BM-69
300 mm

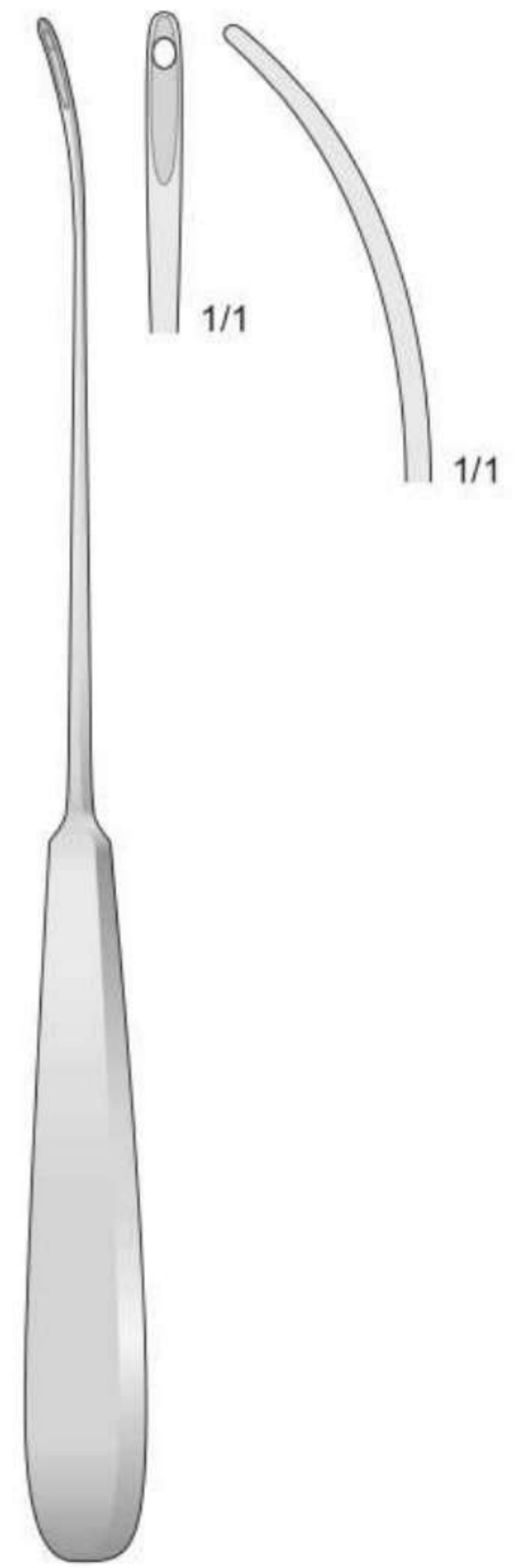

BM-74
230 mm

Unterbindungsnadeln

Ligature needles

Aghi per legature

Agujas para ligaduras

Aiguilles à ligatures

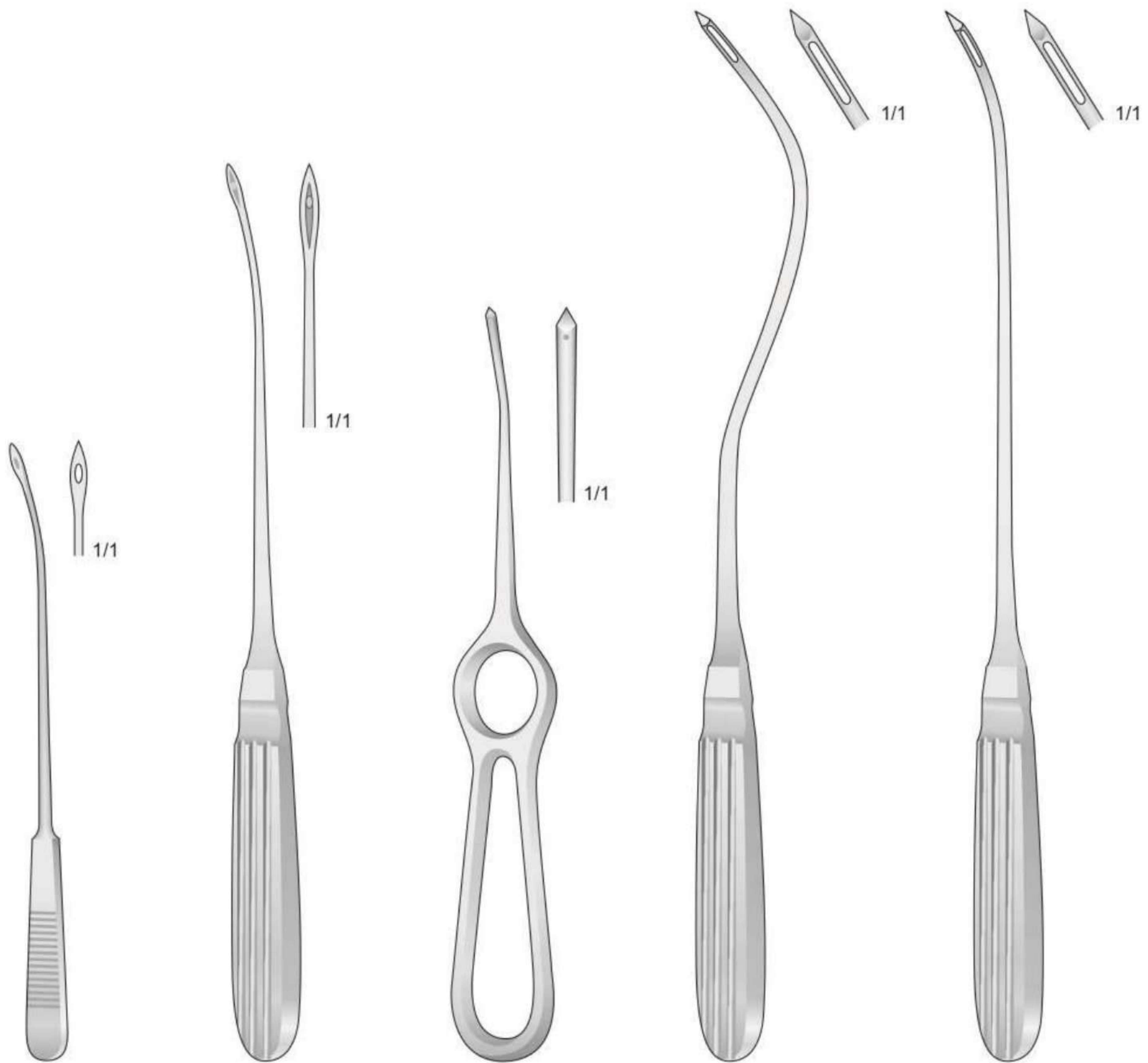

OBWEGESER
DO-30
140 mm

OBWEGESER
DO-31
230 mm

DO-32
180 mm

SANDERS-BROWN
DO-44
290 mm

SANDERS-BROWN
DO-49
300 mm

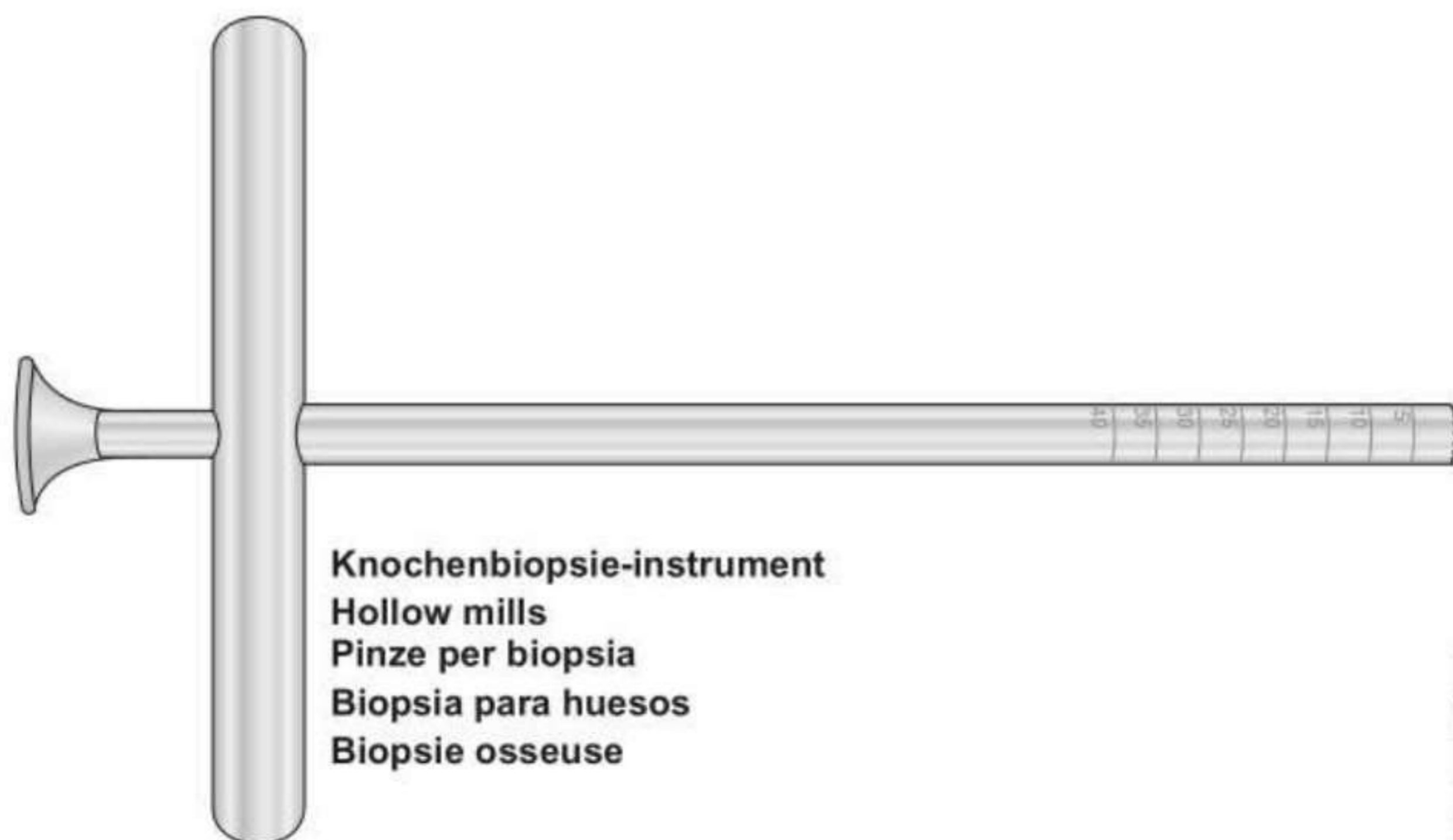

Knochenbiopsie-instrument
Hollow mills
Pinze per biopsia
Biopsia para huesos
Biopsie osseuse



FK-92
170 mm

Innen Außen
Inside Outside
Interno Esterno
Interior Exterior
Intérieur Extérieur
Ø 3 mm Ø 4 mm



FK-90
170 mm

Innen Außen
Inside Outside
Interno Esterno
Interior Exterior
Intérieur Extérieur
Ø 3,9 mm Ø 5 mm



FK-91
170 mm

Innen Außen
Inside Outside
Interno Esterno
Interior Exterior
Intérieur Extérieur
Ø 6,4 mm Ø 8 mm

Extraktionszangen
für Bohrdrähte

Extraction pliers
for wire

Pinze d'estrazione
per fili metallici

Pinzas de extracción
para hilo metálico

Pinces pour l'extraction
pour fil métallique

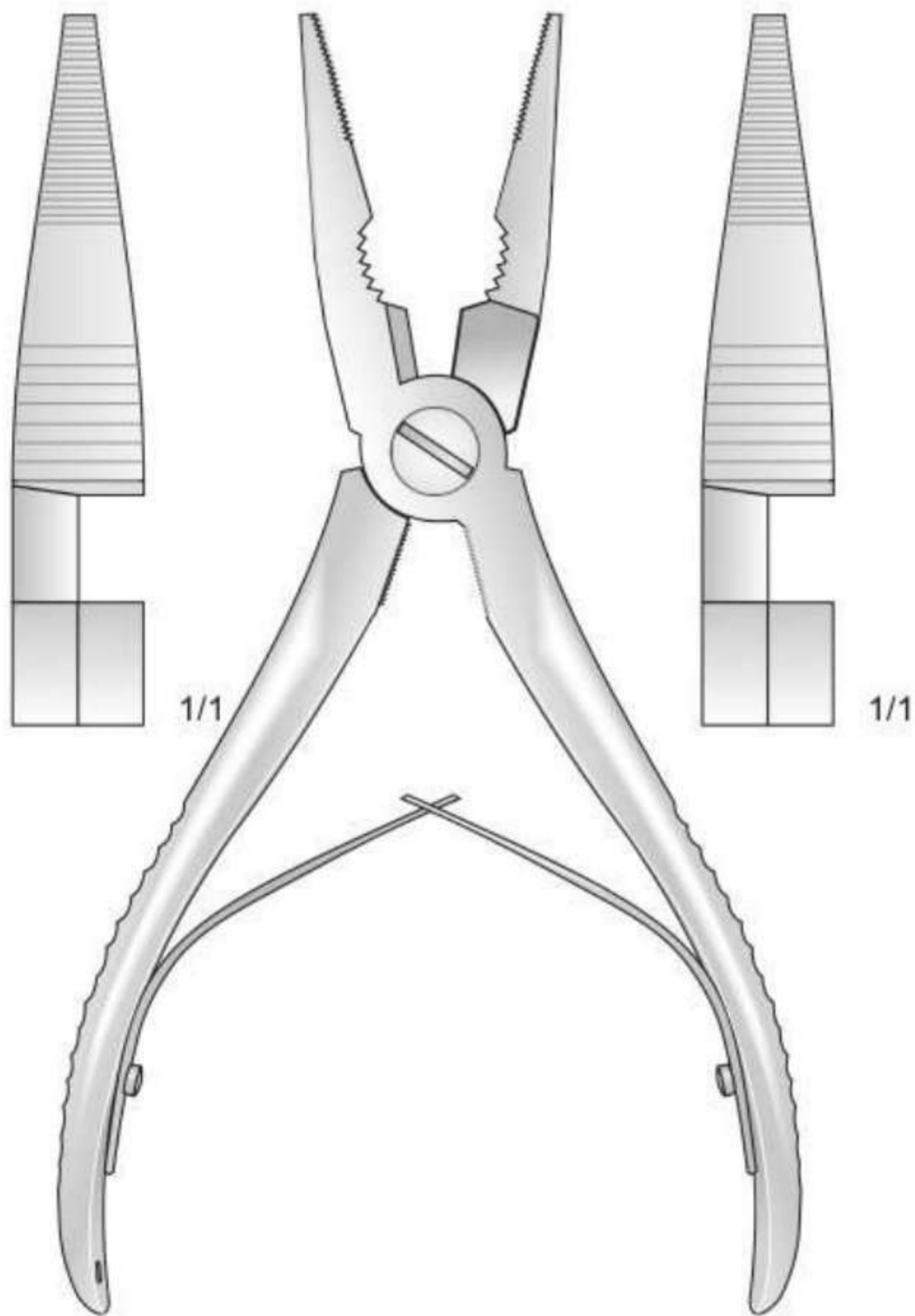

LX-135
175 mm

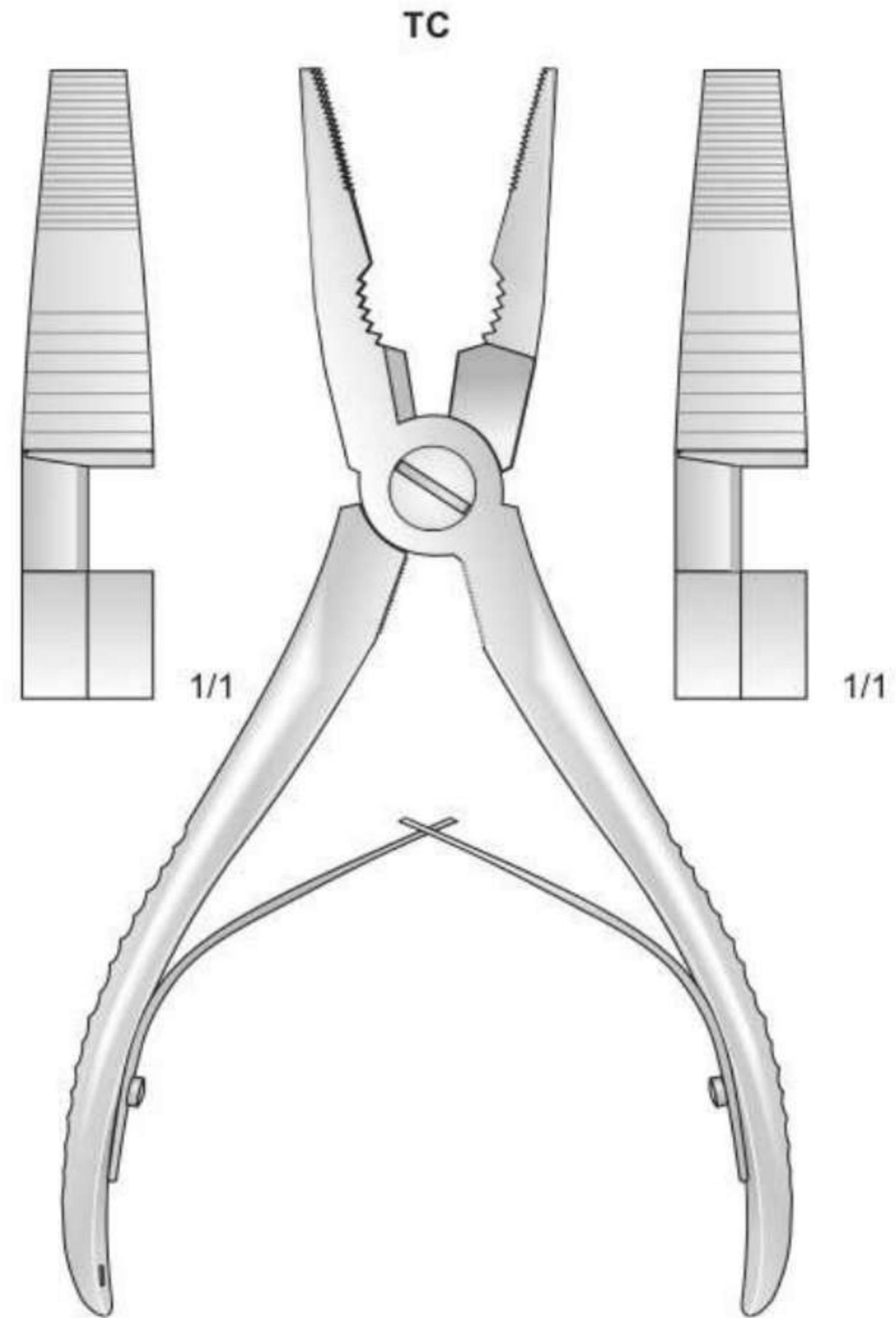

LX-136
165 mm

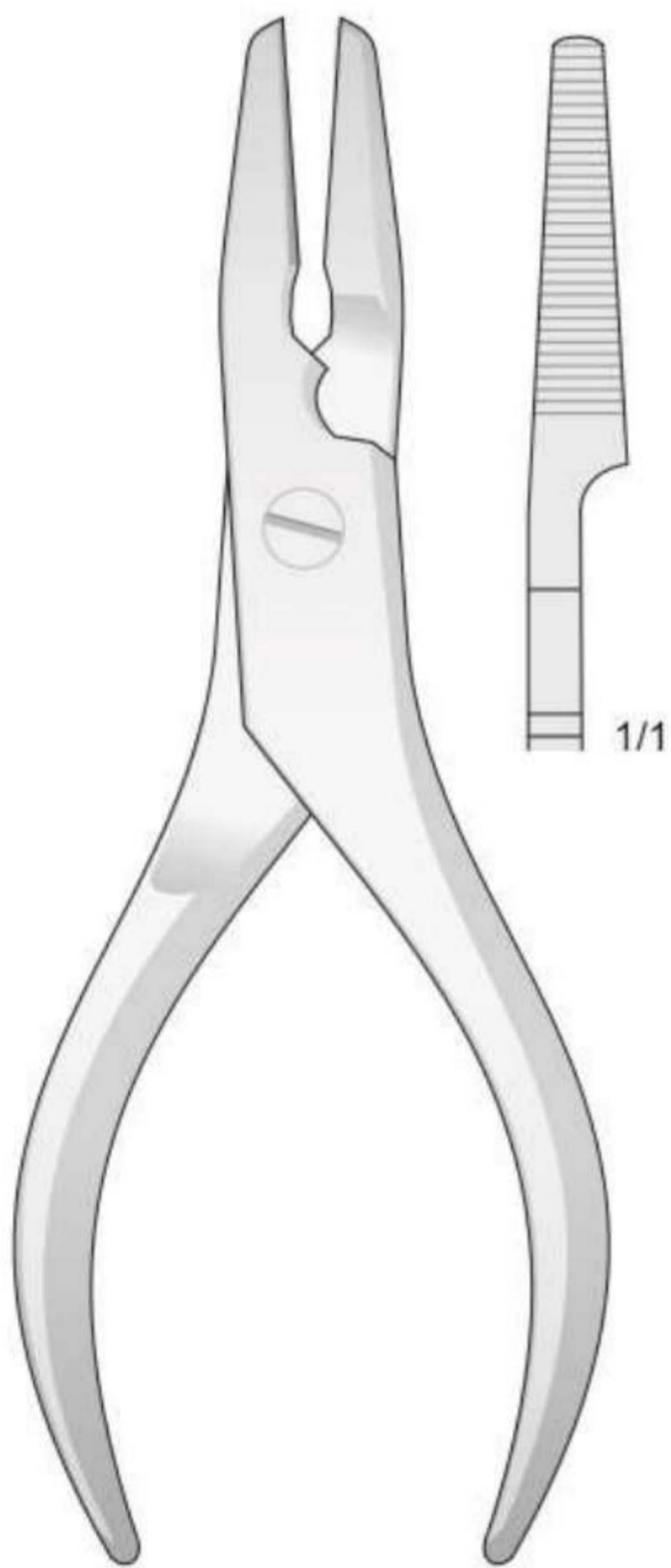

LX-134
160 mm

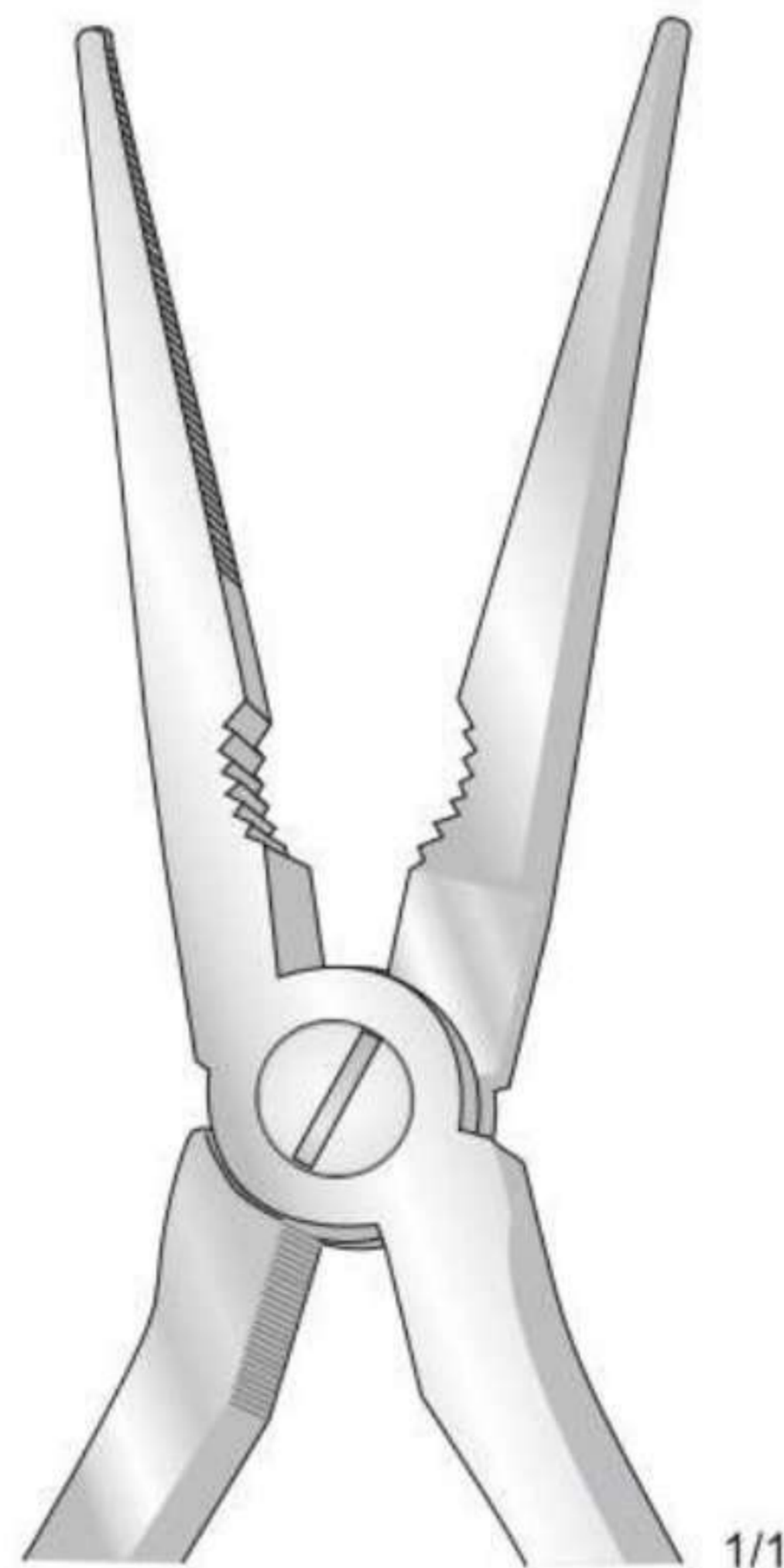

LX-137
200 mm

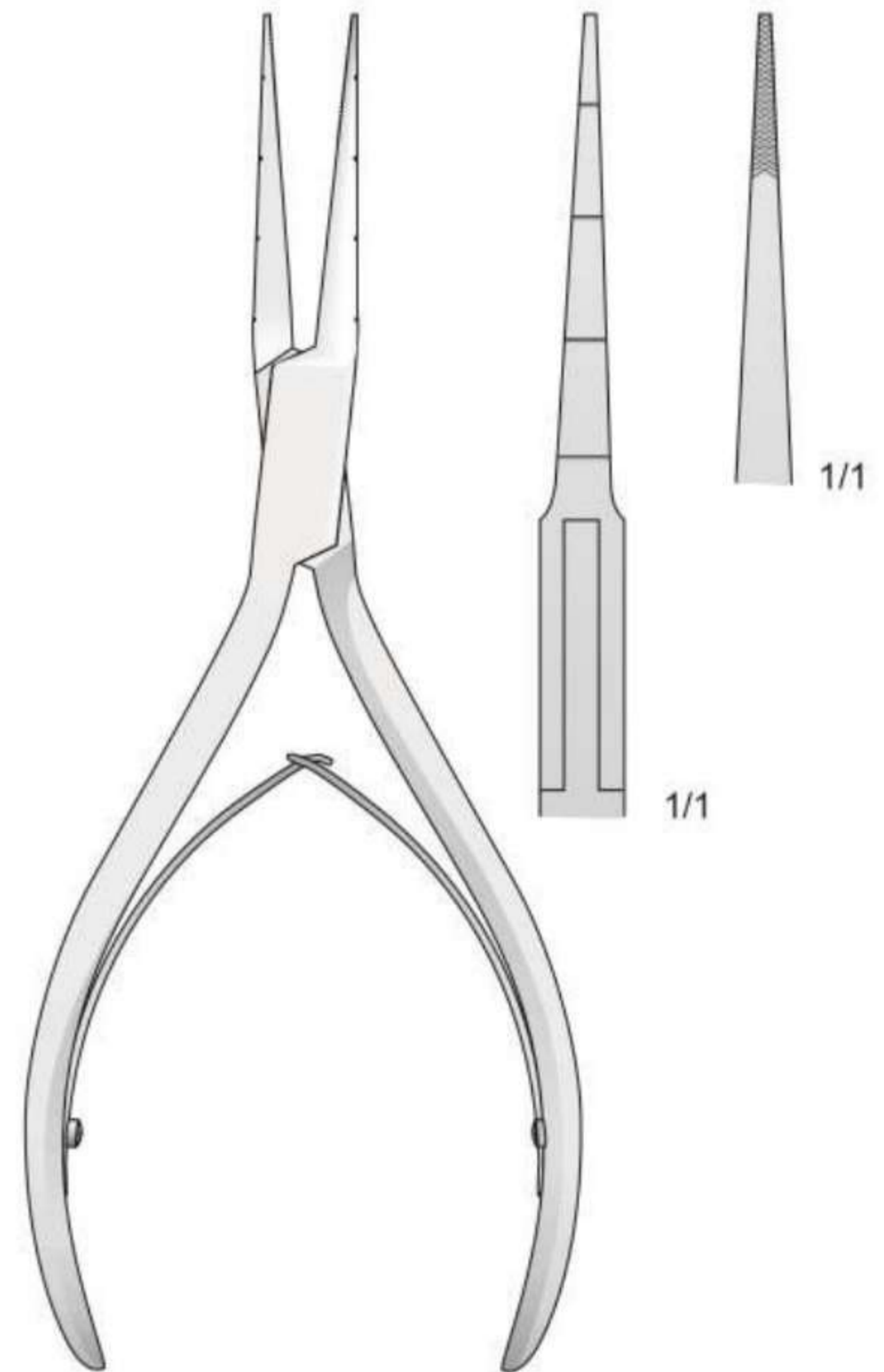

DP-96
150 mm

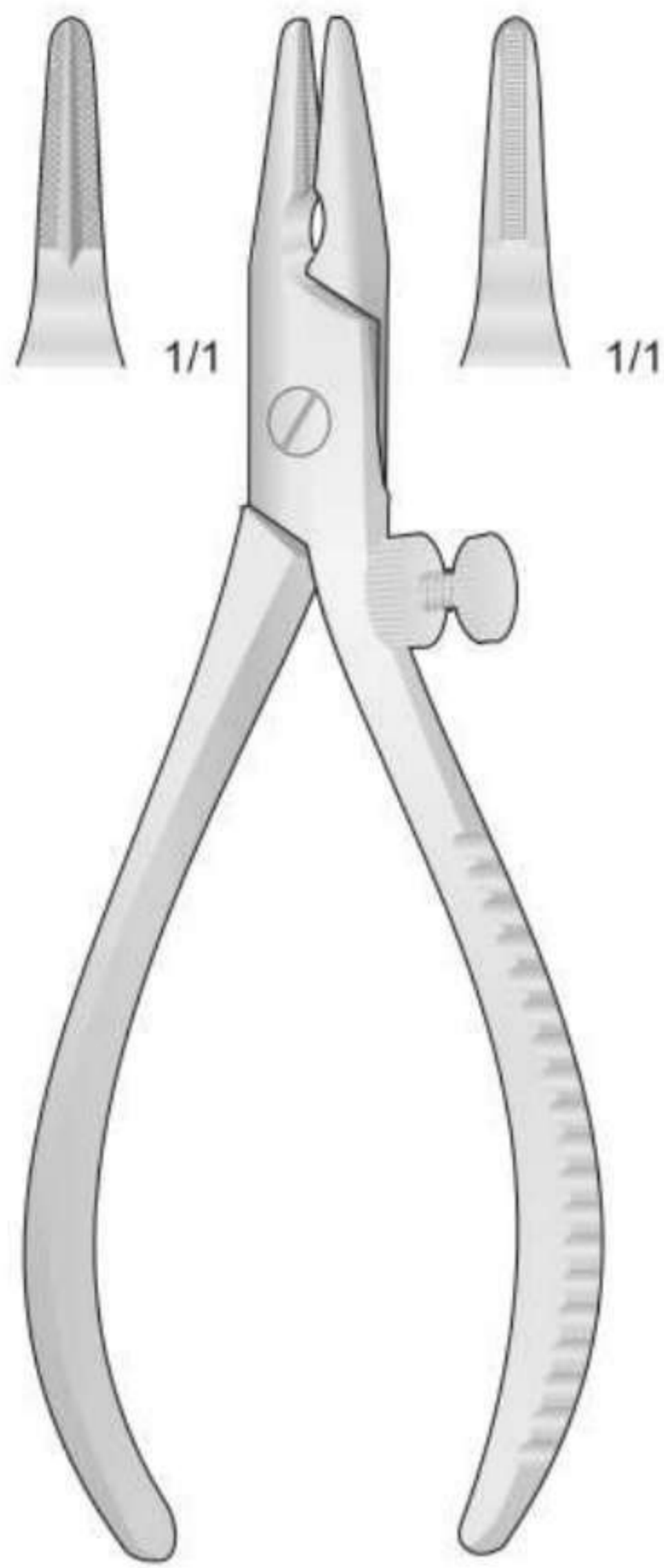

LX-130
140 mm

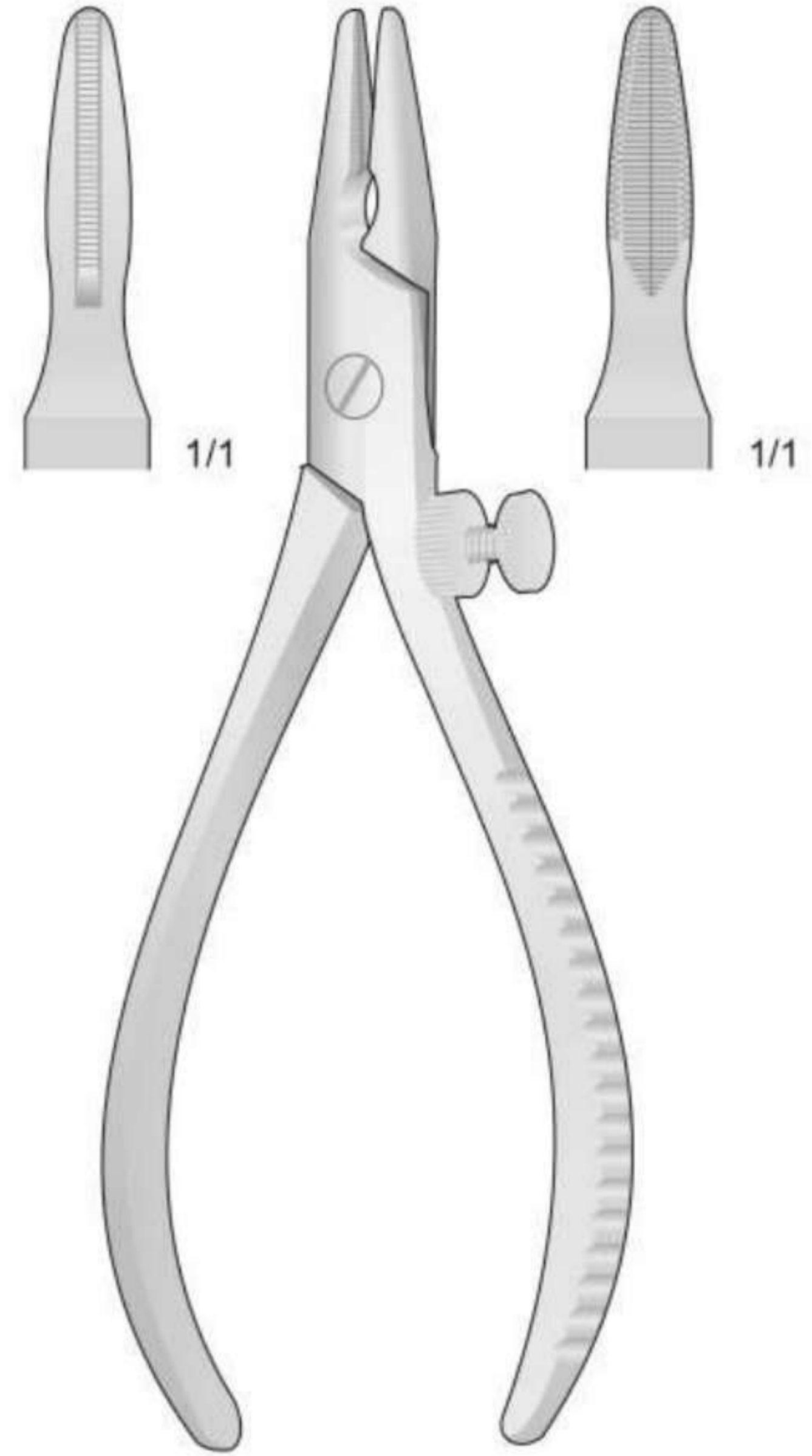

LX-131
180 mm

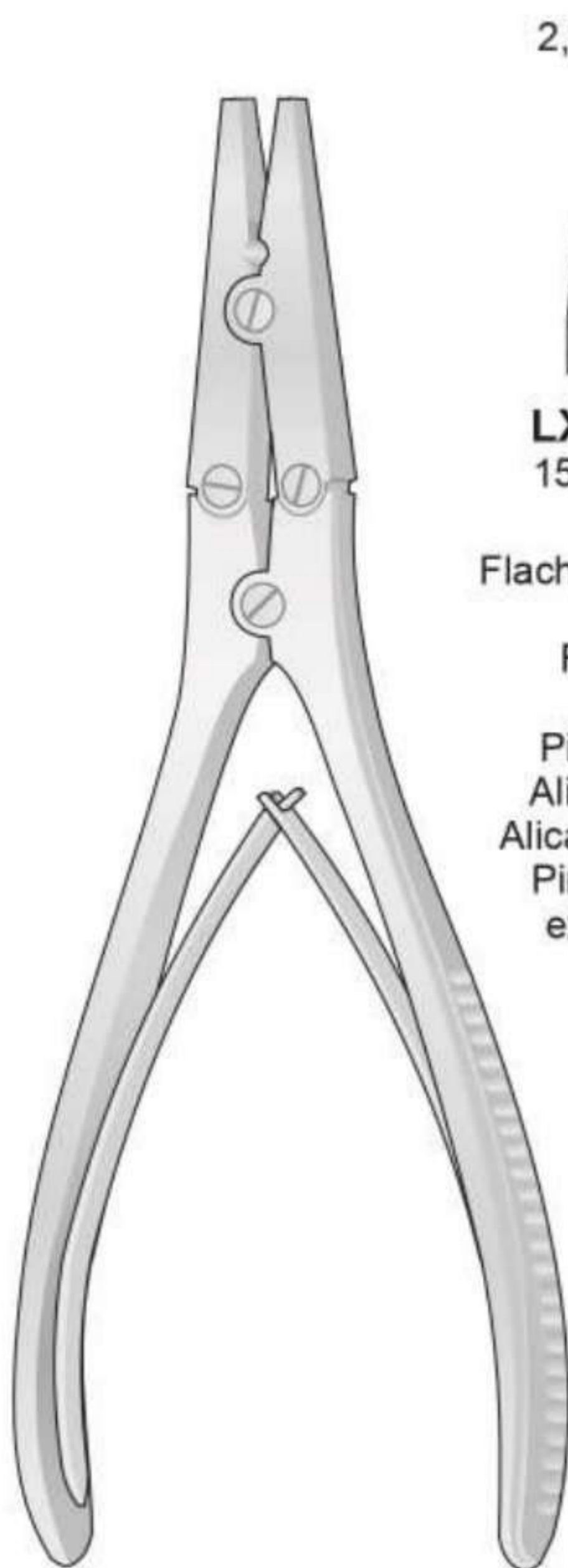

LX-138/LX-139

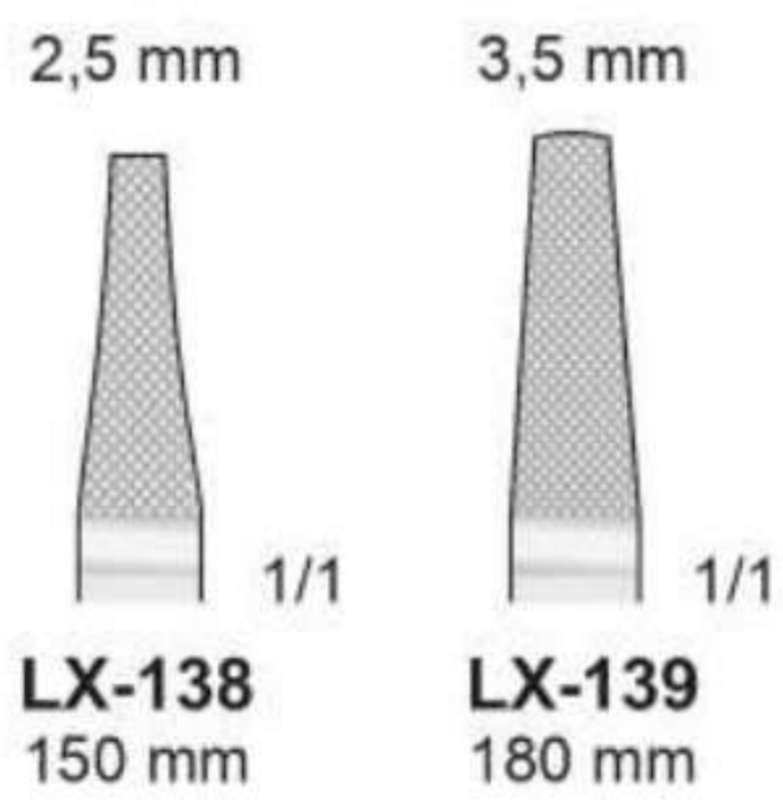

Flachzange, Extraktionszange für Bohrdrähte
 Flat pliers, Extraction pliers for wires
 Pinze per estrazione fili
 Alicates para extracción, Alicates para sacar alambre
 Pince plate, Pincers pour extraction des broches

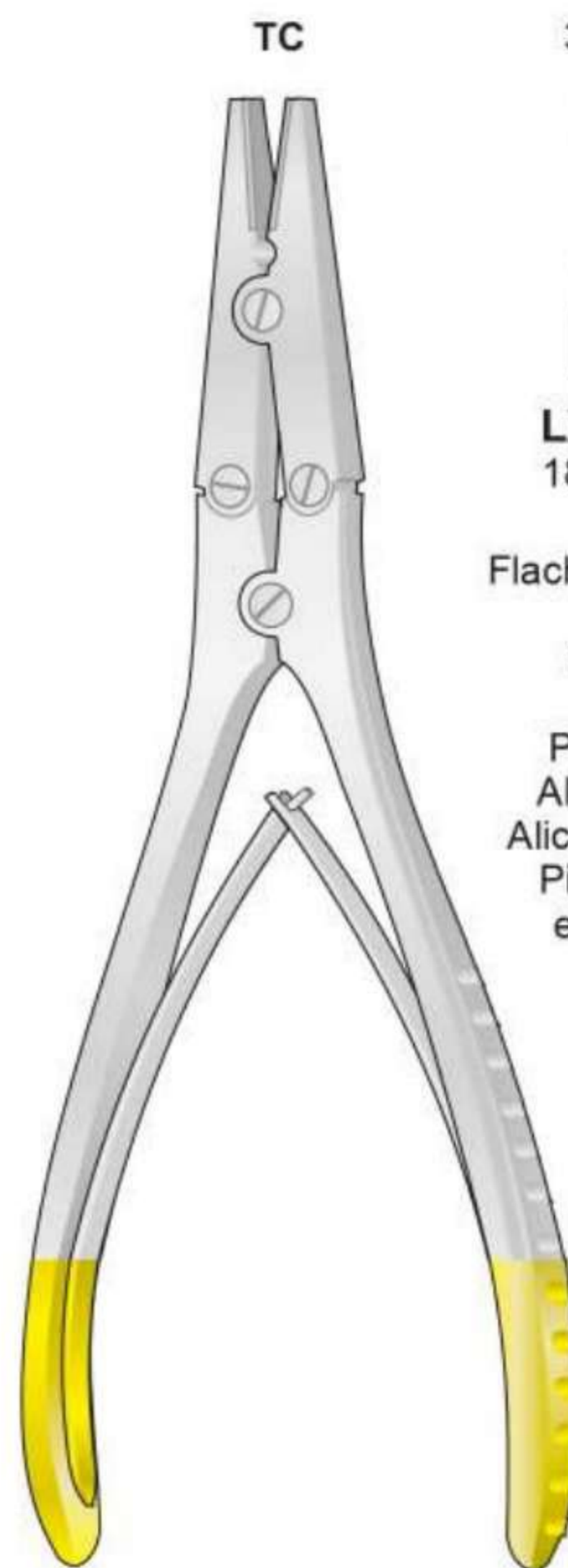

LX-140/LX-141

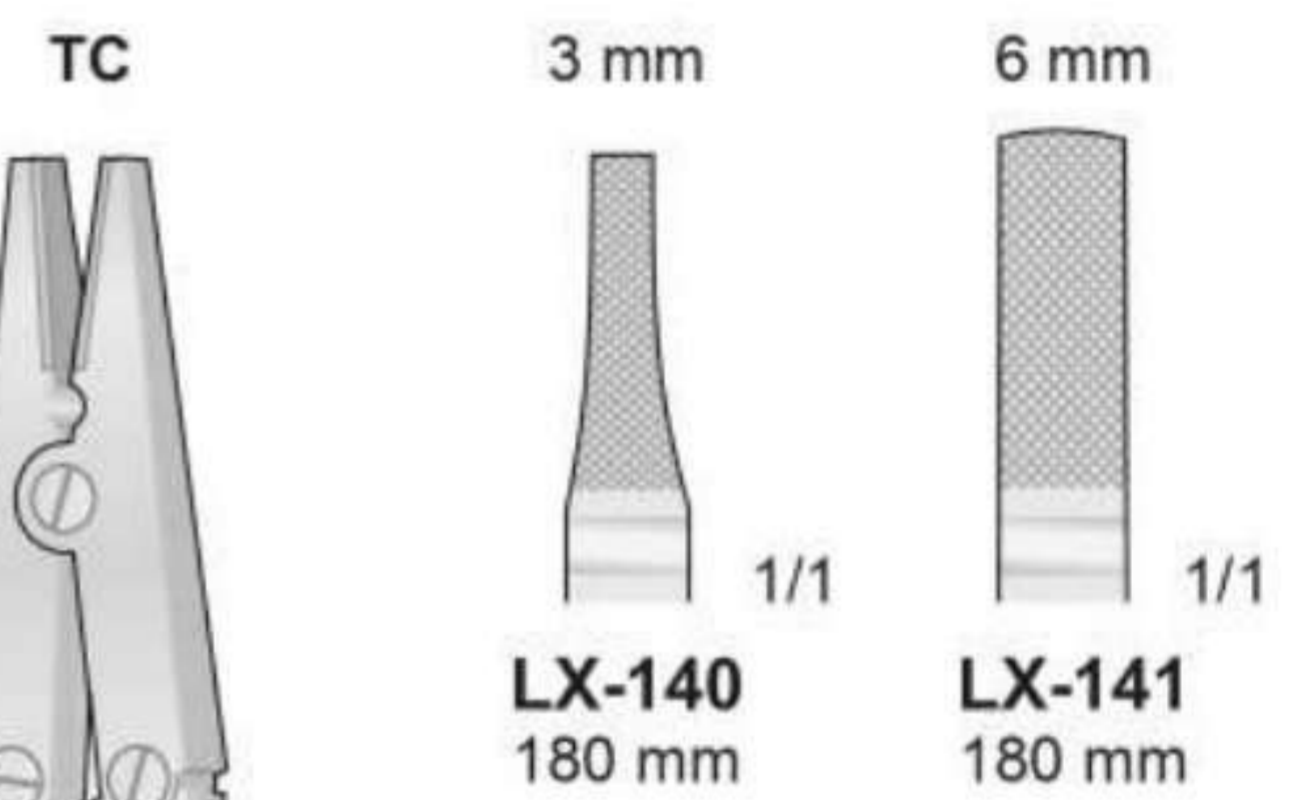

Flachzange, Extraktionszange für Bohrdrähte
 Flat pliers, Extraction pliers for wires
 Pinze per estrazione fili
 Alicates para extracción, Alicates para sacar alambre
 Pince plate, Pincers pour extraction des broches

Extraktionszangen
für bohrdrähte

Extraction pliers
for wire

Pinze d'estrazione
per fili metallici

Pinzas de extracción
para hilo metálico

Pinces pour l'extraction
pour fil métallique



VH-20

1/1

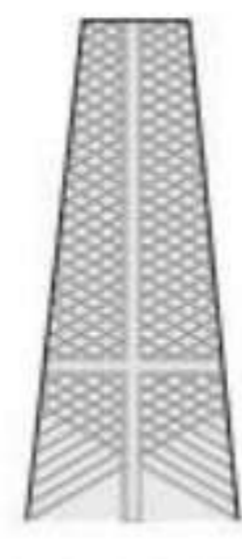

VH-21

1/1

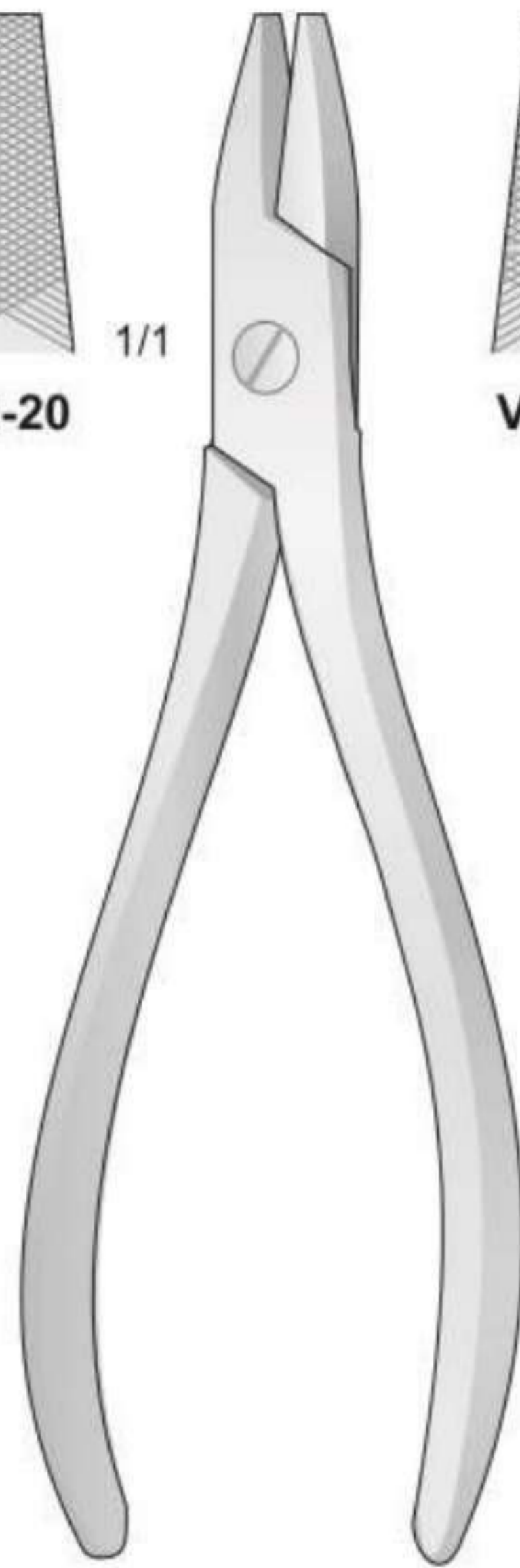

VH-20/VH-21
175 mm

Parallel-Flachzange - Flat-nosed pliers, parallel
Pinza a branche parallele - Alicates planos - Pinces plates



1/1



1/1

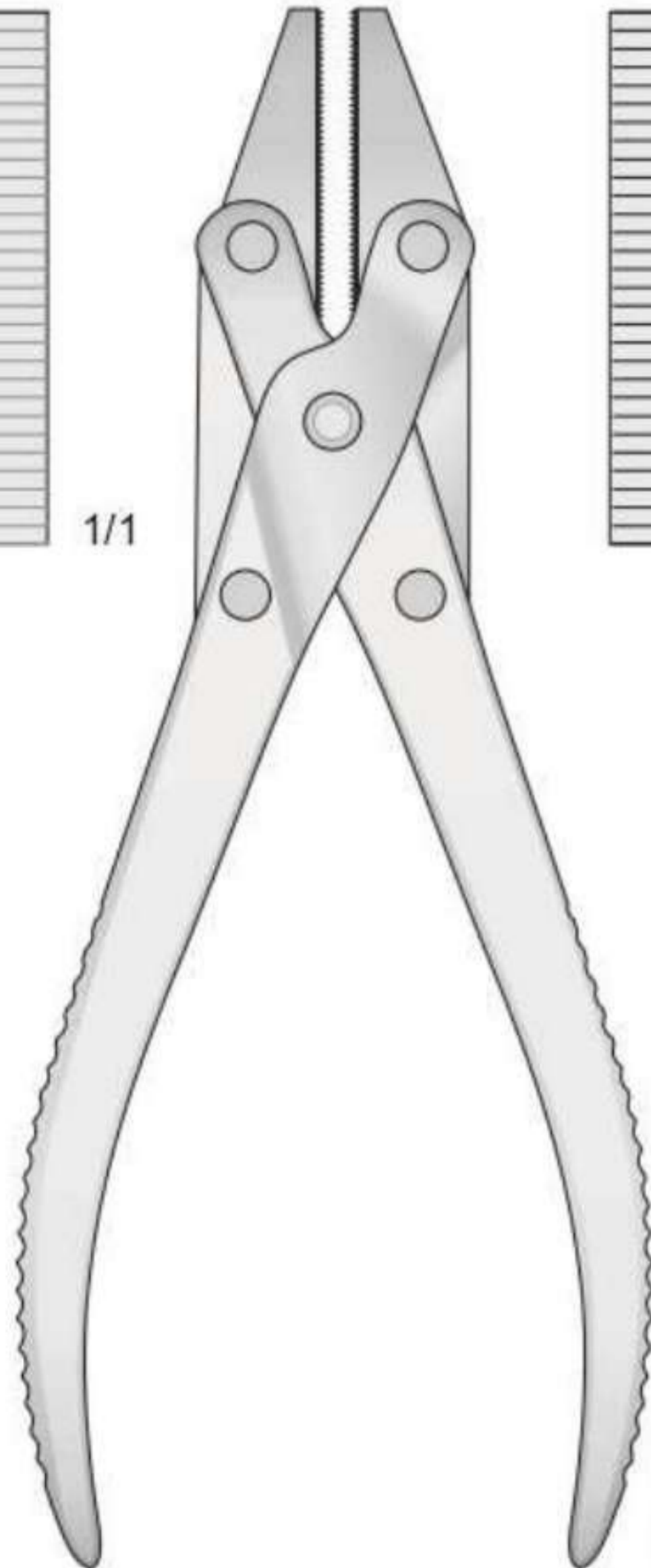

VH-25
185 mm

Inox
Stainless Steel
Rostfrei

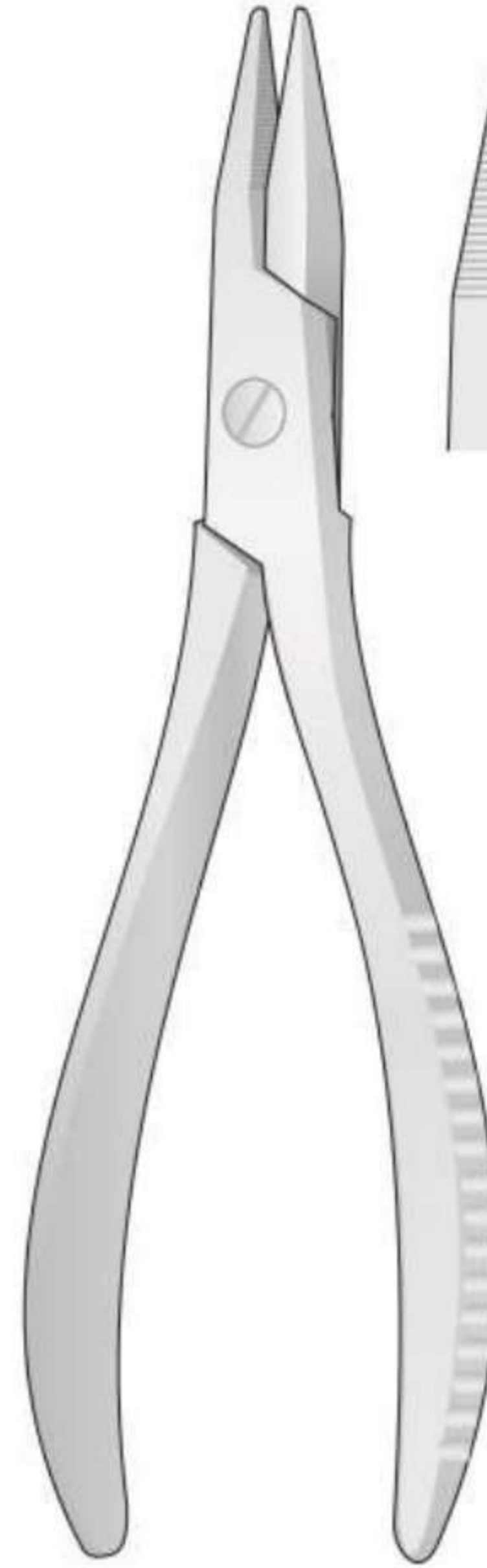

VH-23
190 mm

Parallel-Flachzange mit Seitenschneider
Flat-nose pliers parallel with lateral wire cutter
Pinza a branche parallele con tronchese

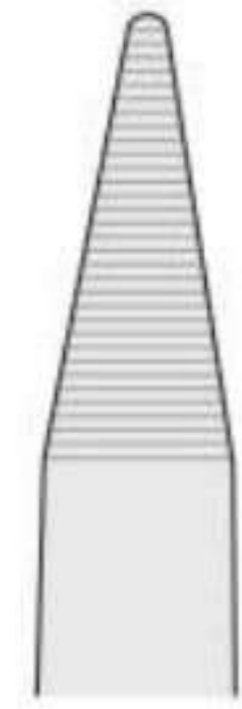

1/1



1/1



1/1

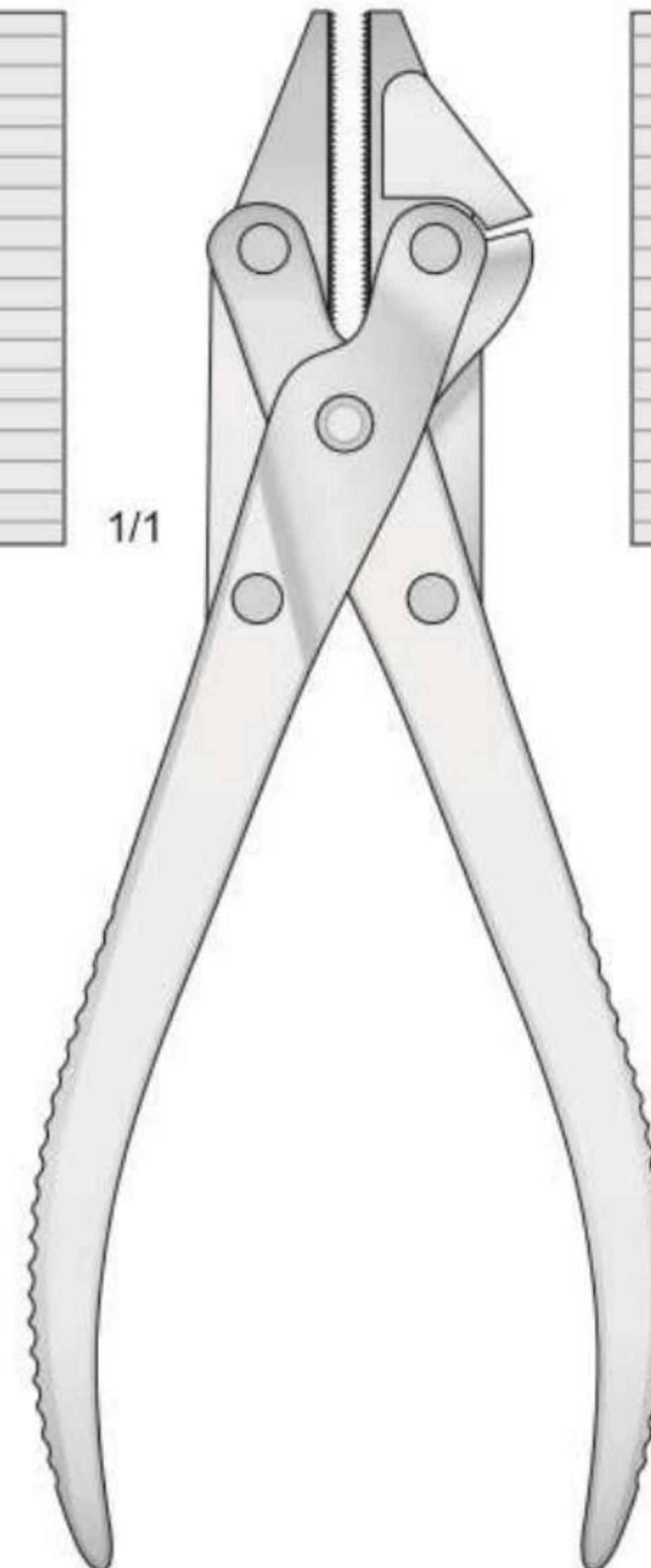

LX-80
185 mm

Inox
Stainless Steel
Rostfrei

Extraktionszangen
für bohrdrähte

Extraction pliers
for wire

Pinze d'estrazione
per fili metallici

Pinzas de extracción
para hilo metálico

Pinces pour l'extraction
pour fil métallique

TC

Draht-und blehschere gezahnt - Wire cutting scissor serrated
Forbice universale dentellata - Tijeras para cortar hilo de acero dentadas

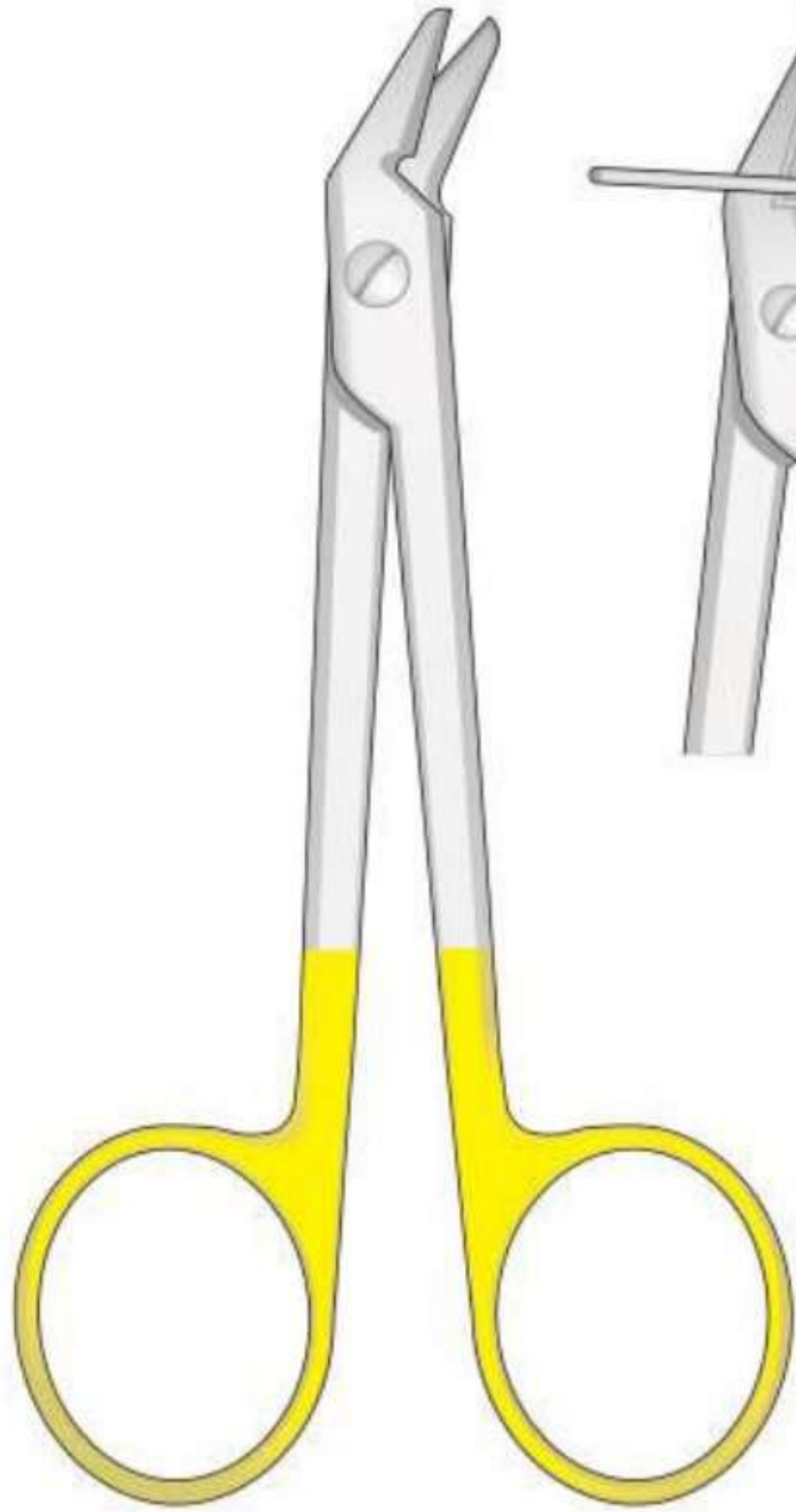

DP-120
120 mm

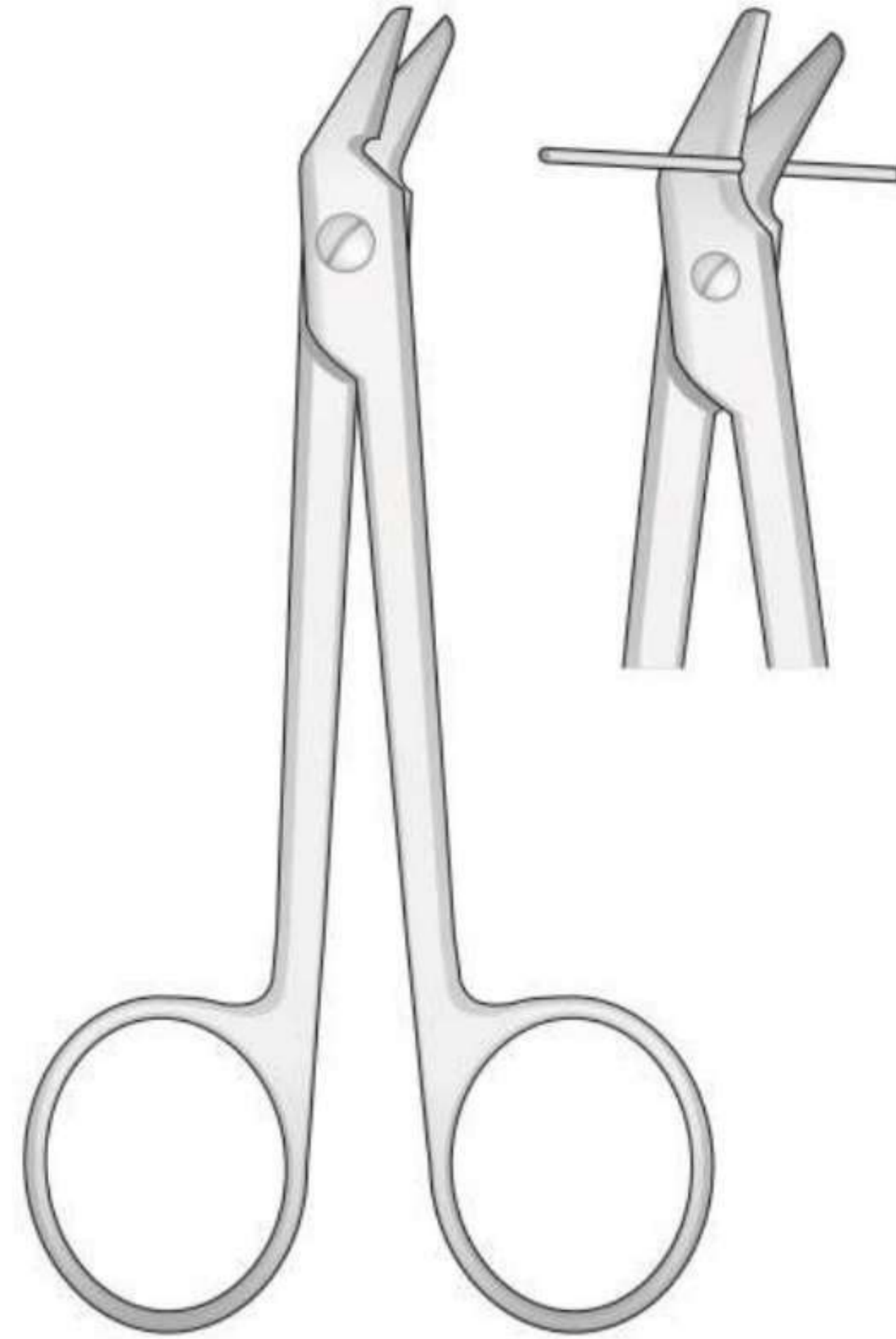

DP-90
120 mm

TC

Con tronchese
per kirschner Ø 1,5 mm

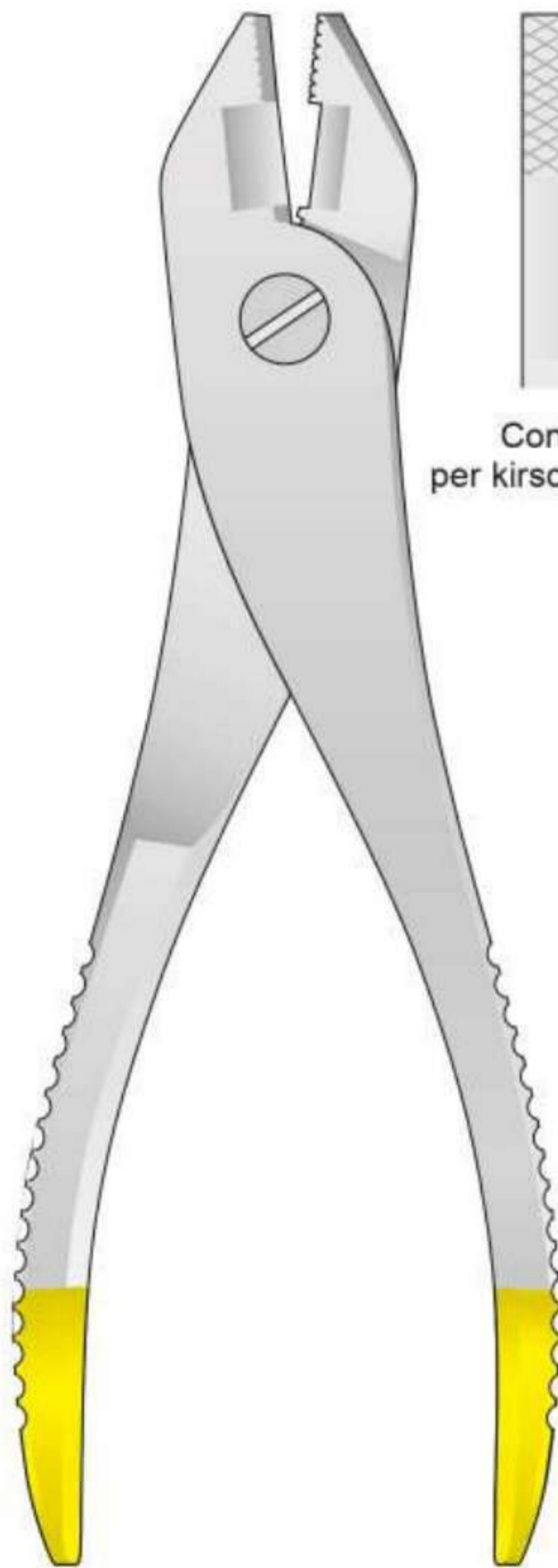

LX-125
220 mm

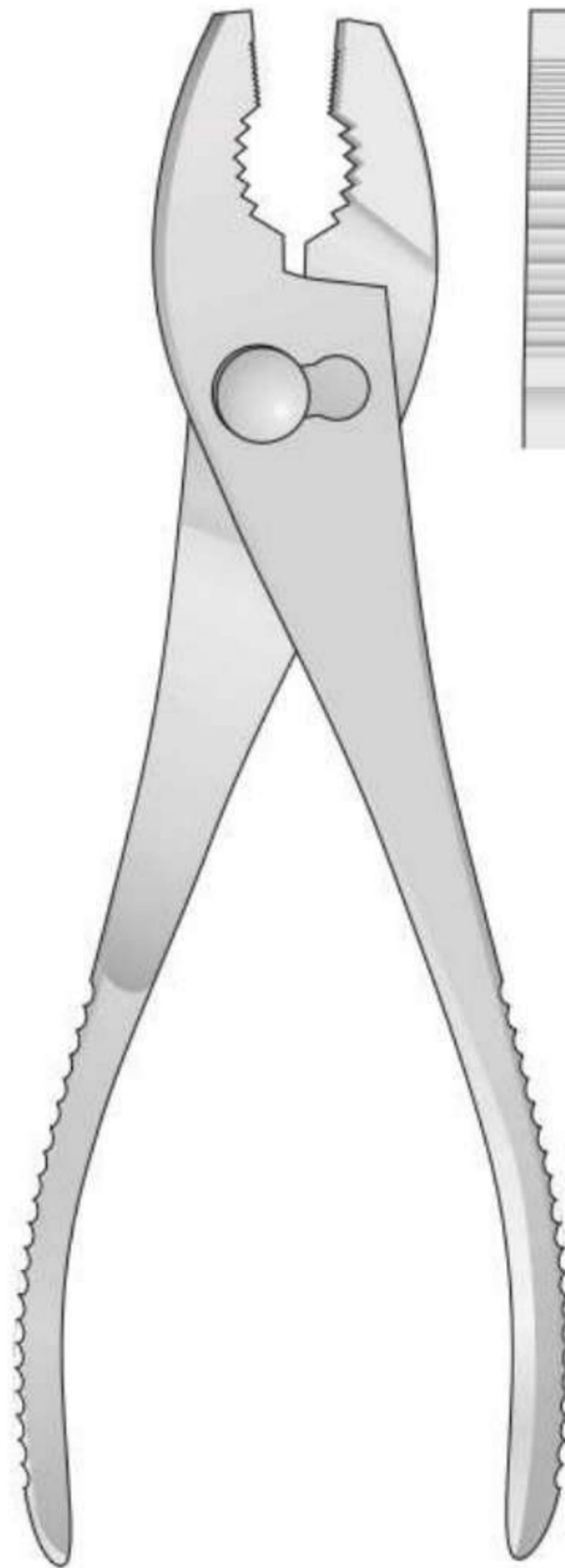

VH-40
200 mm

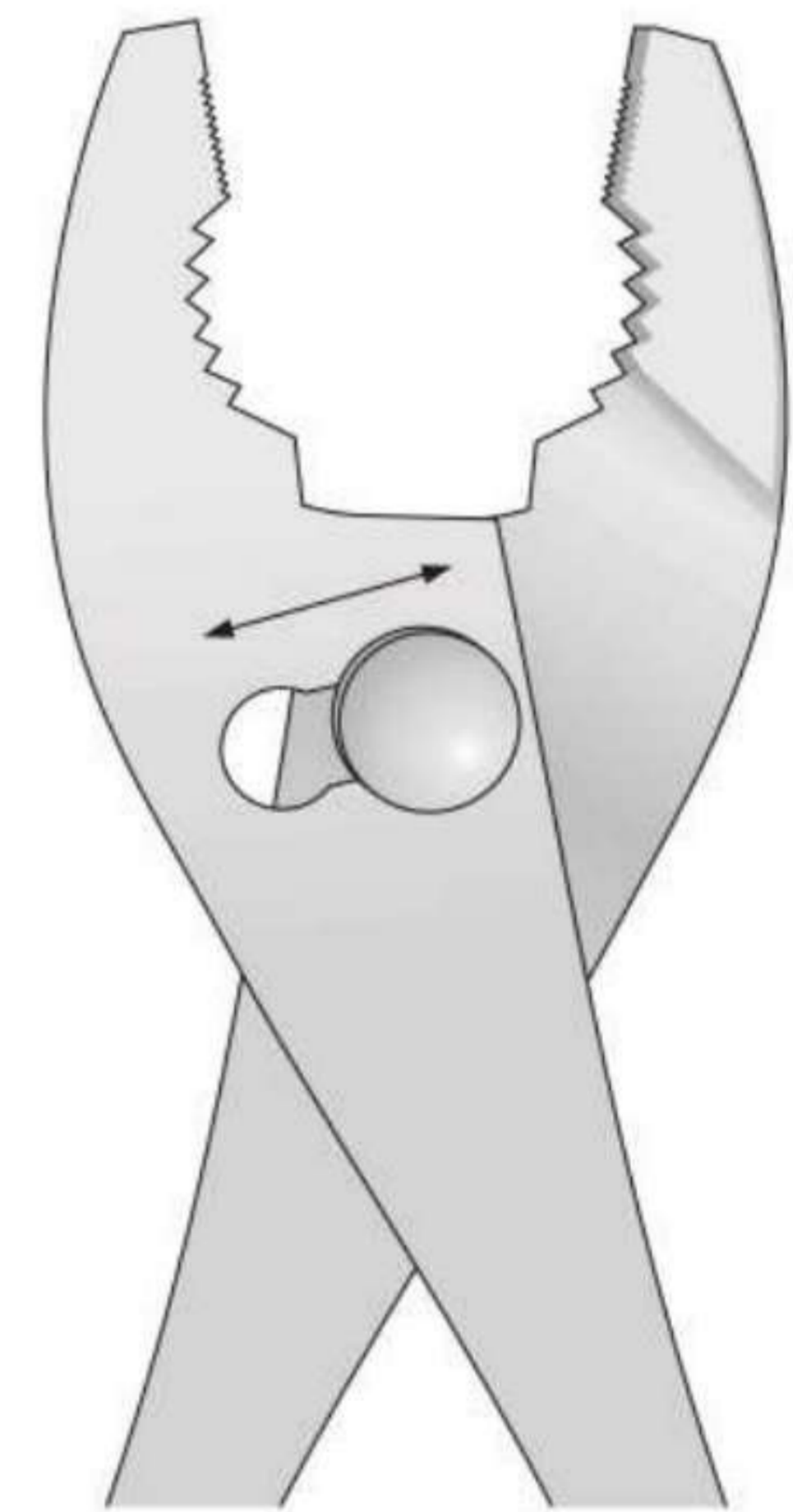

Feststellzange

Locking Pliers

Pinze di bloccaggio

Pinzas de presión

Pince-étau

Komplett aus rostfreiem Stahl gefertigte und gehärtete Backen sorgen für einen guten Halt. Spannen und lösen erfolgt mit einer Hand



LS-407
180 mm



LS-408
200 mm



LS-409
240 mm

Nadelhalter
für drähte

Needle Holders
for wire

Port'aghi
per fili metallici

Portaagujas
para hilo metálico

Porte aiguilles
pour fil métallique

Needle Holder | Wire Forceps
Nadelhalter | Draht-Zangen
Porte-aiguilles | Pincés pour fil
Porta-agujas | Pinzas para alambre
Port'aghi | Pinze per fili

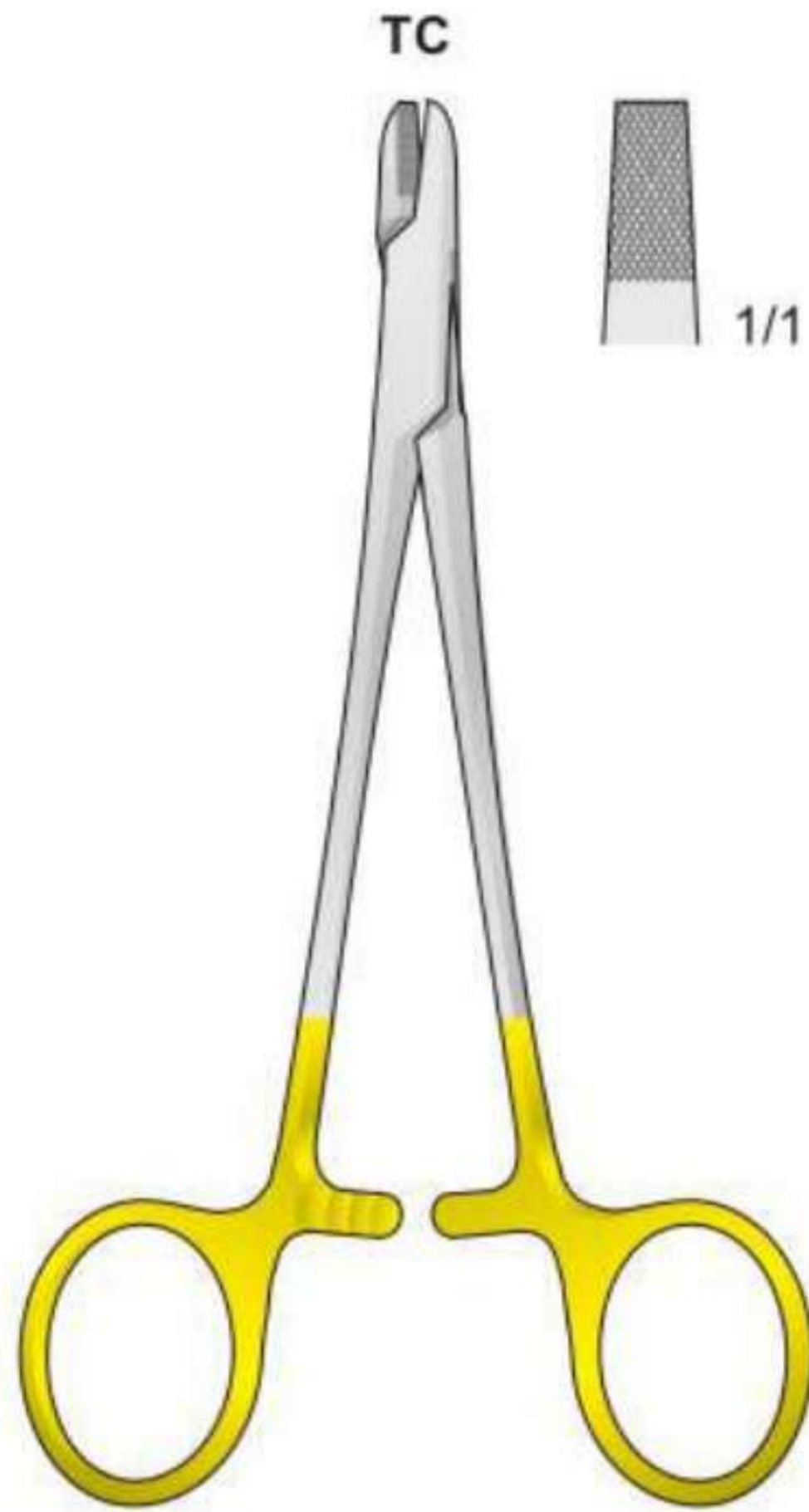

PH-58
150 mm

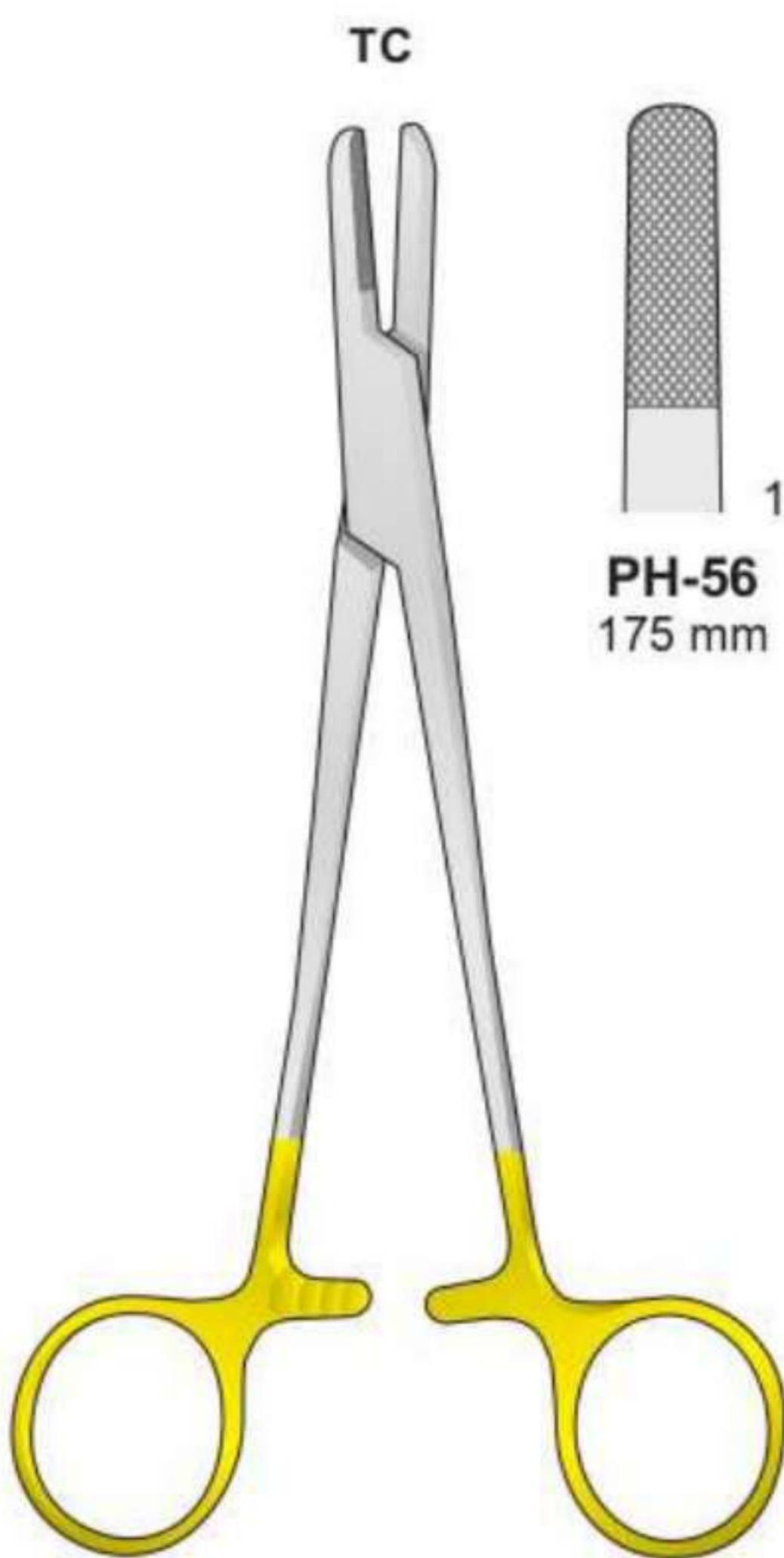

PH-55/PH-56

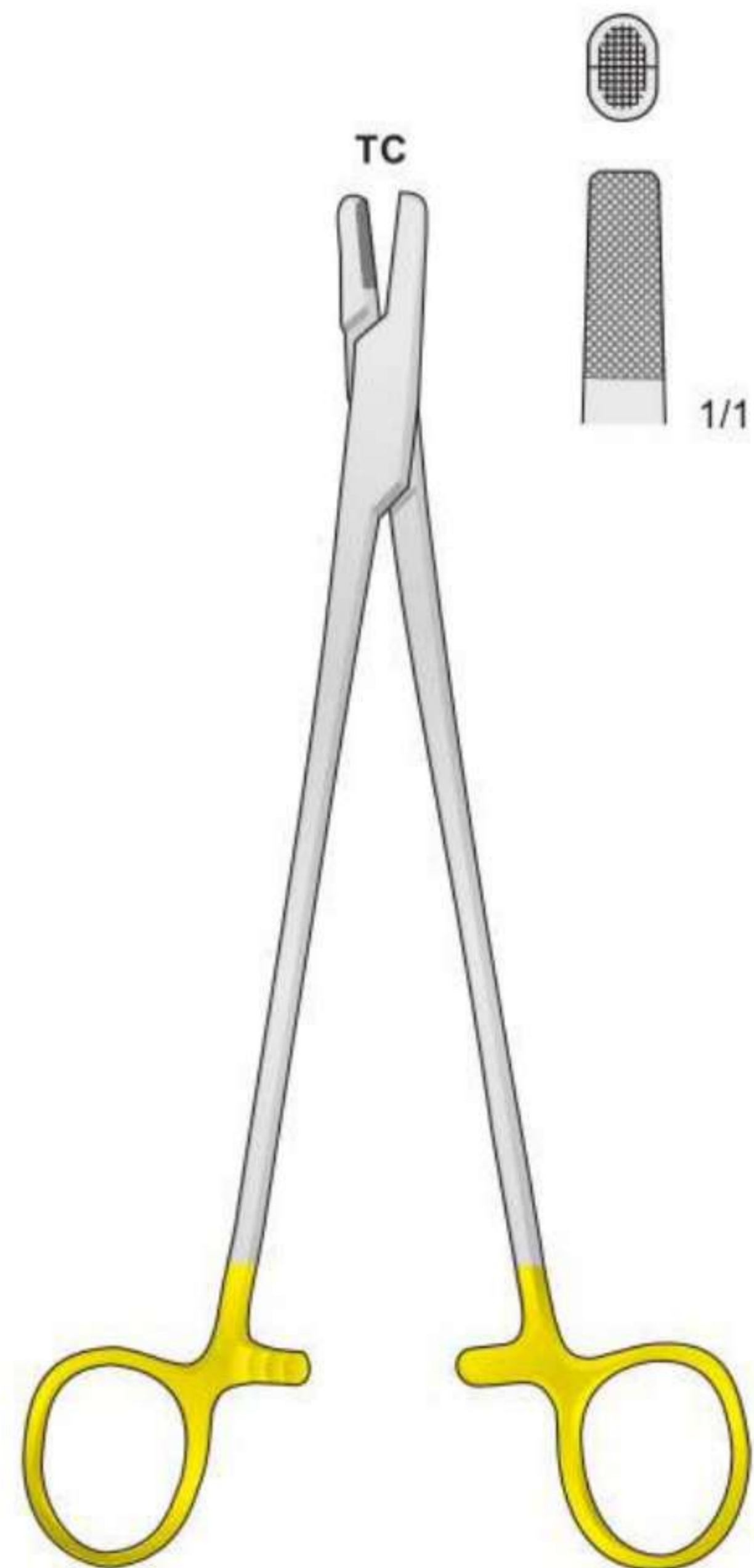
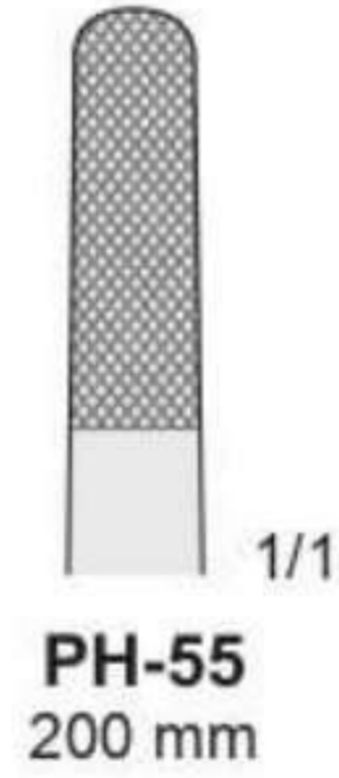
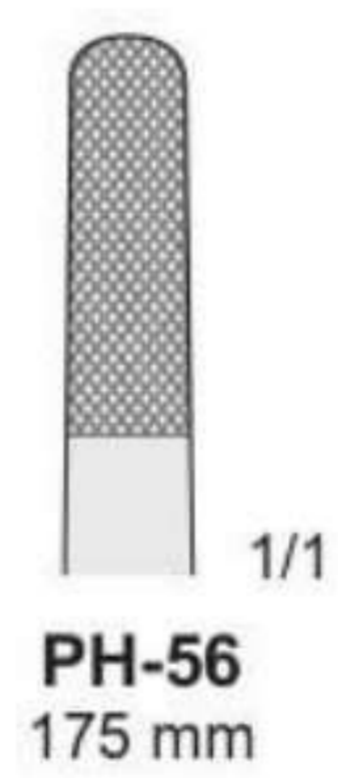

BAUMGARTNER
PH-57
200 mm

Für harten Draht bis \varnothing 0,4 mm - For hard wire with \varnothing 0,4 mm
 Per fili duri di \varnothing 0,4 mm - Para alambres duros de \varnothing 0,4 mm
 Pour fils durs avec \varnothing 0,4 mm

Für harten Draht bis \varnothing 1 mm - For hard wire with \varnothing 1 mm
 Per filo duro \varnothing 1 mm - Para alambres duro \varnothing 1 mm
 Pour fil dur avec \varnothing 1 mm

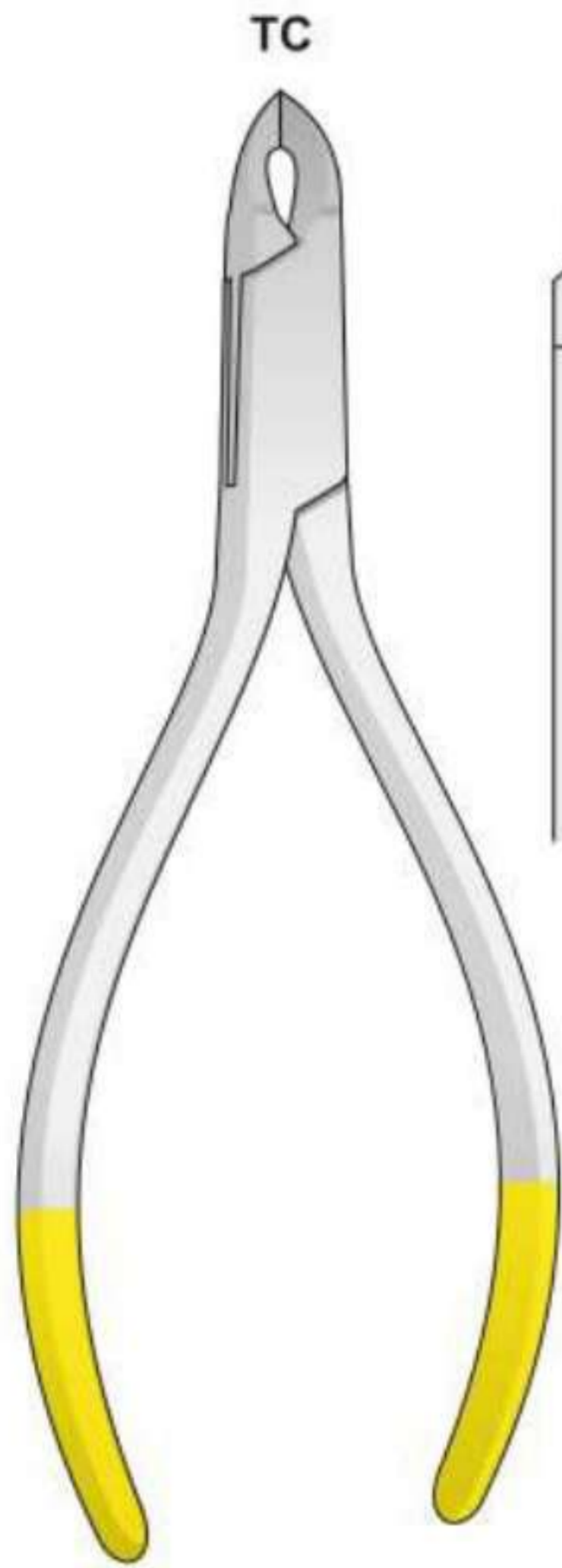

ANGLE
LX-95TC
 130 mm

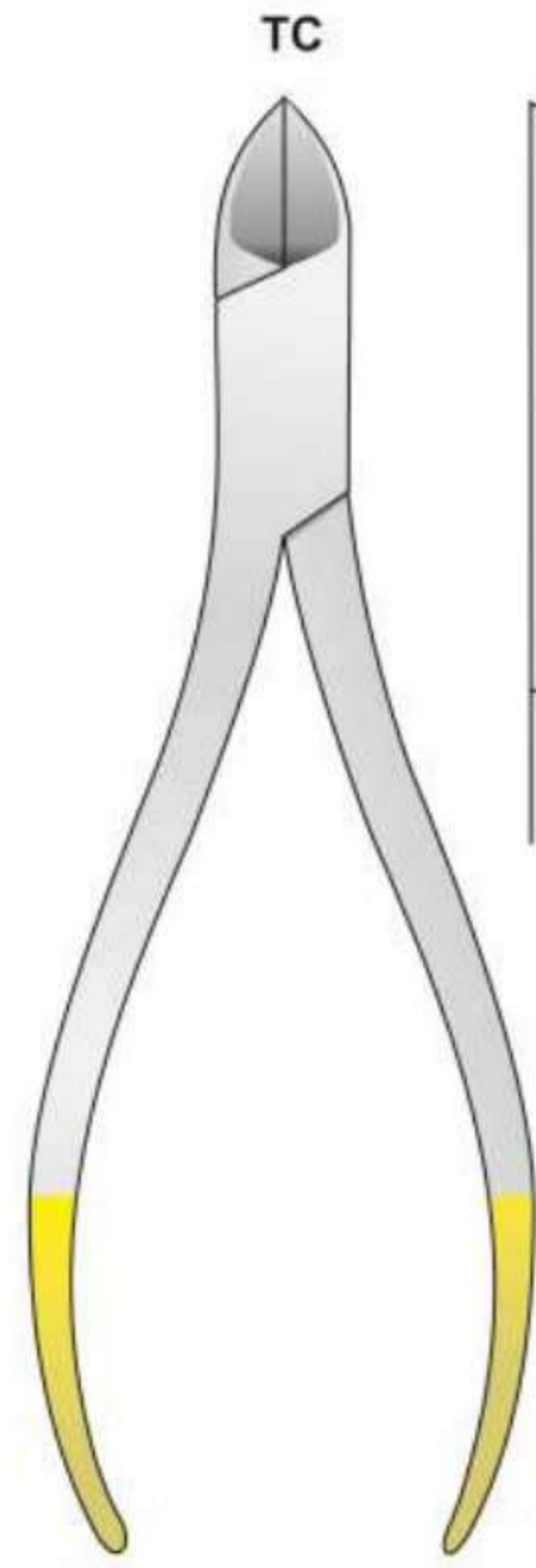

LX-99
 130 mm

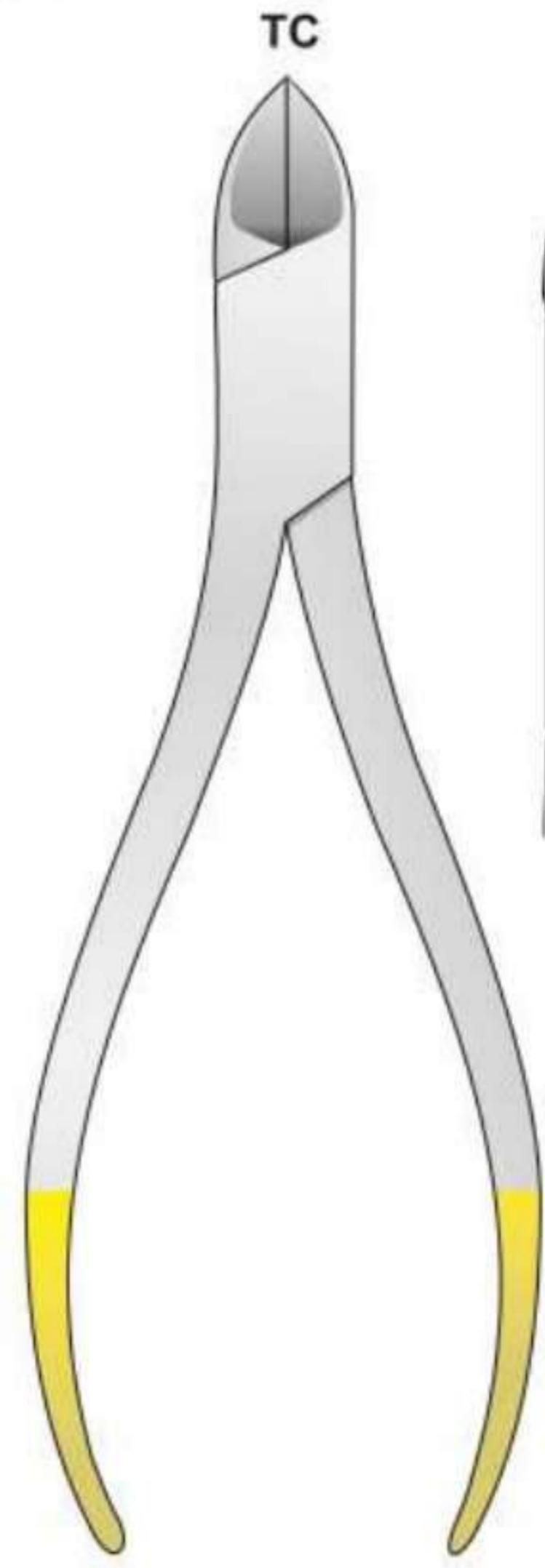

LX-96TC
 150 mm

Für harten Draht bis \varnothing 1 mm - For hard wire with \varnothing 1 mm
 Per filo duro \varnothing 1 mm - Para alambres duro \varnothing 1 mm
 Pour fil dur avec \varnothing 1 mm

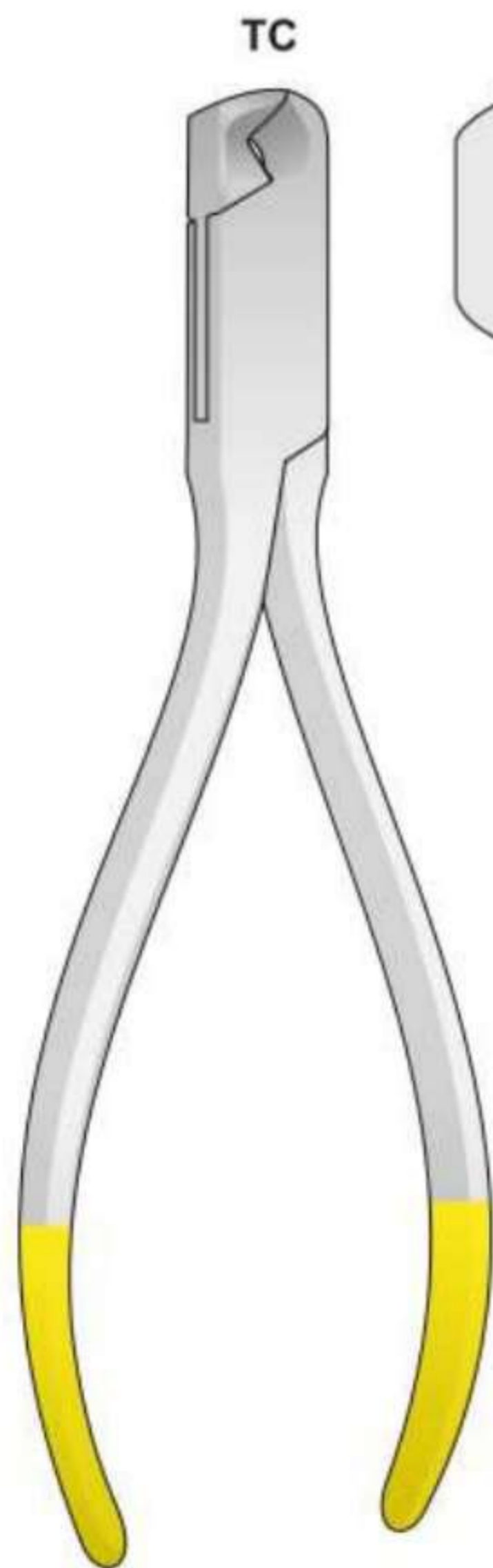

LX-92TC
 145 mm



LX-82
 185 mm

Für harten Draht bis \varnothing 1,7 mm
 For hard wire with \varnothing 1,7 mm
 Per filo duro \varnothing 1,7 mm
 Para alambres duro \varnothing 1,7 mm
 Pour fil dur avec \varnothing 1,7 mm

Für weichen draht Ø 2 mm
 Für harten draht Ø 1,5 mm
 For soft wire Ø 2 mm
 For hard wire Ø 1,5 mm
 Per filo leggero Ø 2 mm
 Per filo duro Ø 1,5 mm
 Para alambres ligero Ø 2 mm
 Para alambres duro 1,5 mm
 Pour fil léger Ø 2 mm
 Pour fil dur Ø 1,5 mm

Für weichen draht Ø 2 mm
 Für harten draht Ø 1,6 mm
 For soft wire Ø 2 mm
 For hard wire Ø 1,6 mm
 Per filo leggero Ø 2 mm
 Per filo duro Ø 1,6 mm
 Para alambres ligero Ø 2 mm
 Para alambres duro Ø 1,6 mm
 Pour fil léger Ø 2 mm
 Pour fil dur Ø 1,6 mm

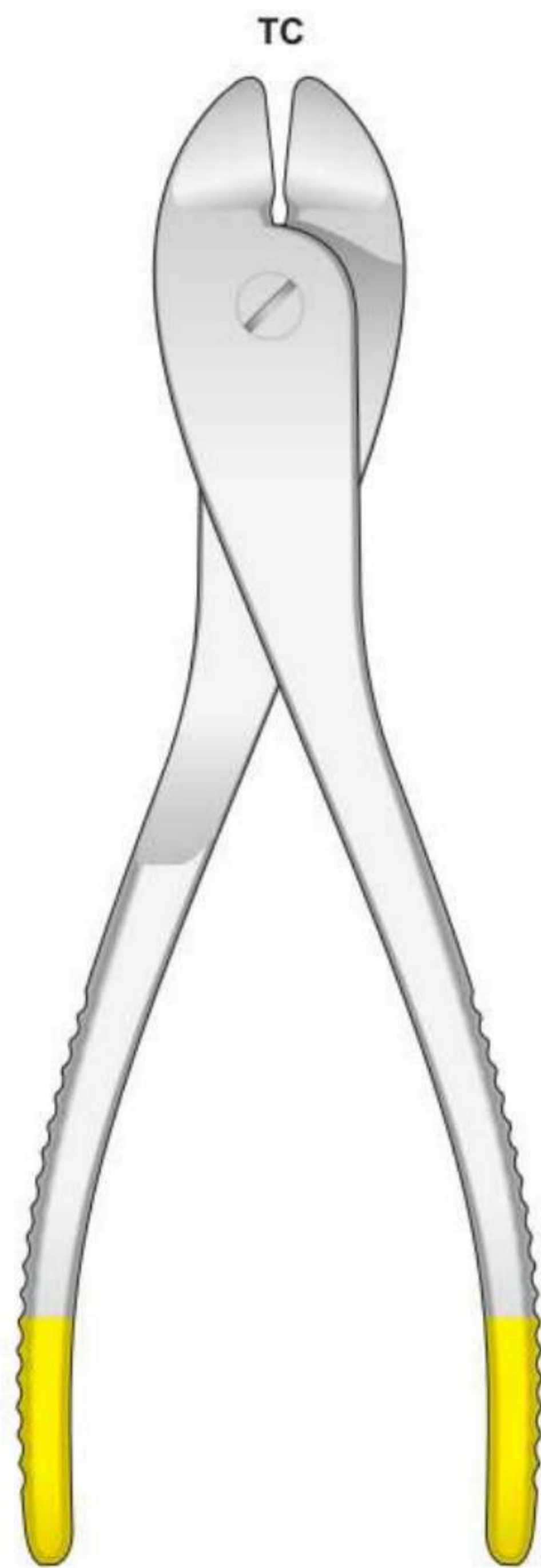

LX-101
185 mm

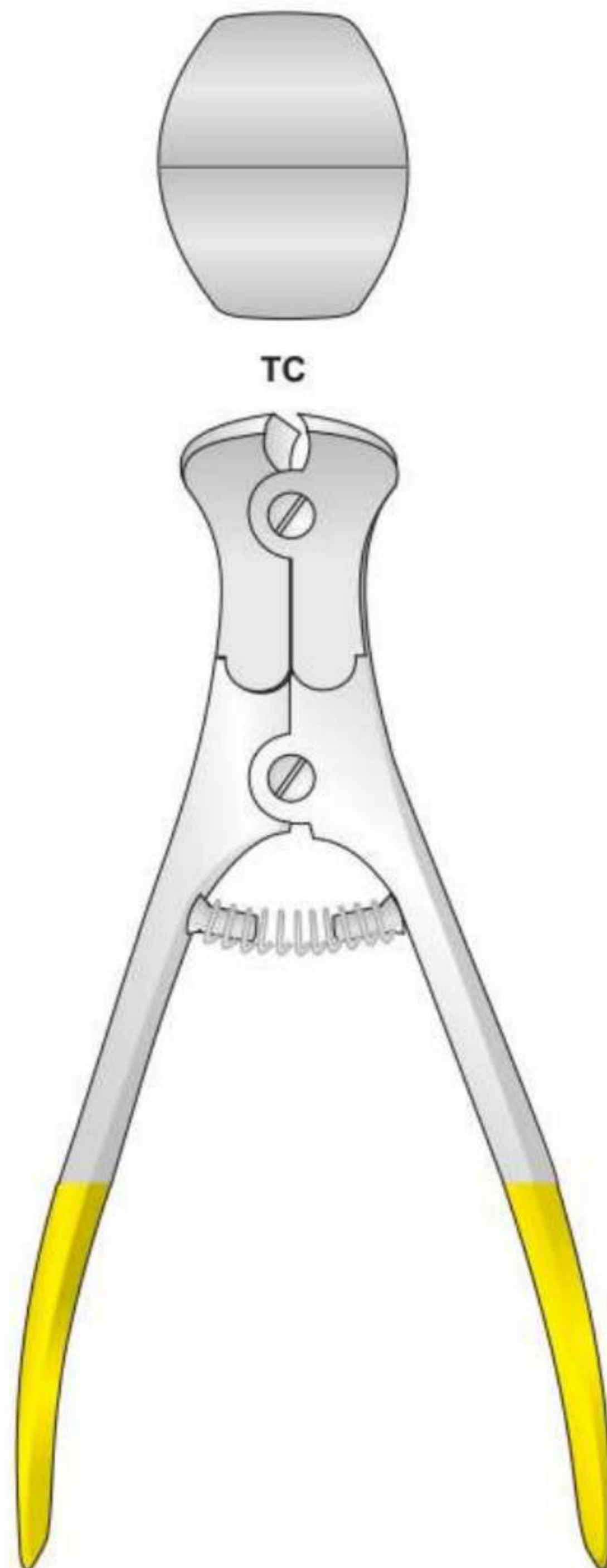

LX-102
145 mm

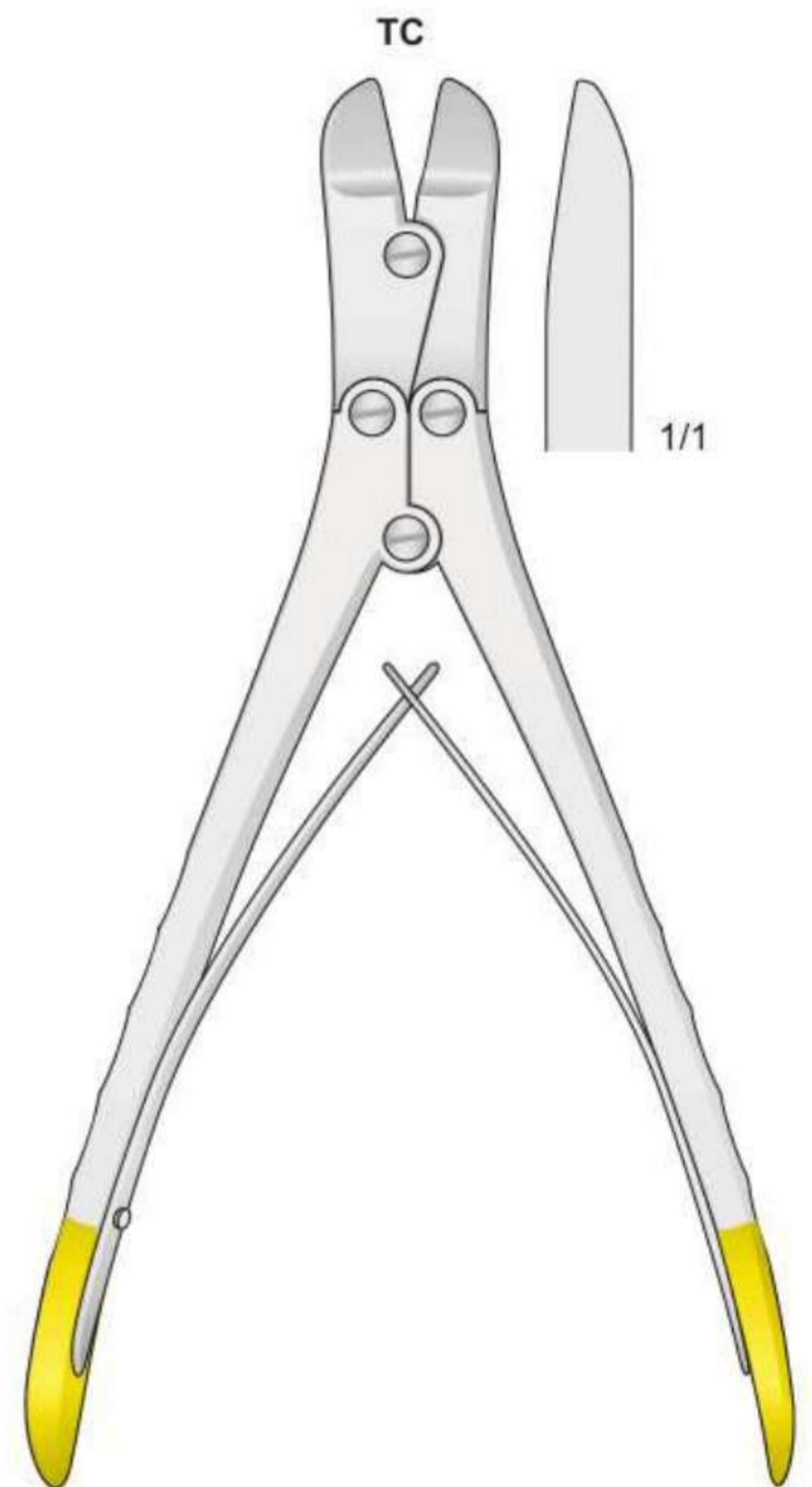

LX-103
170 mm

Für weichen draht Ø 3,5 mm
 Für harten draht Ø 2,5 mm
 For soft wire Ø 3,5 mm
 For hard wire Ø 2,5 mm
 Per filo leggero Ø 3,5 mm
 Per filo duro Ø 2,5 mm
 Para alambres ligero Ø 3,5 mm
 Para alambres duro Ø 2,5 mm
 Pour fil léger Ø 3,5 mm
 Pour fil dur Ø 2,5 mm

Für weichen draht Ø 3 mm
 Für harten draht Ø 2,2 mm
 For soft wire Ø 3 mm
 For hard wire Ø 2,2 mm
 Per filo leggero Ø 3 mm
 Per filo duro Ø 2,2 mm
 Para alambres ligero Ø 3 mm
 Para alambres duro Ø 2,2 mm
 Pour fil léger Ø 3 mm
 Pour fil dur Ø 2,2 mm

Für weichen draht Ø 2,5 mm
 Für harten draht Ø 2 mm
 For soft wire Ø 2,5 mm
 For hard wire Ø 2 mm
 Per filo leggero Ø 2,5 mm
 Per filo duro Ø 2 mm
 Para alambres ligero Ø 2,5 mm
 Para alambres duro Ø 2 mm
 Pour fil léger Ø 2,5 mm
 Pour fil dur Ø 2 mm

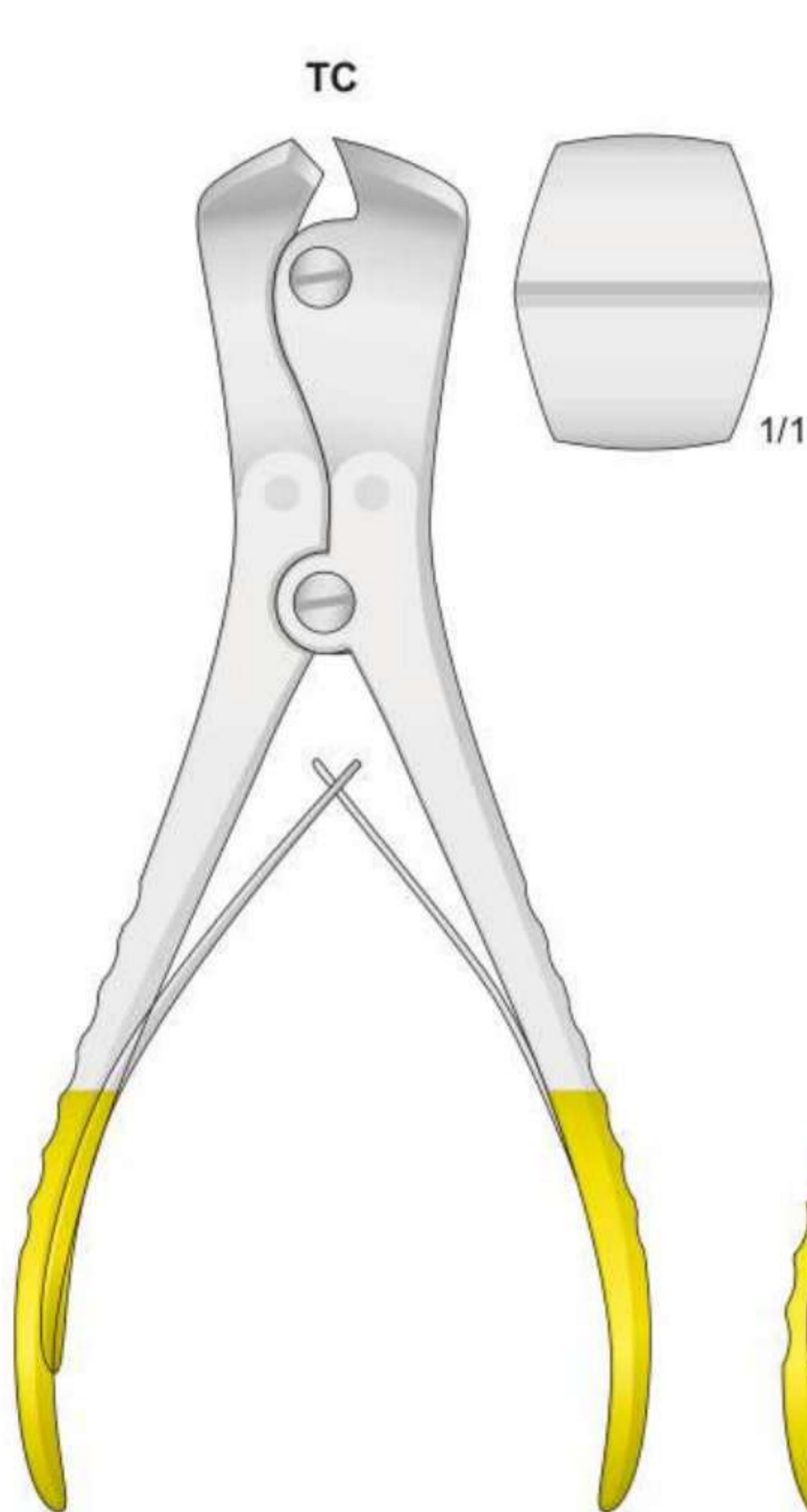

LX-104
215 mm

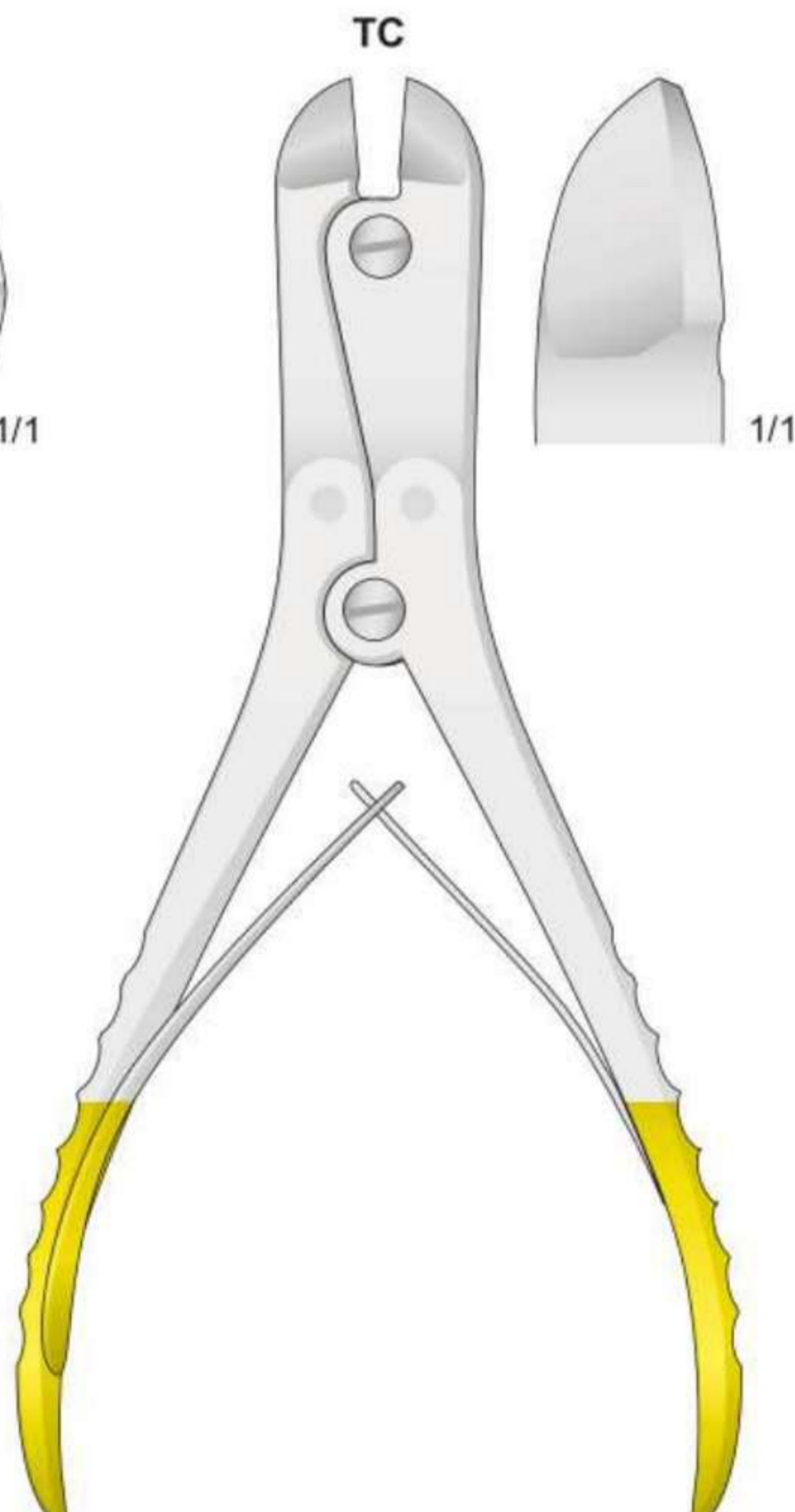

LX-106
230 mm

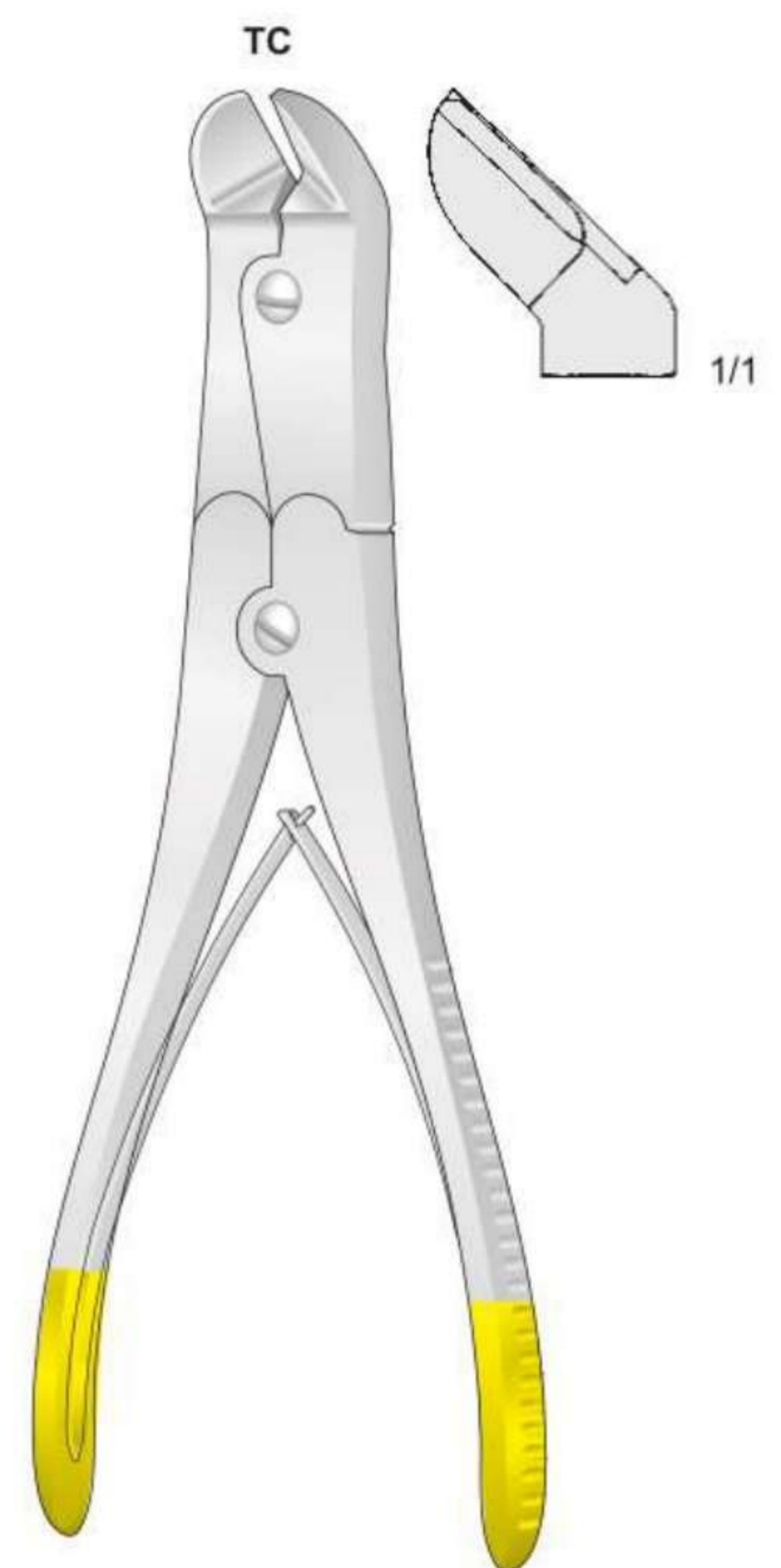

LX-105
230 mm

Für weichen Draht Ø 7 mm
 Für harten Draht Ø 6 mm
 For soft wire Ø 7 mm
 For hard wire Ø 6 mm
 Per filo leggero Ø 7 mm
 Per filo duro Ø 6 mm
 Para alambres ligero Ø 7 mm
 Para alambres duro Ø 6 mm
 Pour fil léger Ø 7 mm
 Pour fil dur Ø 6 mm

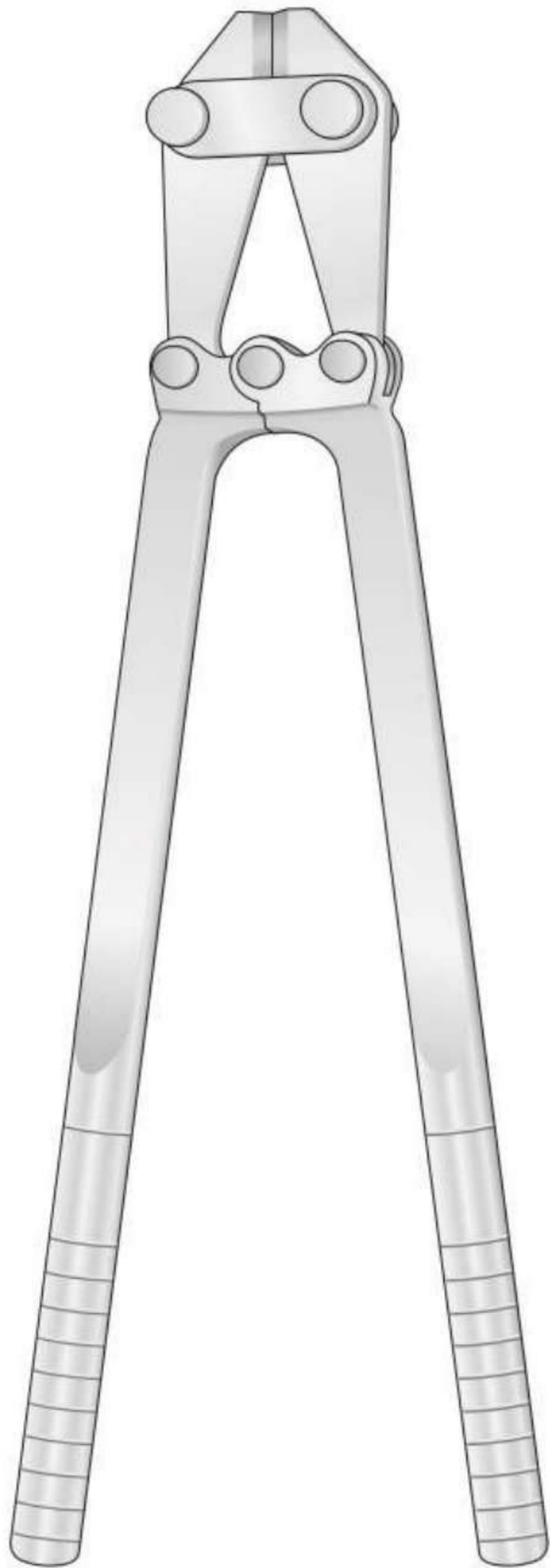

VF-98
480 mm

Für weichen Draht Ø 7 mm
 Für harten Draht Ø 6 mm
 For soft wire Ø 7 mm
 For hard wire Ø 6 mm
 Per filo leggero Ø 7 mm
 Per filo duro Ø 6 mm
 Para alambres ligero Ø 7 mm
 Para alambres duro Ø 6 mm
 Pour fil léger Ø 7 mm
 Pour fil dur Ø 6 mm

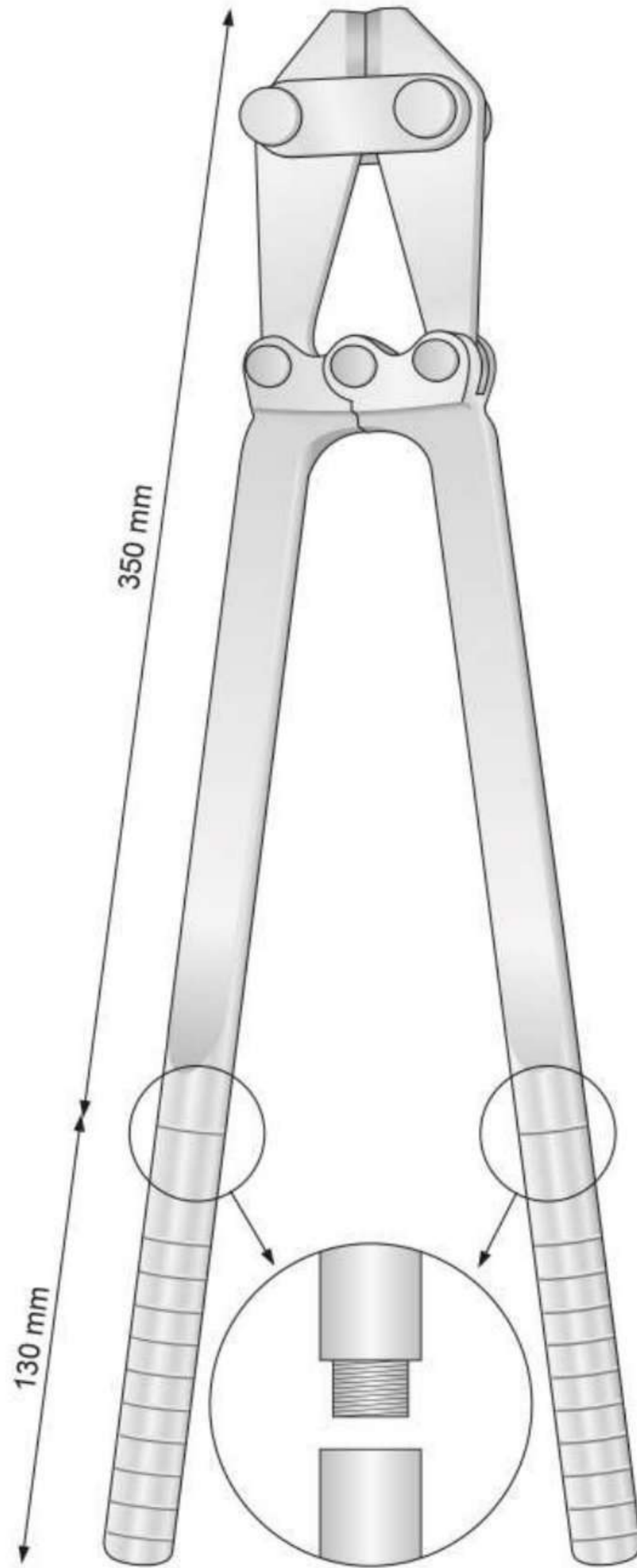

VF-98M
480 mm

Für weichen Draht Ø 5 mm
 Für harten Draht Ø 4,5 mm
 For soft wire Ø 5 mm
 For hard wire Ø 4,5 mm
 Per filo leggero Ø 5 mm
 Per filo duro Ø 4,5 mm
 Para alambres ligero Ø 5 mm
 Para alambres duro Ø 4,5 mm
 Pour fil léger Ø 5 mm
 Pour fil dur Ø 4,5 mm

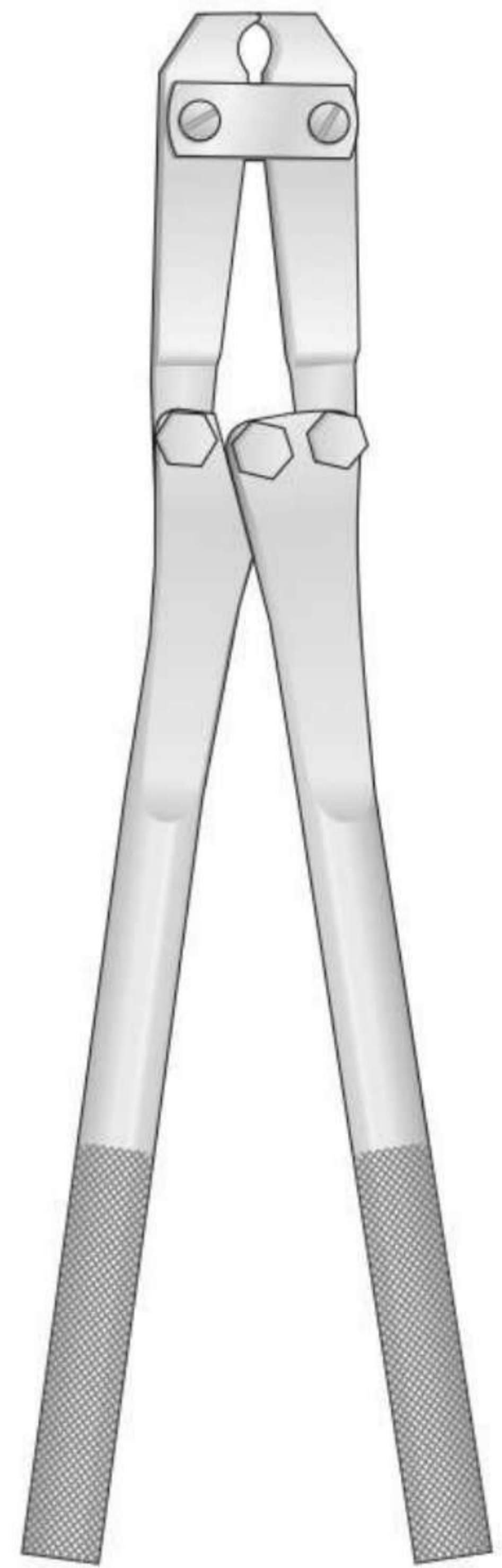

LX-107
375 mm

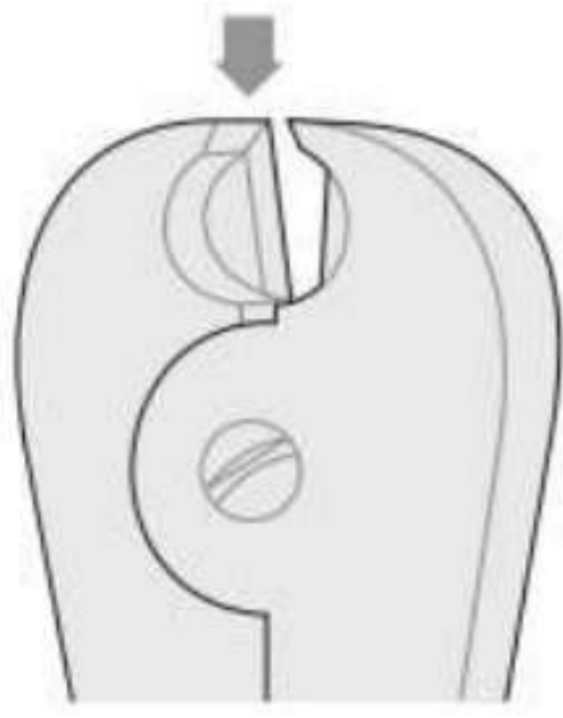

Für weiche Drähte bis Ø 2 mm
Per fili morbidi fino a Ø 2 mm
Pour fils mous jusqu'à Ø 2 mm

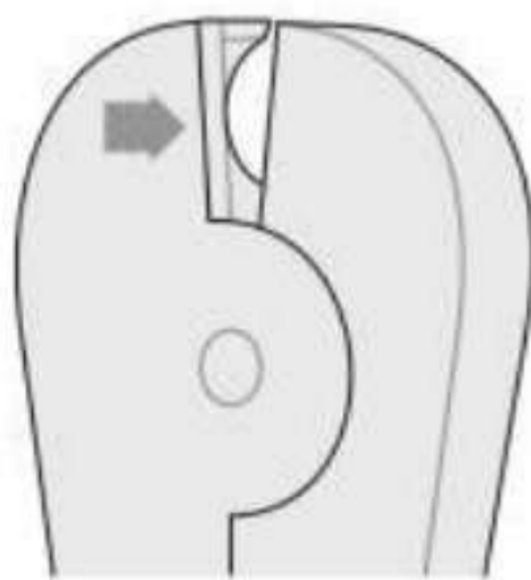

Für harte Drähte bis Ø 1,5 mm
Per fili duri fino a Ø 1,5 mm
Pour fils durs jusqu'à Ø 1,5 mm

TC



LX-126
180 mm

Von Kirschner-Drähten Ø 6 mm
For Kirschner wires Ø 6 mm
Per chiodi Kirschner Ø 6 mm

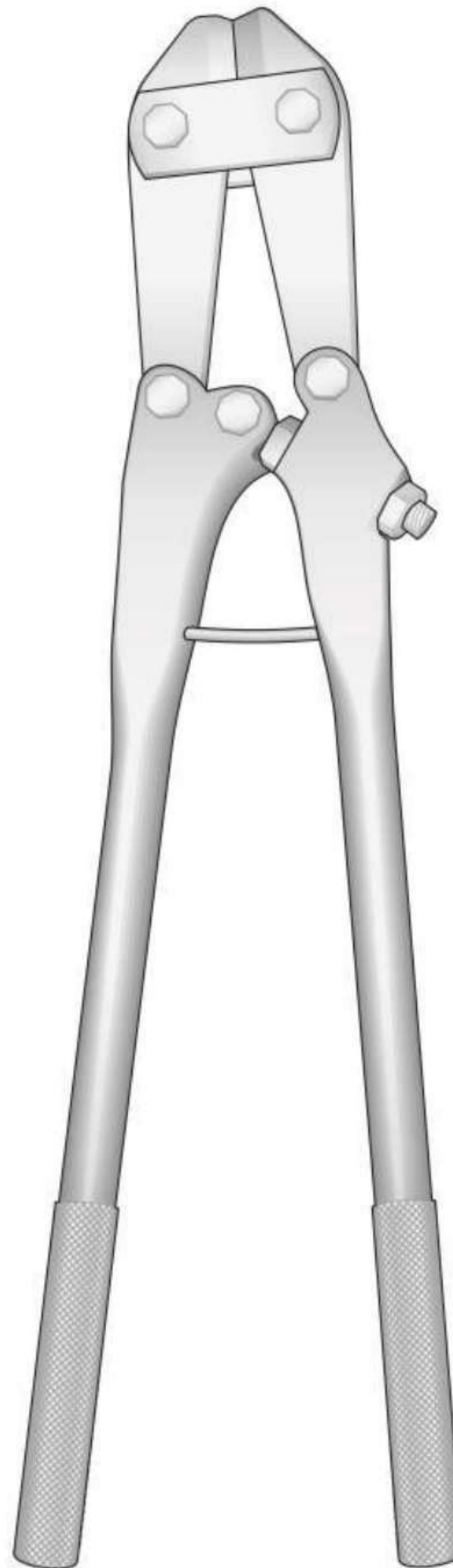

LX-150
450 mm

Von Kirschner-Drähten Ø 6 mm
For Kirschner wires Ø 6 mm
Per chiodi Kirschner Ø 6 mm

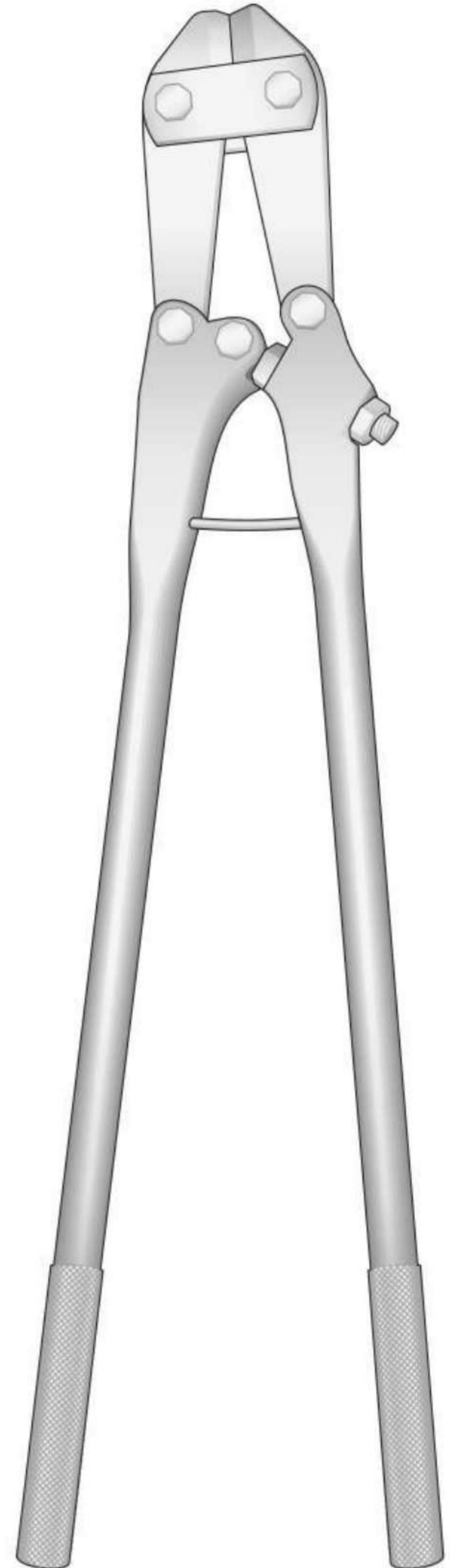

LX-151
560 mm

Gipsspreizer
Gipsabreisszangen

Plaster spreader
Plaster cast breakers

Strumenti
per gesso

Pinza para
arrancar vendajes

Pinces pour
appareils plâtrés

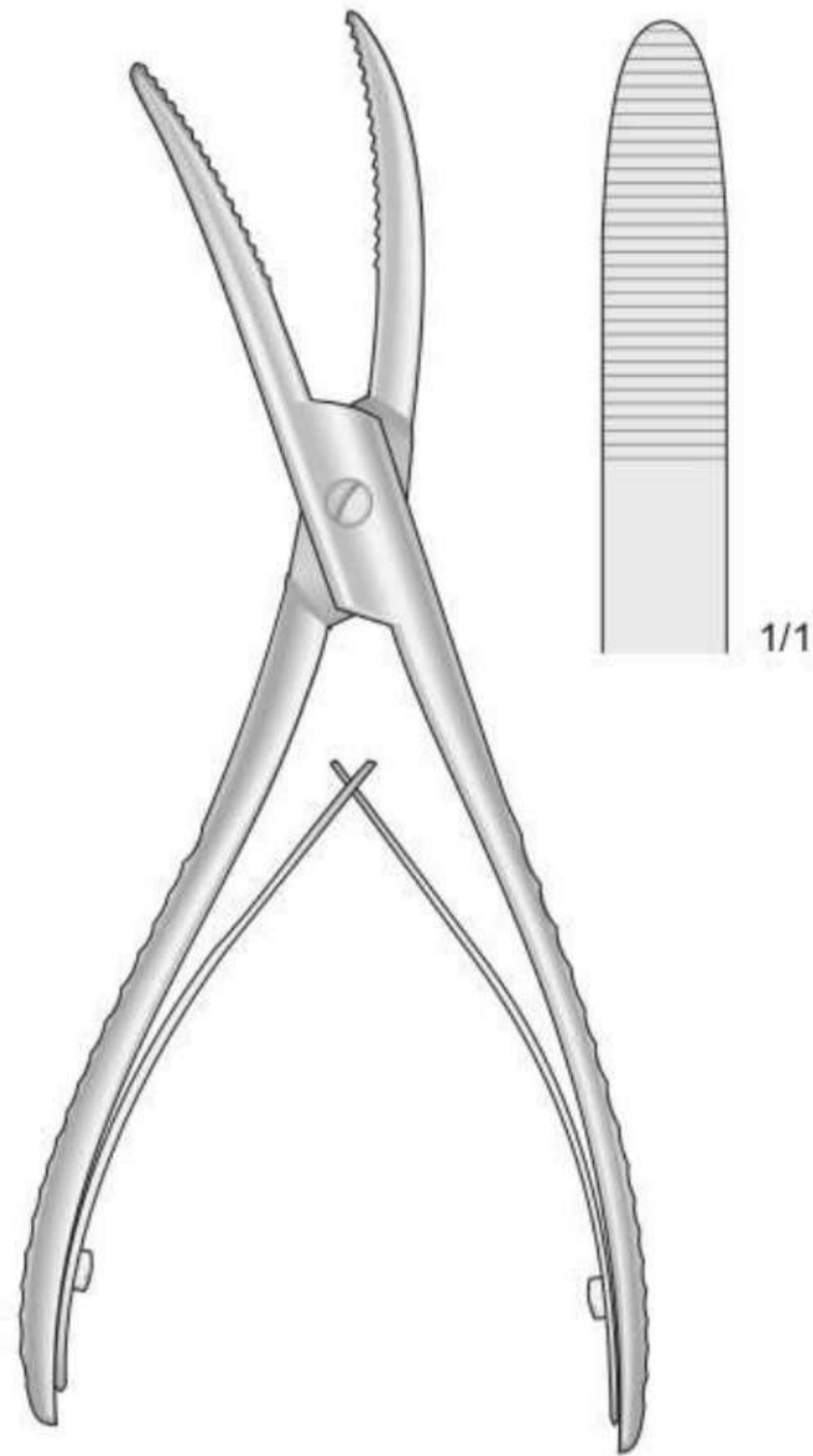

WOLFF
LX-113
180 mm

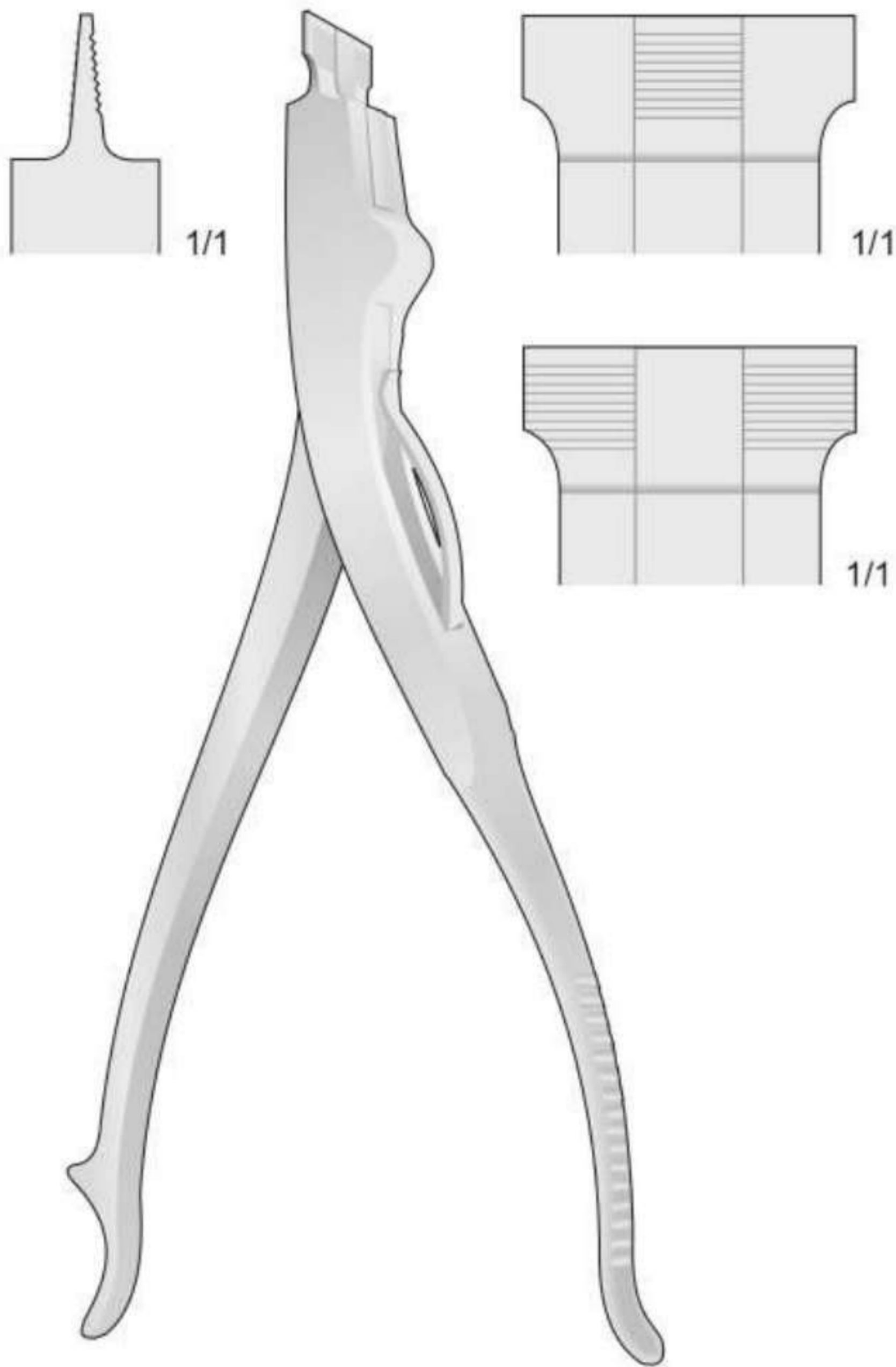

LX-115
220 mm

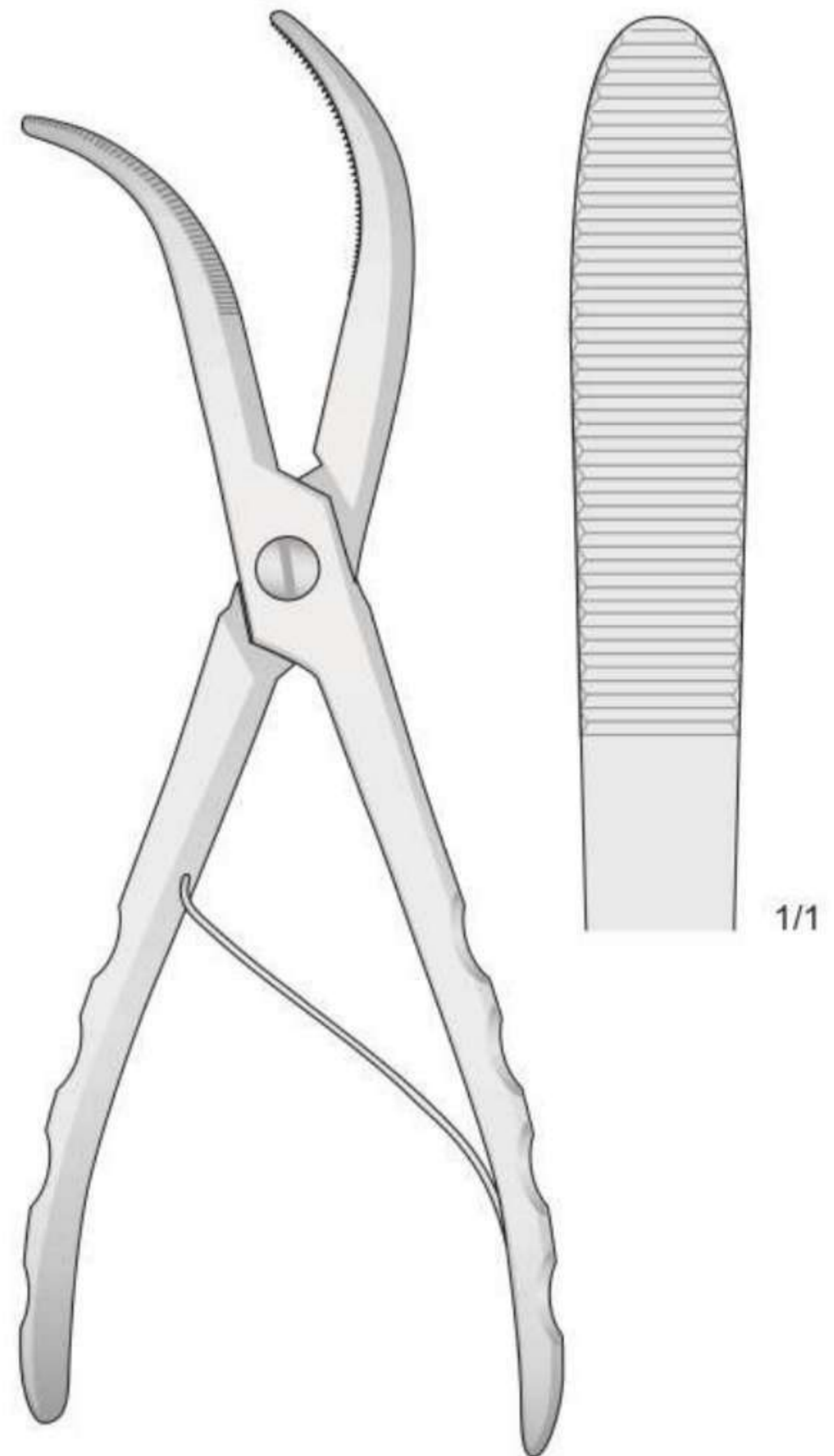

WOLFF
LX-114
250 mm

Gipsspreizer
Gipsabreisszangen

Plaster spreader
Plaster cast breakers

Strumenti
per gesso

Pinza para
arrancar vendajes

Pinces pour
appareils plâtrés

Gips - Schneidezangen
Cesoie per gesso

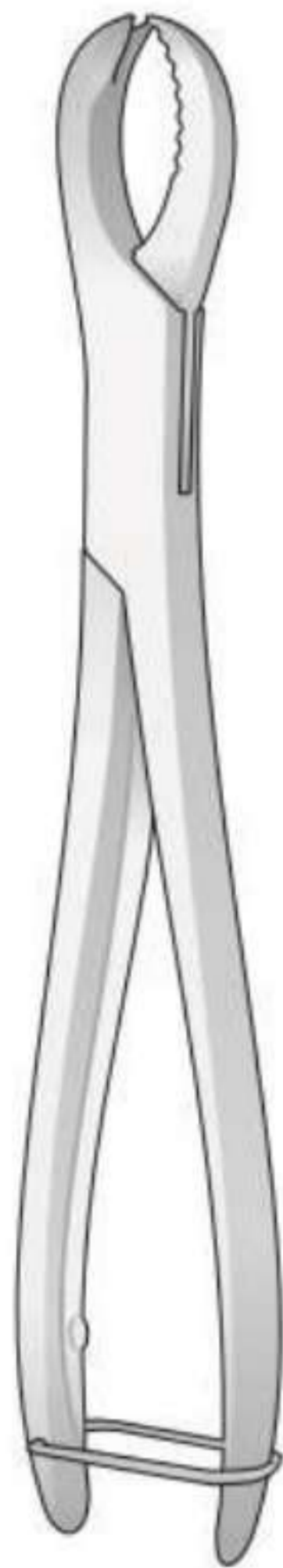

BK-30
210 mm

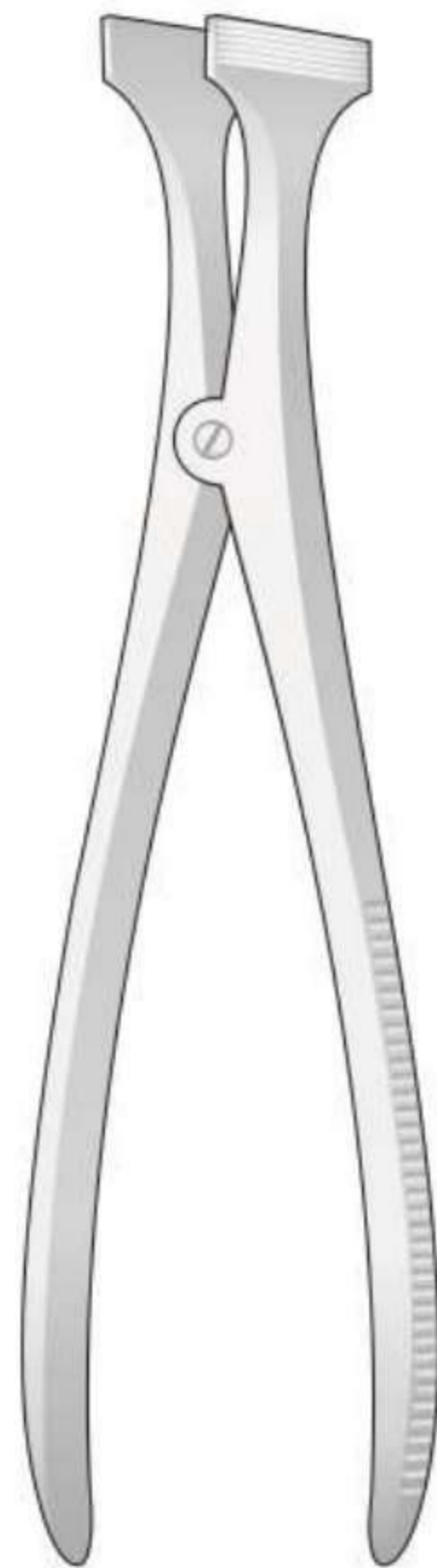

**HENNIG
LX-123**
270 mm

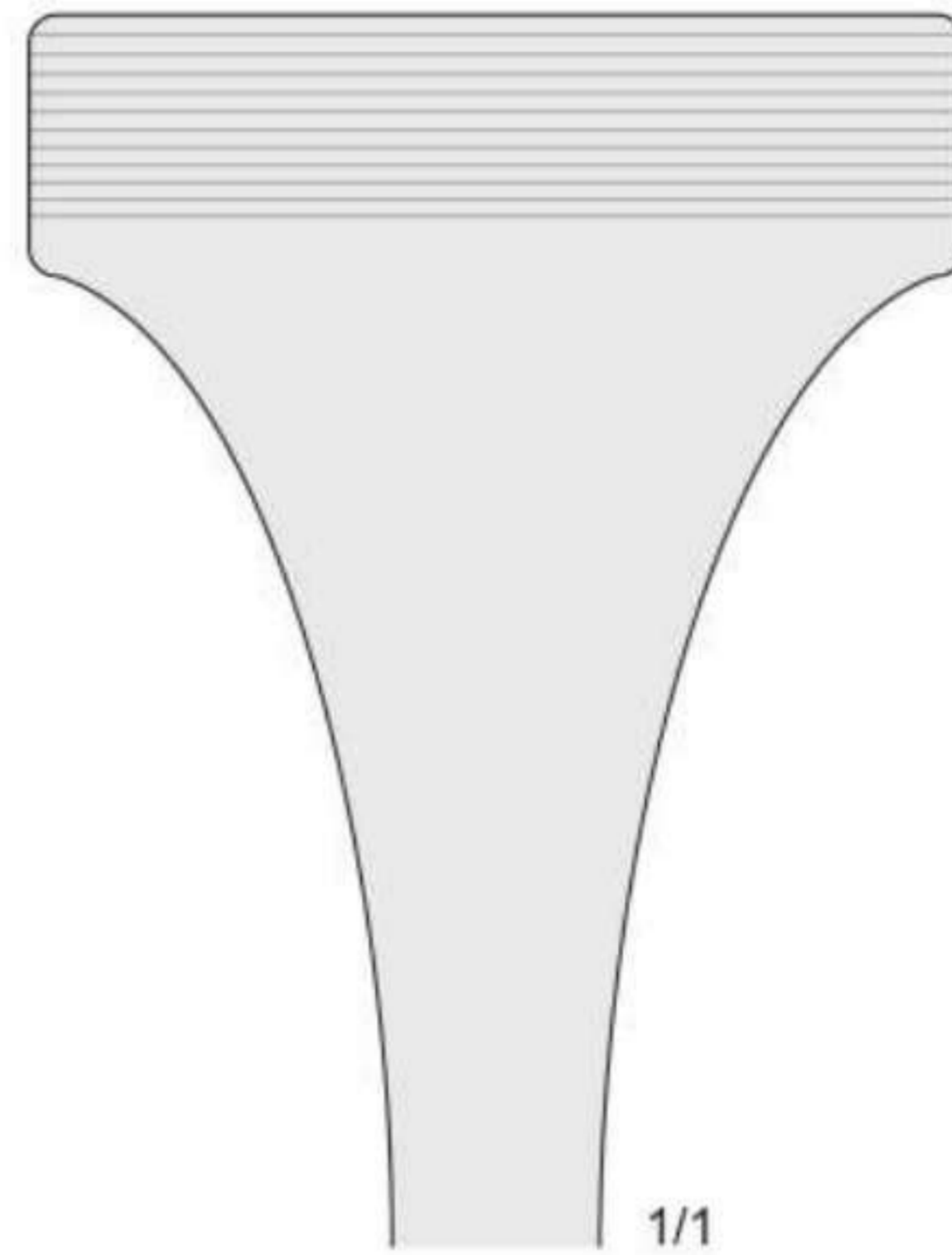

1/1

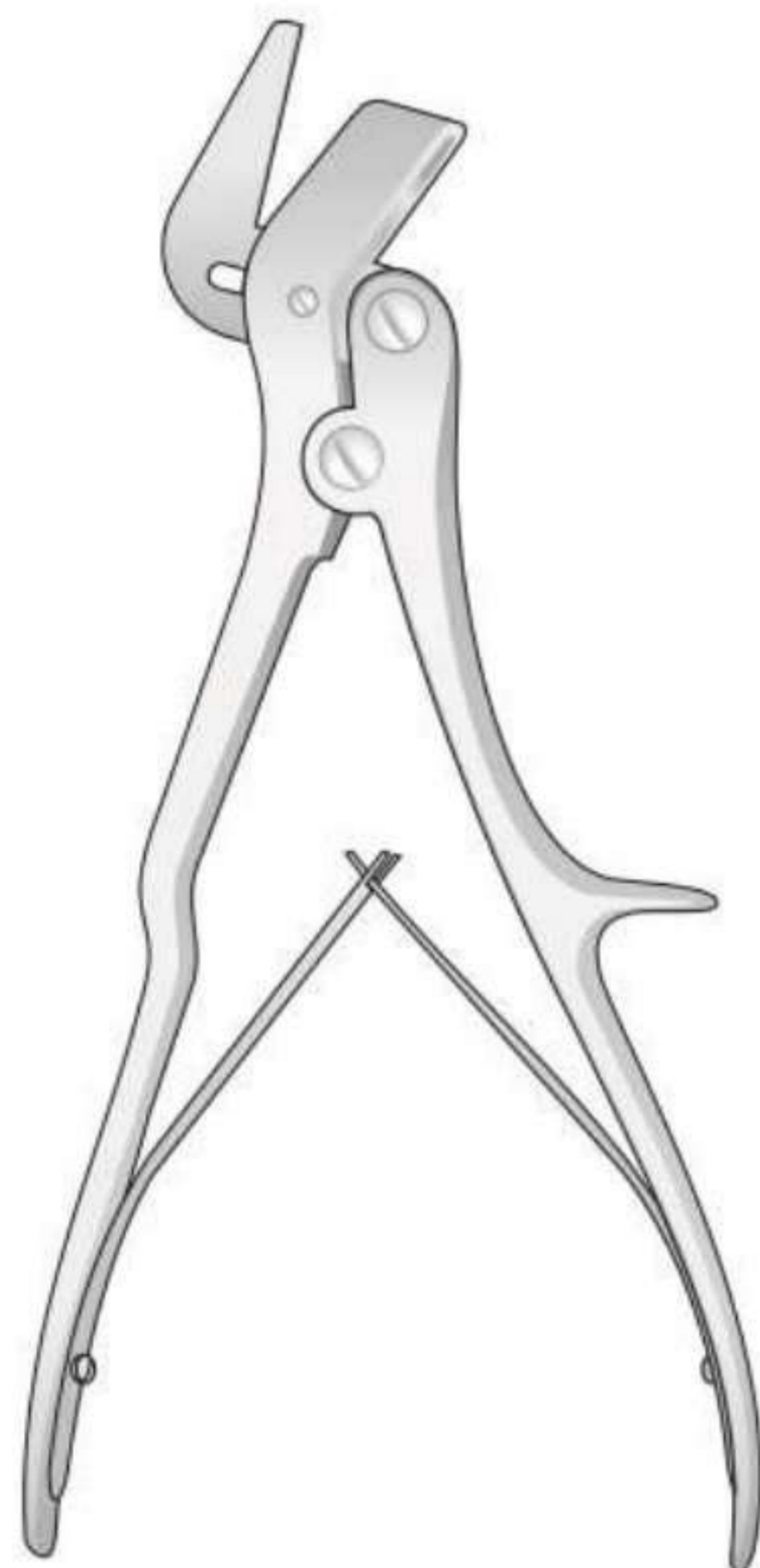

**STILLE
LX-120**
230 mm

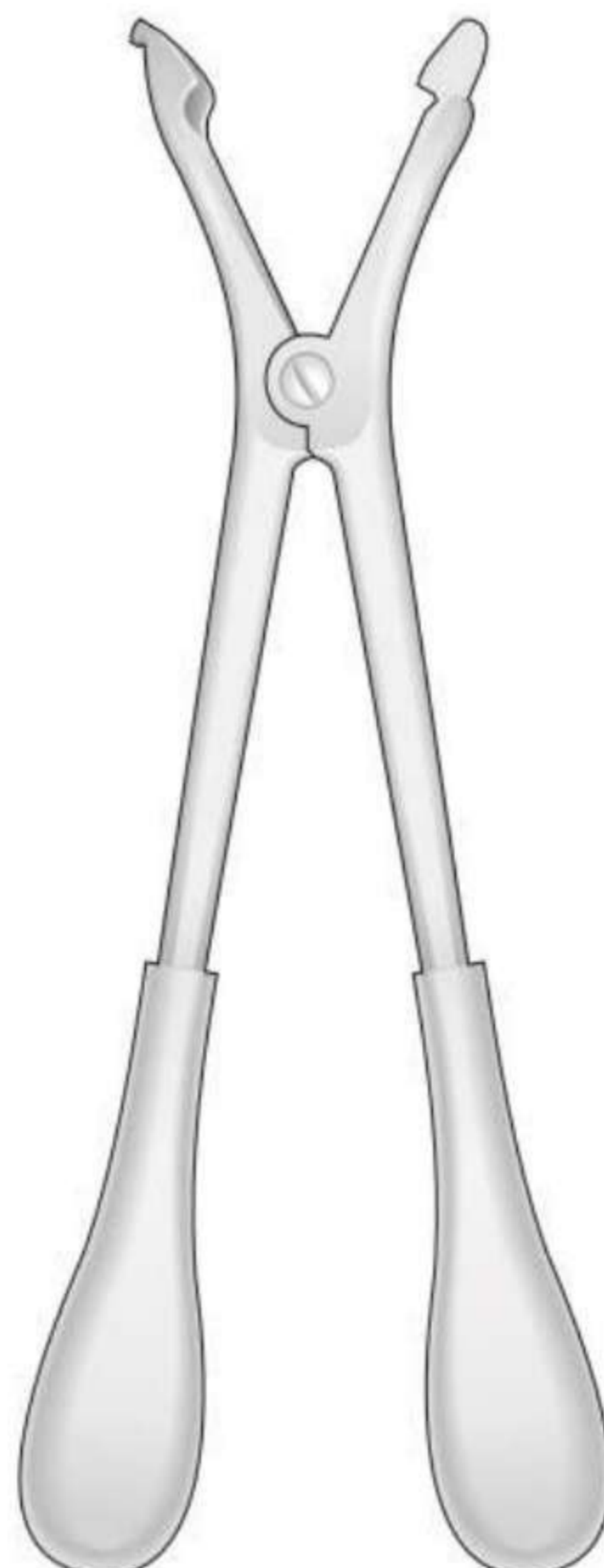

**HAGLUND
LX-121**
280 mm

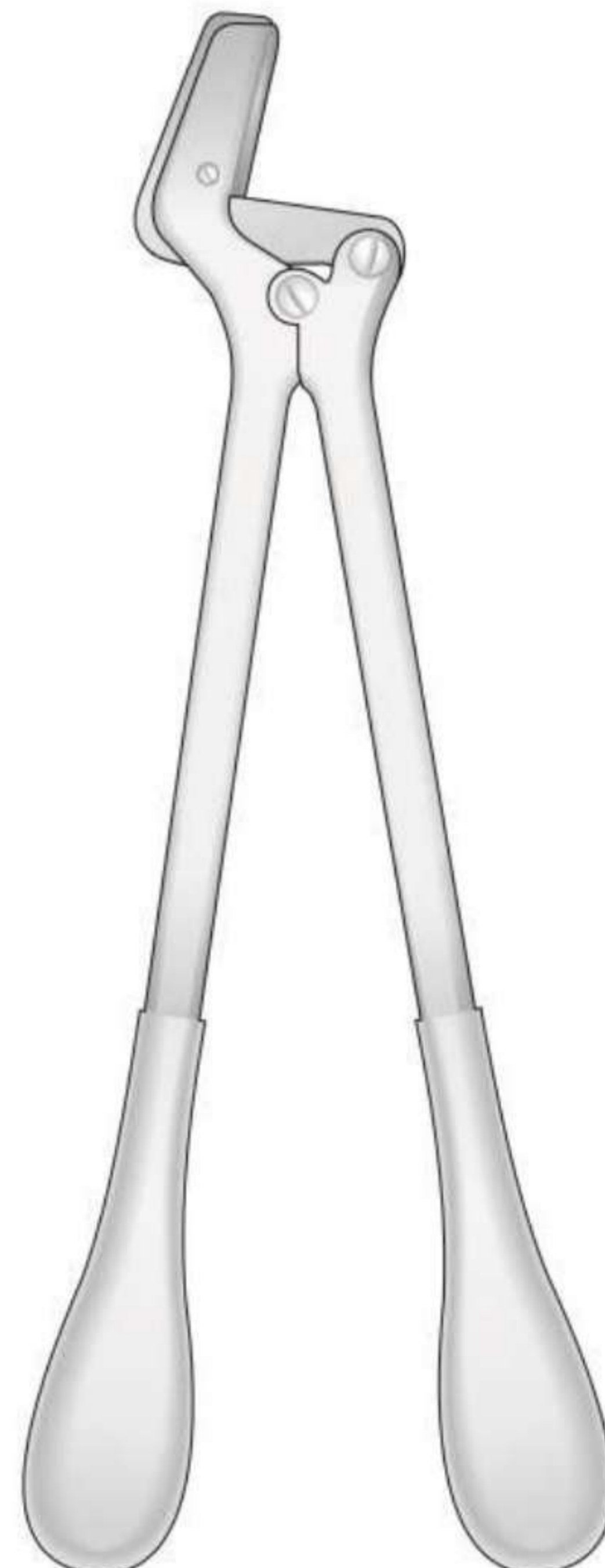

**STILLE
LX-122**
370 mm



TRS INSTRUMENTS

TRAUMATOLOGY AND ORTHOPAEDICS

Retractors
Retraktoren
Écarteurs
Separadores
Divaricatori

Nervhaken
Nerve Hooks
Crochets à nerfs
Ganchos para nervios
Uncini per nervi

Micro Dissectors
Mikro-Dissektoren
Micro Dissecteurs
Micro Discadores
Micro Dissettori

Retraktoren für
Mikrodiskektomie

Retractors for Micro
Lumbar Discectomy

Divaricatori per micro
dissectomia lombare

Separadores para micro
dissectomia lumbar

Écarteurs pour micro
dissectomie lombaire

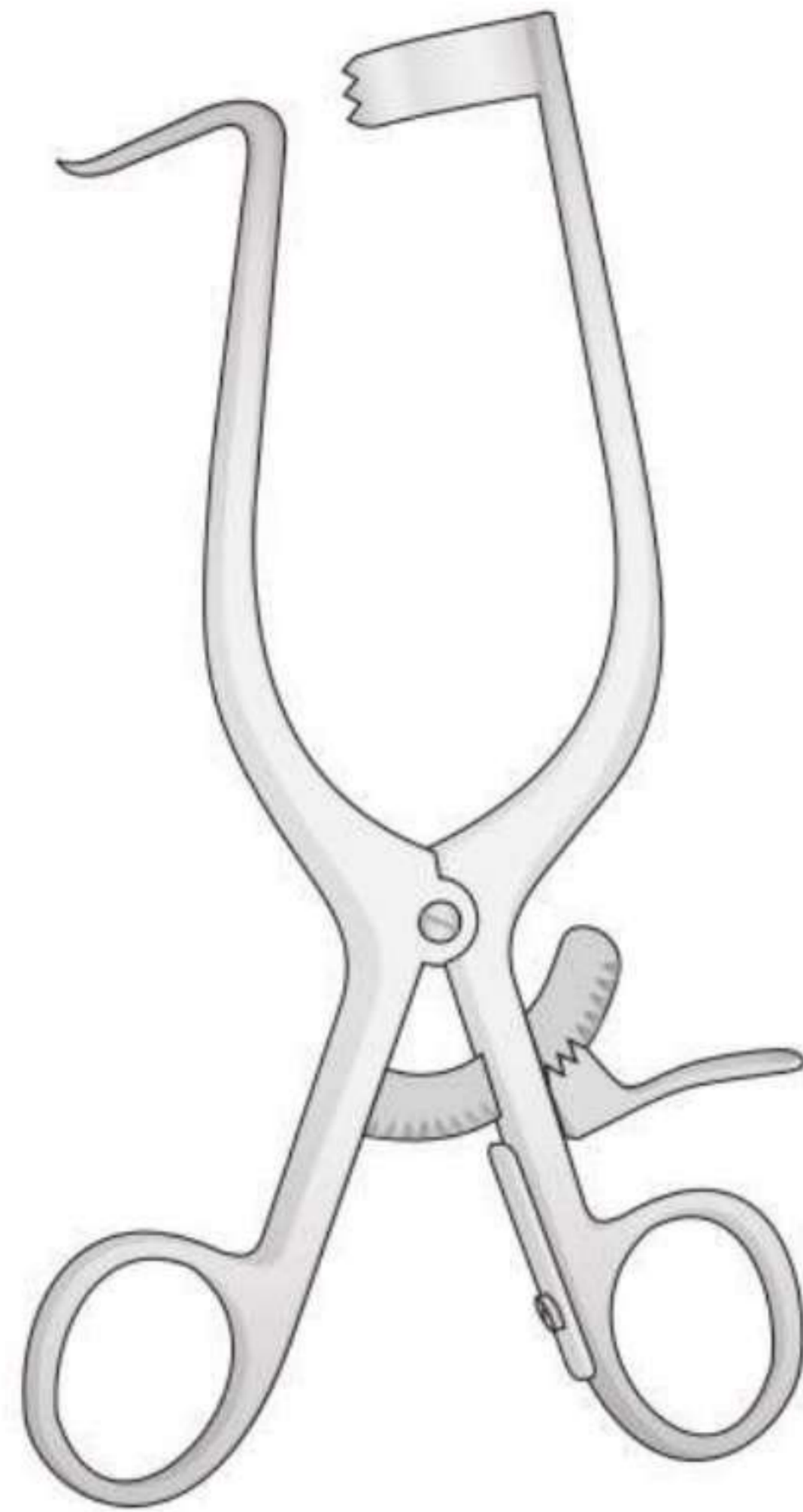

WILLIAMS
BV-401/BV-403
170 mm

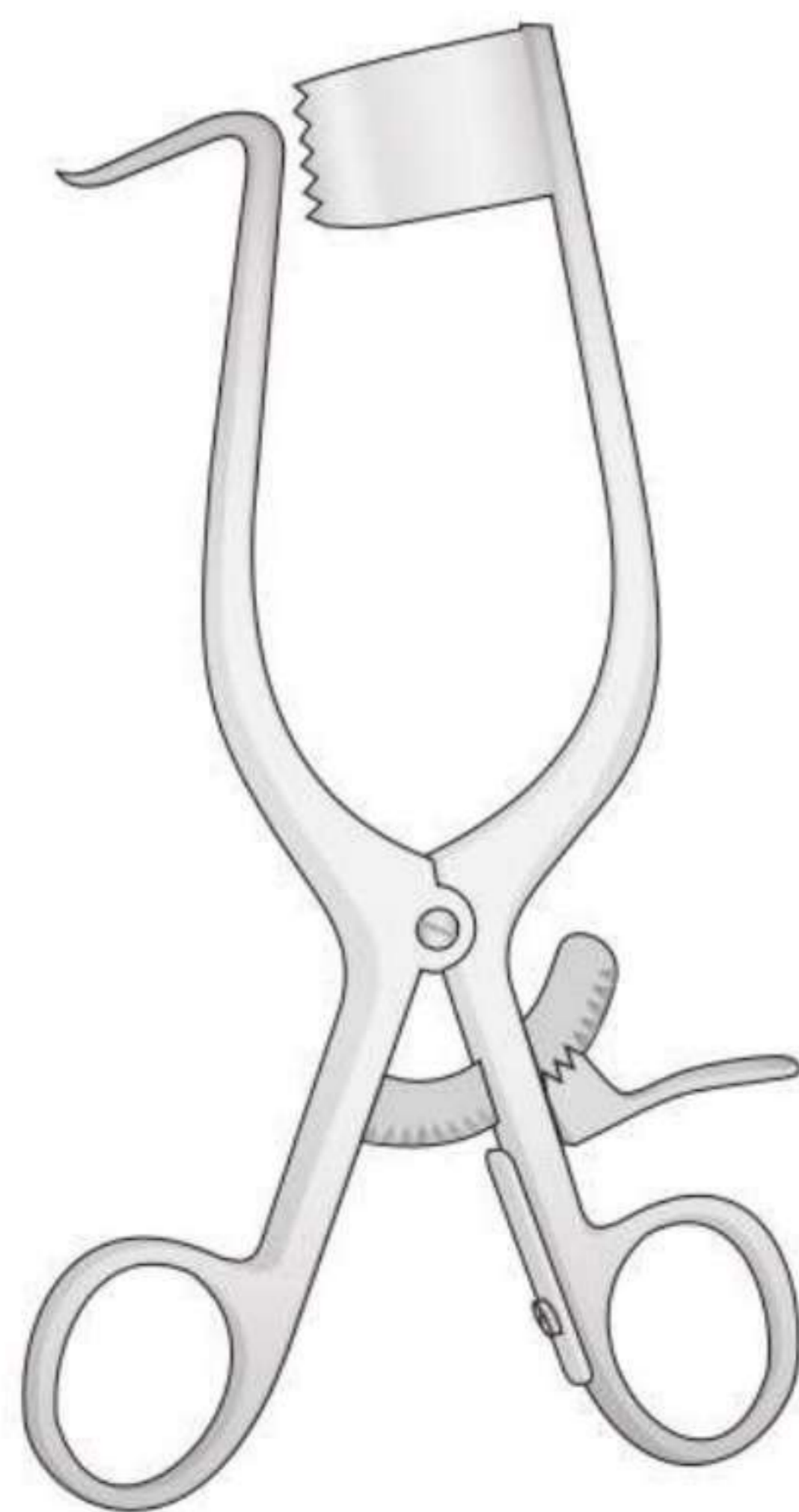

WILLIAMS
BV-404/BV-406
170 mm

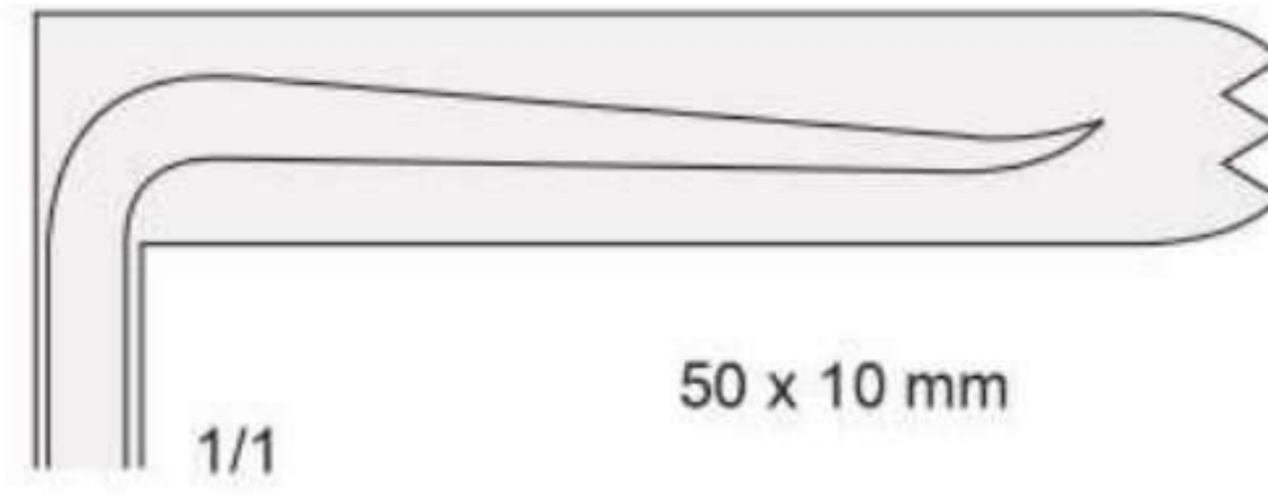

BV-401

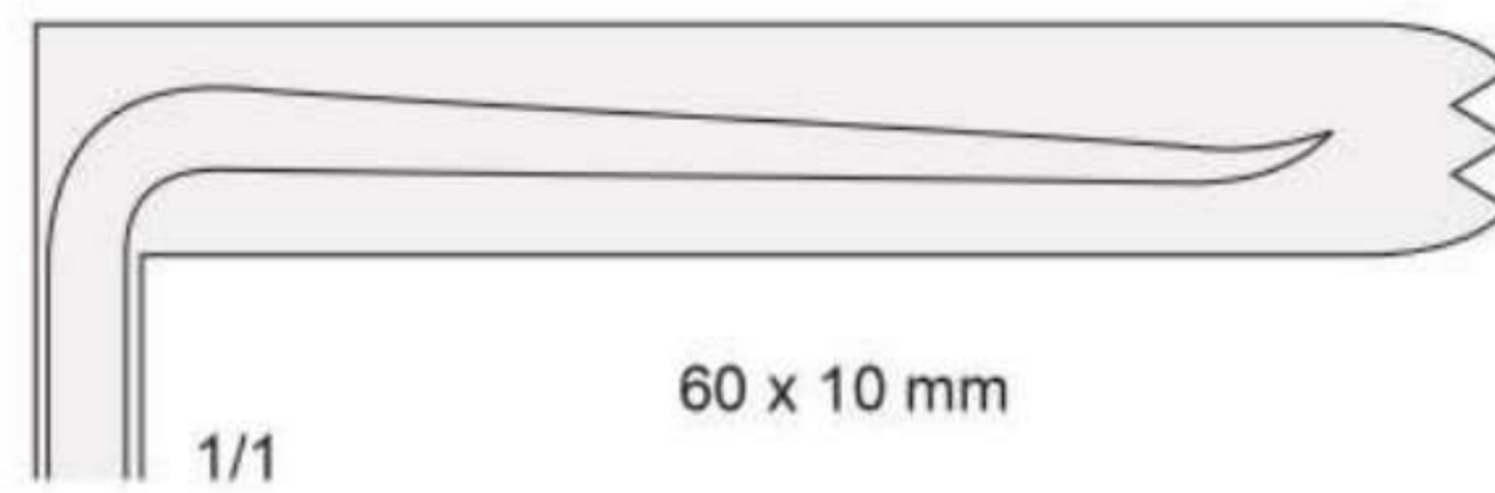

BV-402

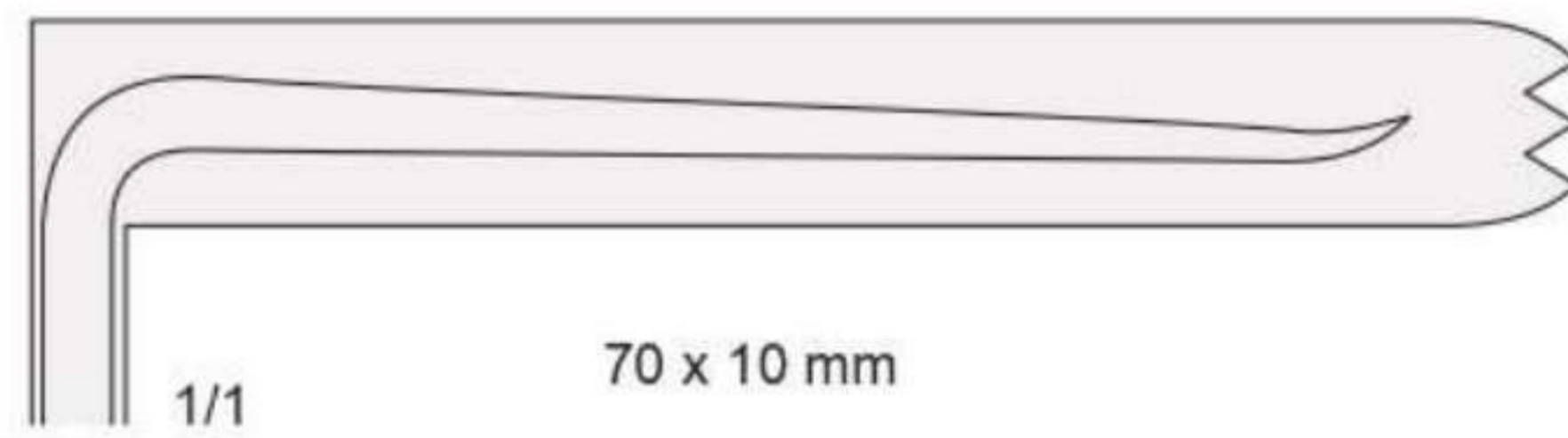

BV-403

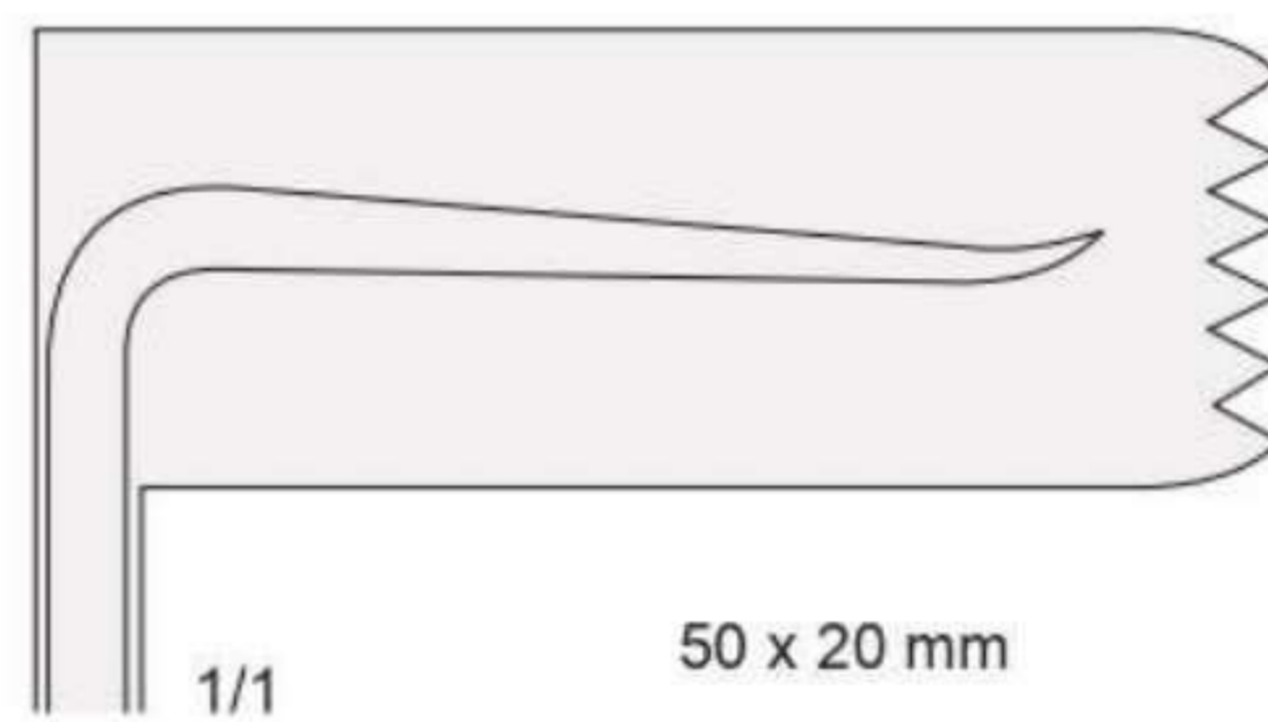

BV-404

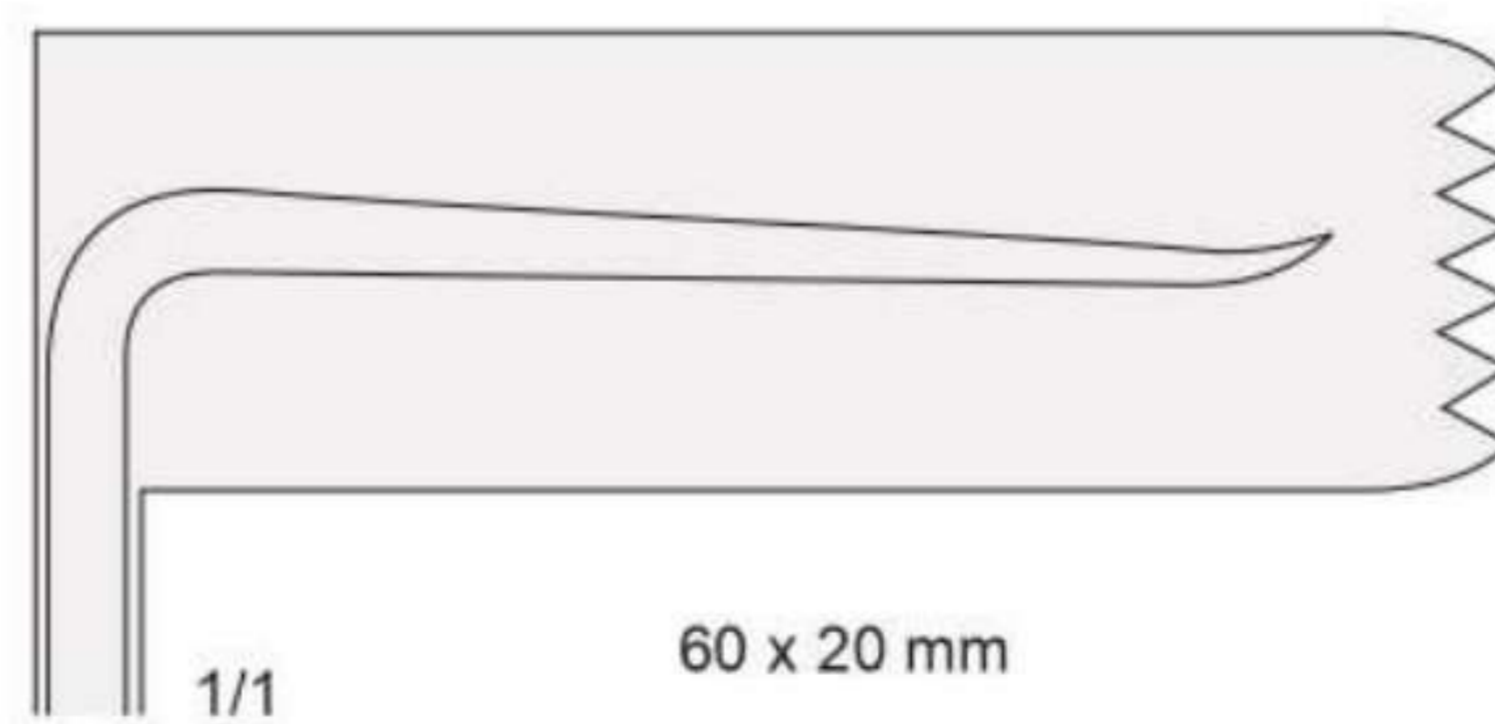

BV-405

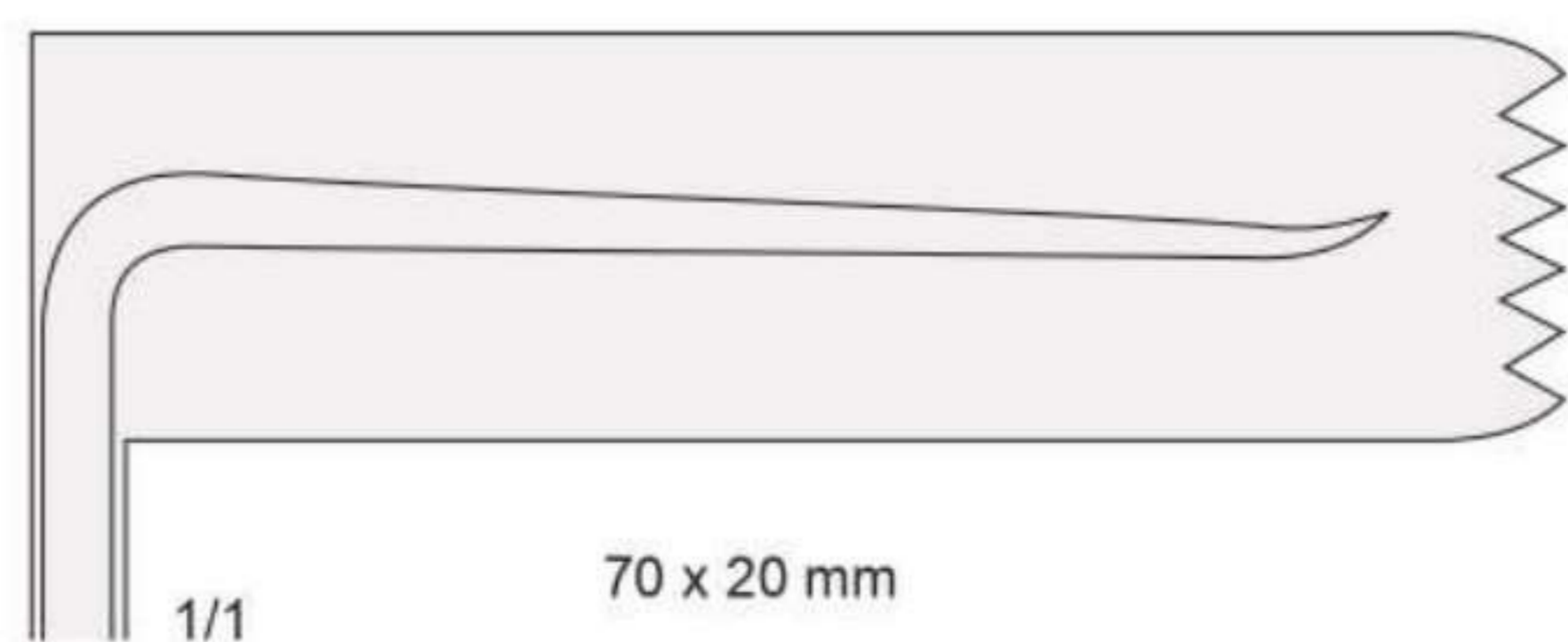

BV-406

Spitz - Sharp
Acuto - Agudas
Pointu
4 x 4 Zähne
4 x 4 Teeth
4 x 4 Denti
4 x 4 Dientes
4 x 4 Dents

Halbscharf - Sharp
Semi acuto - Agudas
Semi pointu
4 x 4 Zähne
4 x 4 Teeth
4 x 4 Denti
4 x 4 Dientes
4 x 4 Dents

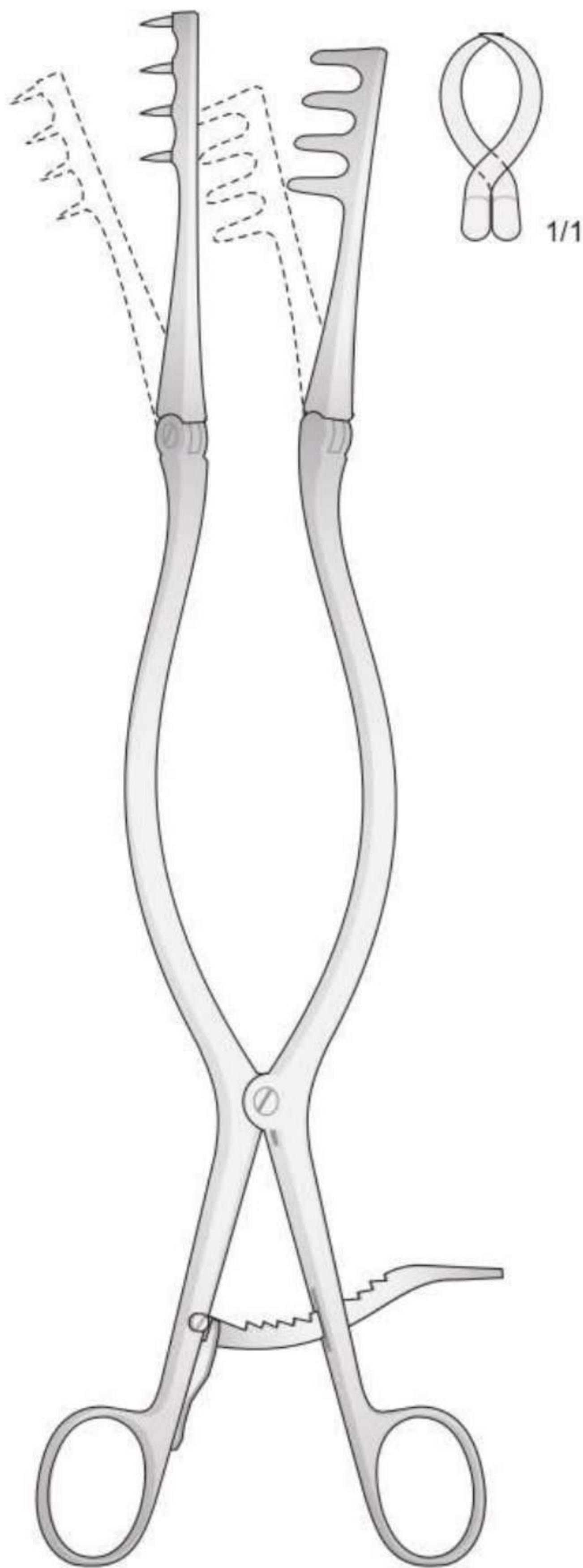

BECKMANN
BV-121
310 mm

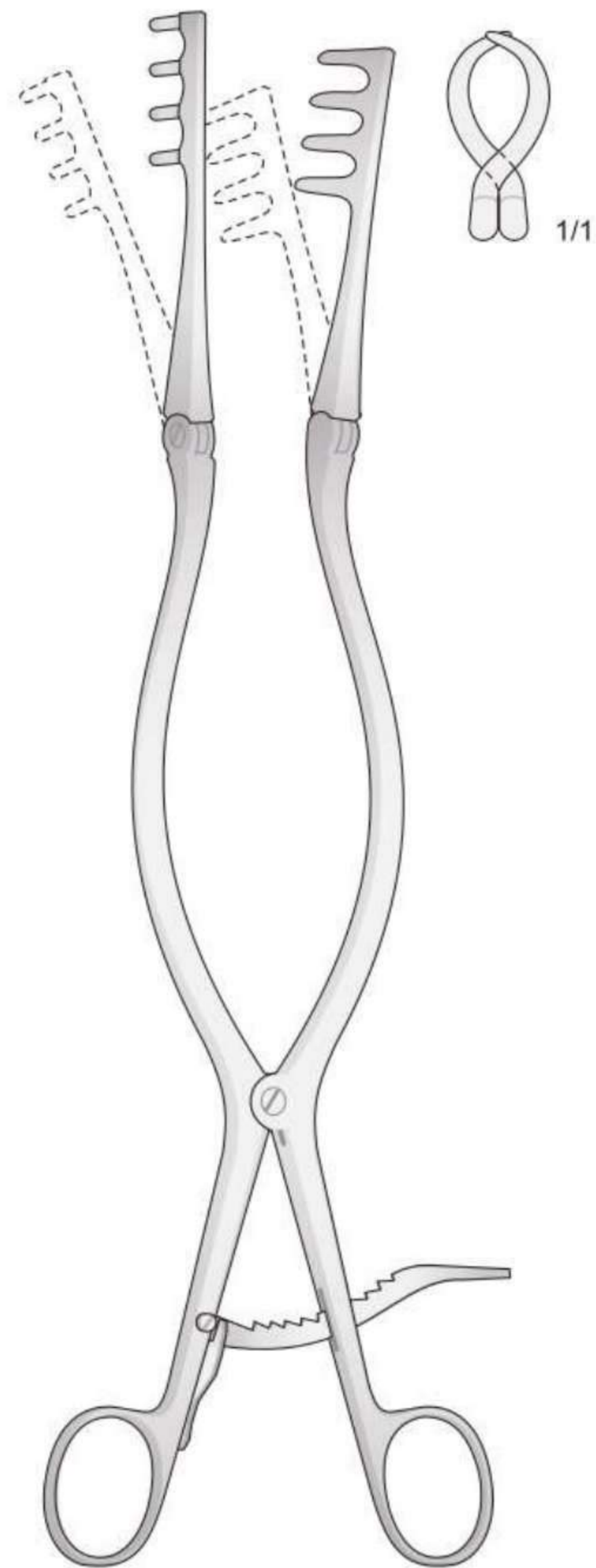

BECKMANN
BV-122
310 mm

Stumpf - Blunt - Smusso
Romas - Mousse

5 x 4 Zähne
5 x 4 Teeth
5 x 4 Denti
5 x 4 Dientes
5 x 4 Dents

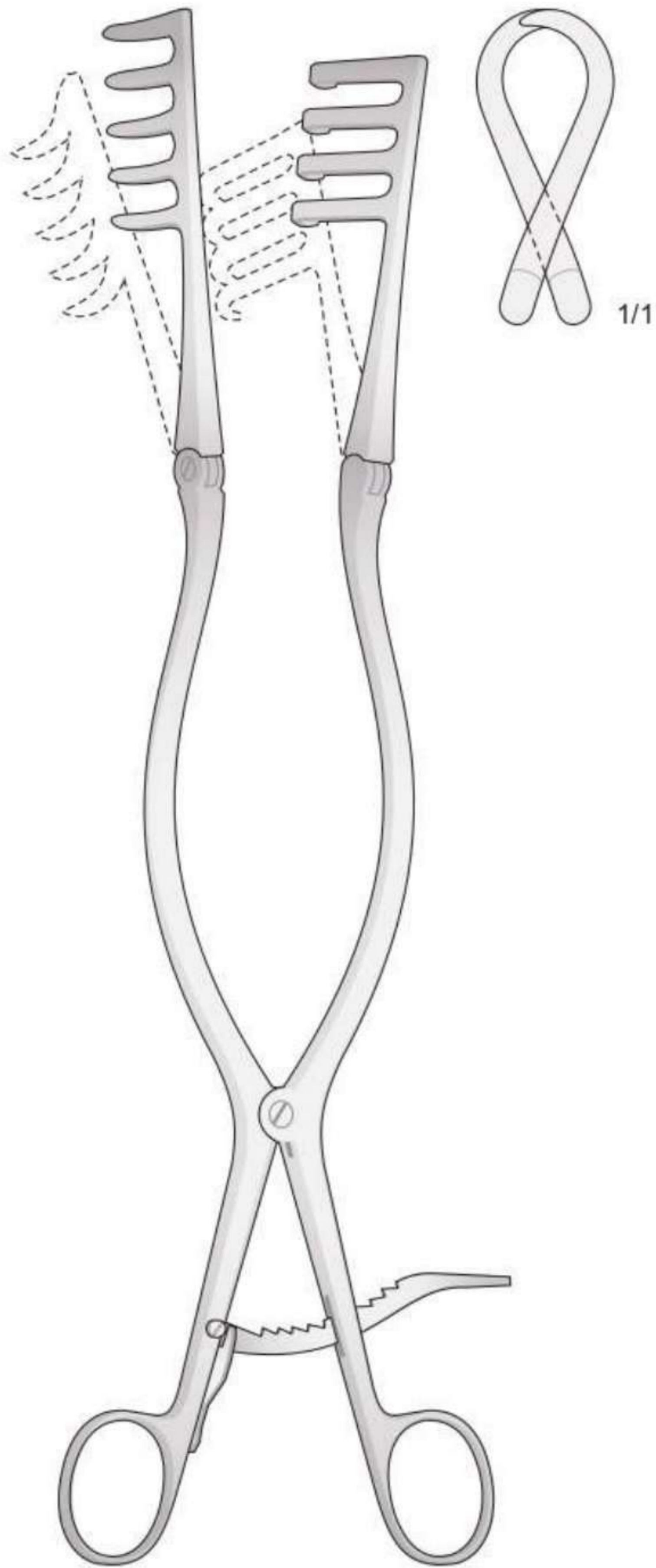

ADSON
BV-123
320 mm

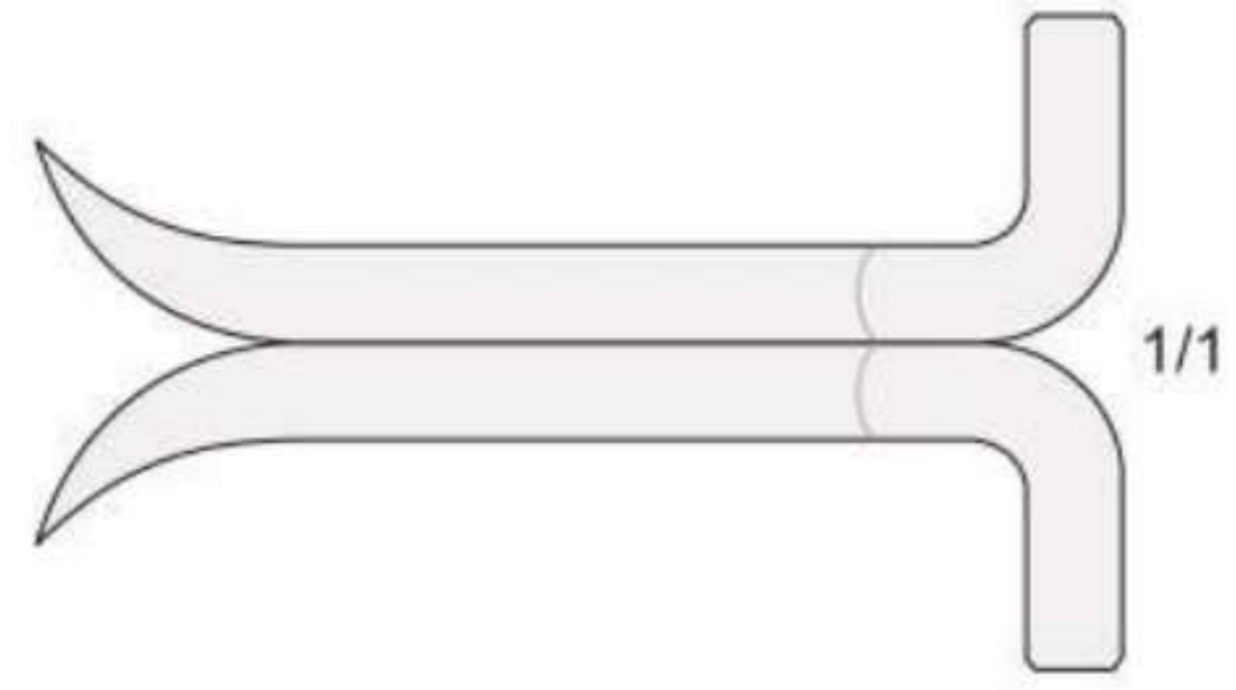

Spitz - Sharp - Acuto
Agudas - Pointù

7 x 7 Zähne
7 x 7 Teeth
7 x 7 Denti
7 x 7 Dientes
7 x 7 Dents

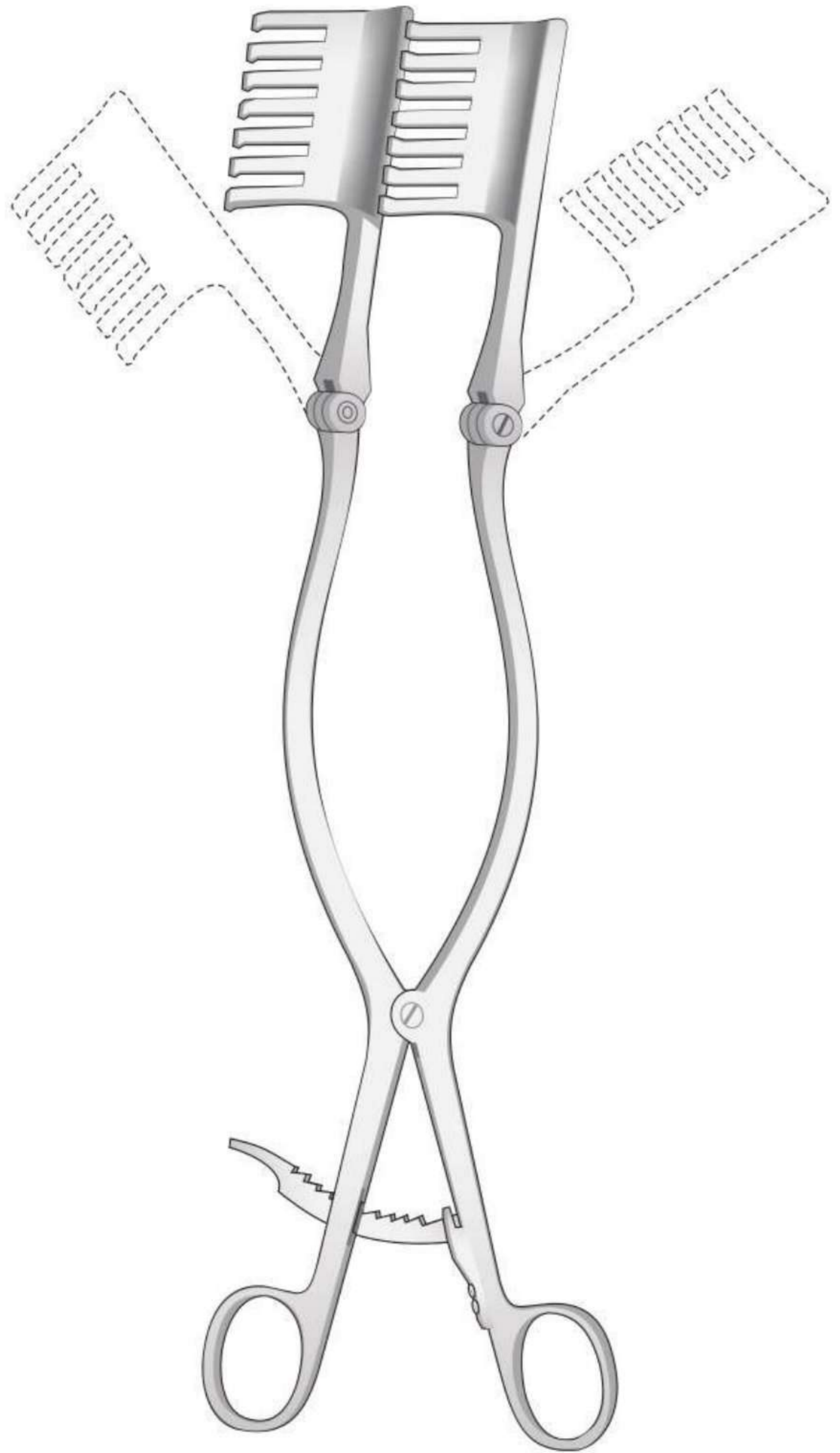

BECKMANN-EATON
BV-124
330 mm

Retraktoren

Retractors

Divaricatori

Separadores

Écarteurs



BV-321

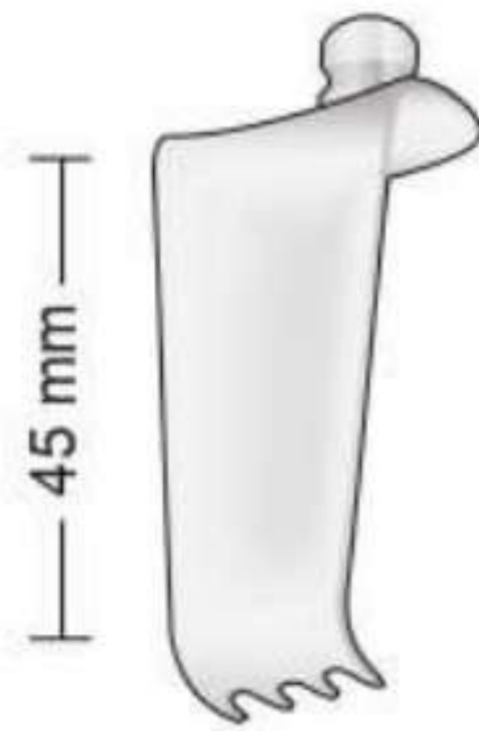

BV-322

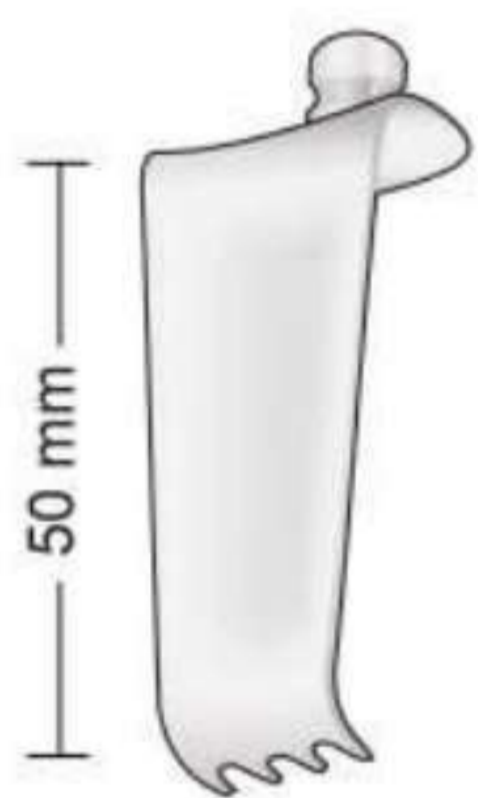

BV-323

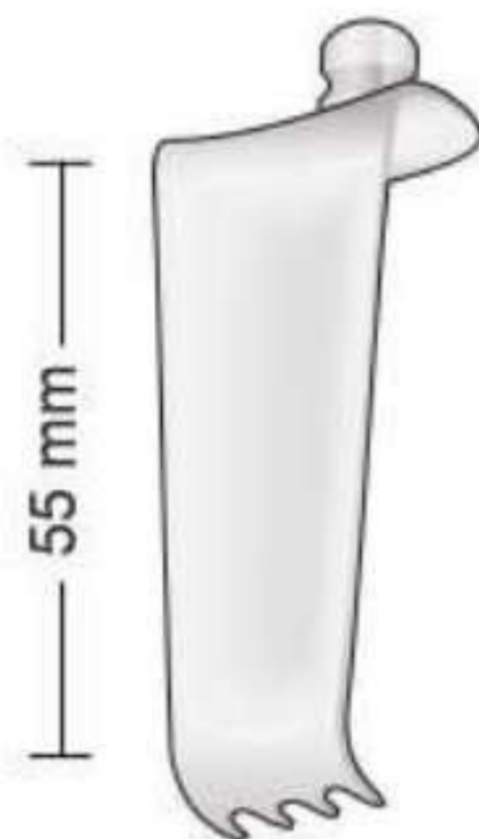

BV-324

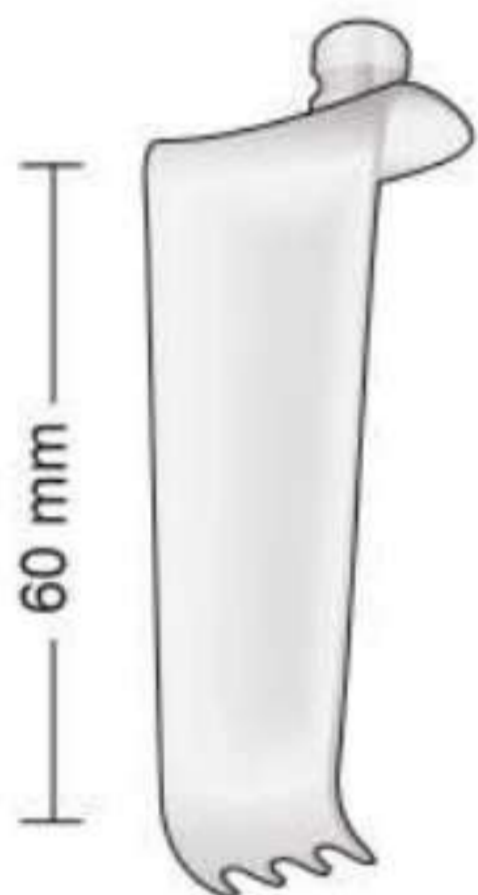

BV-325

CLOWARD Modif.
BV-319
Sperrer, allein
Retractor, only
Divaricatore, solo
Separador, suelto
Ecarteur, seul

CLOWARD modif.
BV-320
Komplett mit 5 Valven
Complete with 5 blades
Completo di 5 valve
Completo con 5 valvas
Complet avec 5 valves

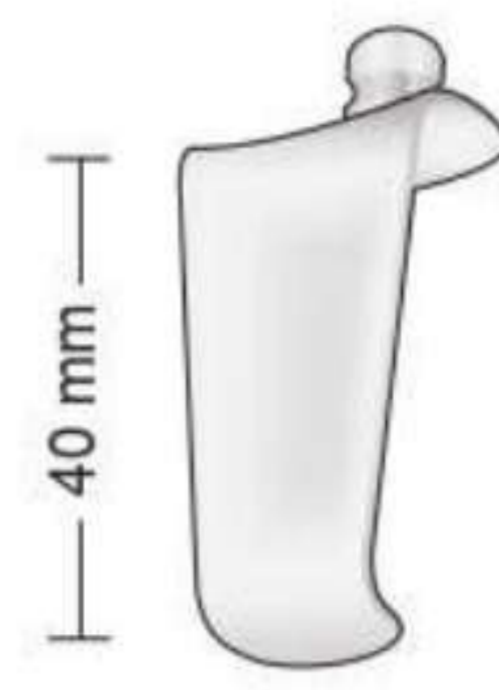

BV-326

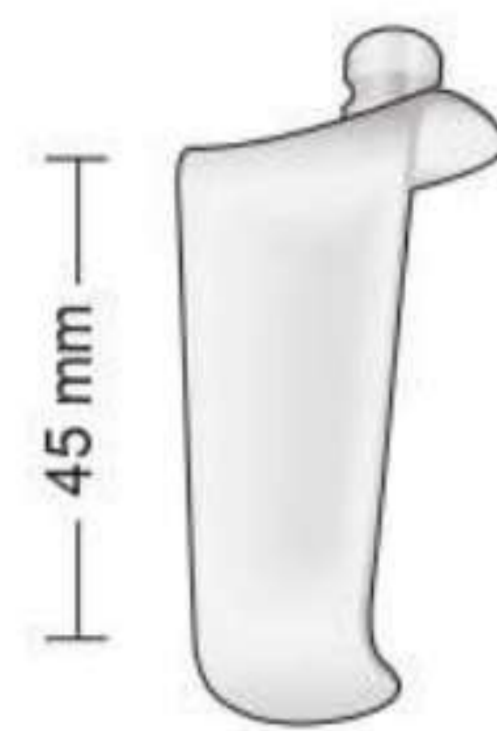

BV-327

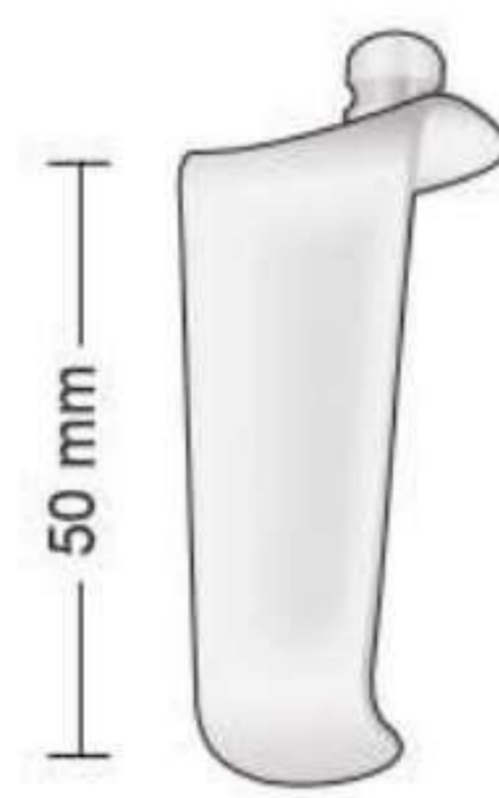

BV-328

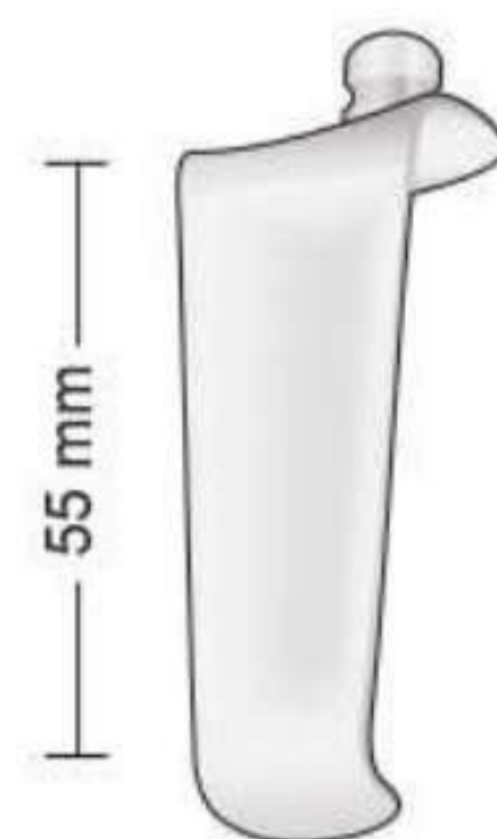

BV-329

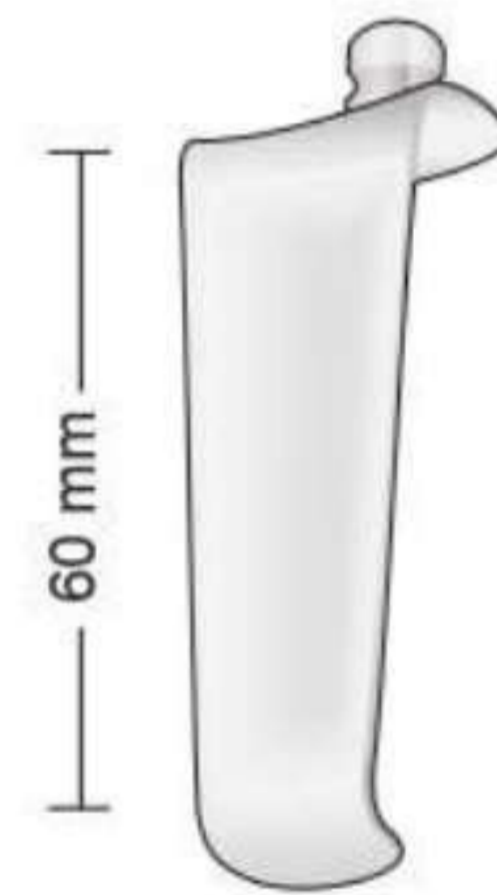

BV-330

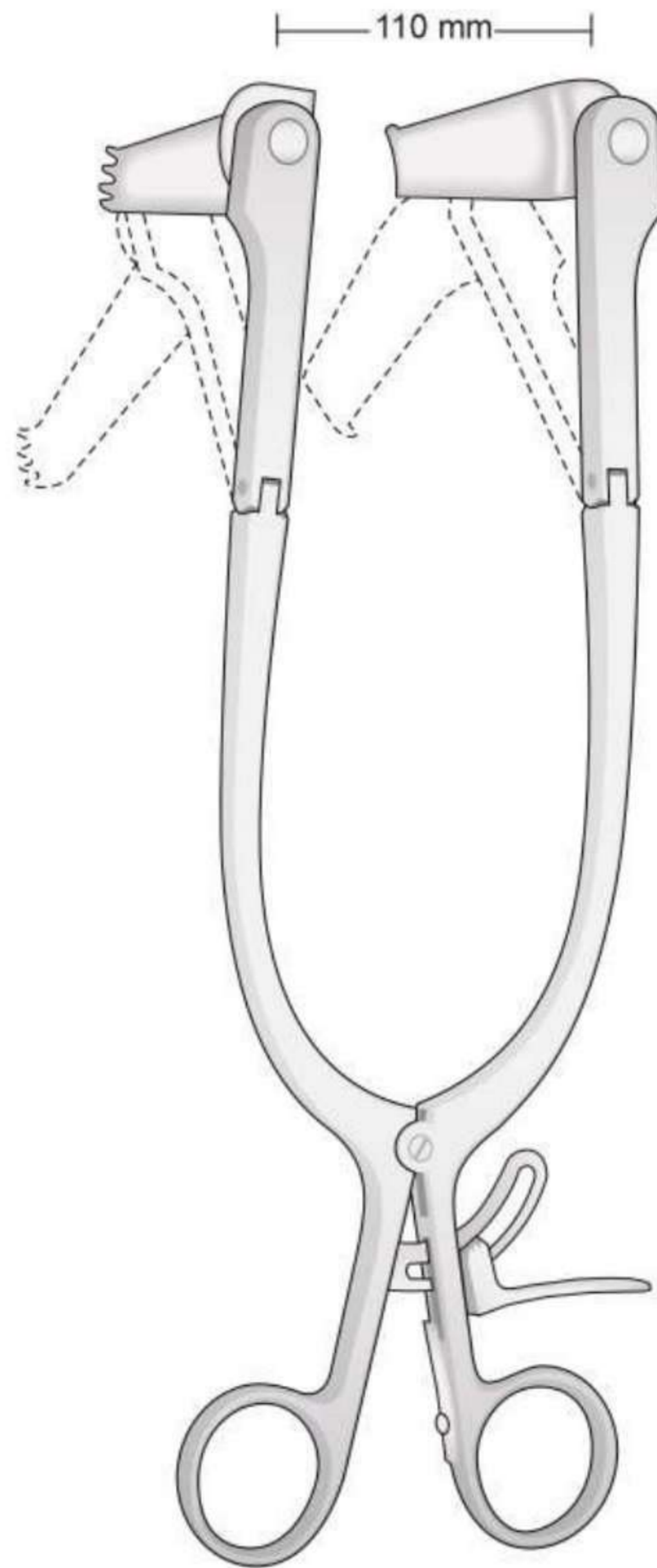

CLOWARD modif.
BV-320
250 mm

für Laminektomie

Retractors
for Laminectomy

Divaricatori
per laminectomia

Separadores
para laminectomía

Écarteurs
pour laminectomie

Instrumente allein, ohne Blätter
Frame only - Strumento solo, senza valve
Cuadro solo - Cadre seul

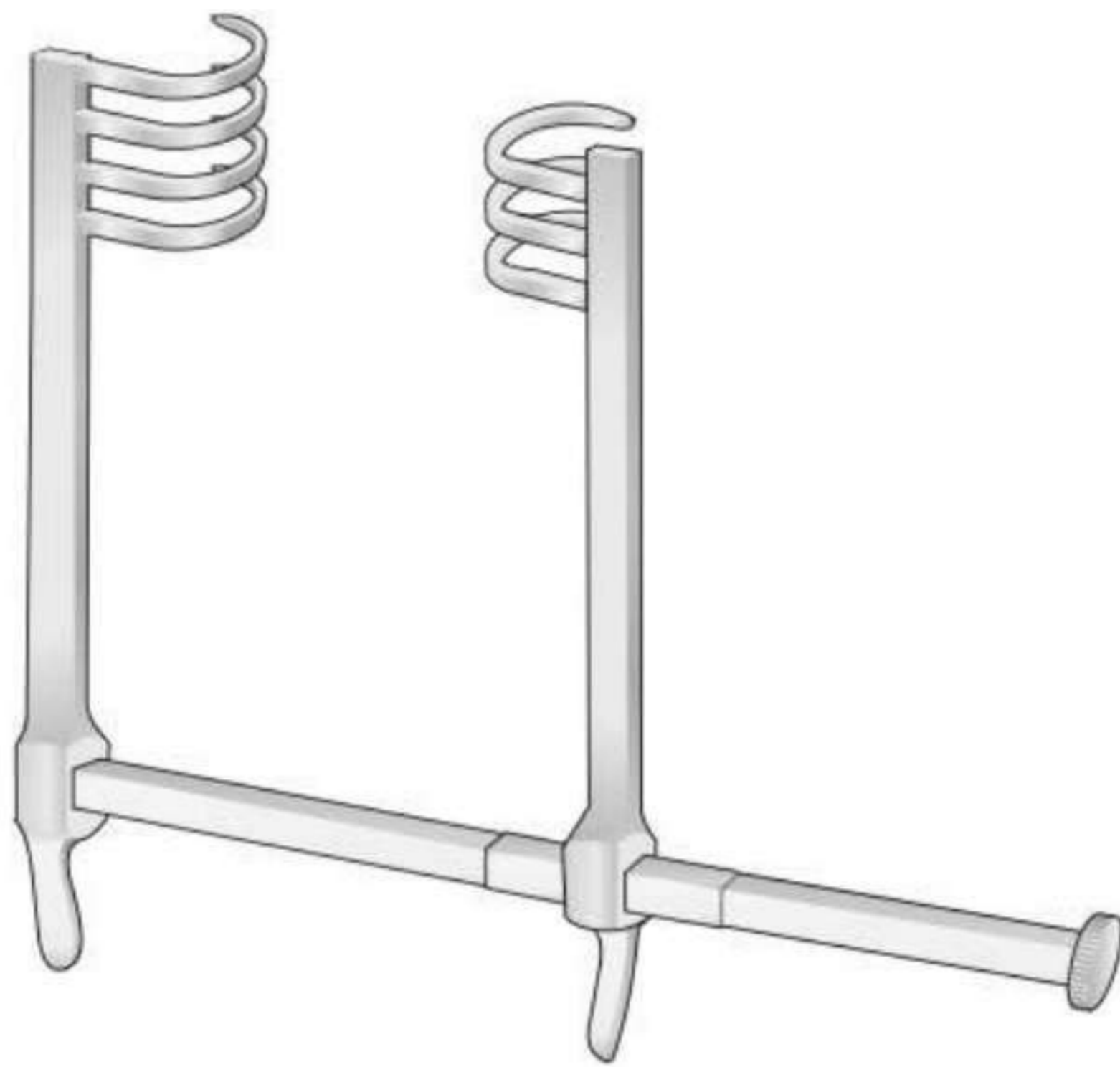

FRAZIER
BV-35

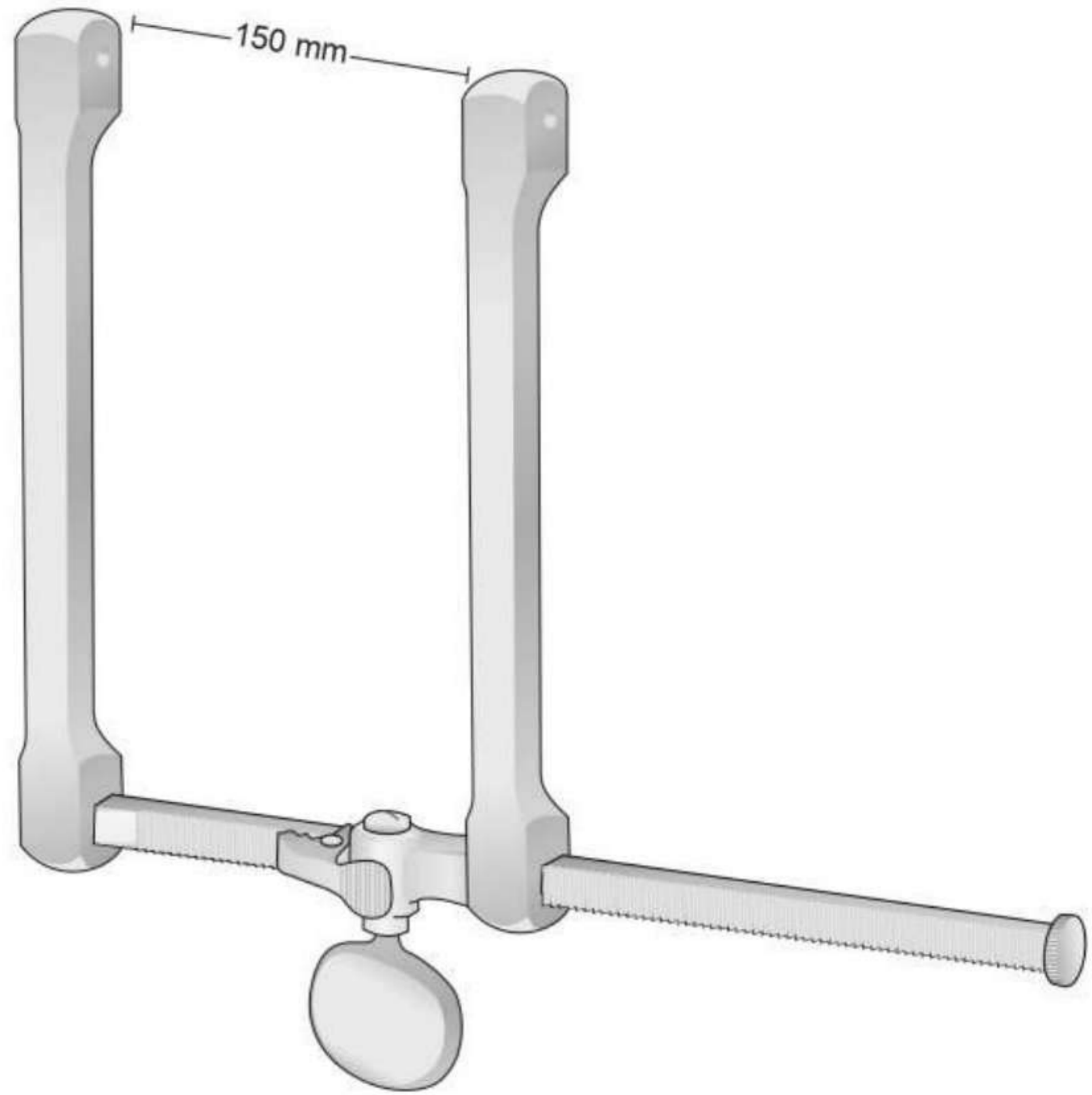

SCOVILLE
BV-161

Instrumente allein, ohne Blätter
Frame only
Strumento solo, senza valve
Cuadro solo
Cadre seul

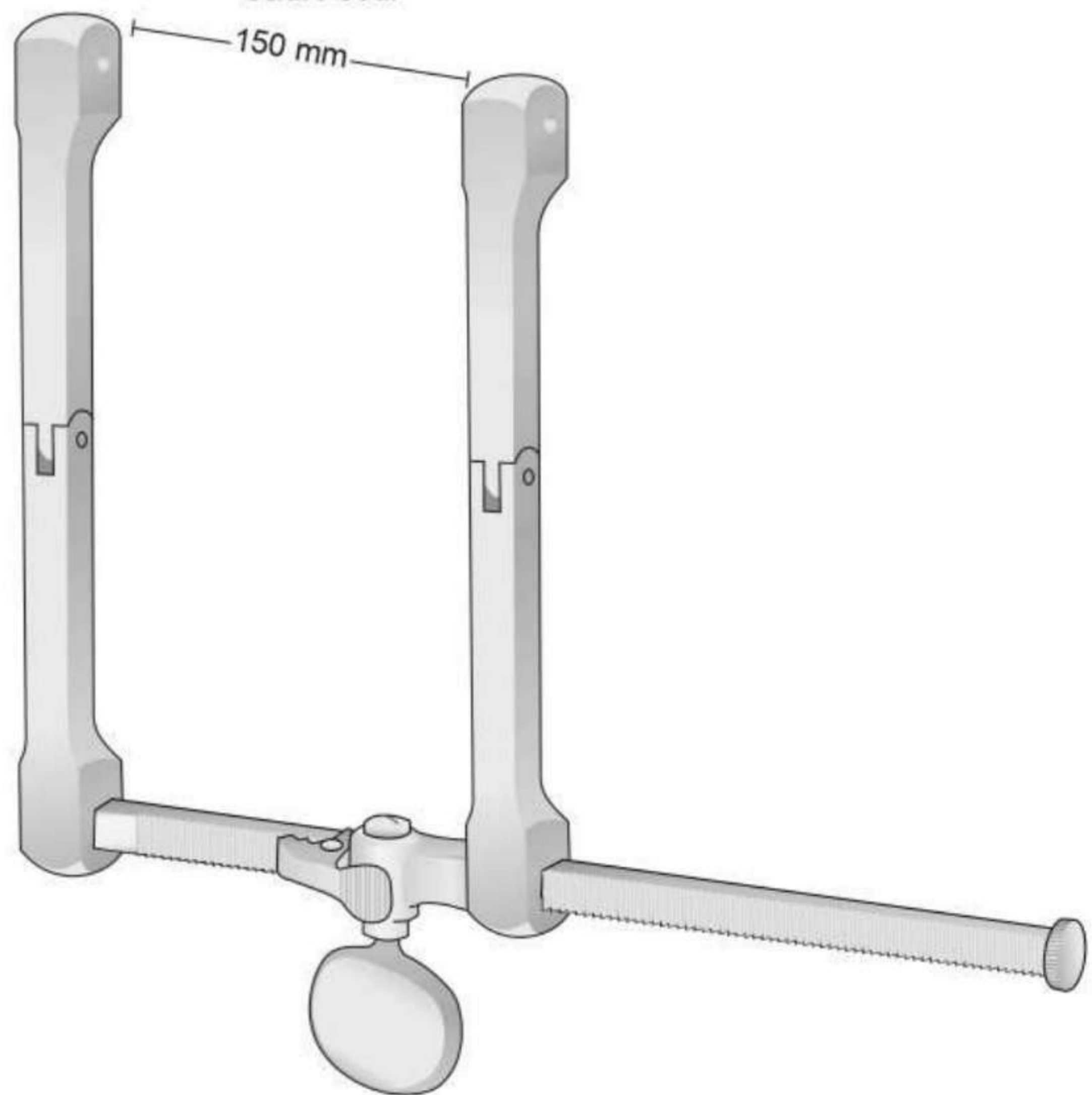

SCOVILLE-HAVERFIELD
BV-160

Retraktoren
für Laminektomie

Retractors
for Laminectomy

Divaricatori
per laminectomia

Separadores
para laminectomia

Écarteurs
pour laminectomie

Spitz
Scharp
Acuto
Agudo
Pointù



SCOVILLE
BV-163
50 mm

Spitz
Scharp
Acuto
Agudo
Pointù



SCOVILLE
BV-164
70 mm

Stumpf
Blunt
Smusso
Romo
Mousse



SCOVILLE
BV-165
50 mm

Stumpf
Blunt
Smusso
Romo
Mousse



SCOVILLE
BV-166
70 mm

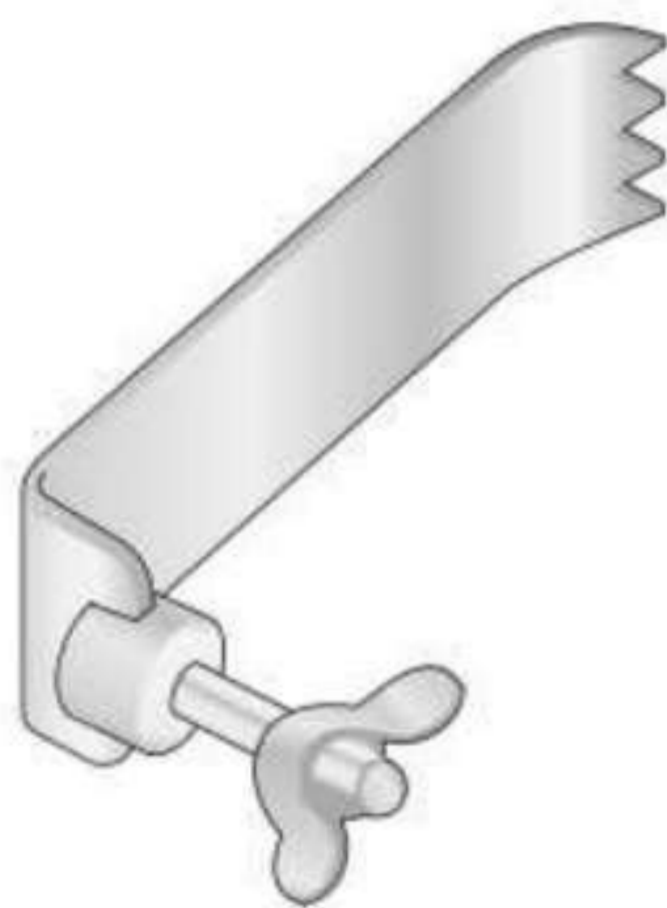

SCOVILLE
BV-167 50x25 mm
BV-168 50x50 mm
BV-169 57x38 mm
BV-170 64x25 mm
BV-171 64x50 mm
BV-172 67x30 mm
BV-173 75x25 mm
BV-174 75x50 mm
BV-175 88x25 mm
BV-176 100x50 mm

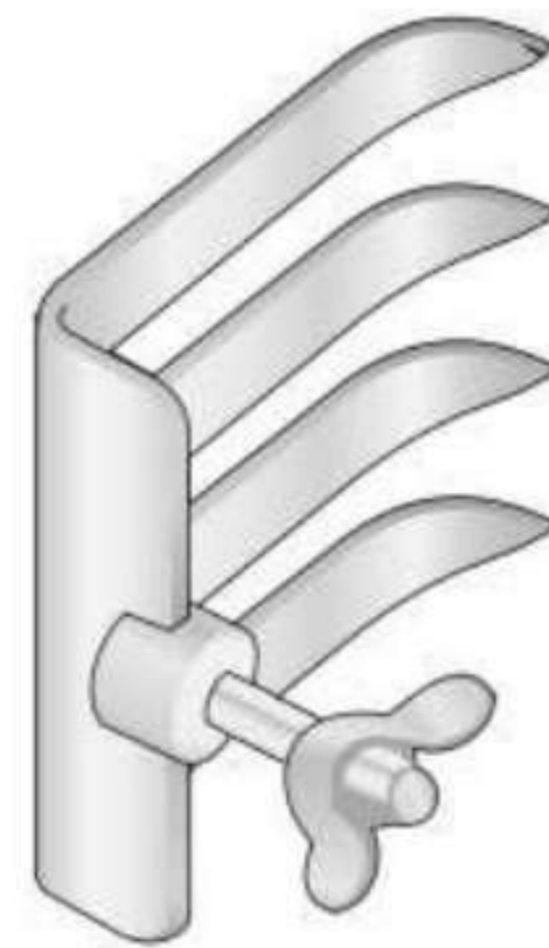

TAYLOR
BV-177 48x50 mm
BV-178 64x50 mm
BV-179 64x64 mm
BV-180 80x57 mm

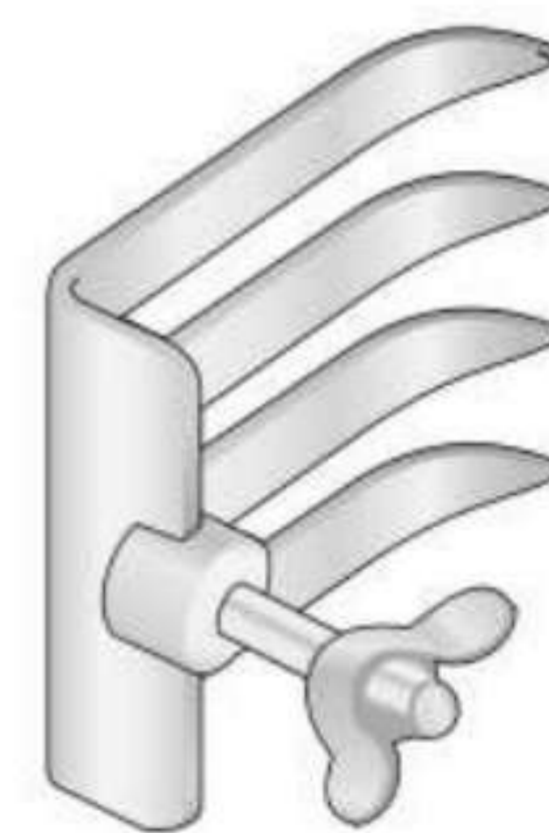

SCOVILLE
BV-181 41x38 mm
BV-182 67x44 mm

Retraktoren für
Wirbelsäule

Retractors for
Vertebral Column

Divaricatori per
la colonna vertebrale

Separadores para
la columna vertebral

Ecarteurs pour
la colonne vertébrale

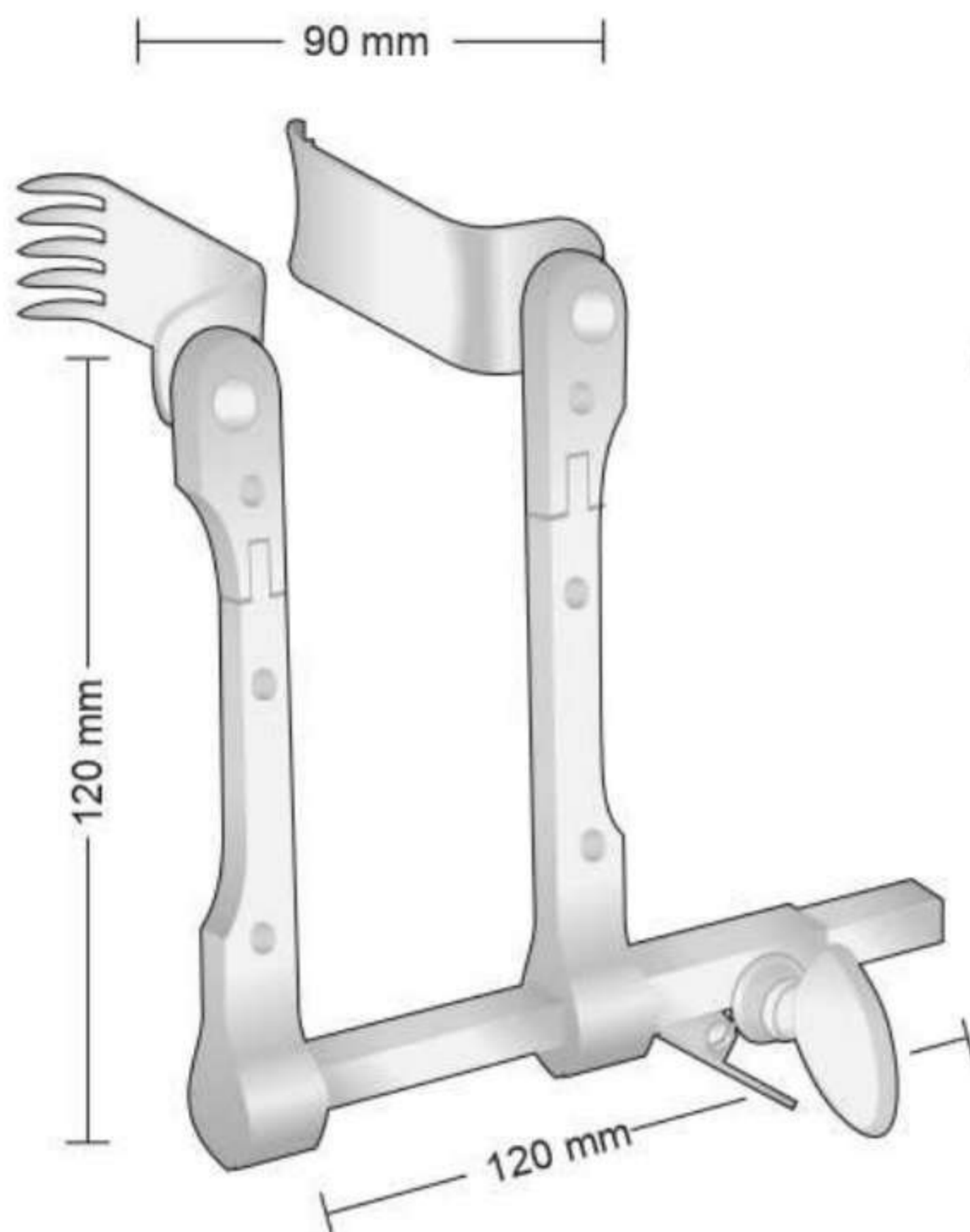

**CASPAR
BV-250**
Komplett mit 5 + 5 Blätter
Complete with 5 + 5 blade
Completo con 5 + 5 valve
Completo con 5 + 5 valvas
Complet avec 5 + 5 valves

BV-249
Sperrer allein
Retractor only
Divaricatore solo
Separador suelto
Ecarteur seul

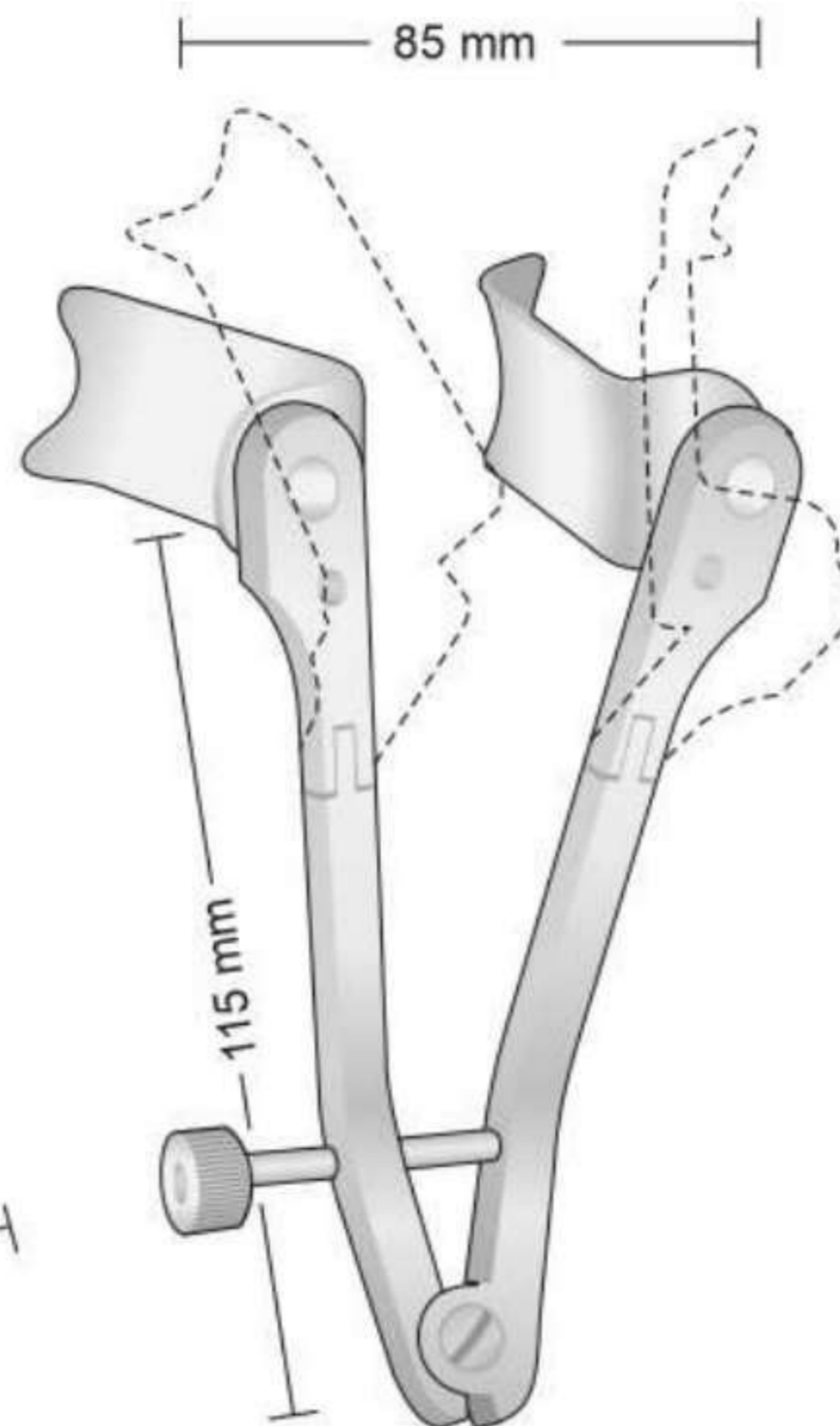

**CASPAR
BV-270**
Komplett mit 5 Blätter
Complete with 5 blade
Completo con 5 valve
Completo con 5 valvas
Complet avec 5 valves

BV-269
Sperrer allein
Retractor only
Divaricatore solo
Separador suelto
Ecarteur seul

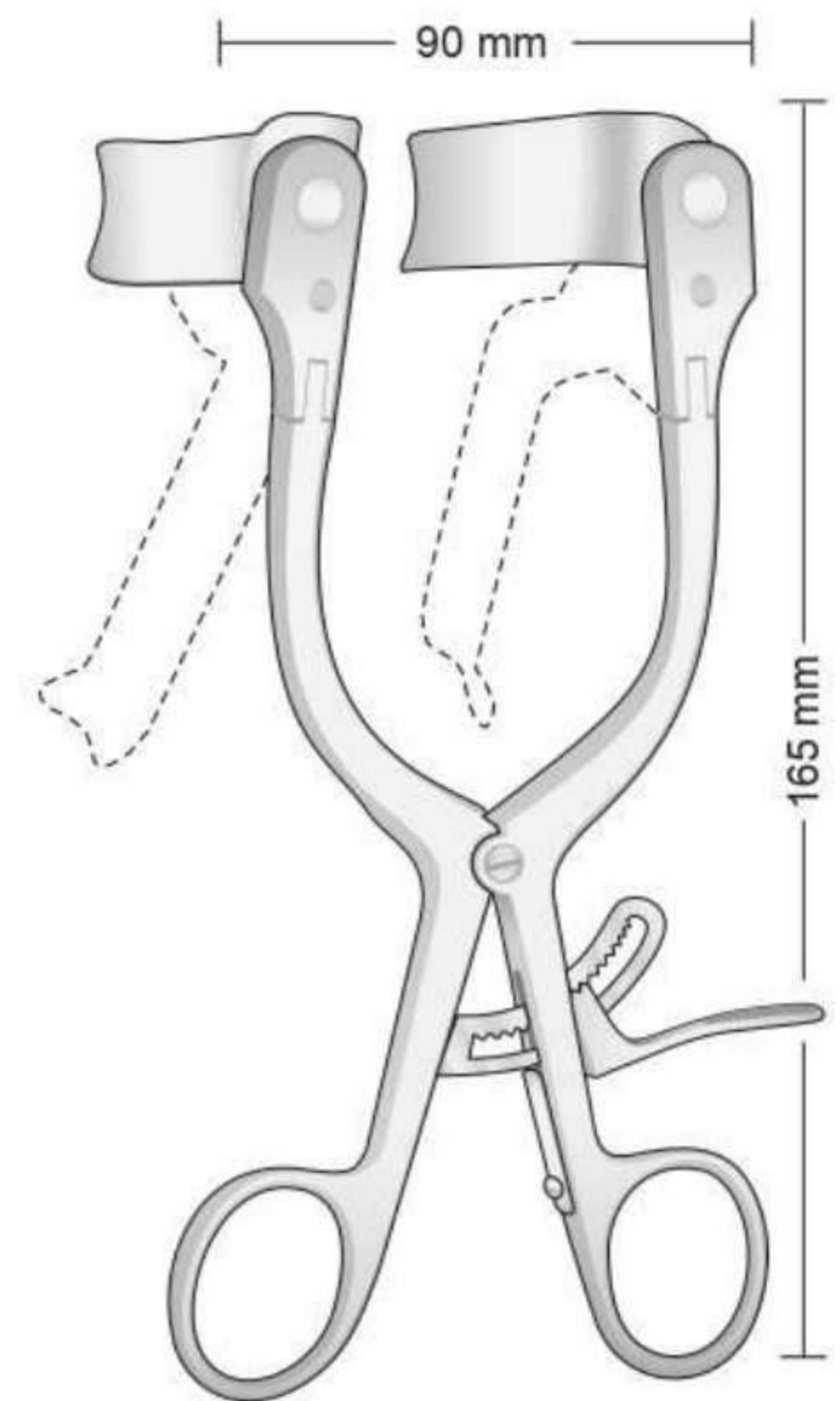

**CASPAR
BV-280**
Komplett mit 5 Blätter
Complete with 5 blade
Completo con 5 valve
Completo con 5 valvas
Complet avec 5 valves

BV-279
Sperrer allein
Retractor only
Divaricatore solo
Separador suelto
Ecarteur seul

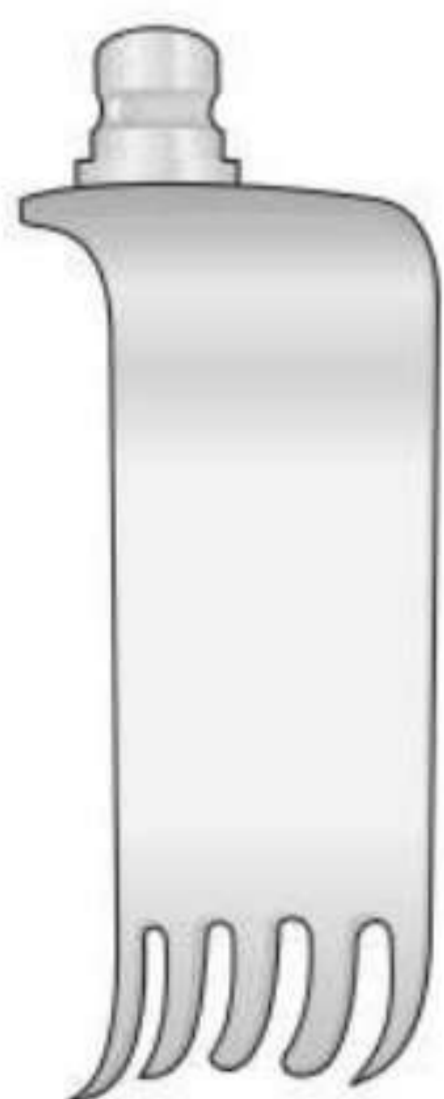

BV-251
40 x 23 mm
BV-252
45 x 23 mm
BV-253
50 x 23 mm
BV-254
55 x 23 mm
BV-255
60 x 23 mm



BV-256
40 x 23 mm
BV-257
45 x 23 mm
BV-258
50 x 23 mm
BV-259
55 x 23 mm
BV-260
60 x 23 mm



BV-271
45 x 23 mm
BV-272
50 x 23 mm
BV-273
55 x 23 mm
BV-274
60 x 23 mm
BV-275
65 x 23 mm



BV-276
50 x 25 mm
BV-277
60 x 25 mm

Titan-valven
Titanium blades
Valve in titanio
Valvas in titanio
Valves en titane



BV-281 T	25 x 24 mm
BV-282 T	30 x 24 mm
BV-283 T	35 x 24 mm
BV-284 T	40 x 24 mm
BV-285 T	45 x 24 mm
BV-286 T	25 x 24 mm
BV-287 T	30 x 24 mm
BV-288 T	35 x 24 mm
BV-289 T	40 x 24 mm
BV-290 T	45 x 24 mm



BV-291 T	25 x 24 mm
BV-292 T	30 x 24 mm
BV-293 T	35 x 24 mm
BV-294 T	40 x 24 mm
BV-295 T	45 x 24 mm
BV-296 T	50 x 24 mm
BV-297 T	55 x 24 mm
BV-298 T	60 x 24 mm
BV-299 T	65 x 24 mm
BV-300 T	70 x 24 mm



BV-301 T	30 x 24 mm
BV-302 T	35 x 24 mm
BV-303 T	40 x 24 mm
BV-304 T	45 x 24 mm
BV-305 T	50 x 24 mm
BV-306 T	55 x 24 mm
BV-307 T	60 x 24 mm
BV-308 T	65 x 24 mm
BV-309 T	70 x 24 mm
BV-310 T	75 x 24 mm

Pinzette zum wechseln der valven
mit kugelschnellverschluss
Blade ejector for changing the blades
with ball snap closure
Pinzetta per la sostituzione delle valve
con i bloccaggi rapidi a sfera
Pincettes pour changer les valves munies
du système de verrouillage rapide à billes

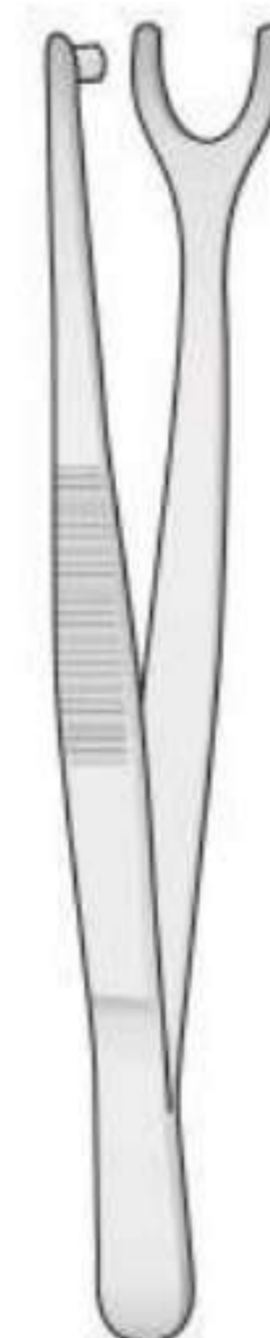

BV-229
115 mm

Mikrodiskektomie

Retractors for Micro Lumbar Discectomy

Divaricatori per micro dissectomia lombare

Separadores para micro discectomia lumbar

Écarteurs pour micro discectomie lombaire

Oberfläche schwarz beschichtet
Surface black-coated

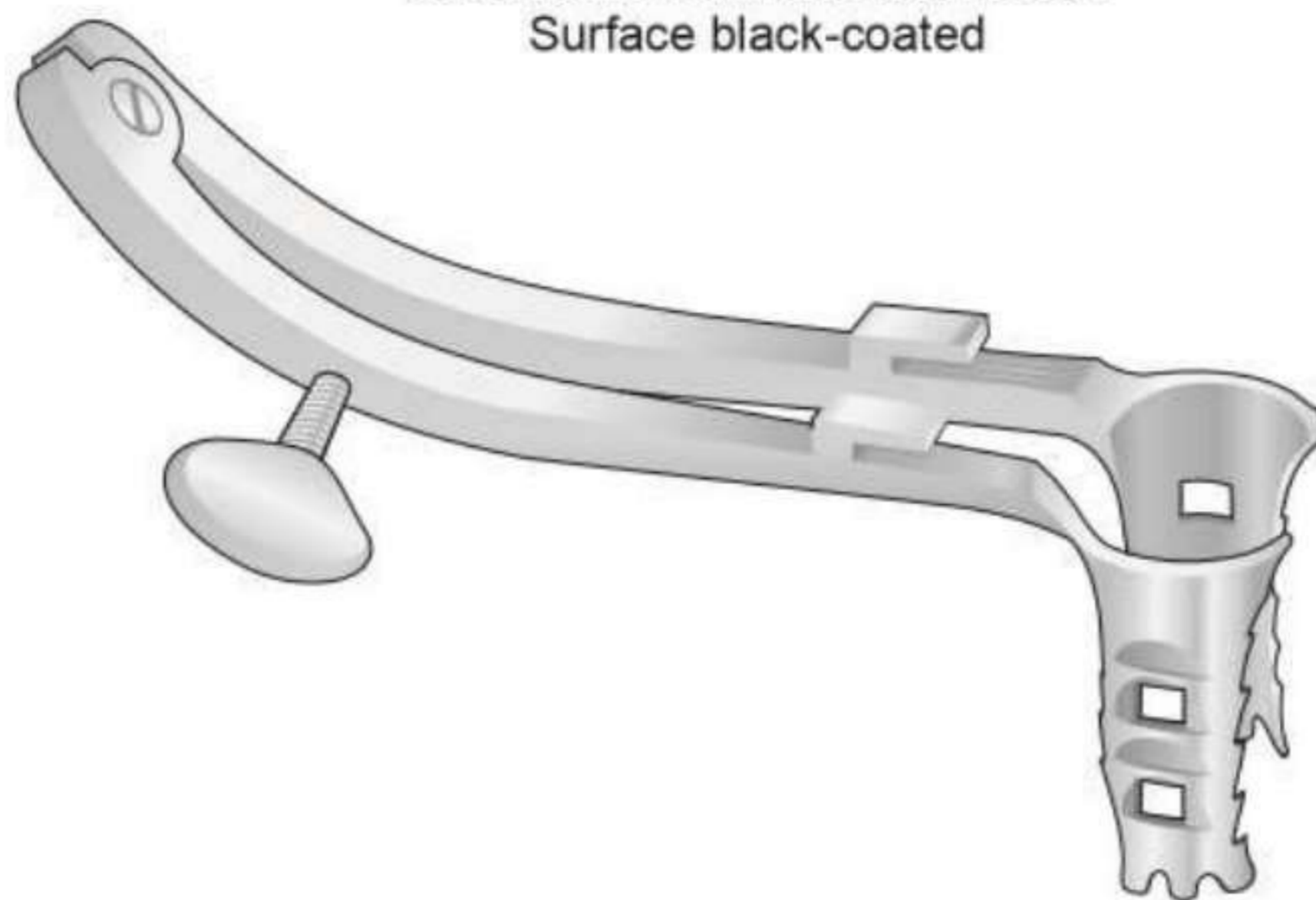

CASPAR
BV-201/BV-208

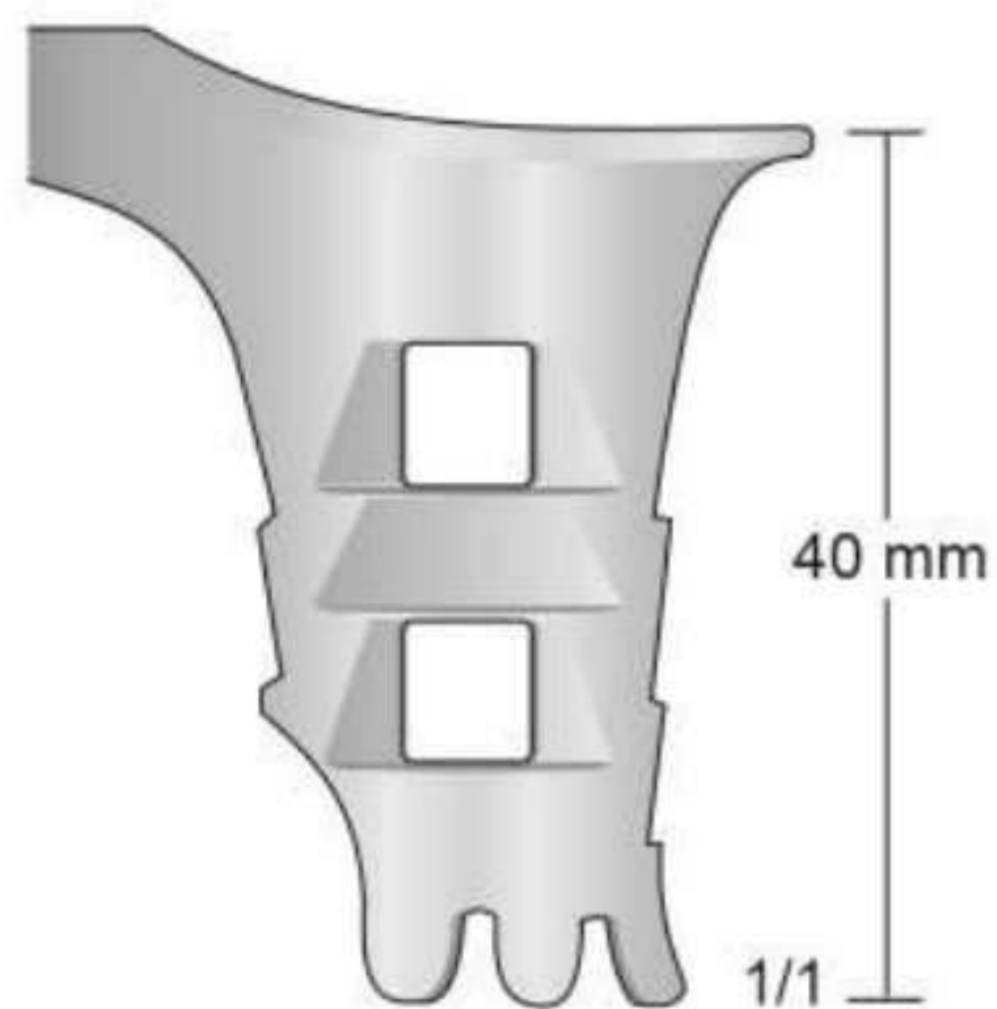

BV-201

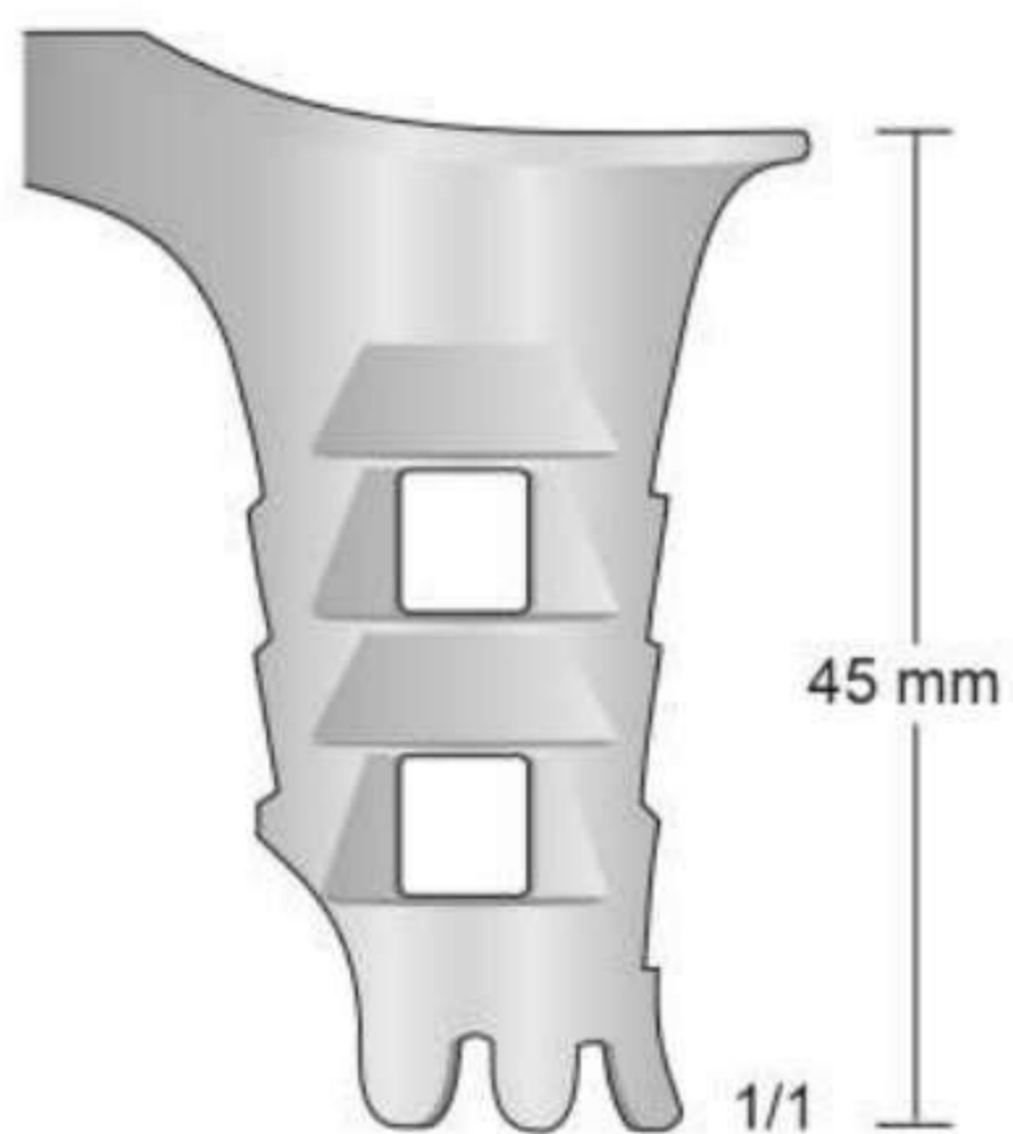

BV-202

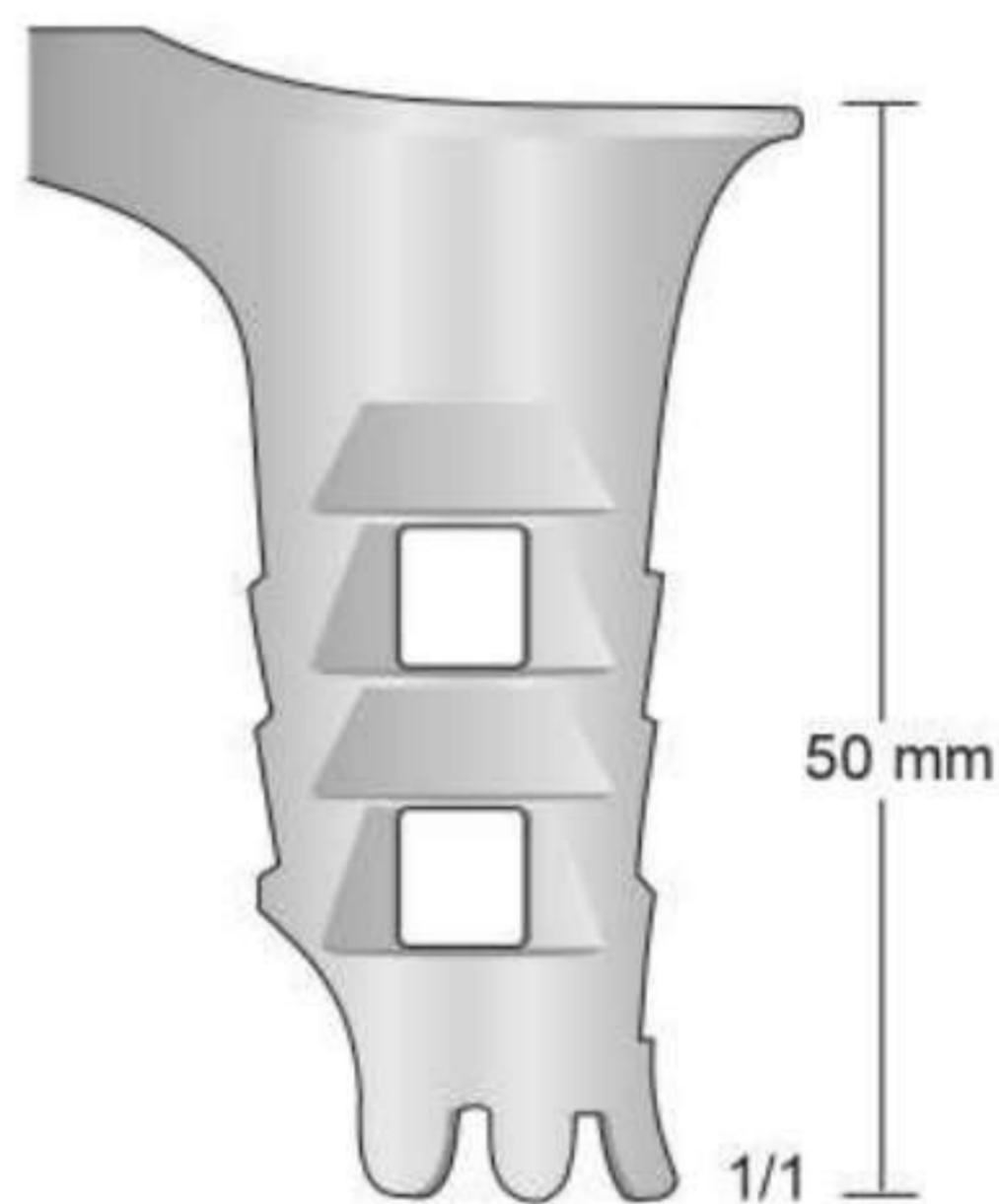

BV-203

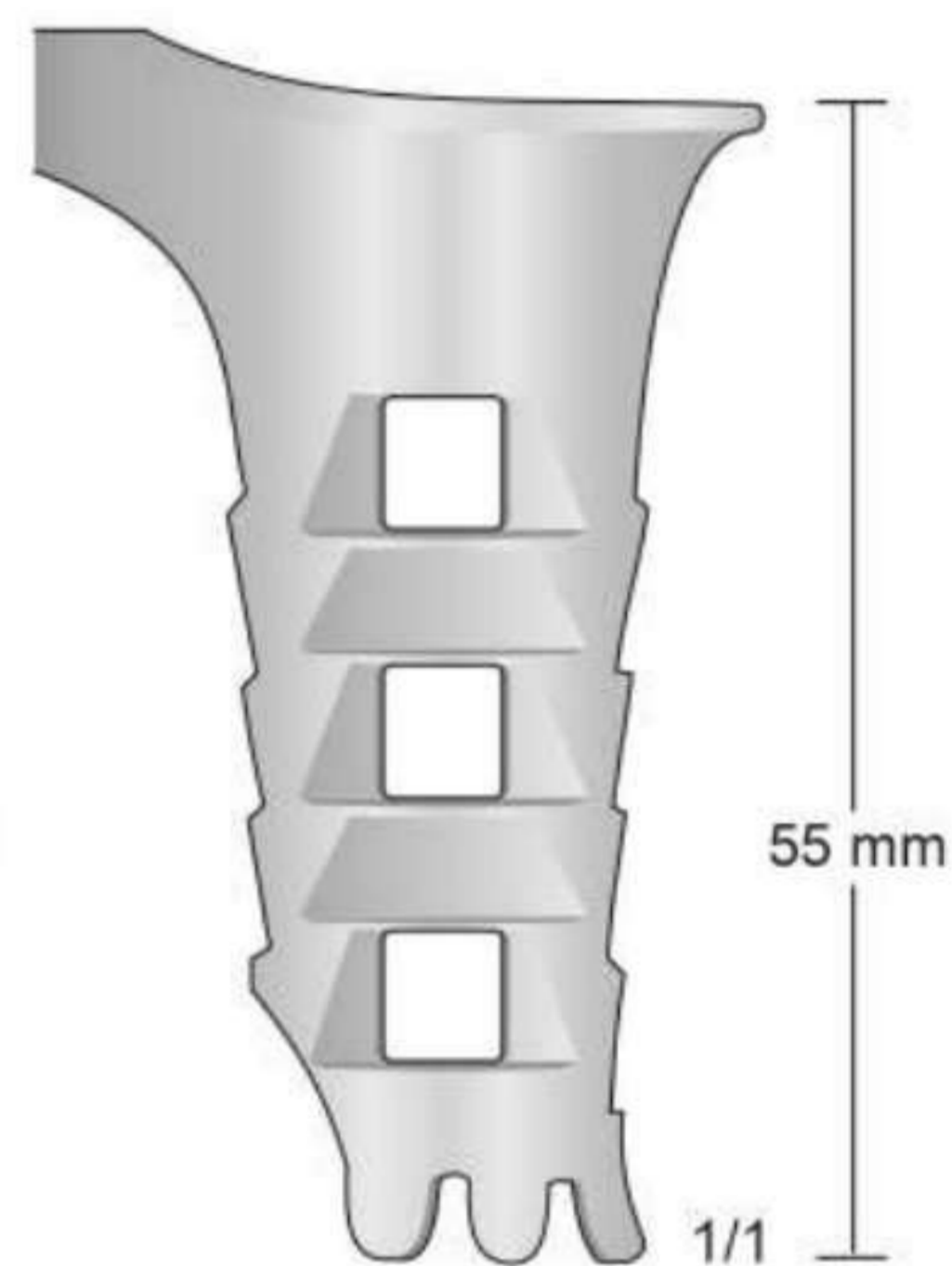

BV-204

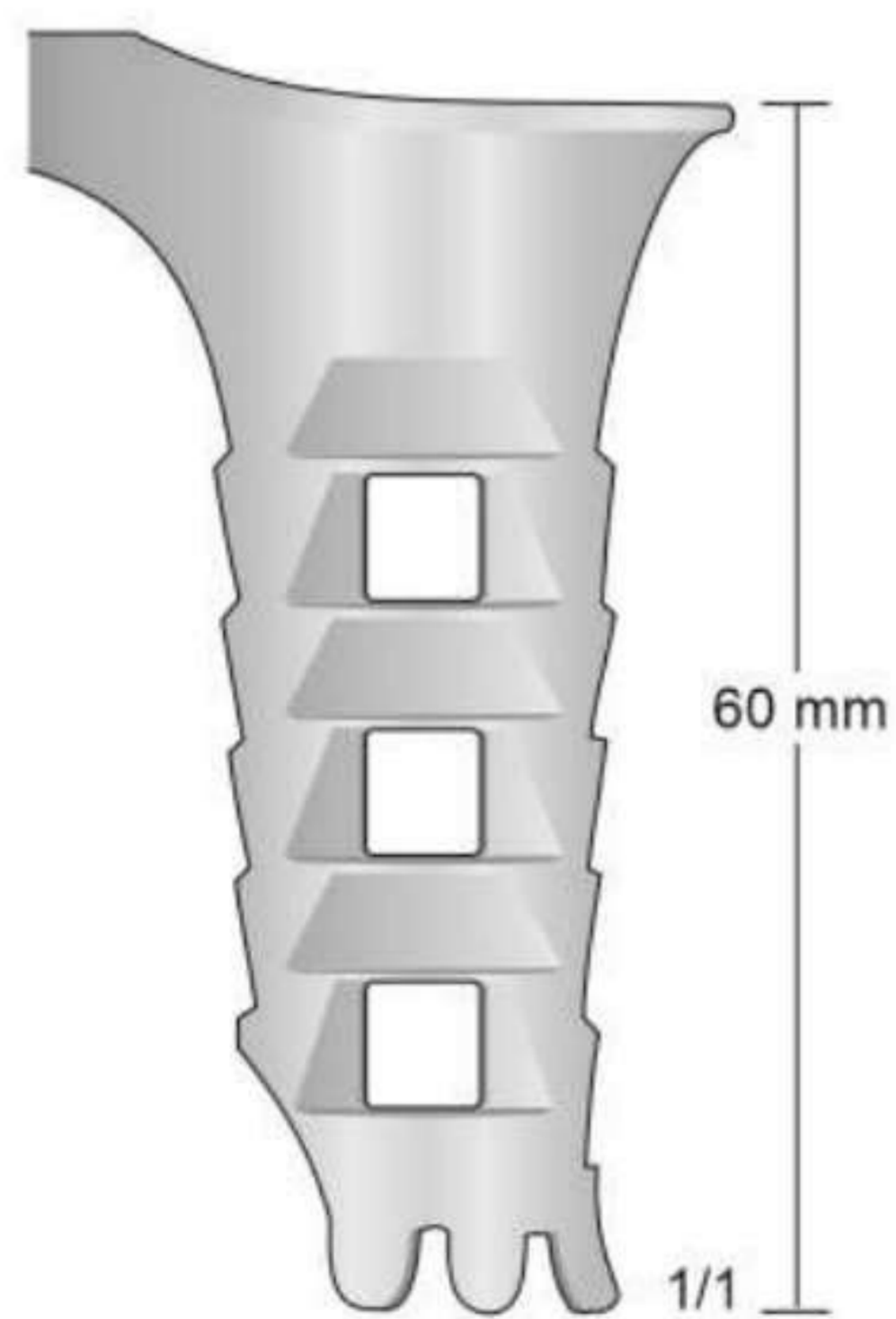

BV-205

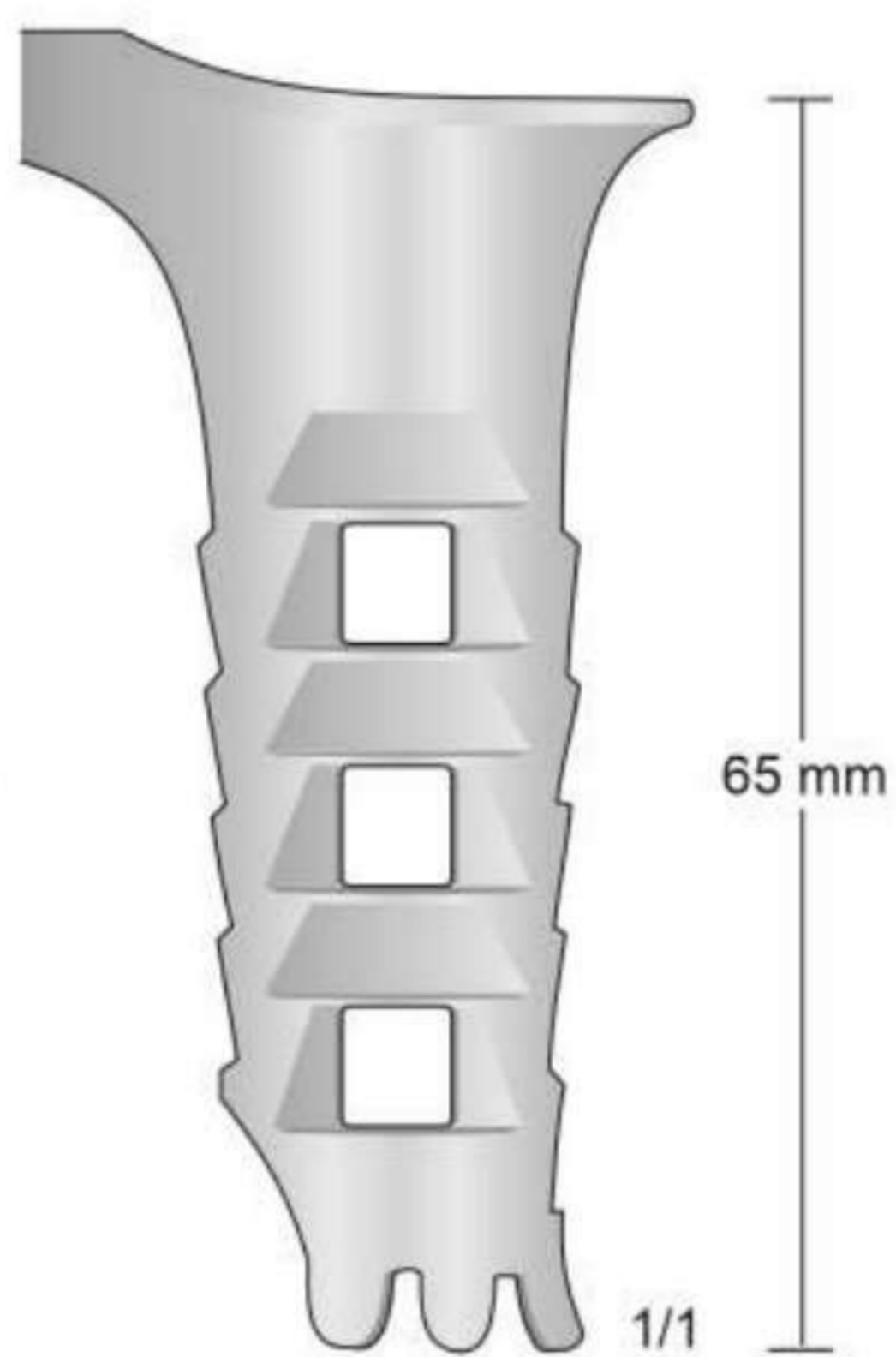

BV-206

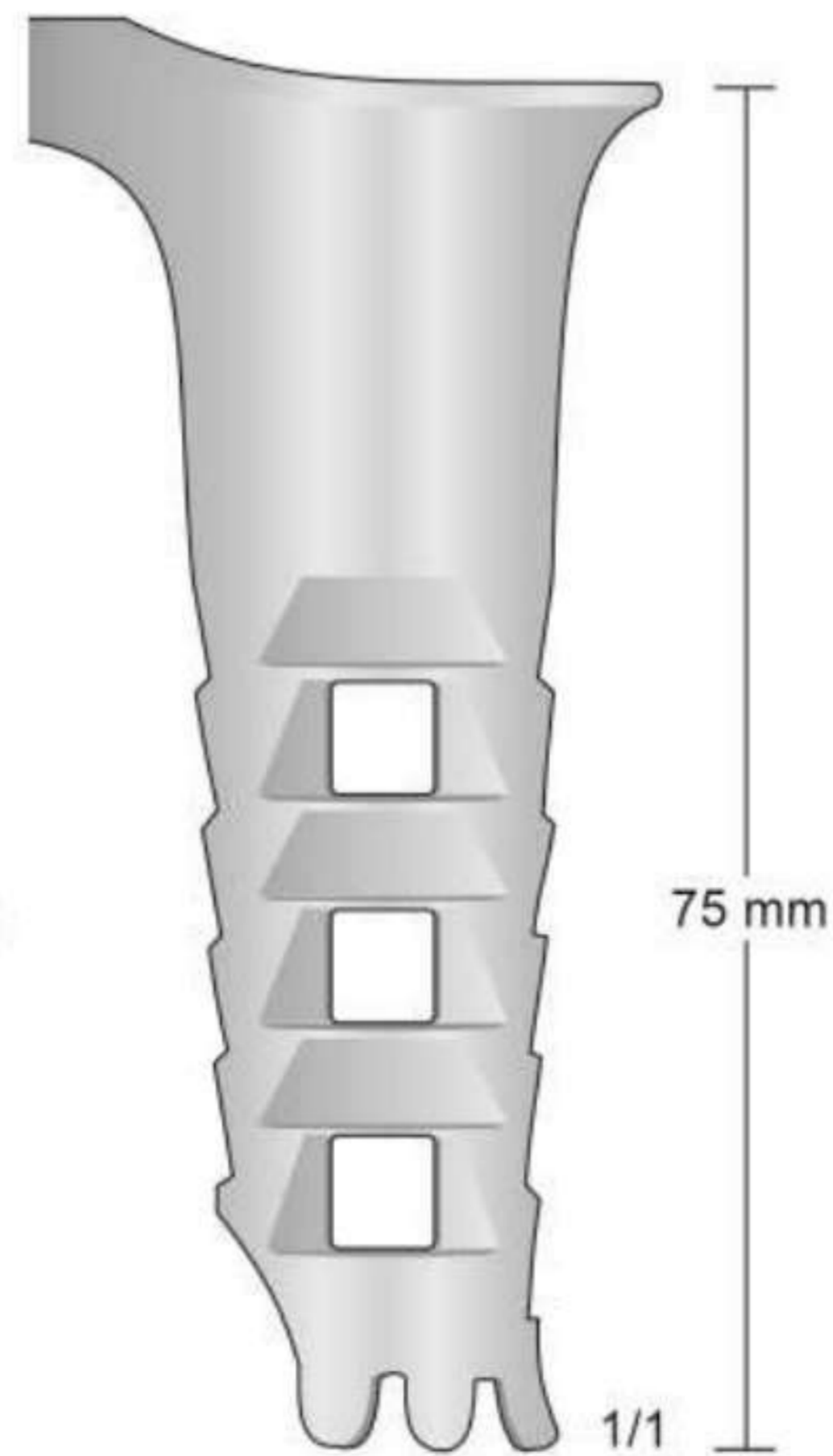

BV-207

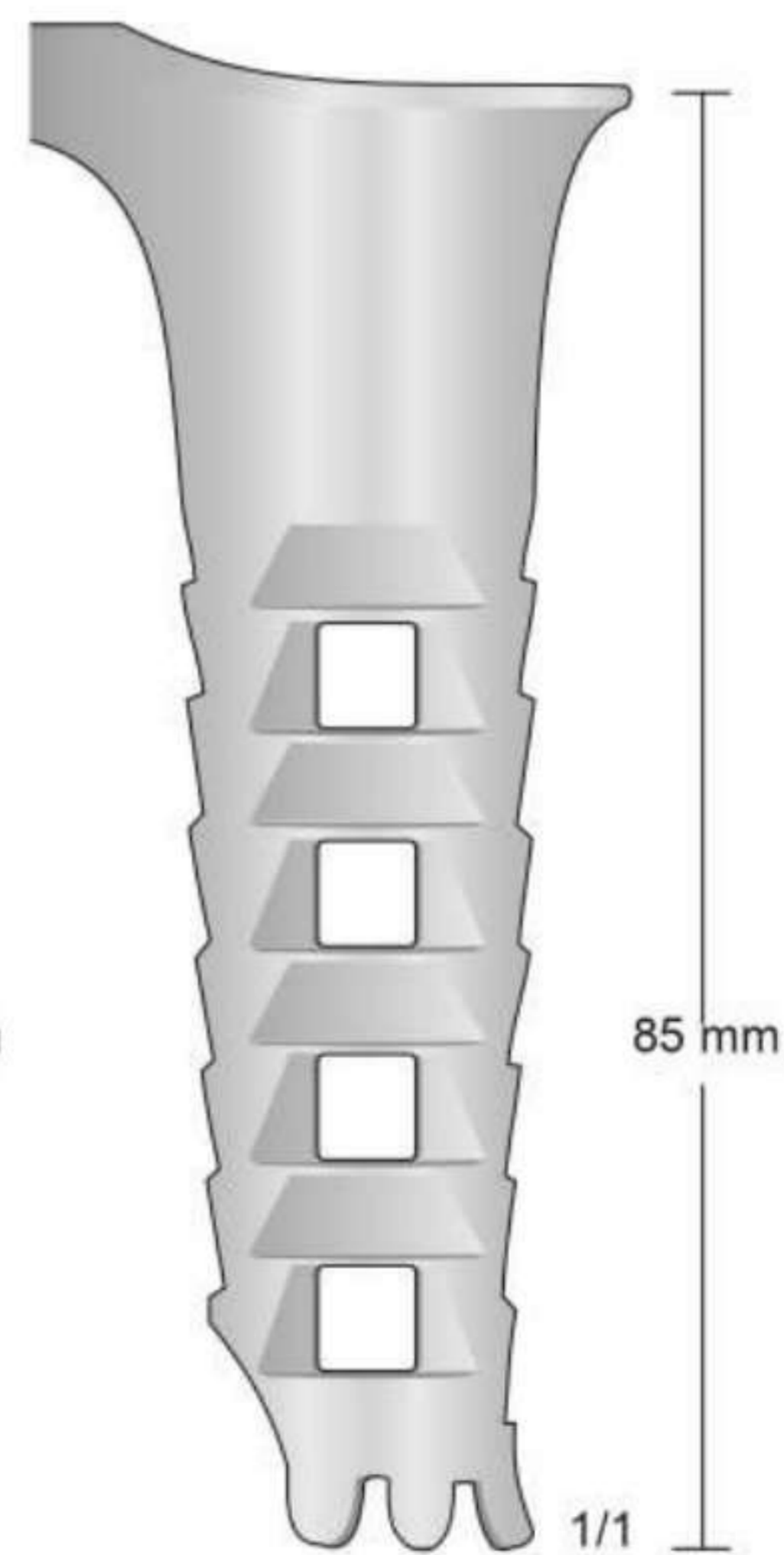

BV-208

Retraktoren für
Mikrodiskektomie

Retractors for Micro
Lumbar Discectomy

Divaricatori per micro
dissectomia lombare

Separadores para micro
dissectomía lumbar

Écarteurs pour micro
dissectomie lombaire

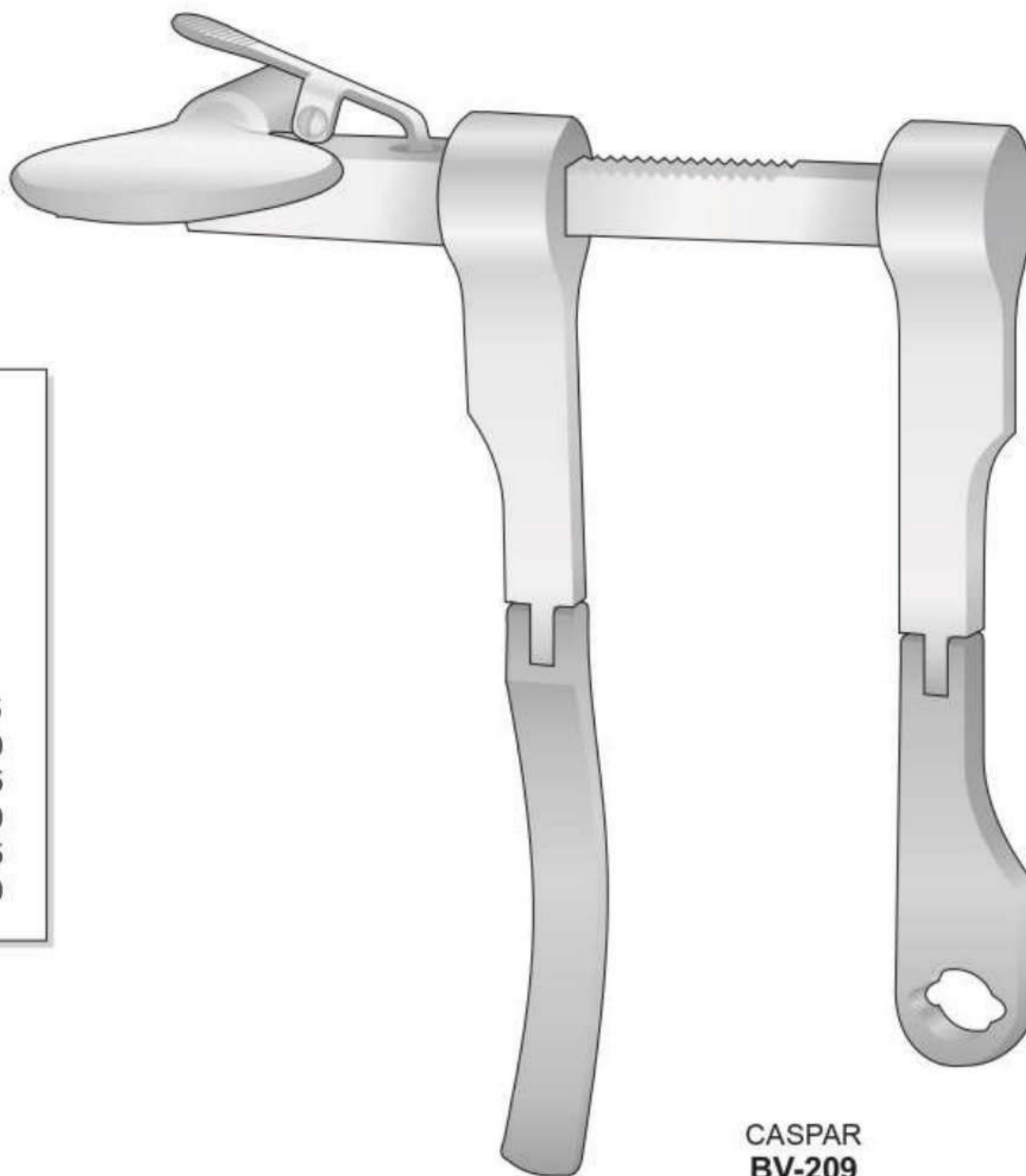

**CASPAR
BV-210**

Sperrer komplett mit
Retractor complete with
Divaricatore completo di
Separador completo con
Ecarteur complet avec

- BV-211** Valva anti-rifleso mm. 35
- BV-212** Valva anti-rifleso mm. 40
- BV-213** Valva anti-rifleso mm. 45
- BV-214** Valva anti-rifleso mm. 50
- BV-215** Valva anti-rifleso mm. 55
- BV-216** Valva anti-rifleso mm. 60

BV-209

Sperrer allein
Retractor only
Divaricatore solo
Separador suelto
Ecarteur seul

**CASPAR
BV-209**

Oberfläche schwarz Beschichtet
Surface Black-coated
Valve anti-rifleso
Surface noircie

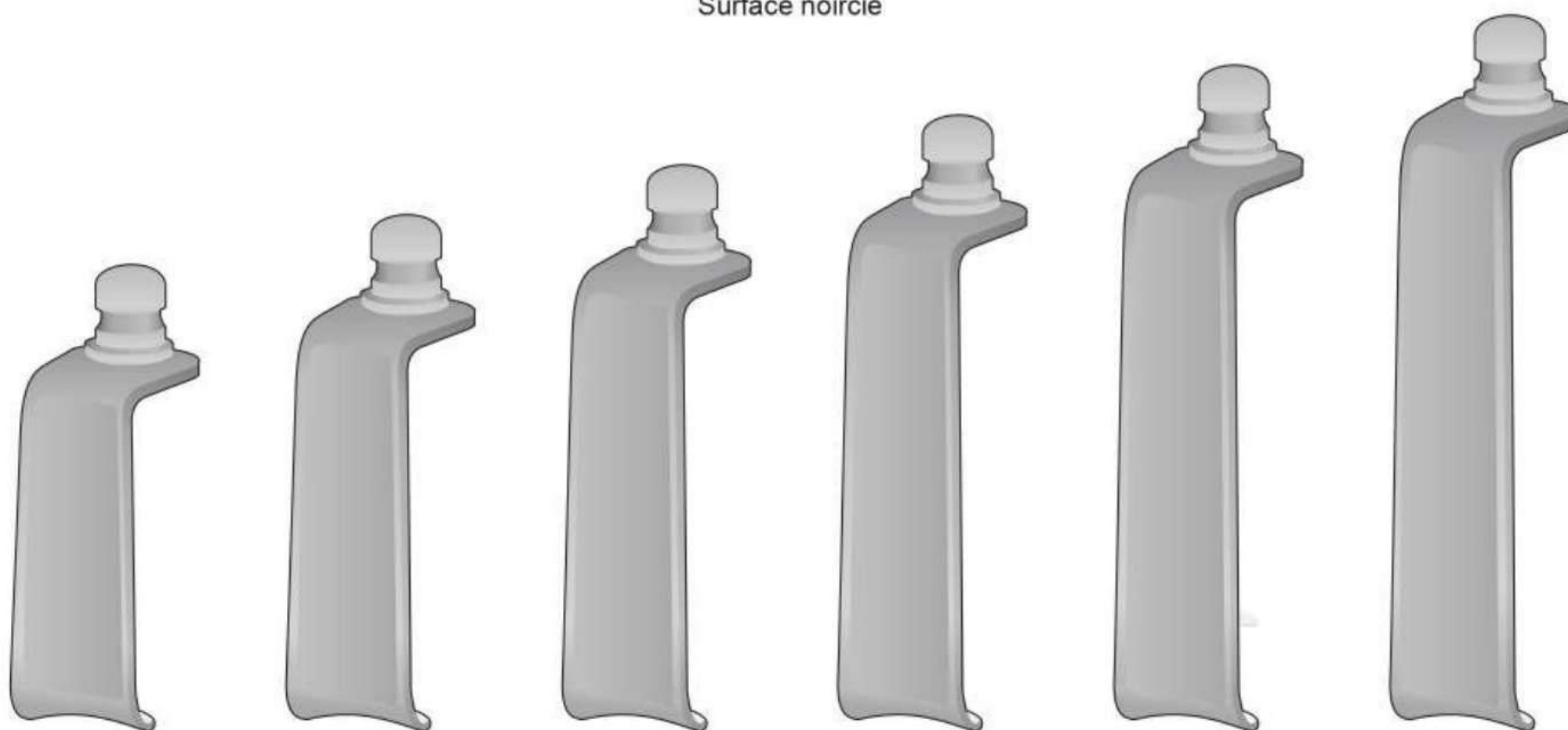

BV-211
35 mm

BV-212
40 mm

BV-213
45 mm

BV-214
50 mm

BV-215
55 mm

BV-216
60 mm

CASPAR
FF-190
Distraktor komplett rechts
Distractor complete right
Distrattore completo destro
FF-191 1 Distraktor allein - 1 Distractor only
FF-192 1 Bohrbüchse - 1 Drilling Guide
FF-203 1 Spezialbohrer - 1 Special Drill
FF-205 2 Distractionsschrauben - 2 Distraction Screws
FF-206 1 Schraubendreher - 1 Screw Driver

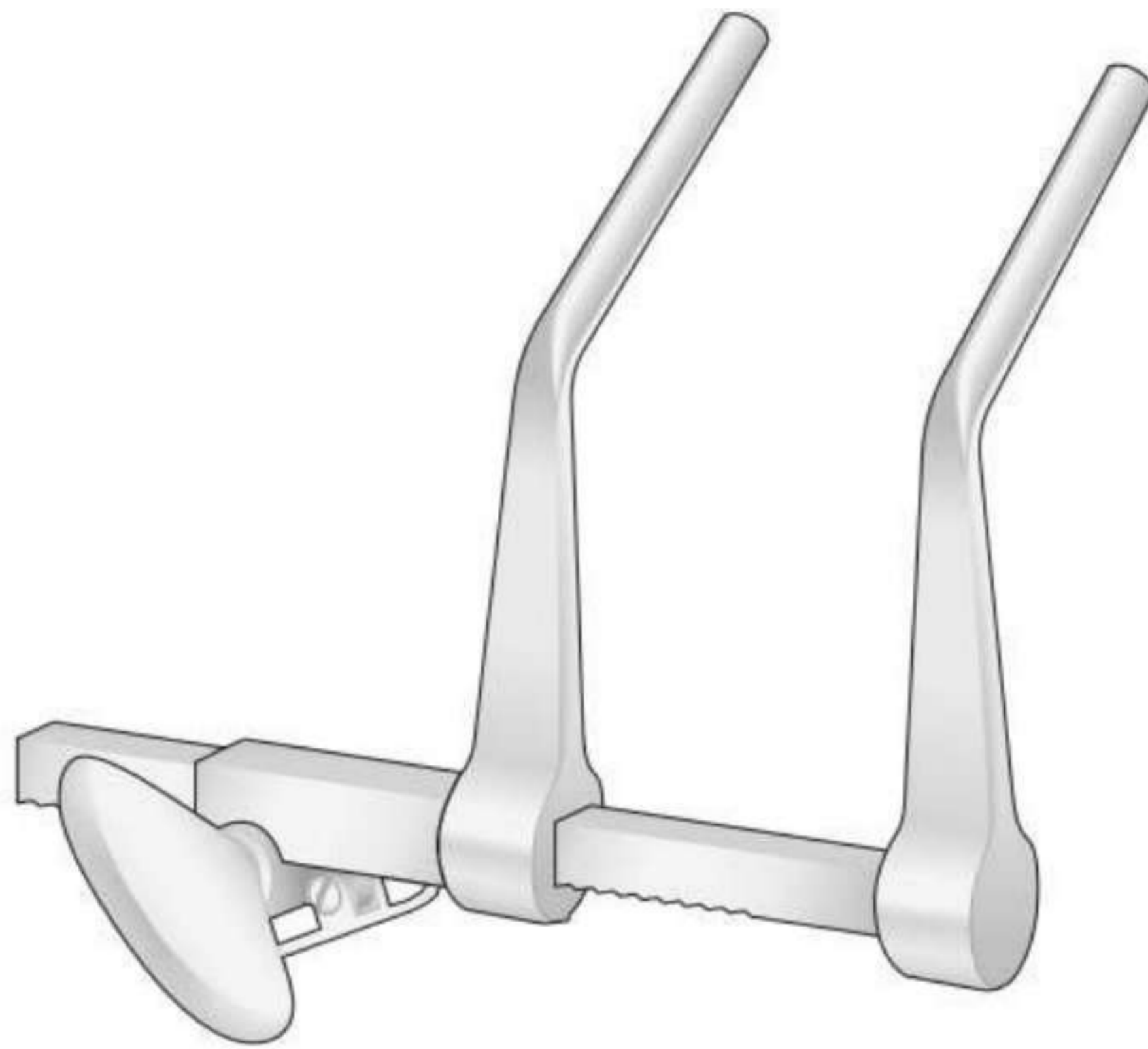

CASPAR
FF-191
Distrattore destro, solo

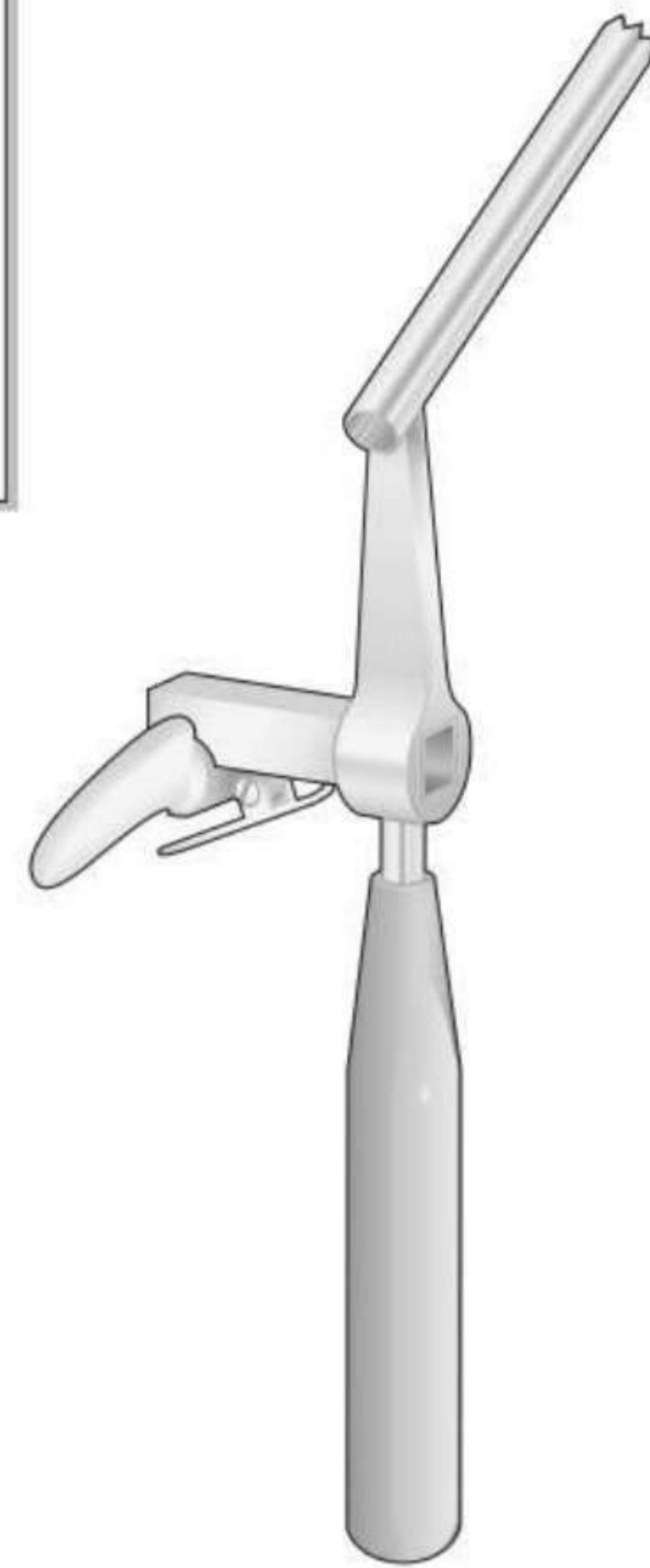

FF-192
Guida punte destro, solo

CASPAR
FF-200
Distraktor komplett links
Distractor complete left
Distrattore completo sinistro
FF-201 1 Distraktor allein - 1 Distractor only
FF-202 1 Bohrbüchse - 1 Drilling Guide
FF-203 1 Spezialbohrer - 1 Special Drill
FF-205 2 Distractionsschrauben - 2 Distraction Screws
FF-206 1 Schraubendreher - 1 Screw Driver

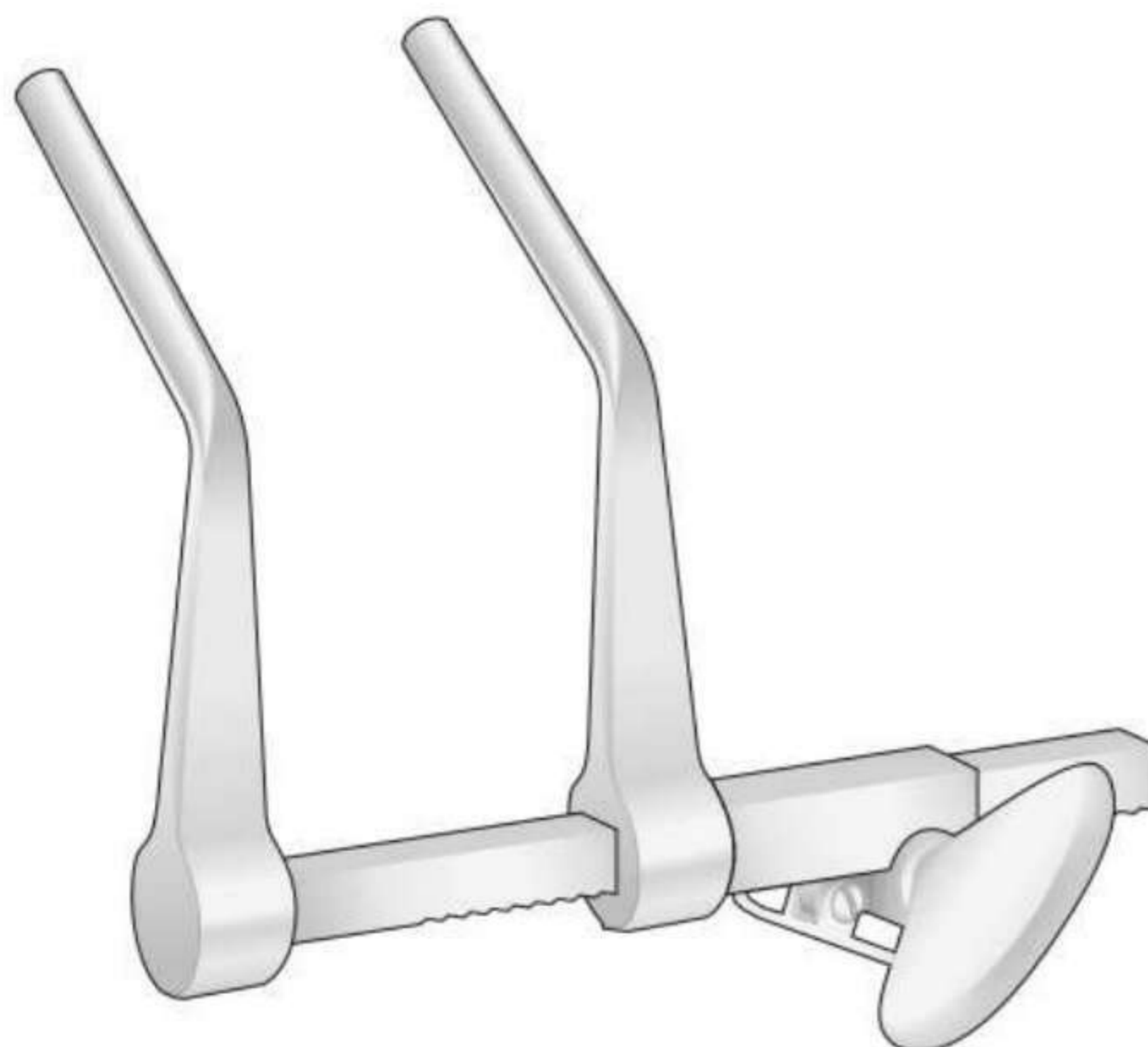

CASPAR
FF-201
Distrattore sinistro, solo

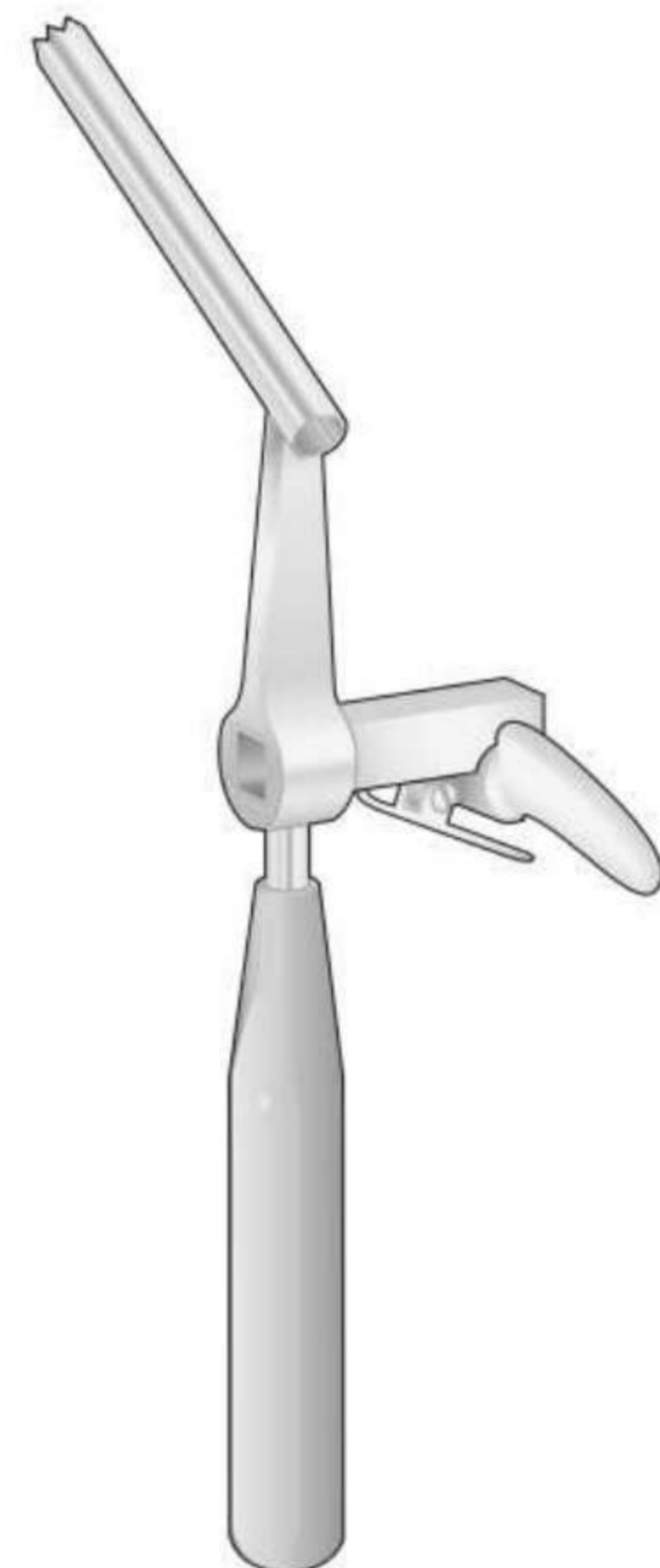

FF-202
Guida punte sinistro, solo

Retraktoren für
Wirbelsäule

Retractors for
Vertebral Column

Divaricatori per
la colonna vertebrale

Separadores para
la columna vertebral

Ecarteurs pour
la colonne vertébrale

Spezialbohrer
Special Drill
Ø 1,7 mm

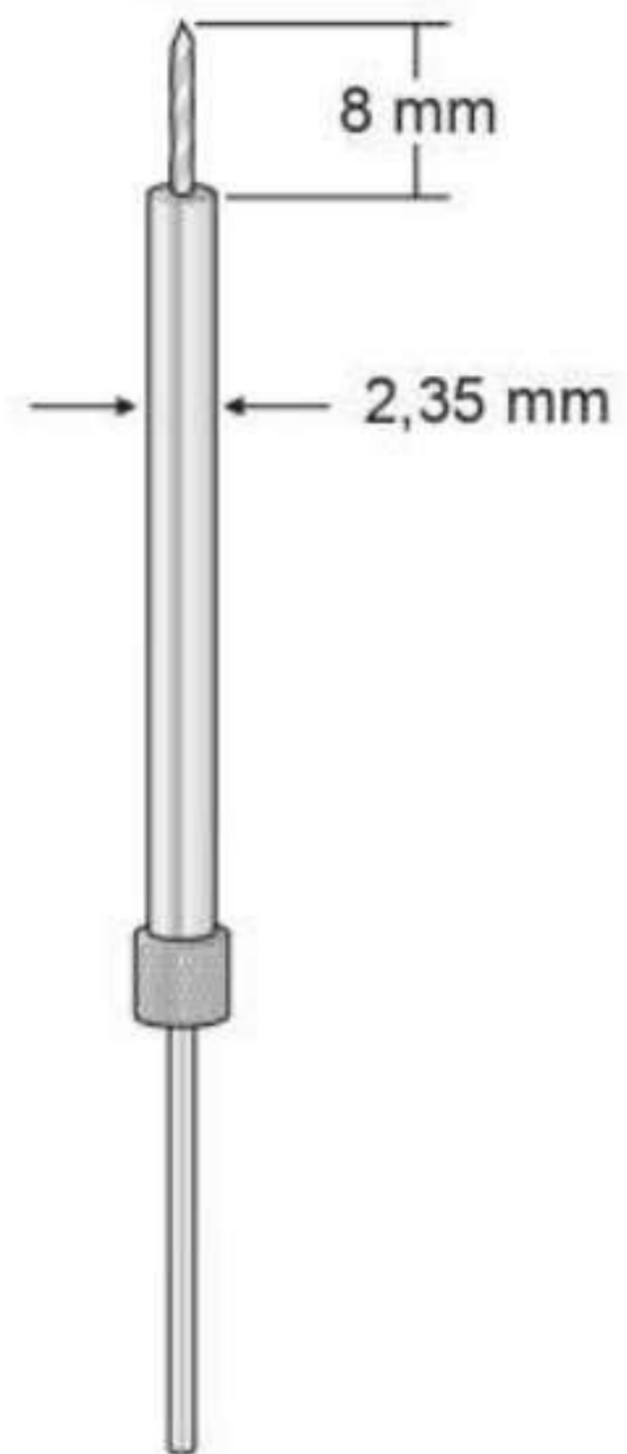

CASPAR
FF-203
145 mm

Distraktionsschrauben
Distraction Screw

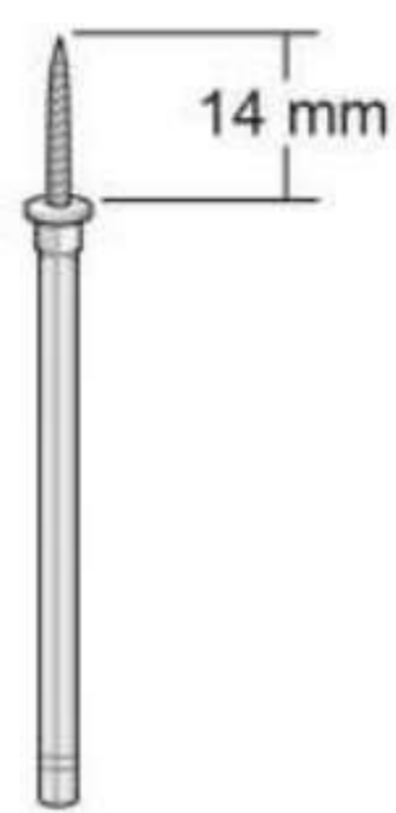

CASPAR
FF-204
70 mm

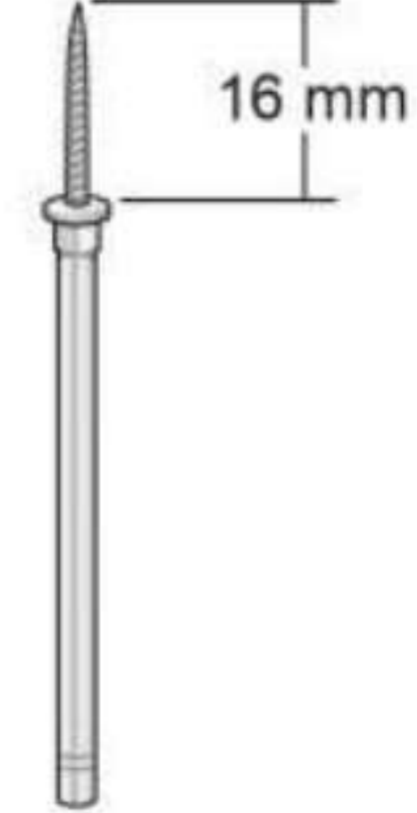

CASPAR
FF-205
70 mm

Schraubendreher
Screw Driver



CASPAR
FF-206
200 mm

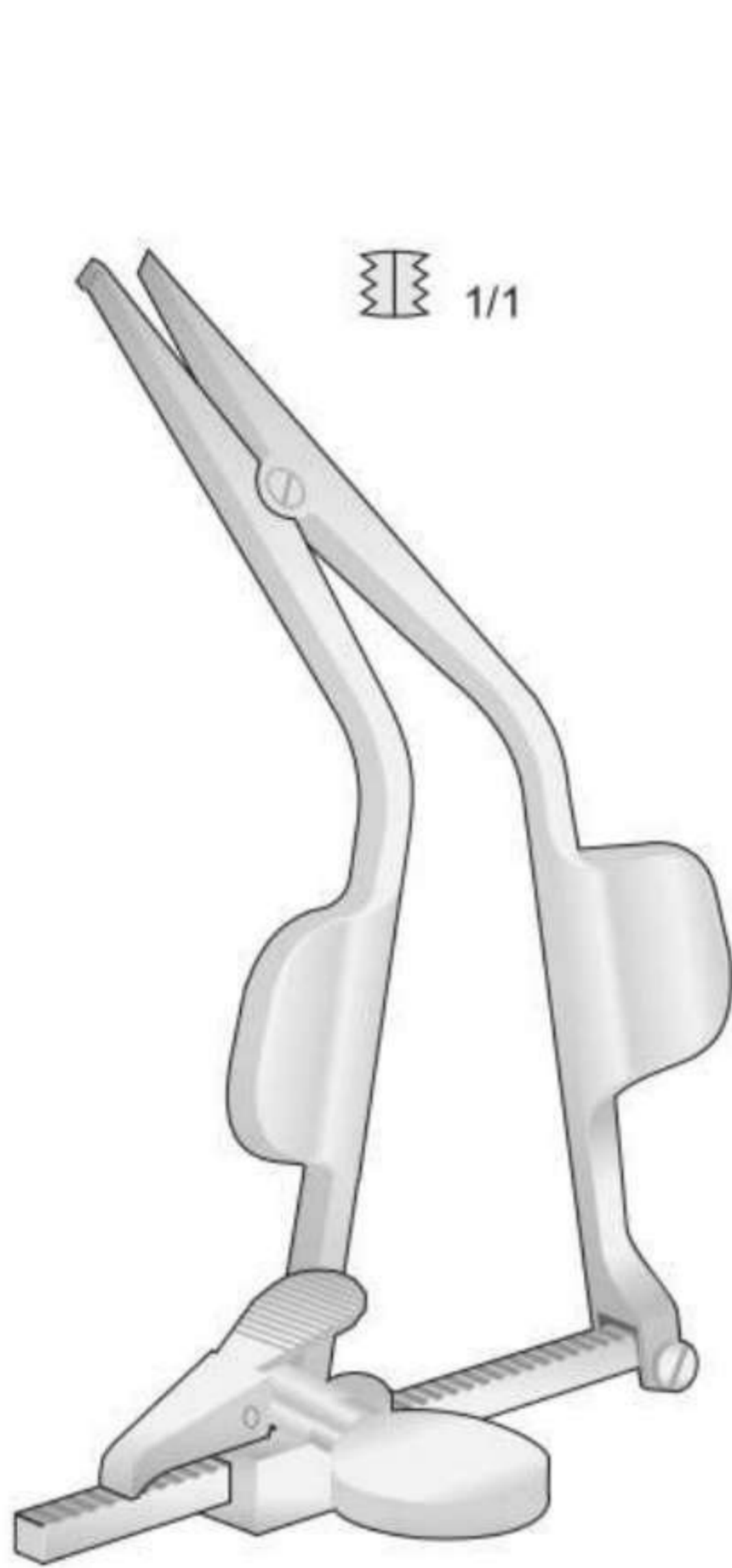

CLOWARD
BV-86
150 mm

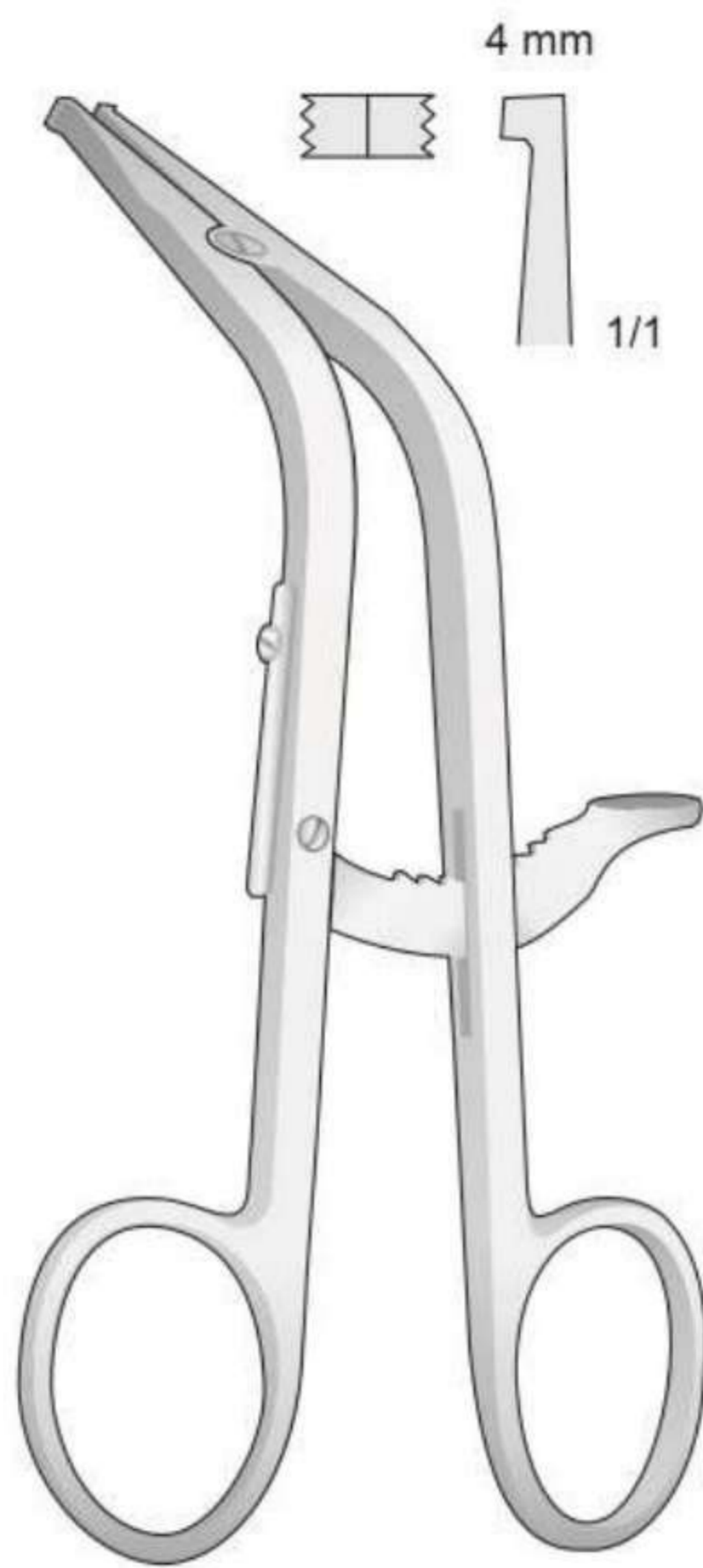

CLOWARD
BV-84
160 mm

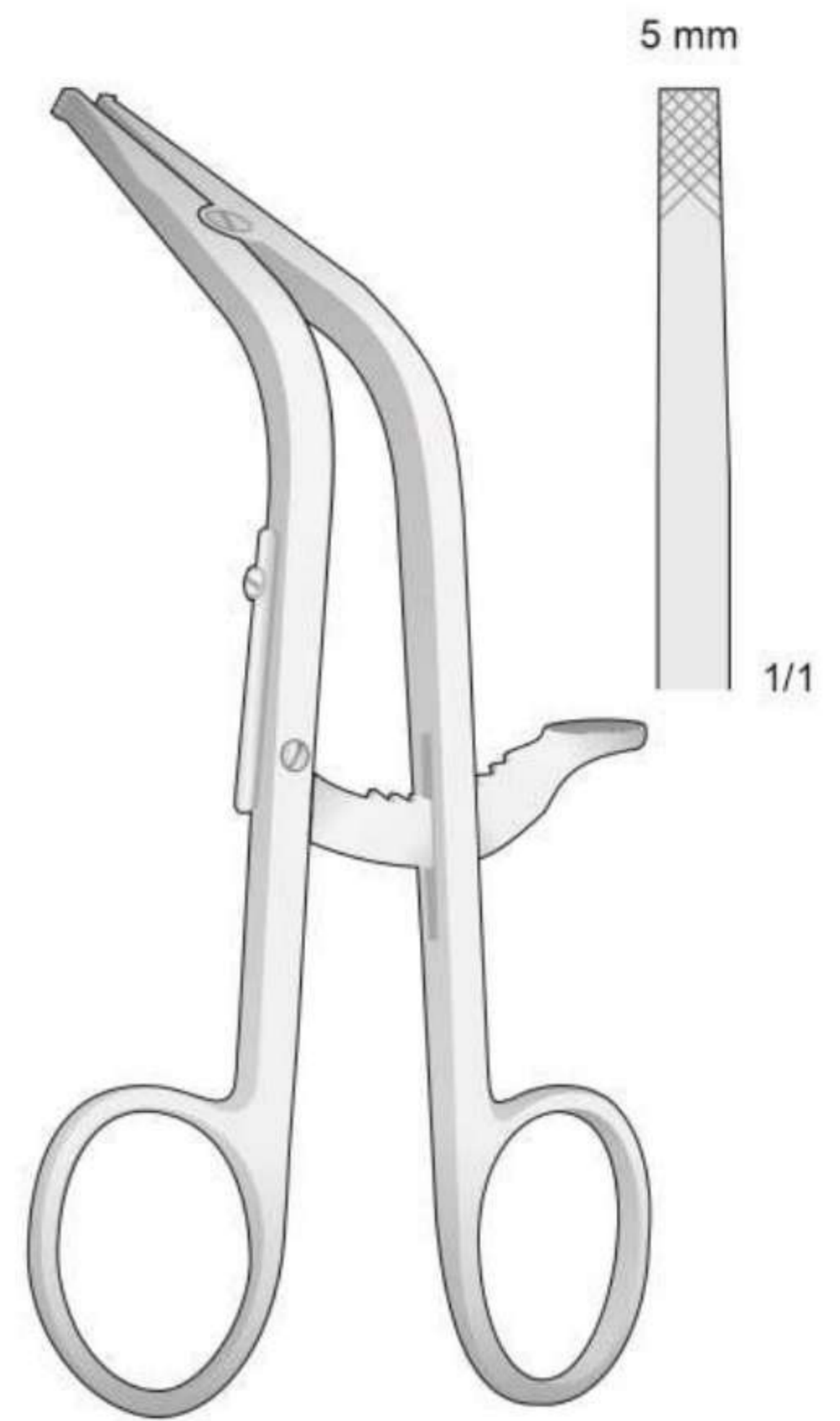

CLOWARD
BV-85
160 mm

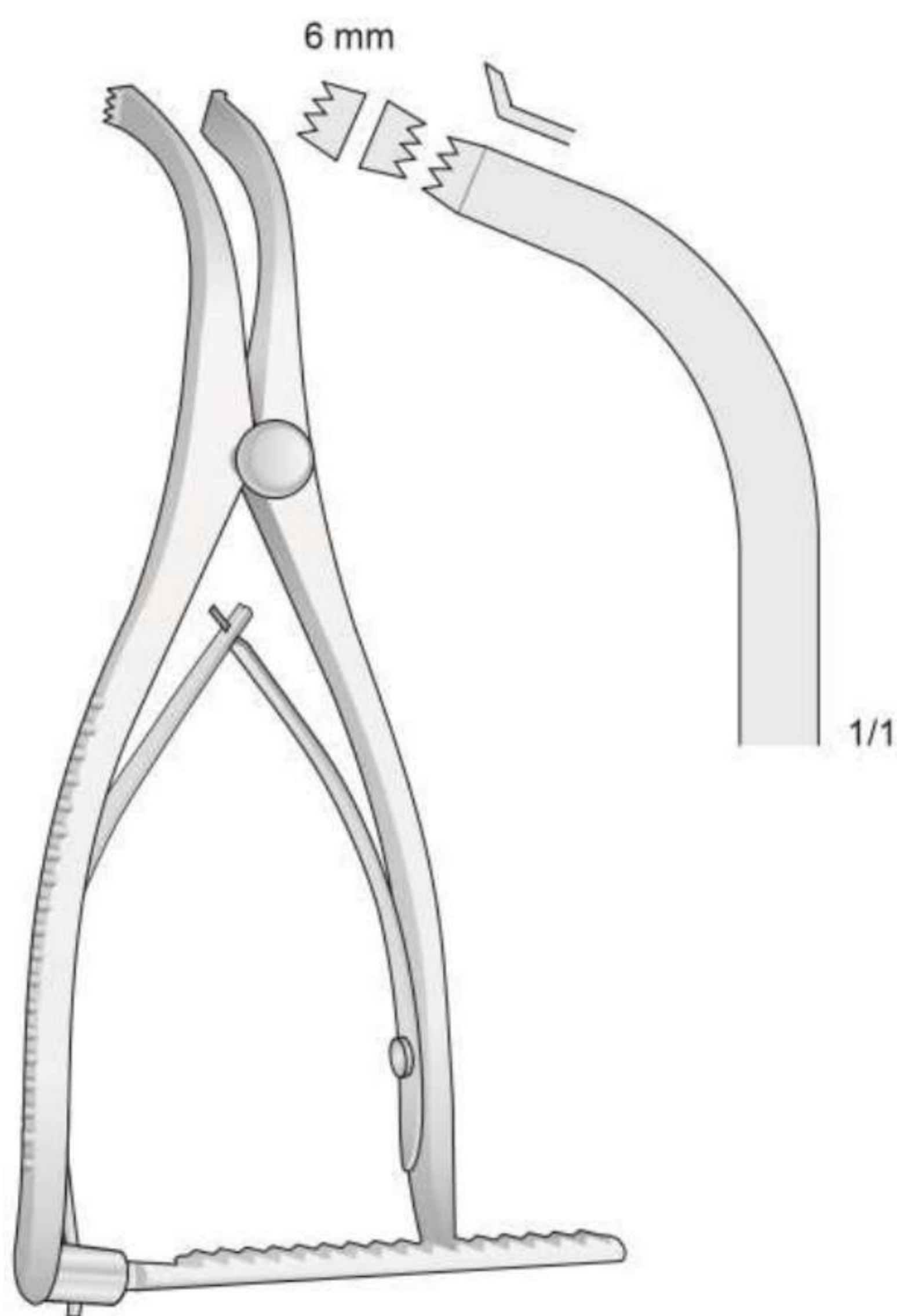

INGE
BV-80
160 mm

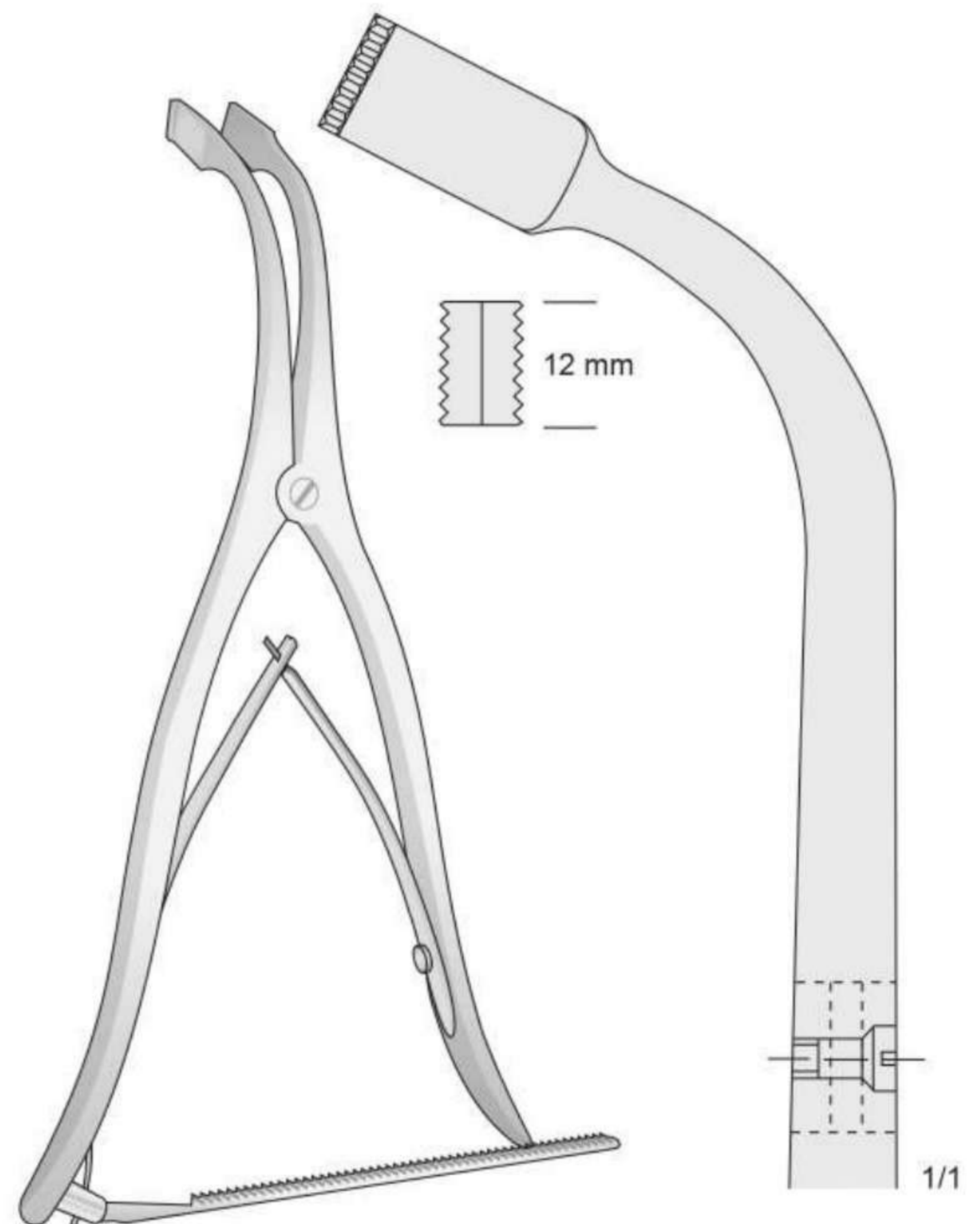

INGE
BV-82
275 mm

Nervhaken

Nerve Retractors

Divaricatori di nervi

Ganchos para nervios

Crochets à nerfs

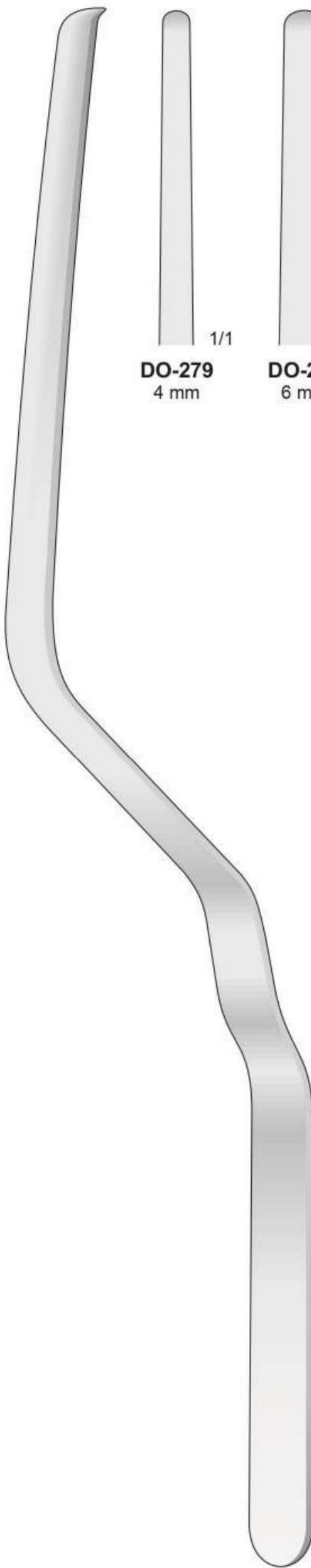

DO-279/DO-282
240 mm

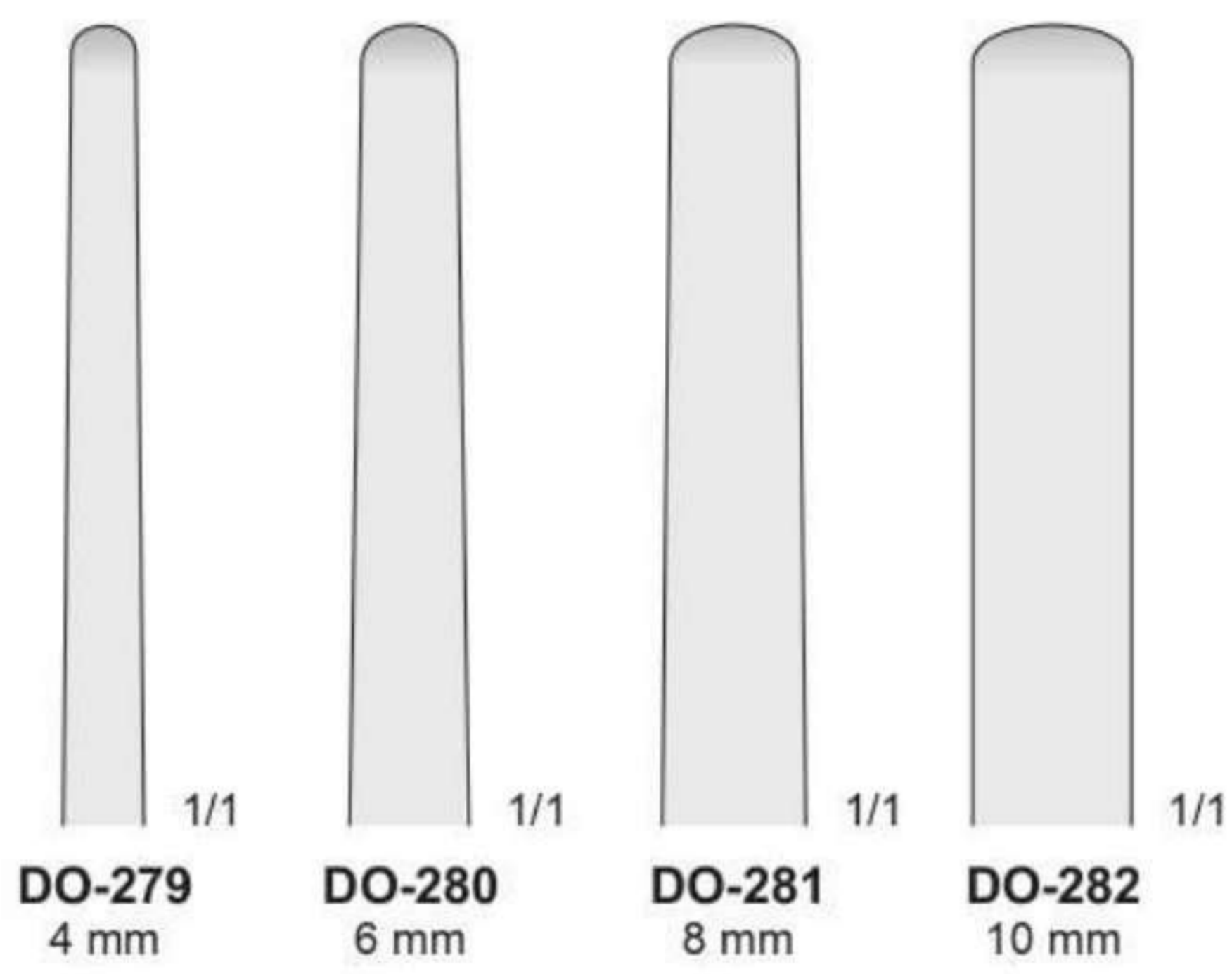

DO-279 4 mm
DO-280 6 mm
DO-281 8 mm
DO-282 10 mm

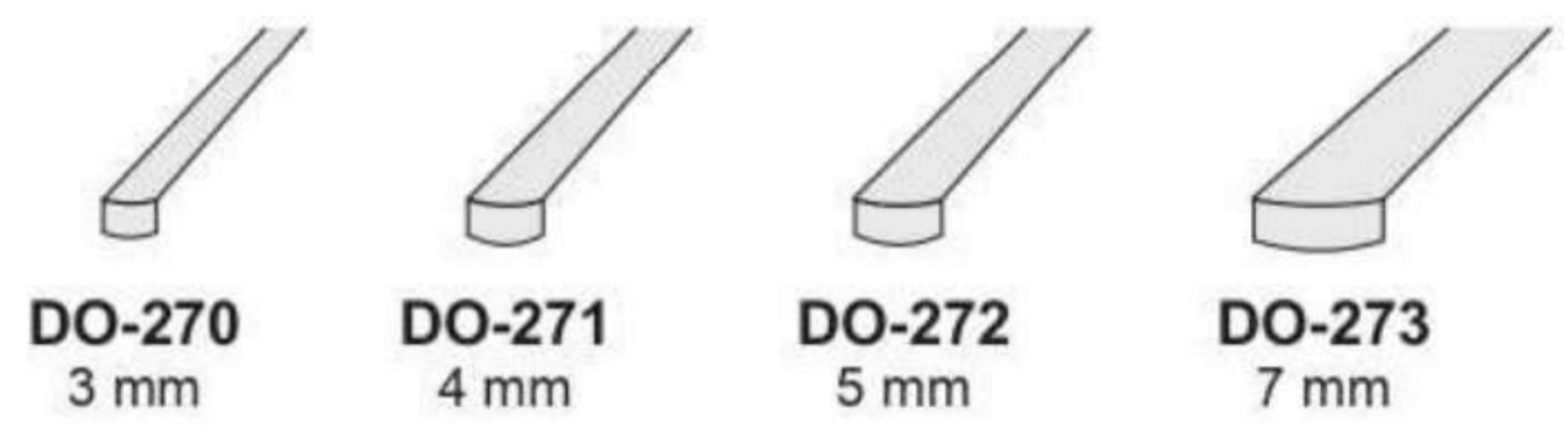

DO-270 3 mm
DO-271 4 mm
DO-272 5 mm
DO-273 7 mm

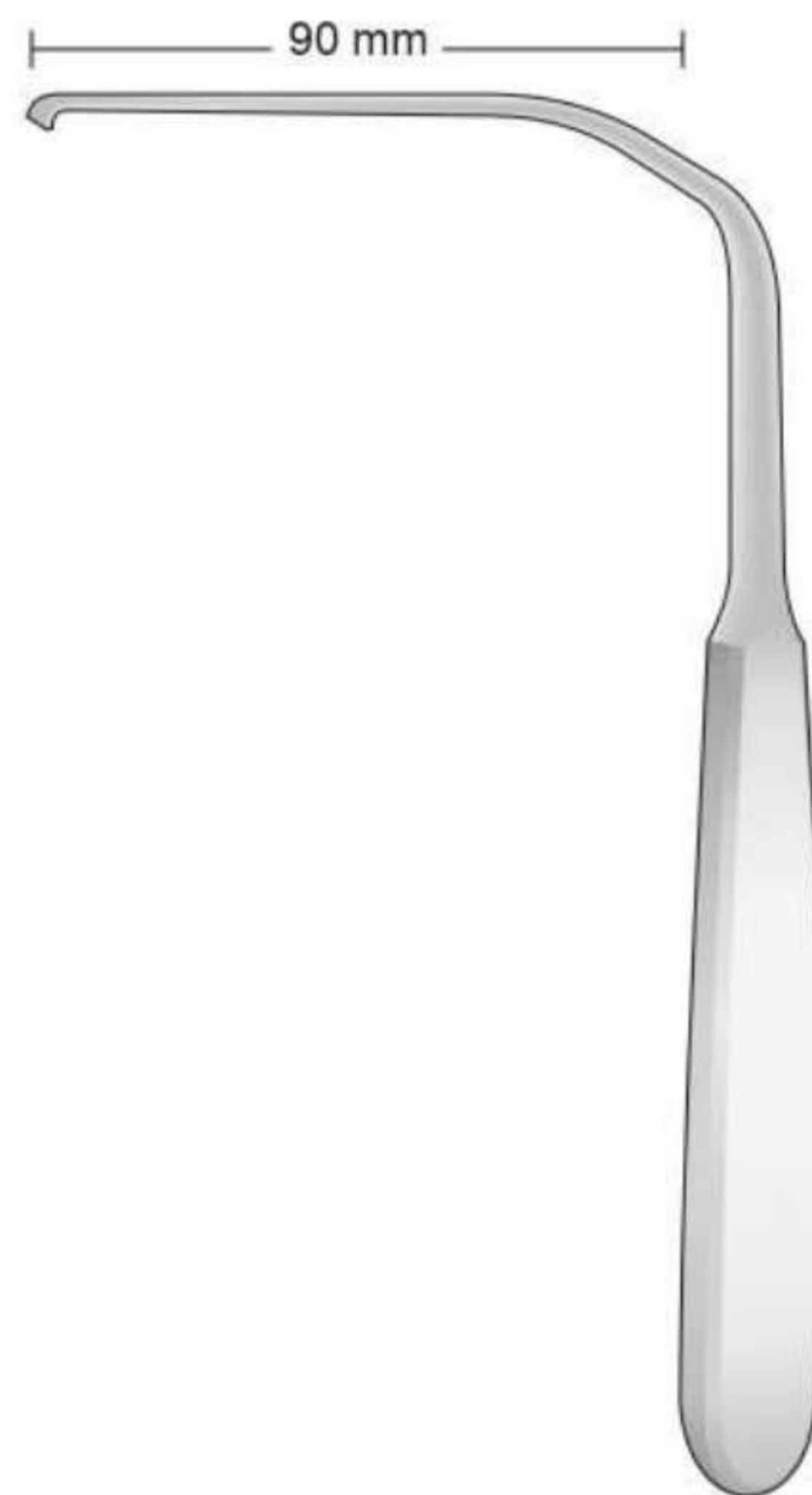

HESS
DO-270/DO-273
175 mm

Nervhaken

Nerve Hooks

Uncini per nervi

Ganchos para nervios

Crochets à nerfs

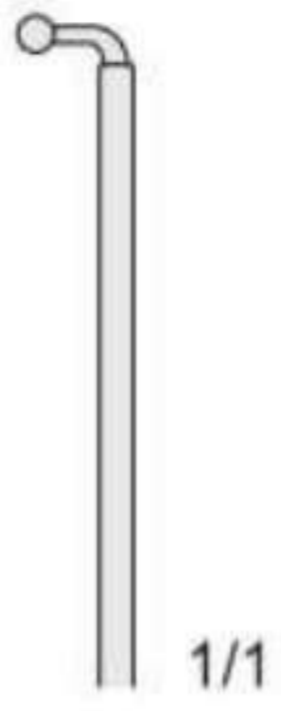

BT-300

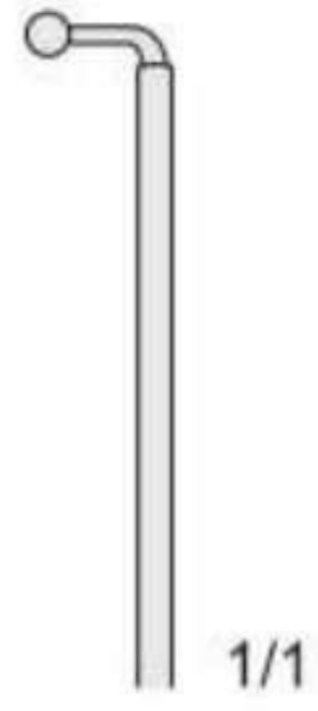

BT-301

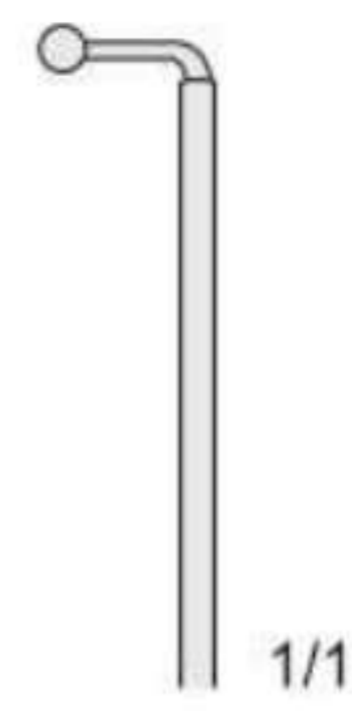

BT-302

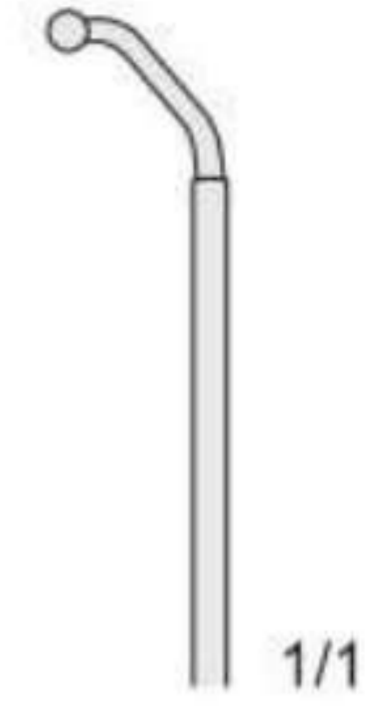

BT-303



CASPAR
BT-300/BT-303
245 mm



FF-301/FD-308

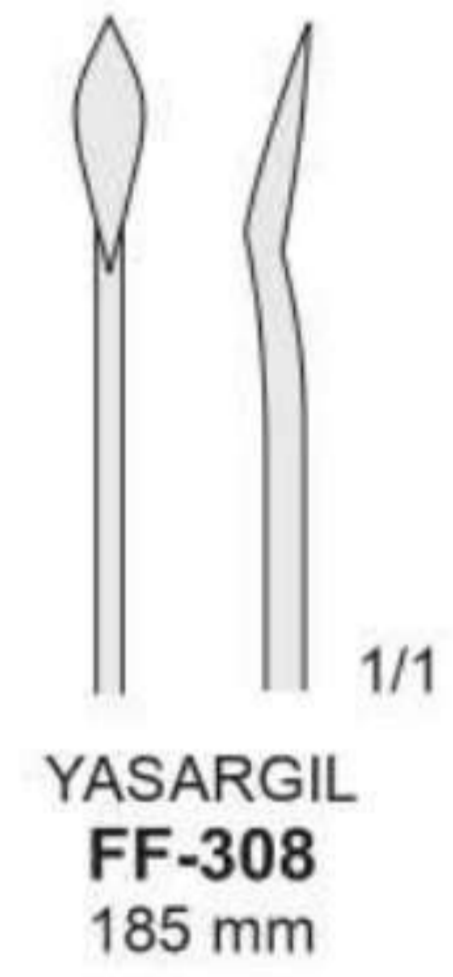
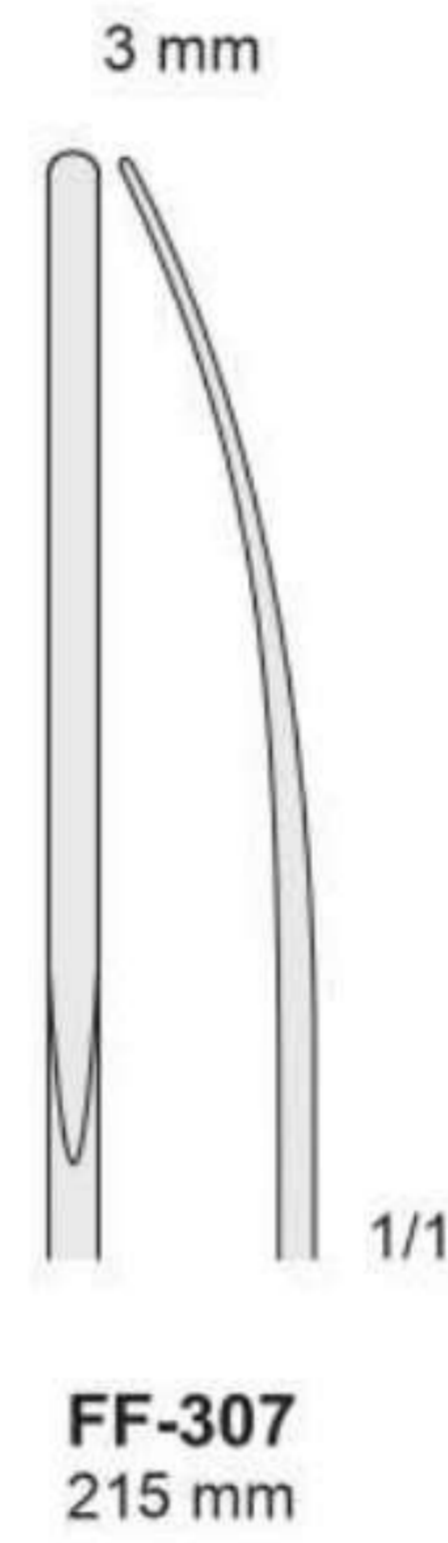
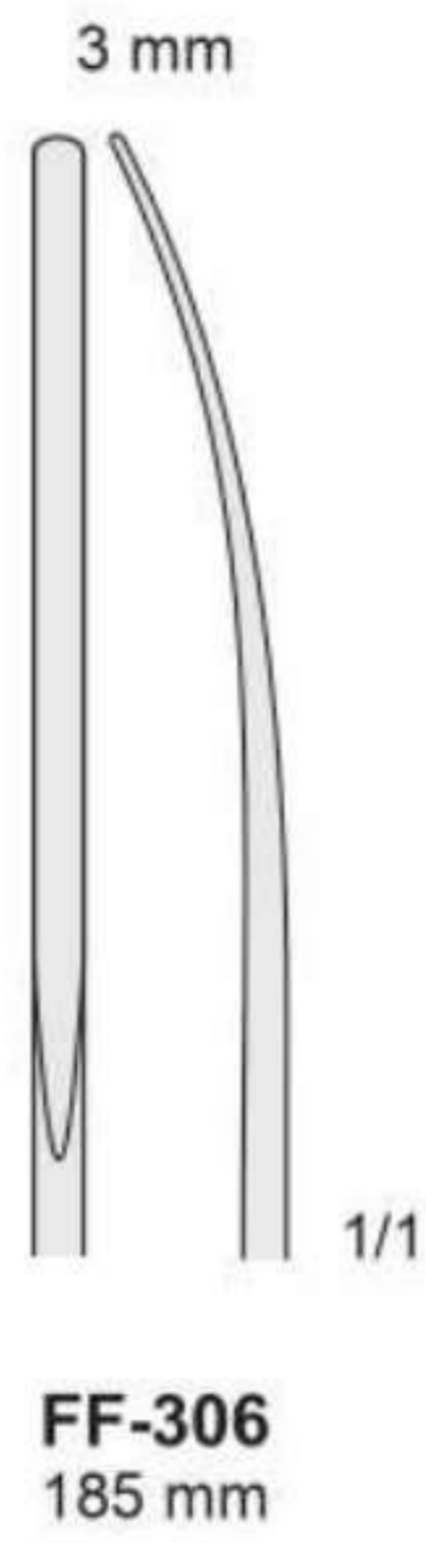
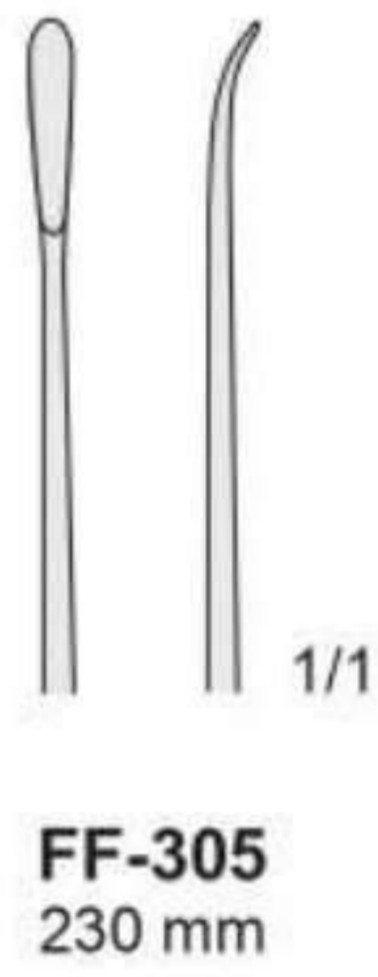
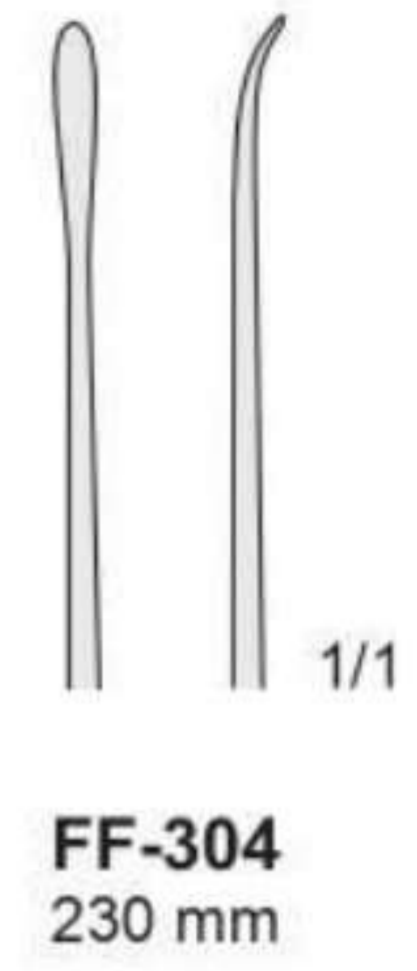
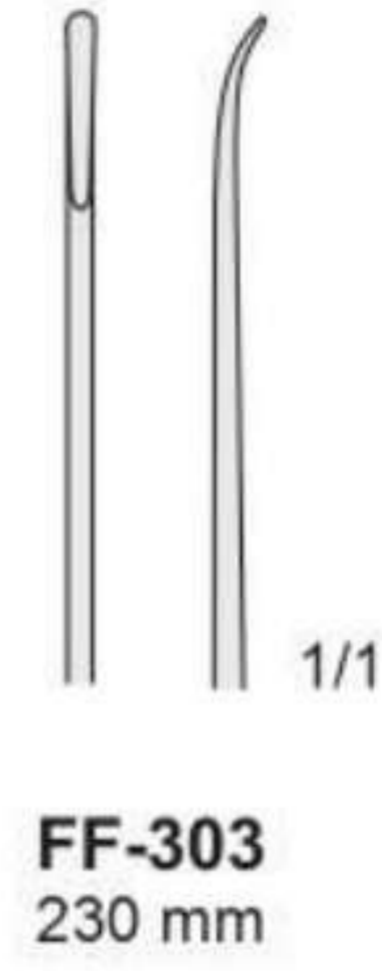
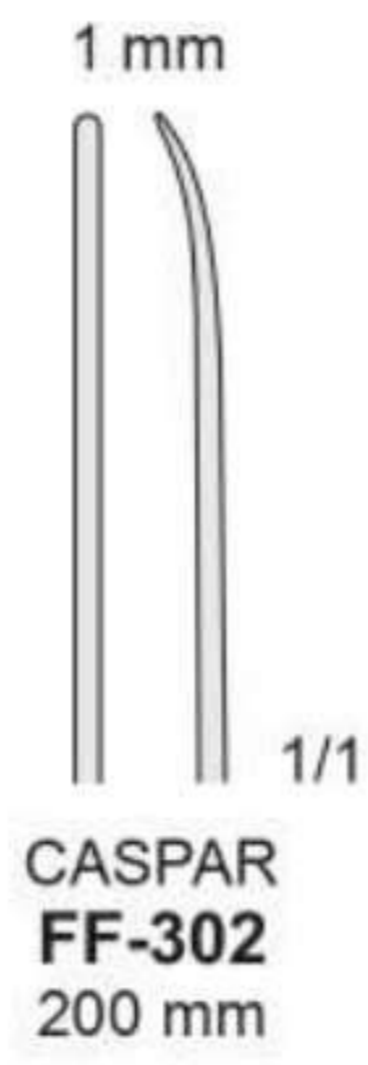
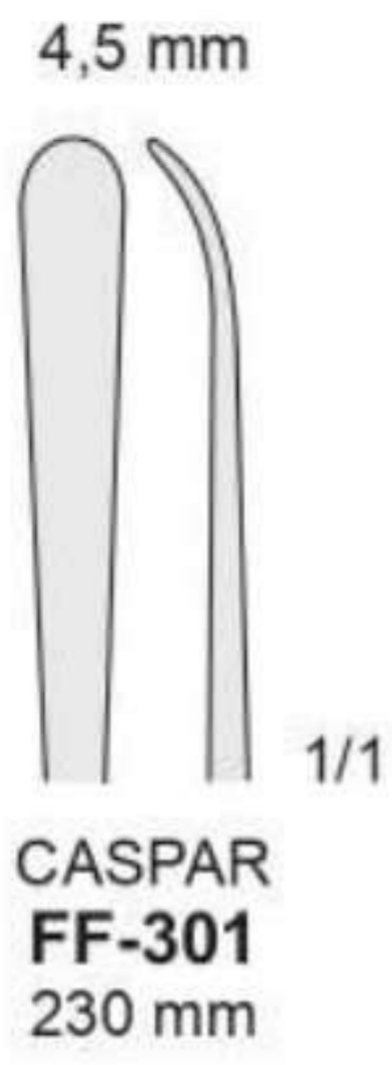

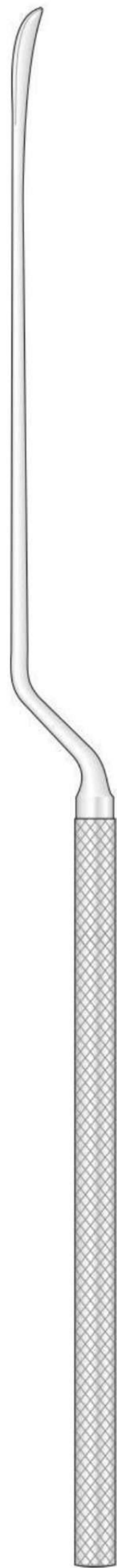

FD-309/FD-314

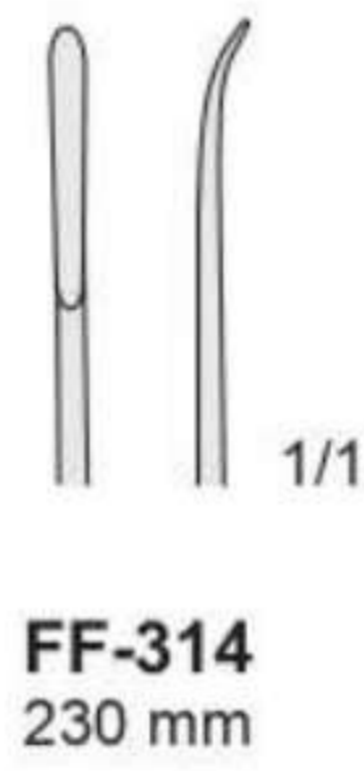
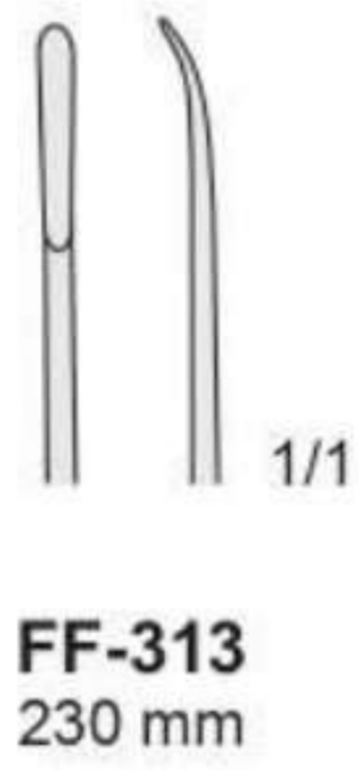
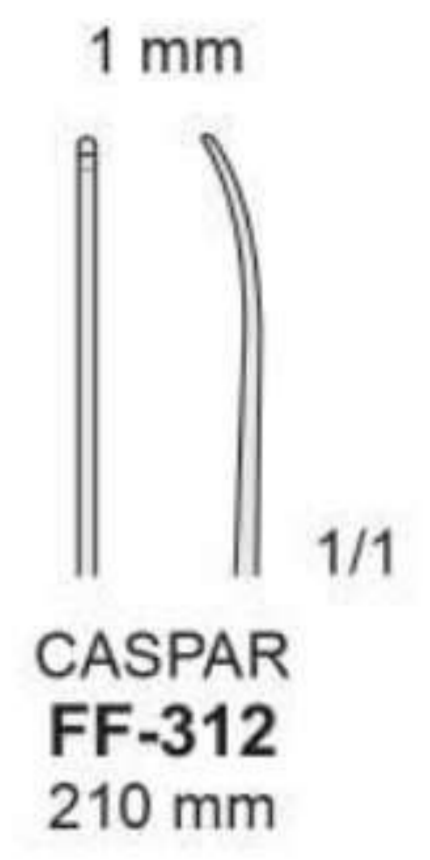
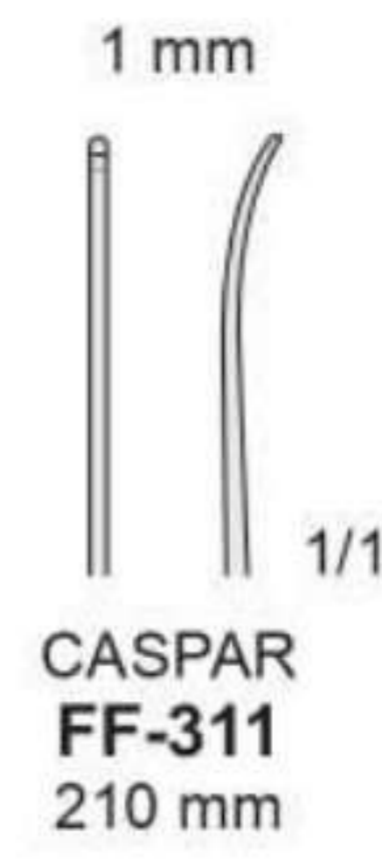
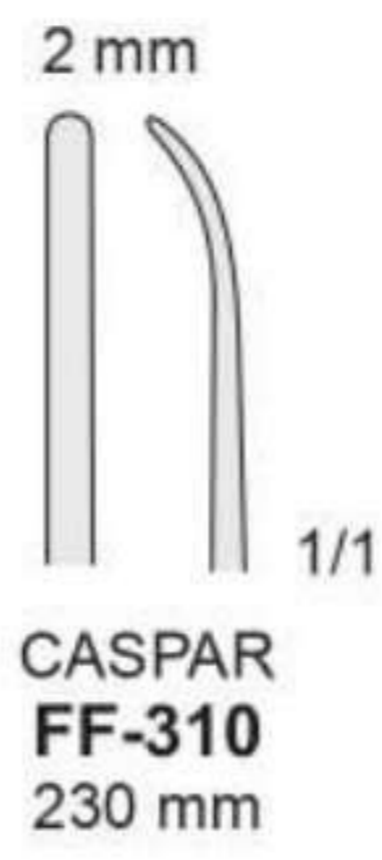
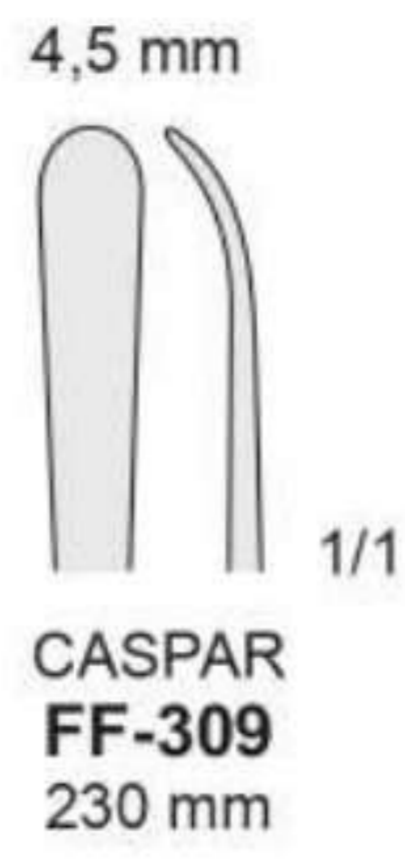

Retraktoren

Retractors

Divaricatori

Separadores

Écarteurs

Diritto



LOVE
DO-56
210 mm

45°

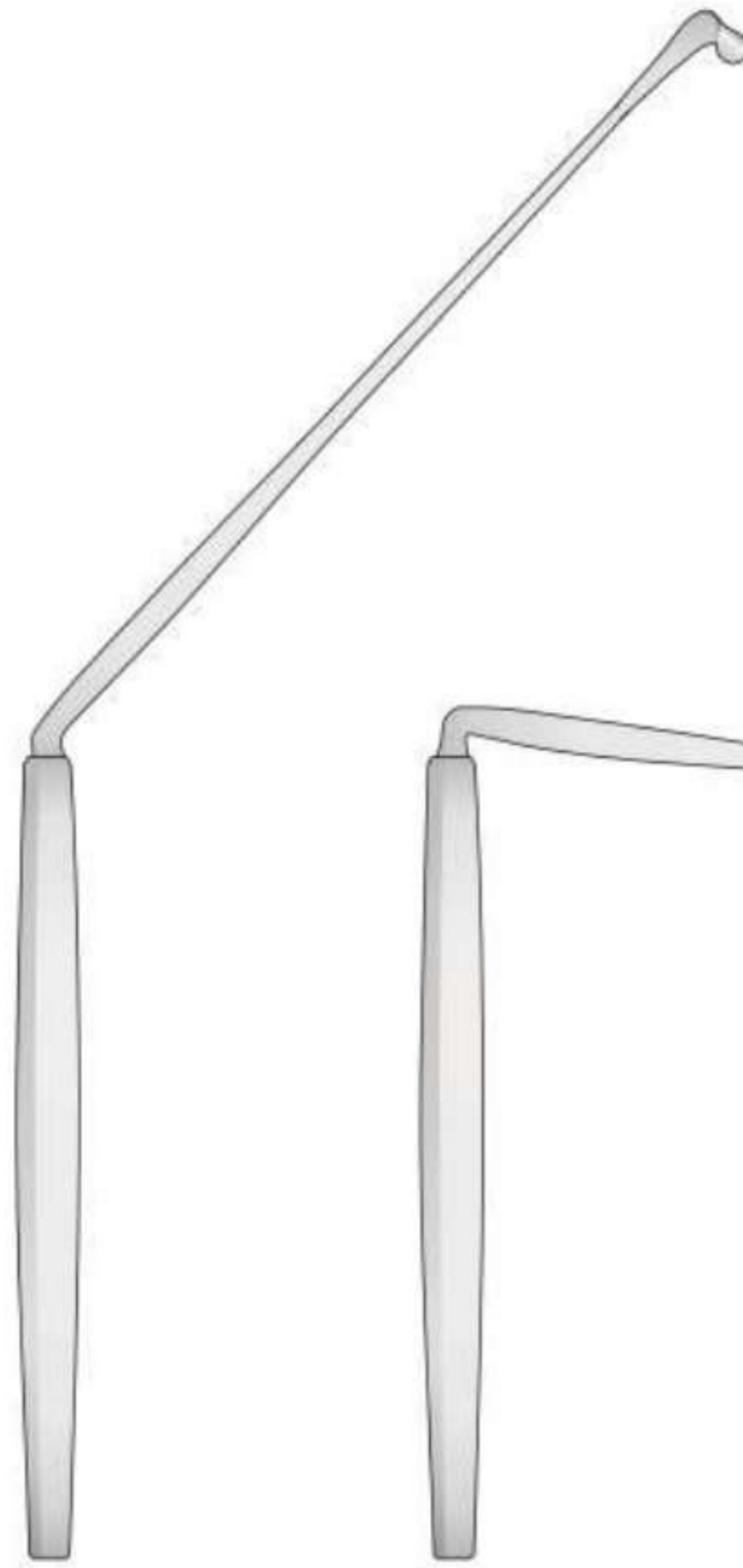

LOVE
DO-57

90°

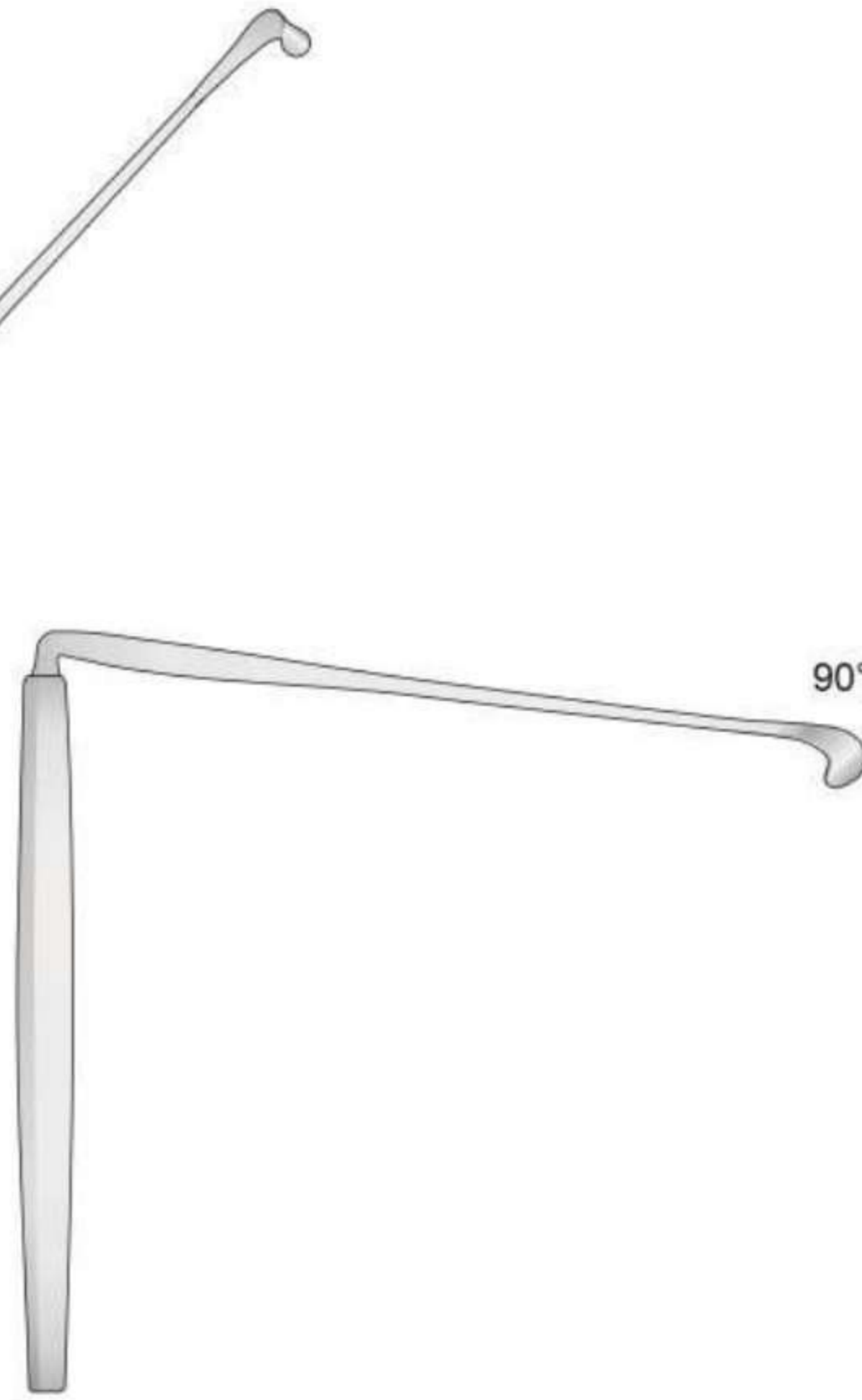

LOVE
DO-58



LOVE
DO-213 - 18 mm
DO-214 - 20 mm
DO-215 - 22 mm
150 mm



LOVE
DO-174
210 mm



1/1



TRS INSTRUMENTS

TRAUMATOLOGY AND ORTHOPAEDICS

Suction Tubes

Saugkanülen
Canules d'aspiration
Cánulas de aspiración
Cannule per aspirazione

Laminectomy

Laminektomie
Laminectomia
Laminectomía
Laminectomia

Extension Bows

Extensionsbügel
Étriers d'extension
Arcos de tracción
Archi da trazione

Knives

Messer
Couteaux
Cuchillos
Coltelli

Bone files

Knochenfeilen
Limes à os
Limas para hueso
Lime per osso

Scalpel Blades and Handles

Skalpellsklingen und Skalpellsgriffe
Lames et manches de bistouris
Hojas y mangos de bisturí
Lame e manici per bisturi

Saugkanülen

Suctions Tubes

Cannule per aspirazione

Cánulas de aspiración

Canules d'aspiration

Char. 6	=	2 mm
Char 7	=	2,5 mm
Char 8	=	2,7 mm
Char 9	=	3 mm
Char 10	=	3,3 mm
Char 12	=	4 mm
Char 15	=	5 mm

Isoliert



FERGUSSON
GF-140 Ch. 6 2,0 mm
GF-141 Ch. 7 2,5 mm
GF-142 Ch. 9 3,0 mm
GF-142B Ch. 10 3,3 mm
GF-143 Ch. 12 4,0 mm
GF-144 Ch. 15 5,0 mm
 180 mm

FRAZIER
GF-240 Ch. 6 2,0 mm
GF-241 Ch. 7 2,5 mm
GF-241B Ch. 8 2,7 mm
GF-242 Ch. 9 3,0 mm
GF-242B Ch. 10 3,3 mm
GF-243 Ch. 12 4,0 mm
GF-244 Ch. 15 5,0 mm
 180 mm

FRAZIER
GF-252 Ch. 12
 180 mm

PLESTER
GF-150 Ch. 6 2,0 mm
GF-151 Ch. 7 2,5 mm
GF-151B Ch. 8 2,7 mm
GF-152 Ch. 9 3,0 mm
GF-152B Ch. 10 3,3 mm
GF-153 Ch. 12 4,0 mm
GF-154 Ch. 15 5,0 mm
 200 mm

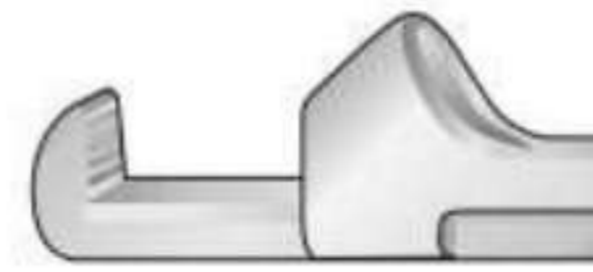

1,5 mm

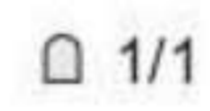

DB-177

2,0 mm



DB-178

2,2 mm



DB-179

2,5 mm



DB-180

3,0 mm



DB-181

3,5 mm



DB-182

4,0 mm



DB-183

Punches - Stanzen



- DB-177** 1,5 mm
- DB-178** 2,0 mm
- DB-179** 2,2 mm
- DB-180** 2,5 mm
- DB-181** 3,0 mm
- DB-182** 3,5 mm
- DB-183** 4,0 mm

CITELLI
DB-177/DB-183

Punches - Stanzen

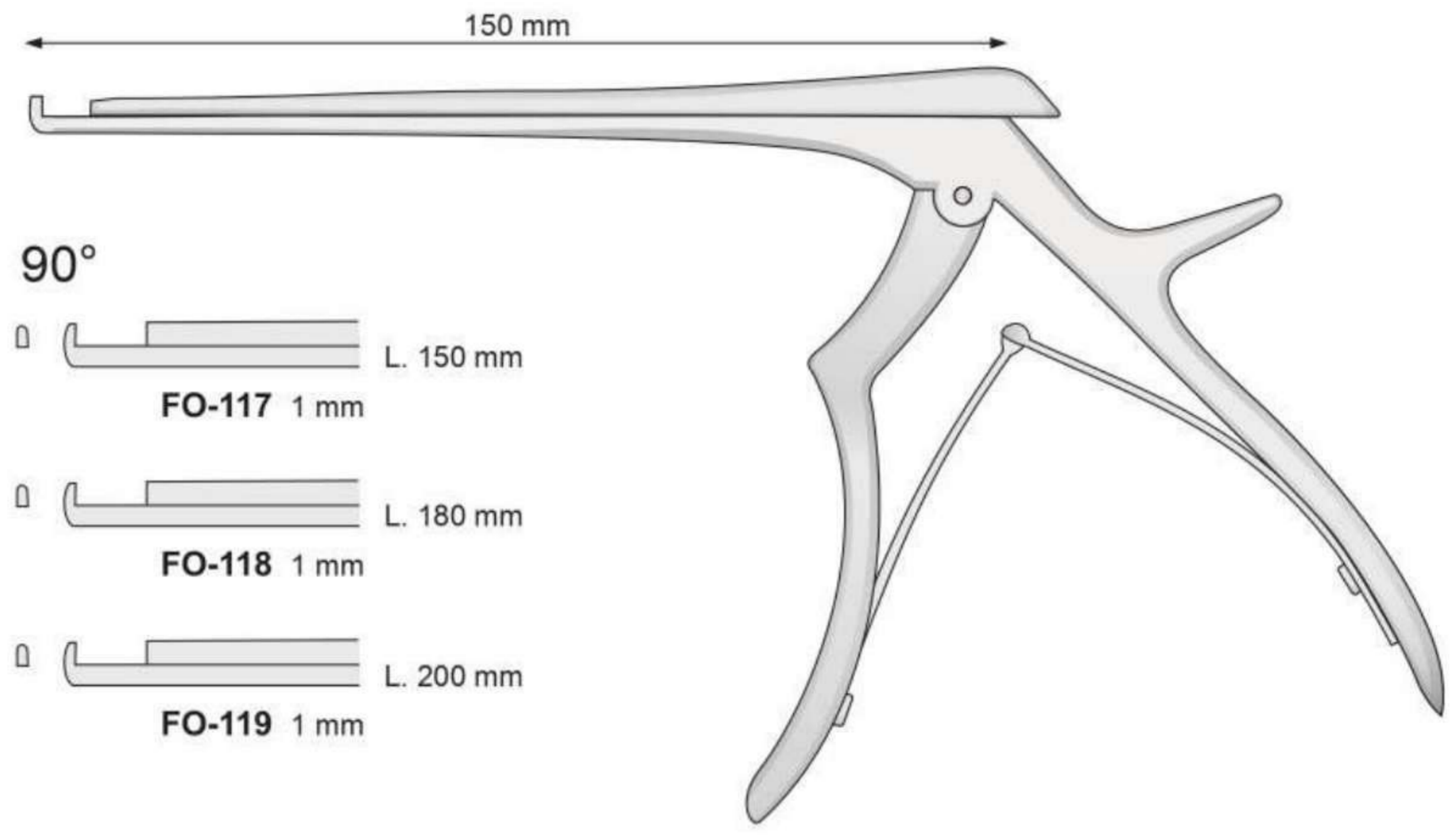

FERRIS-SMITH-KERRISON
FO-117/FO-119

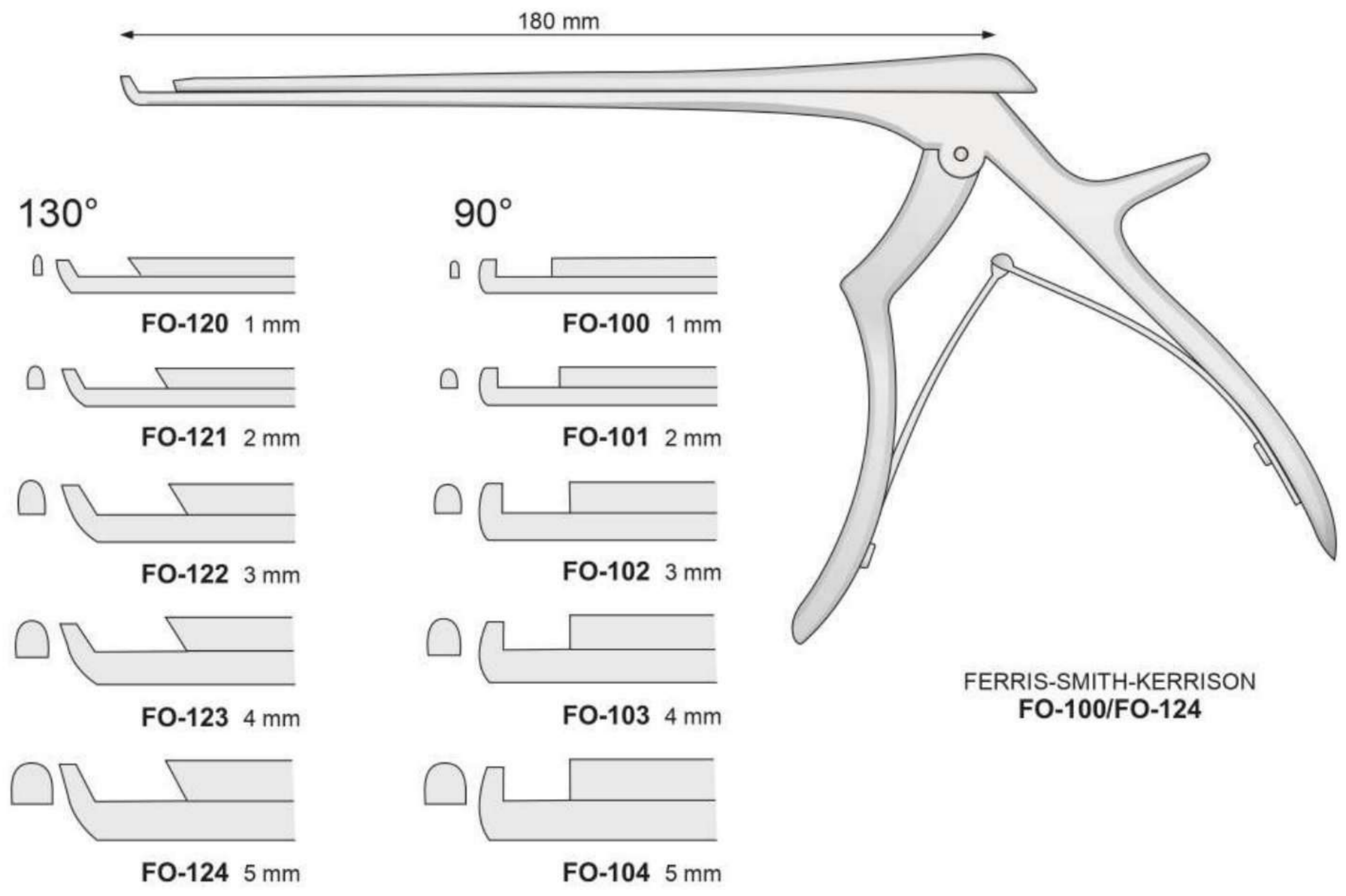

FERRIS-SMITH-KERRISON
FO-100/FO-124

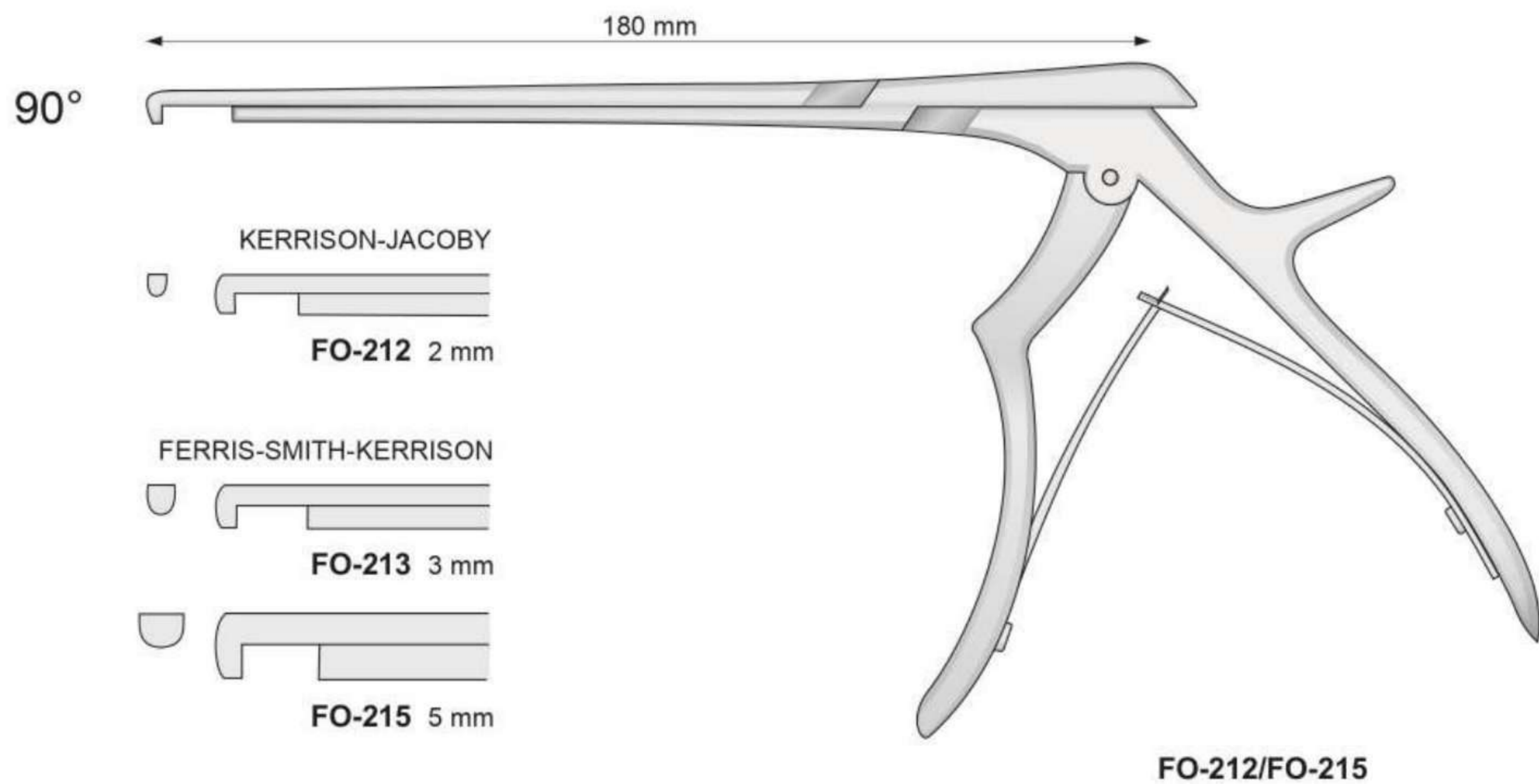
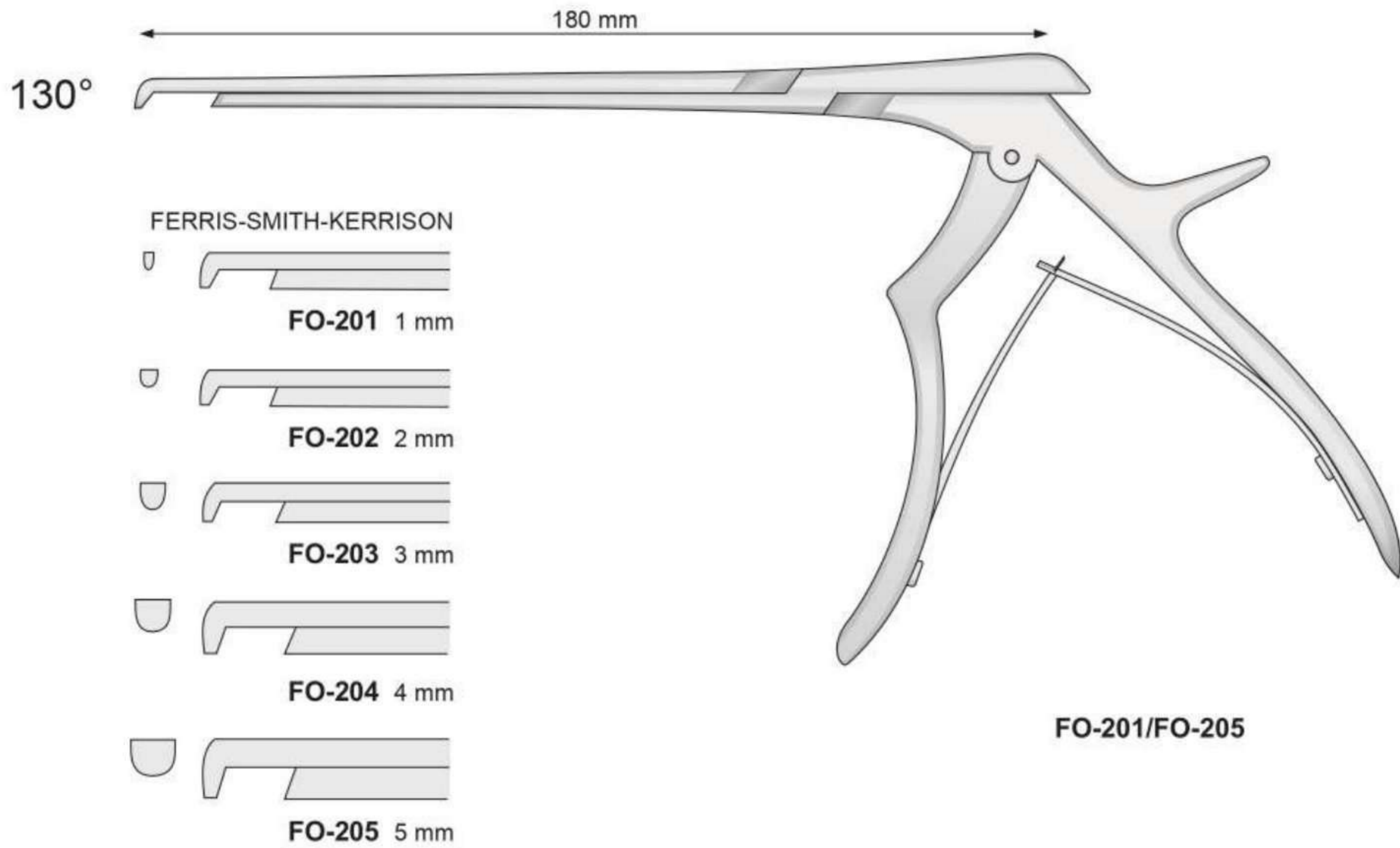

Laminektomie

Laminectomy

Laminectomia

Laminectomía

Laminectomie

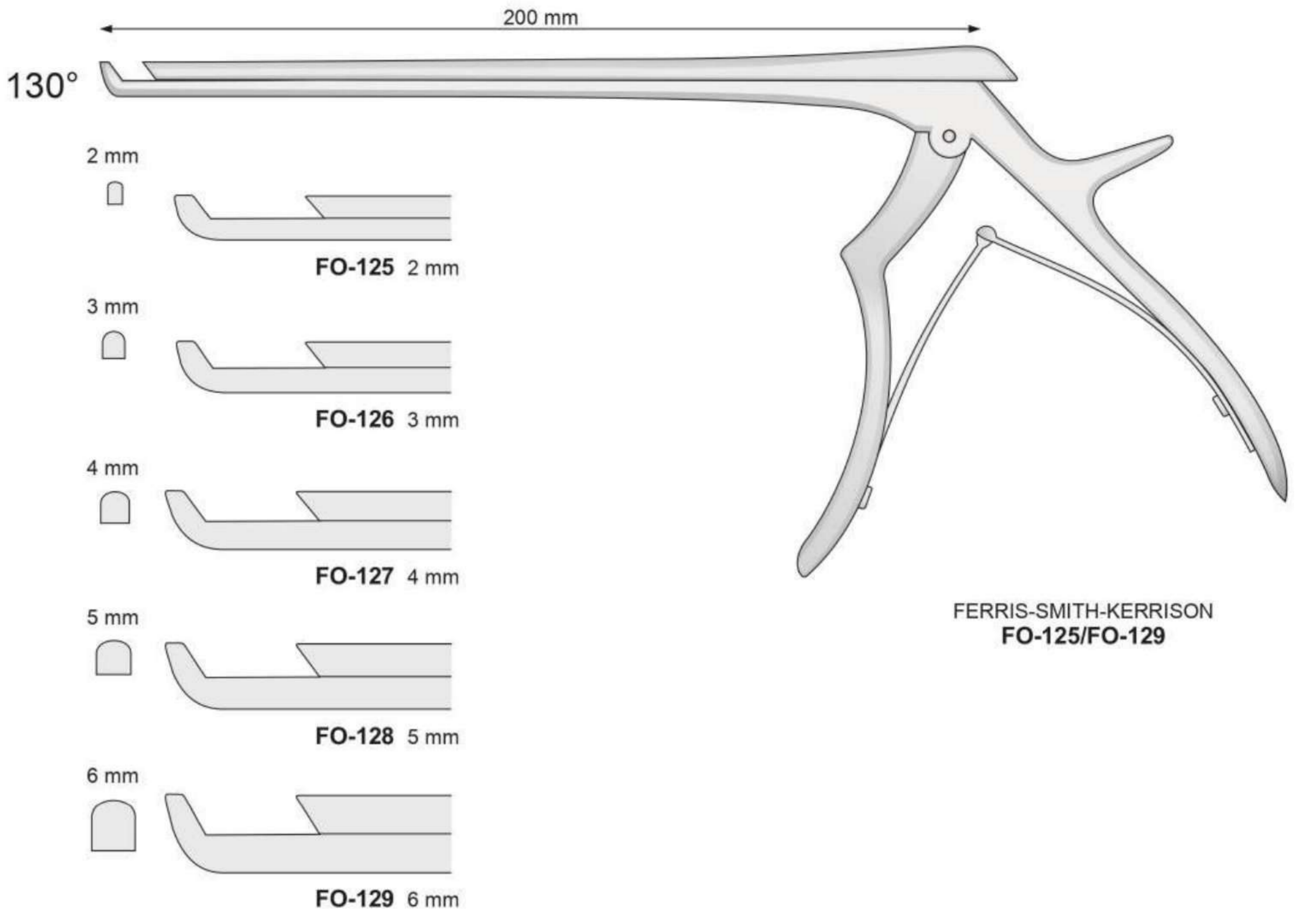

Laminotomo cervicale - Cervical Laminectomy

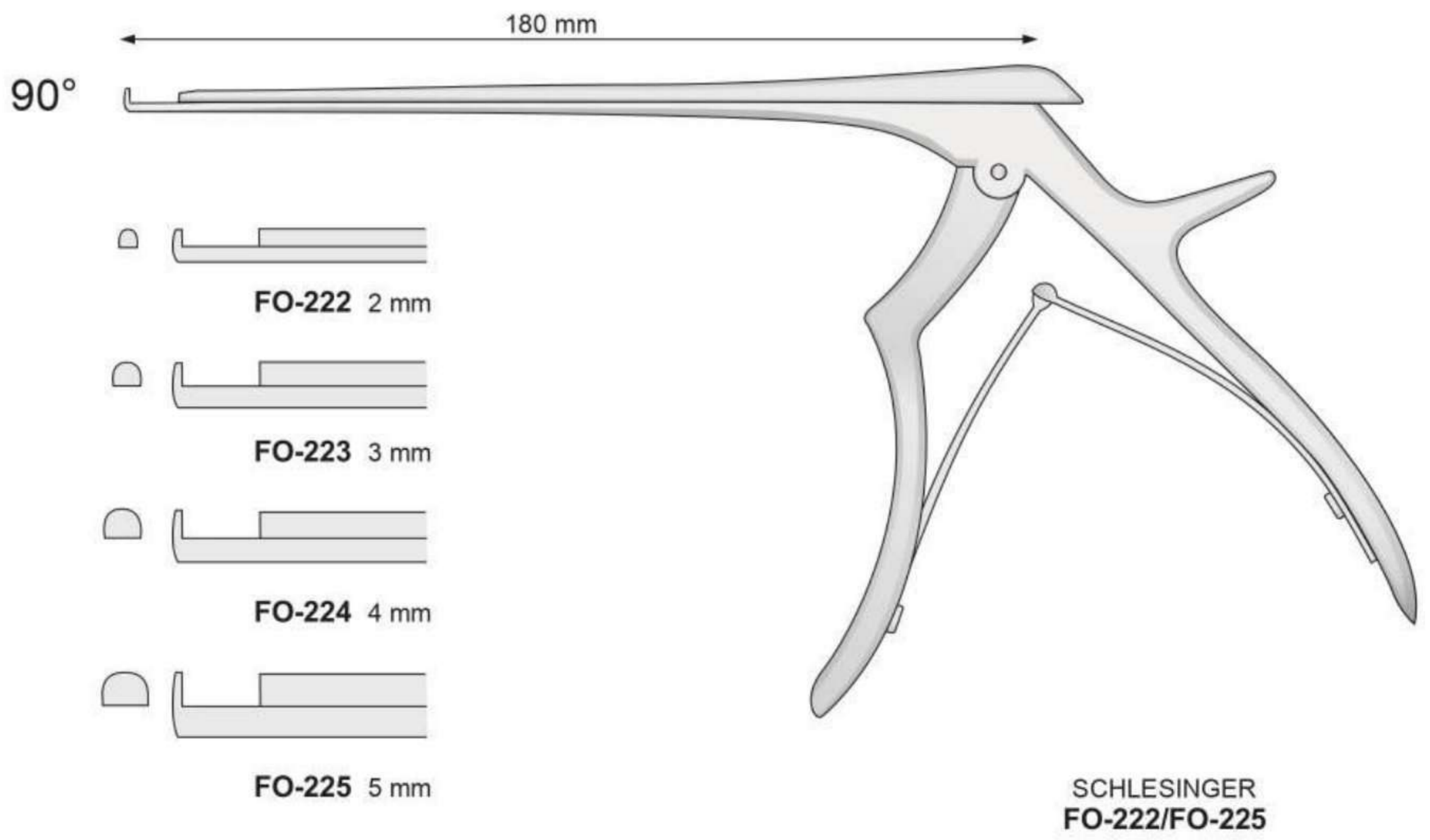

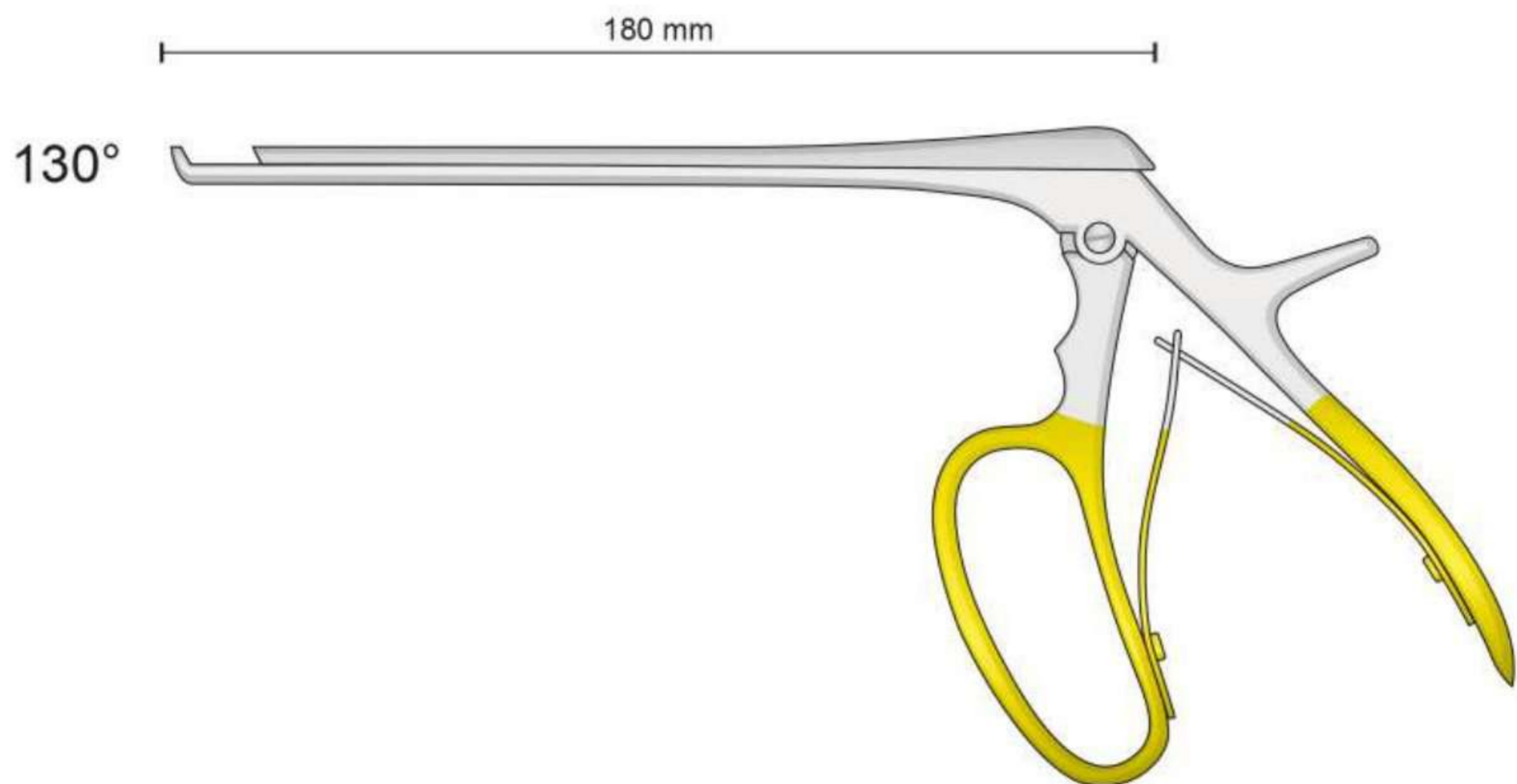

FERRIS - SMITH - KERRISON
FO-171/FO-175

Gerade
Straight
Diritta
Rectas
Droites



	FO-180	2 x 10 mm
	FO-181	3 x 10 mm
	FO-182	4 x 10 mm
	FO-183	6 x 12 mm

Aufwärtsgebogen
Top curved
Curva verso l'alto
Curvos
Courbe vers le haut

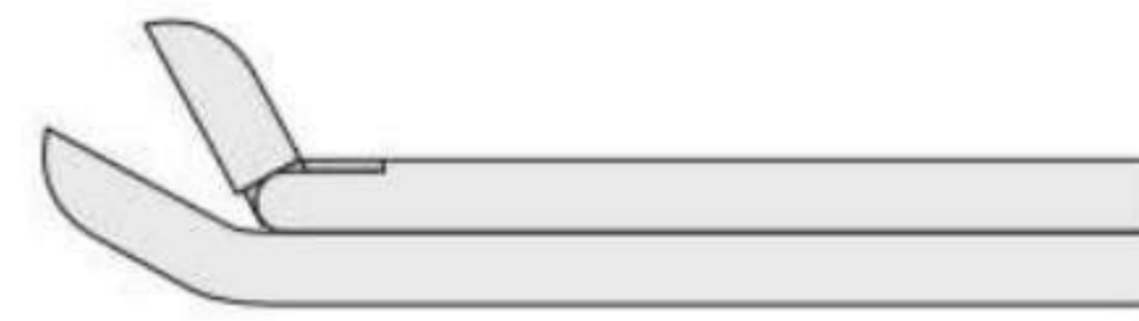

	FO-184	2 x 10 mm
	FO-185	3 x 10 mm
	FO-186	4 x 10 mm

Abwärts gebogen
Bottom curved
Curva verso il basso
Curvos
Courbe vers le bas

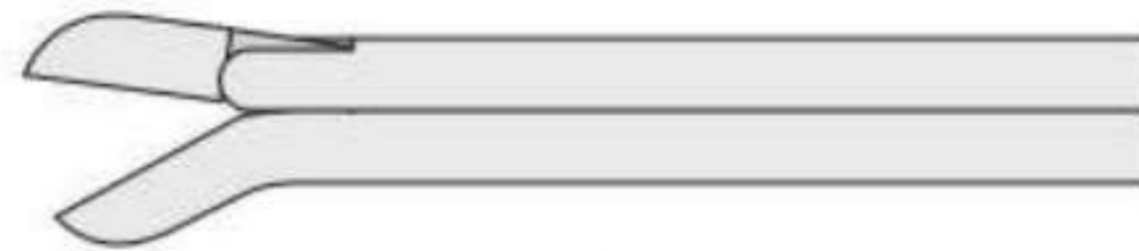

	FO-187	2 x 10 mm
	FO-188	3 x 10 mm
	FO-189	4 x 10 mm

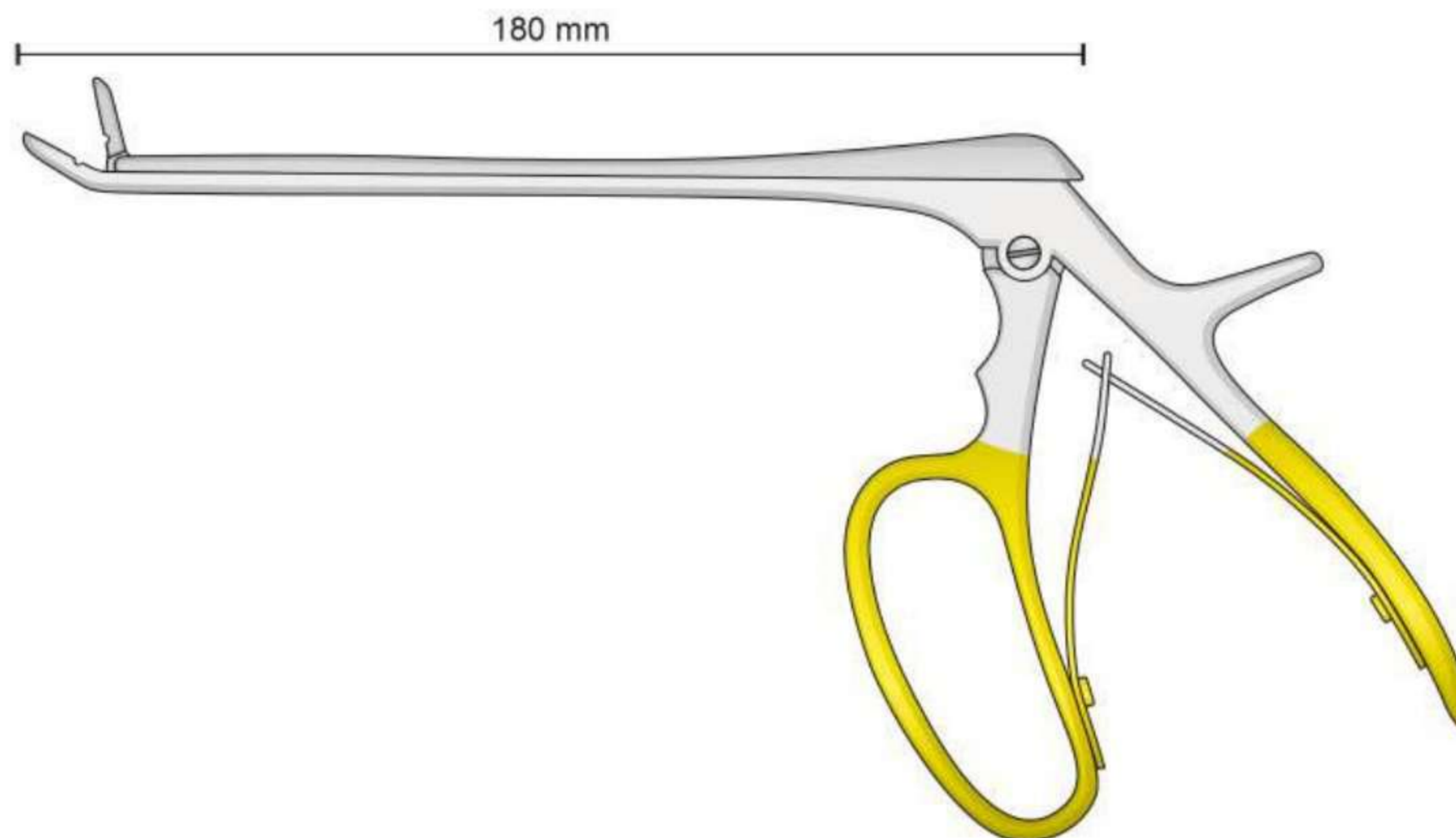

FERRIS - SMITH - CUSHING
FO-180/FO-189

Hohlmeißelzangen
für Laminektomie

Laminectomy
Rongeurs

Pinze ossivore
per laminectomia

Pinzas gubias
para laminectomia

Pinces-gouges
pour laminectomie

Gerade
Straight
Diritta
Rectas
Droites

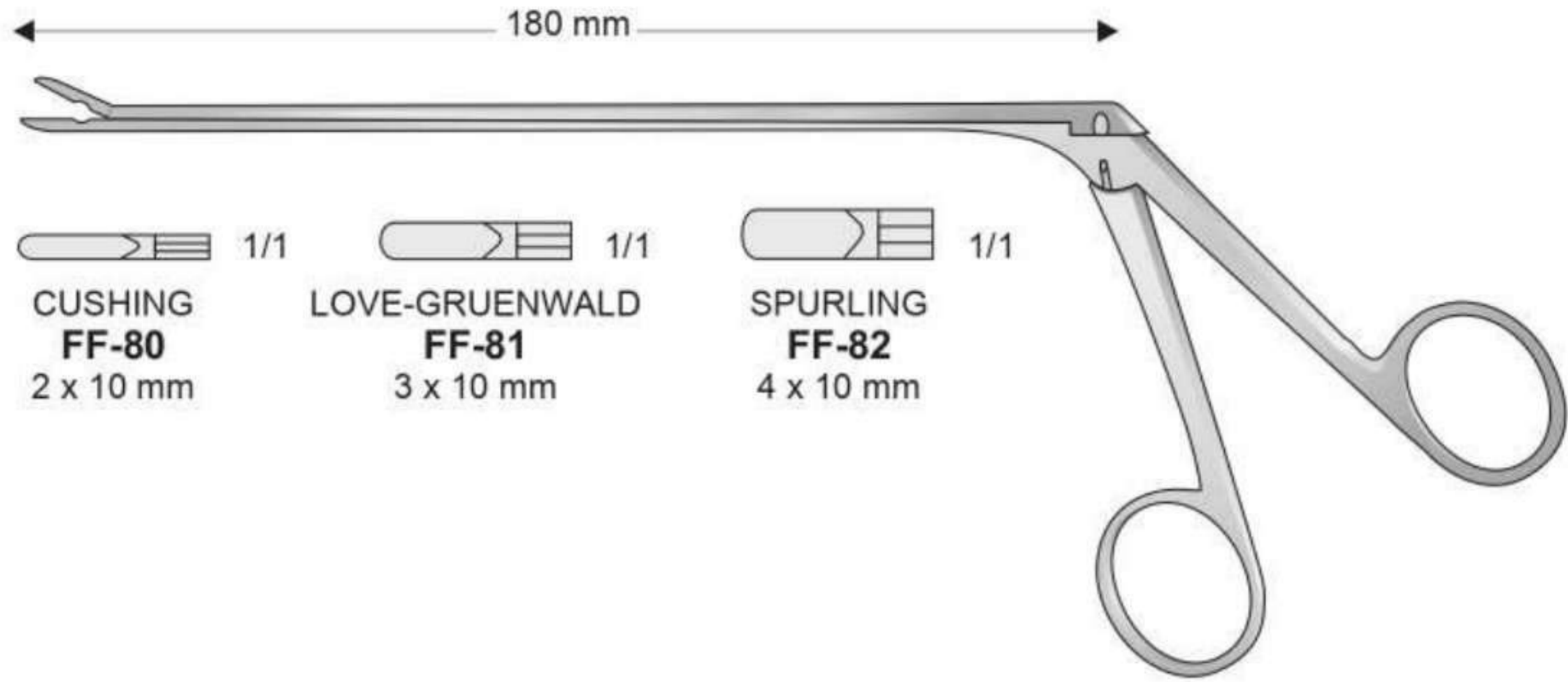

FF-80/FF-82

Aufwärtsgebogen
Top curved
Curva verso l'alto
Curvos
Courbe vers le haut

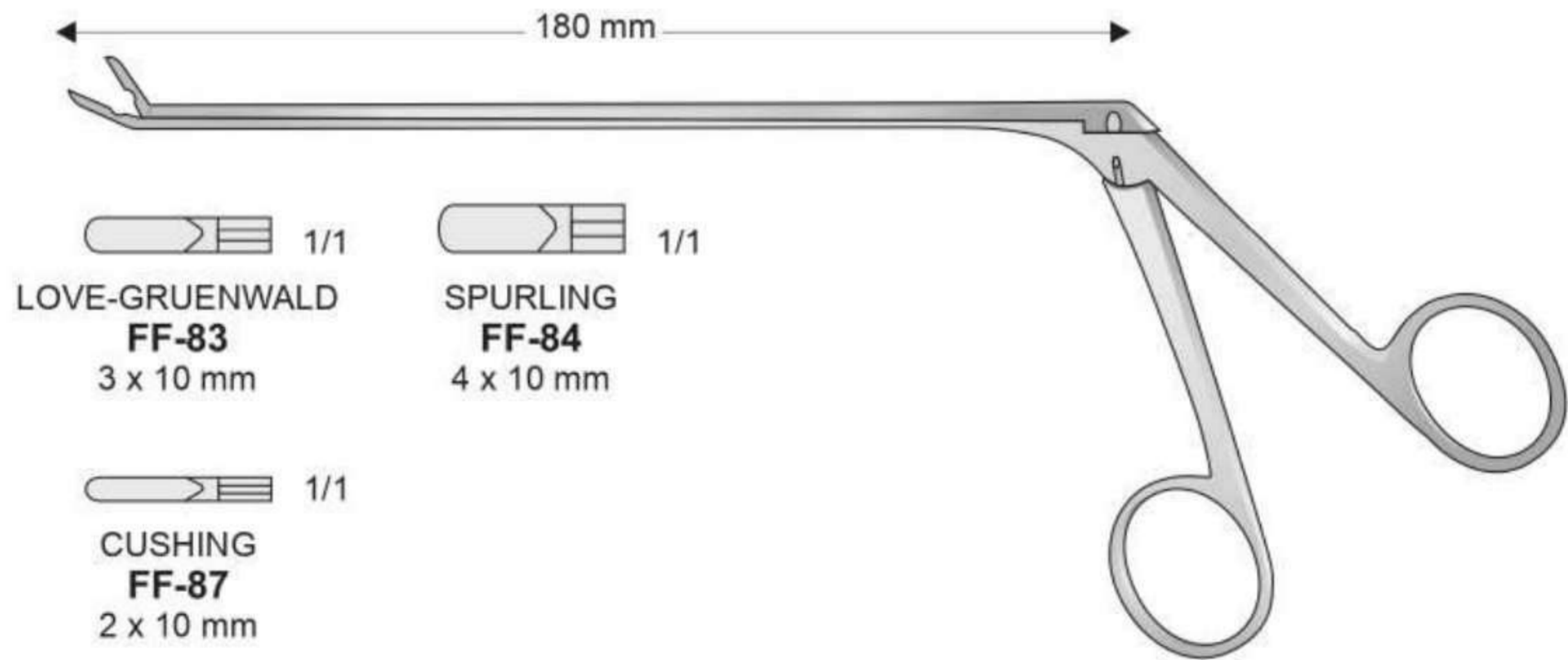

FF-83/FF-87

Abwärts gebogen
Bottom curved
Curva verso il basso
Curvos
Courbe vers le bas

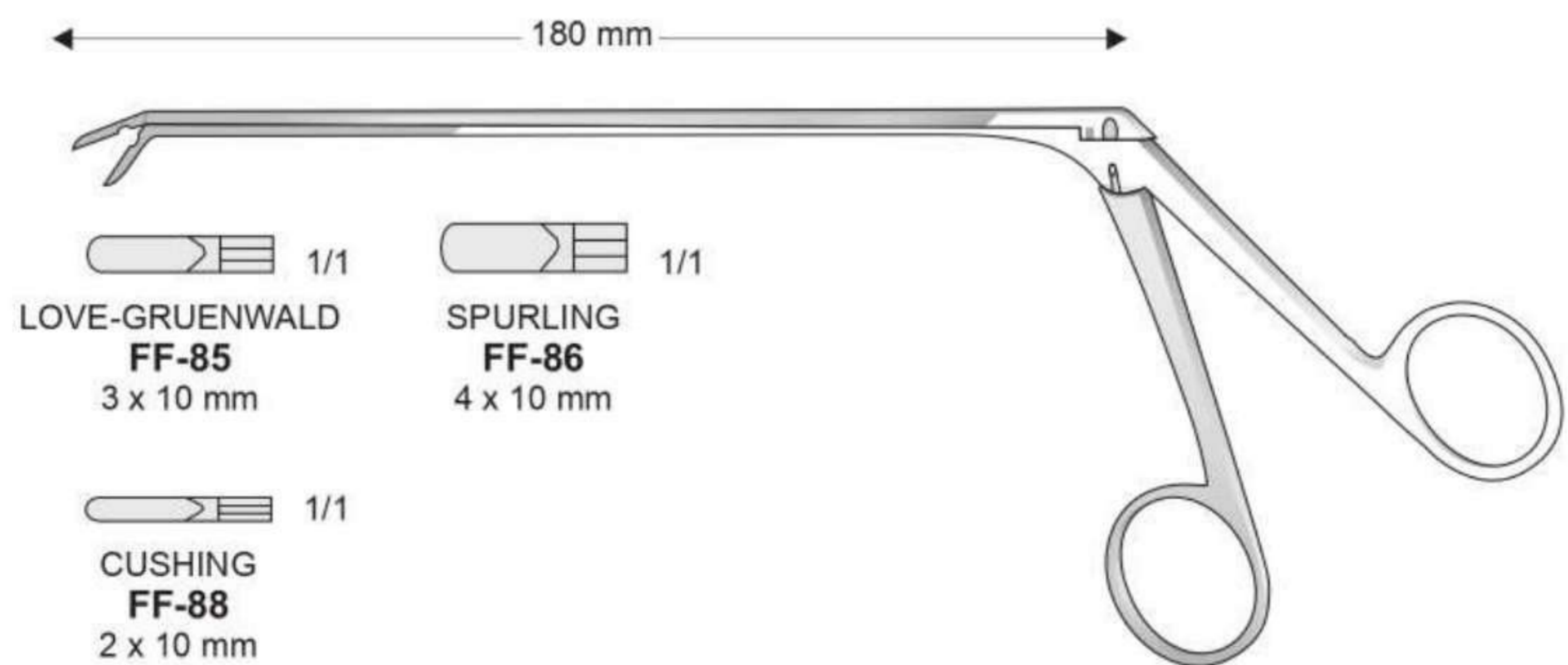

FF-85/FF-88

Hohlmeißelzangen
für Laminektomie

Laminectomy
Rongeurs

Pinze ossivore
per laminectomia

Pinzas gubias
para laminectomia

Pinces-gouges
pour laminectomie

Gerade
Straight
Diritta
Rectas
Droites

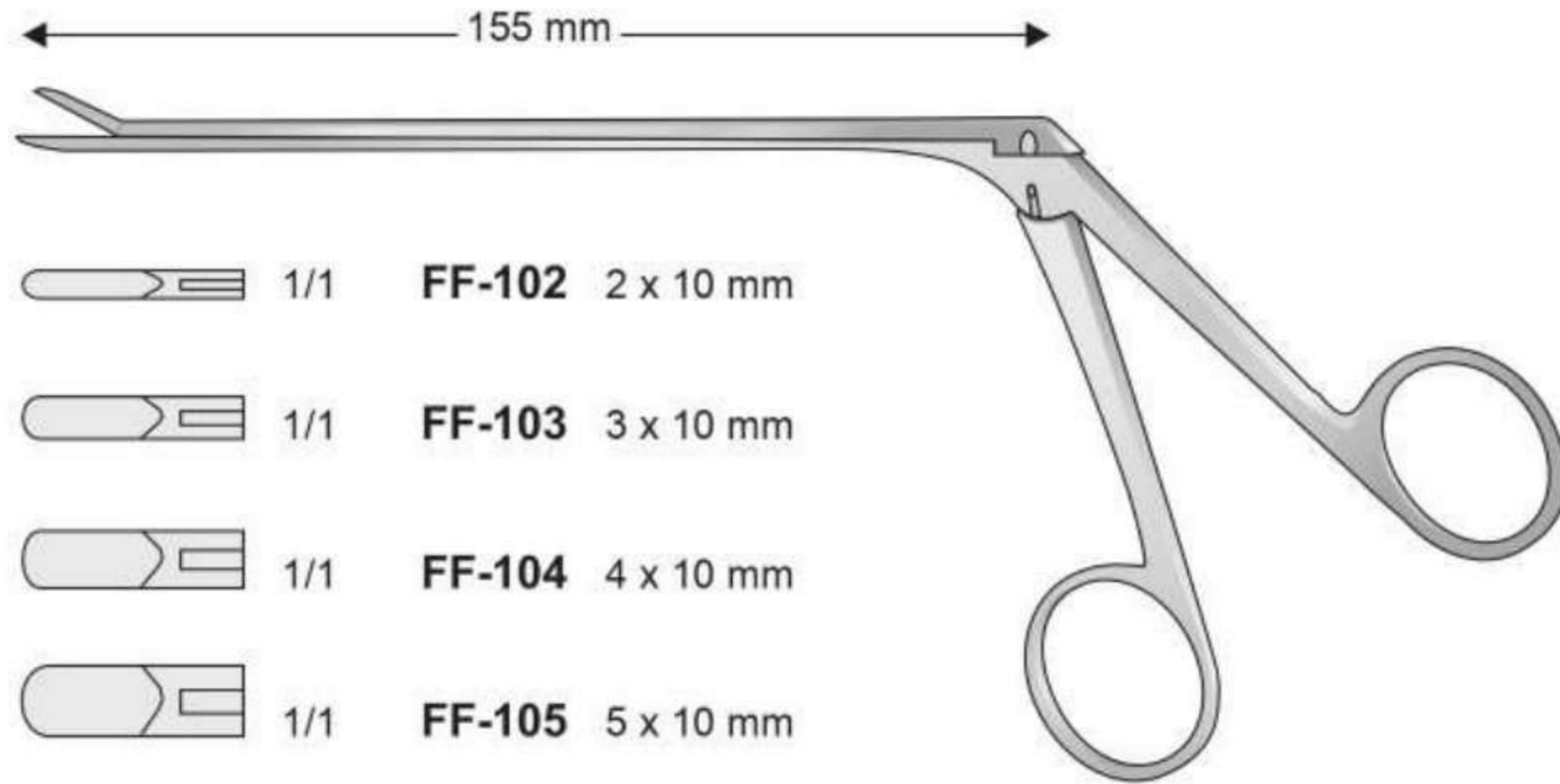

Aufwärtsgebogen
Top curved
Curva verso l'alto
Curvos
Courbe vers le haut

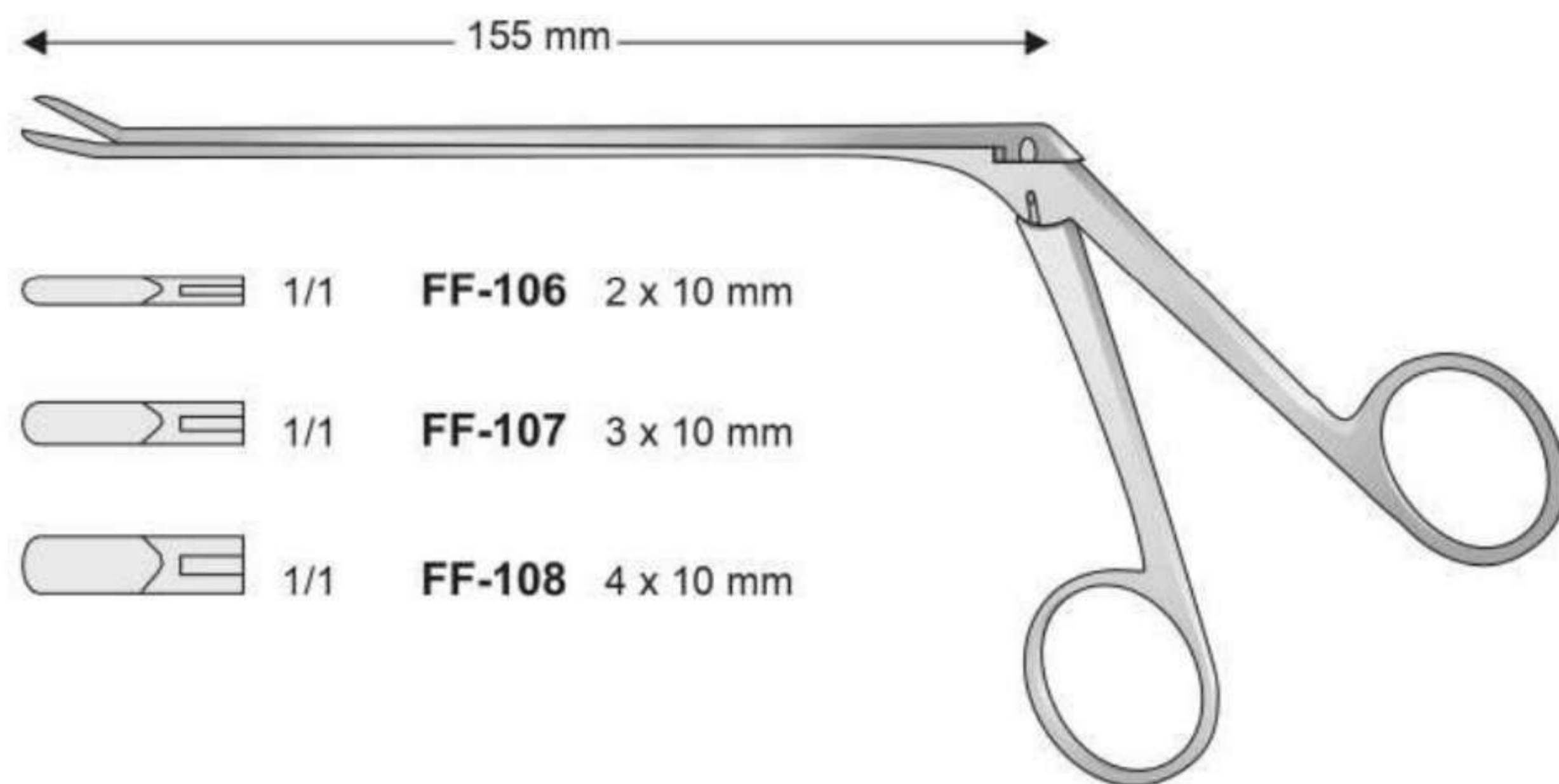

Abwärts gebogen
Bottom curved
Curva verso il basso
Curvos
Courbe vers le bas

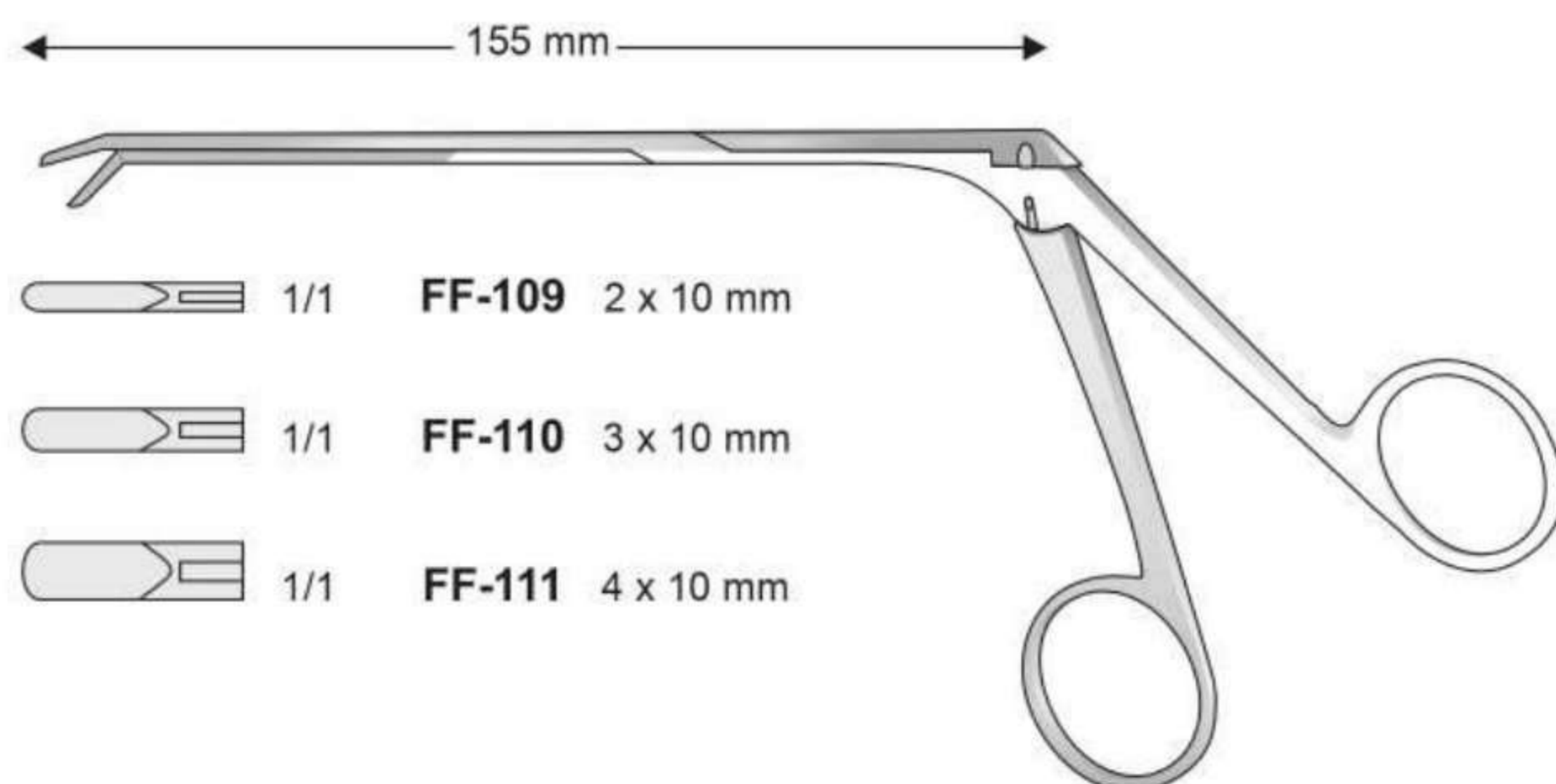

Hohlmeißelzangen
für Laminektomie

Laminectomy
Rongeurs

Pinze ossivore
per laminectomia

Pinzas gubias
para laminectomia

Pinces-gouges
pour laminectomie

Gerade
Straight
Diritta
Rectas
Droites

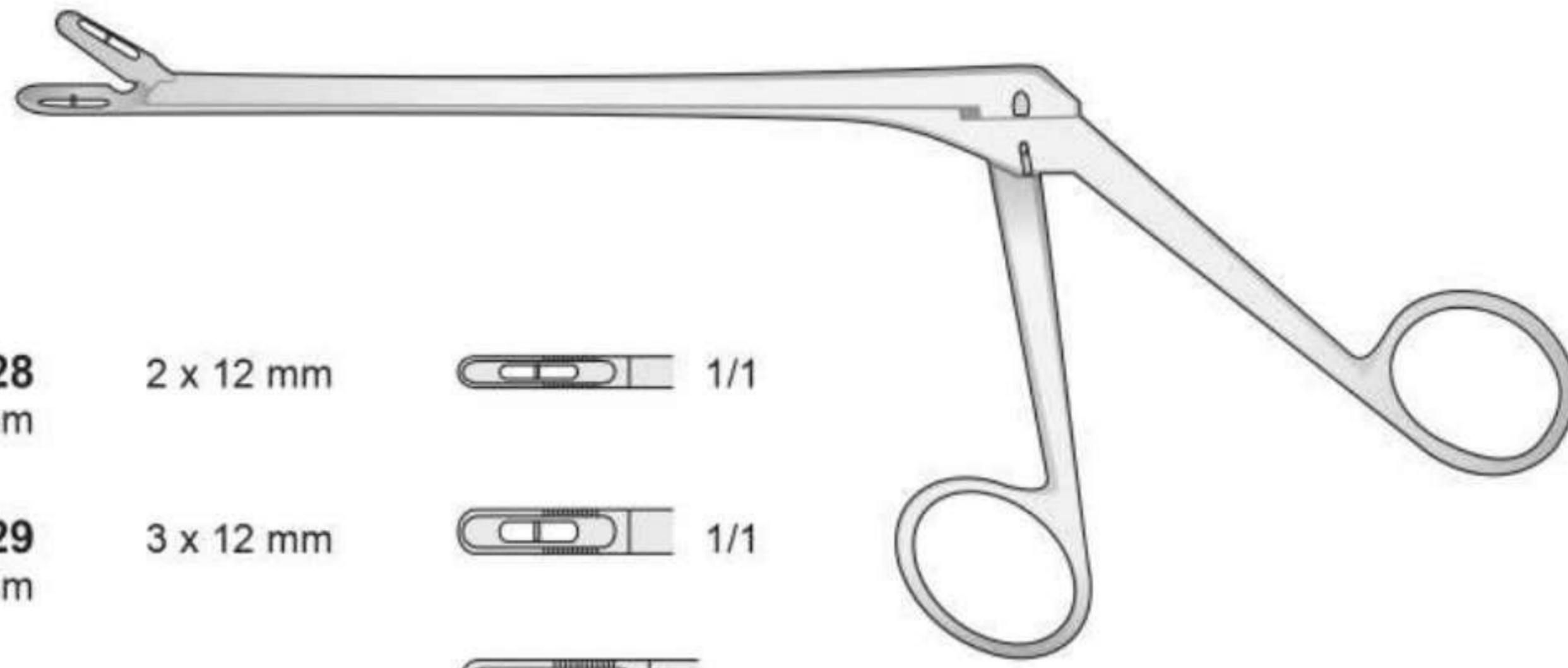

CASPAR

FF-120 140 mm	FF-123 160 mm	FF-128 185 mm	2 x 12 mm	 1/1
FF-121 140 mm	FF-124 160 mm	FF-129 185 mm	3 x 12 mm	 1/1
FF-122 140 mm	FF-125 160 mm	FF-130 185 mm	4 x 14 mm	 1/1
	FF-126 160 mm	FF-131 185 mm	5 x 14 mm	 1/1
	FF-127 160 mm	FF-132 185 mm	6 x 16 mm	 1/1

CASPAR
FF-120/FF-132

Aufwärtsgebogen
Top curved
Curva verso l'alto
Curvos
Courbe vers le haut

150°

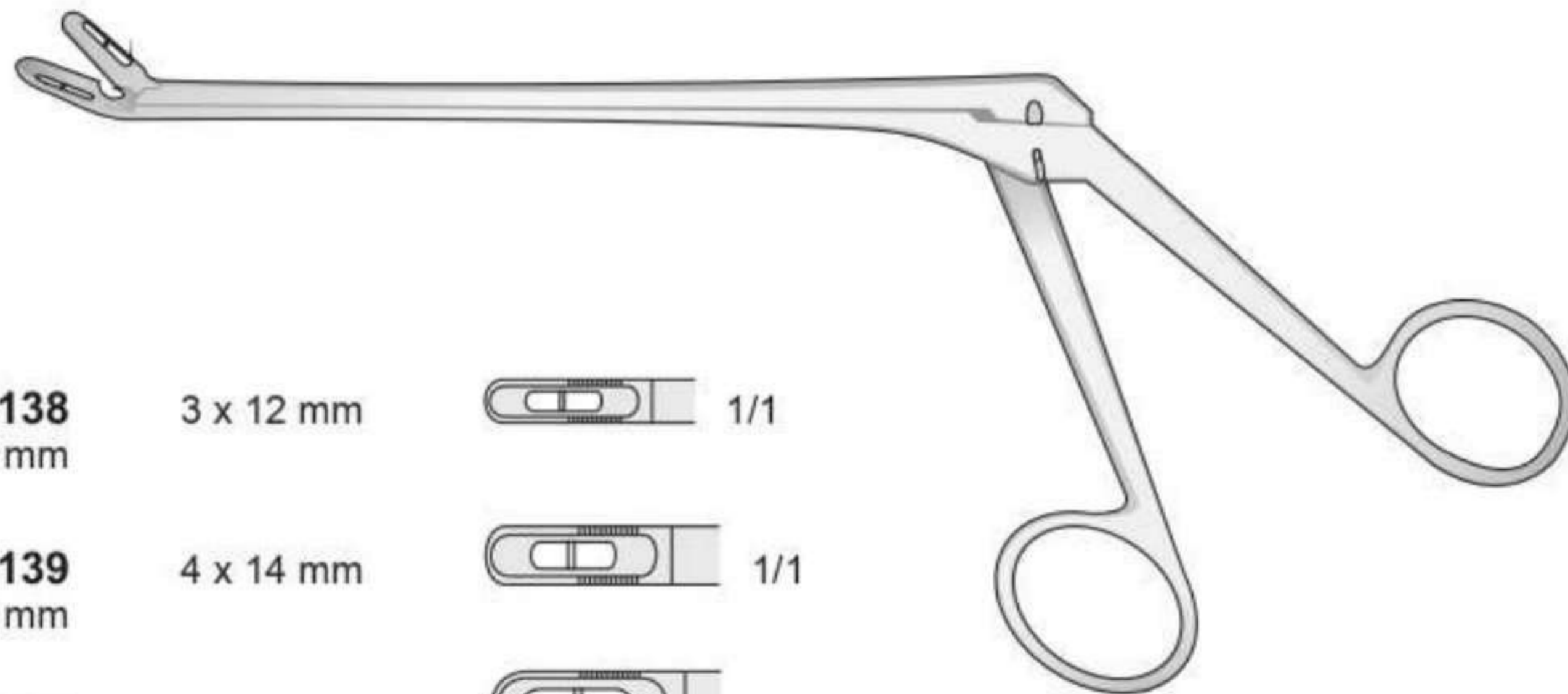

CASPAR

FF-133 140 mm	FF-135 160 mm	FF-138 185 mm	3 x 12 mm	 1/1
FF-134 140 mm	FF-136 160 mm	FF-139 185 mm	4 x 14 mm	 1/1
	FF-137 160 mm	FF-140 185 mm	5 x 14 mm	 1/1

CASPAR
FF-133/FF-140

Abwärts gebogen
Bottom curved
Curva verso il basso
Curvos
Courbe vers le bas

150°

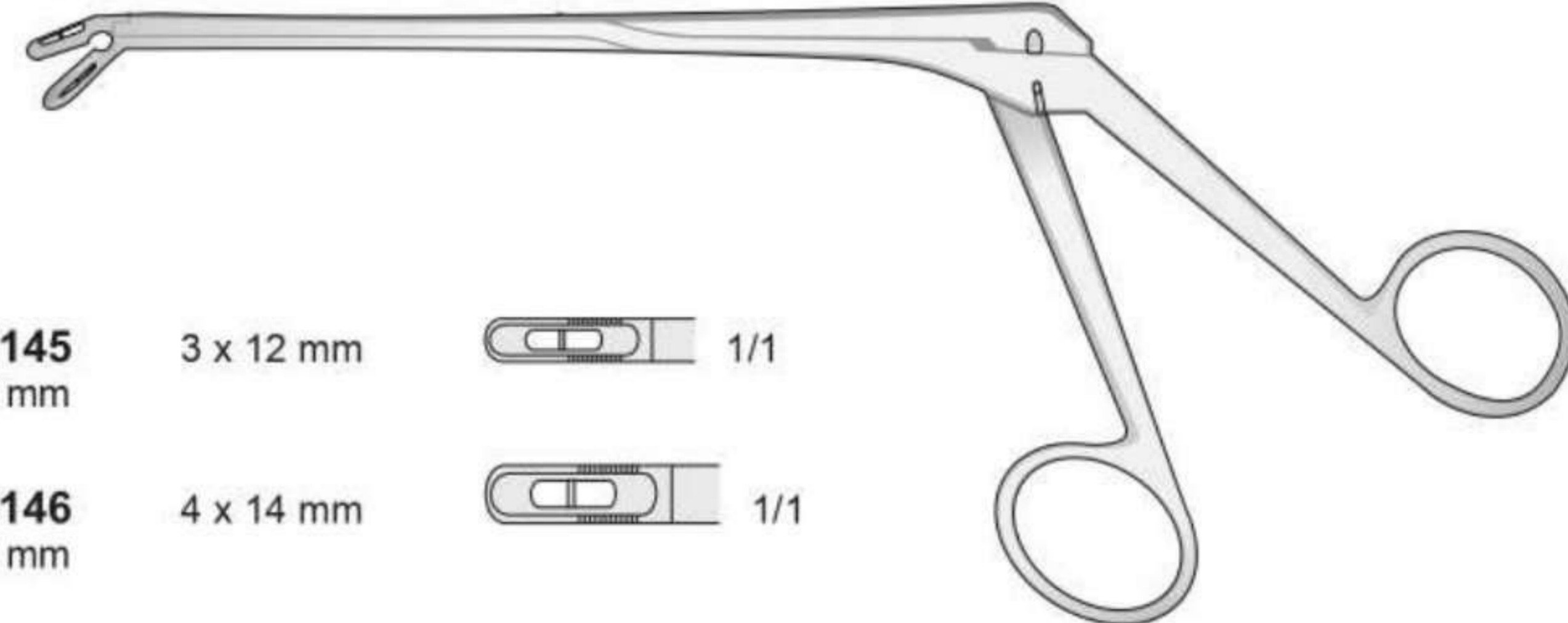

CASPAR

FF-141 140 mm	FF-143 160 mm	FF-145 185 mm	3 x 12 mm	 1/1
FF-142 140 mm	FF-144 160 mm	FF-146 185 mm	4 x 14 mm	 1/1

CASPAR
FF-141/FF-146

Hohlmeißelzangen
für Laminektomie

Laminectomy
Rongeurs

Pinze ossivore
per laminectomia

Pinzas gubias
para laminectomia

Pinces-gouges
pour laminectomie

Gerade
Straight
Diritta
Rectas
Droites

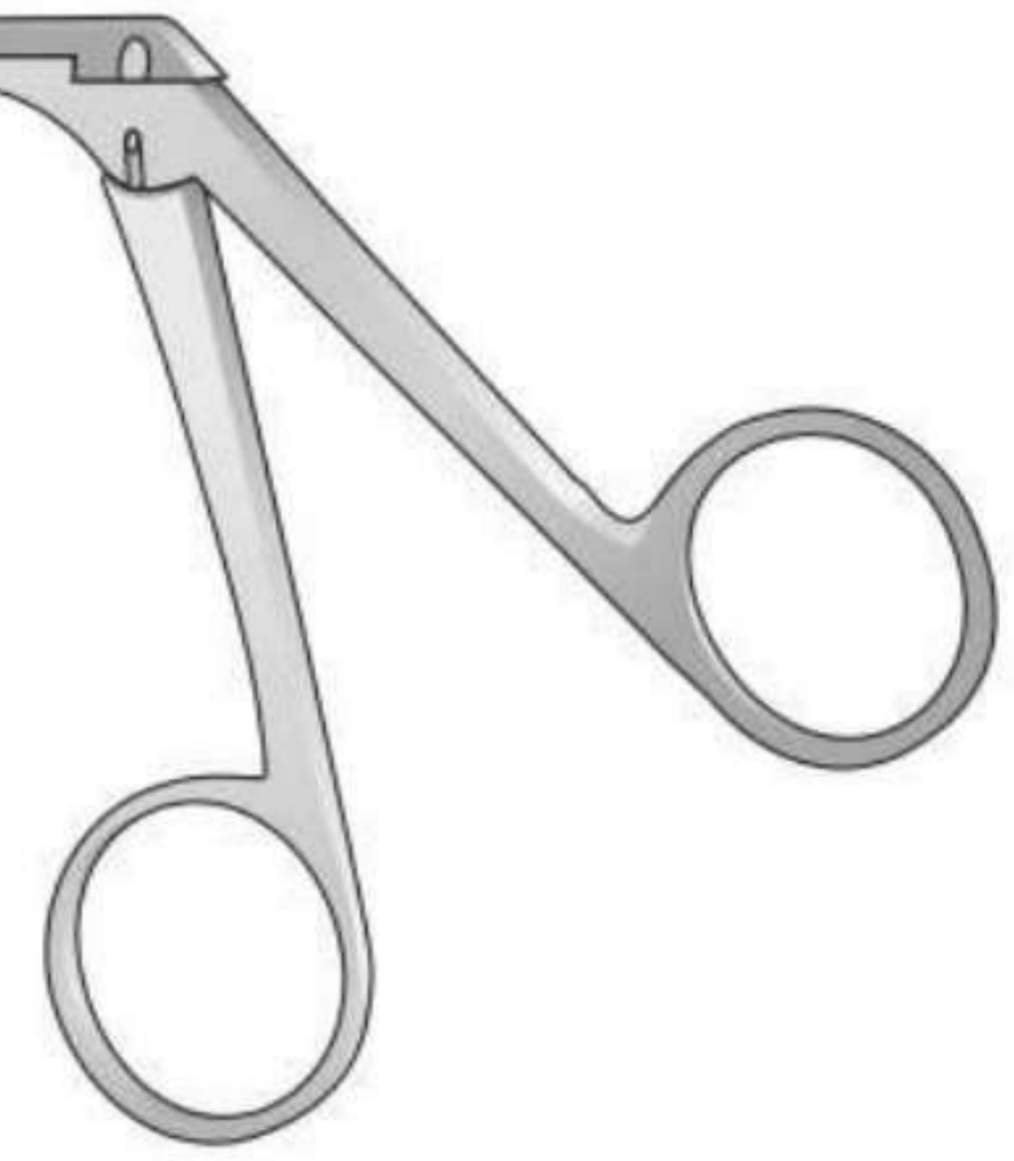
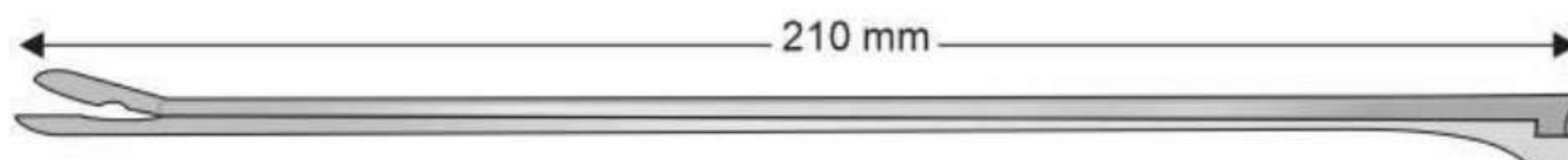

WAGNER
FF-90

Gerade
Straight
Diritta
Rectas
Droites

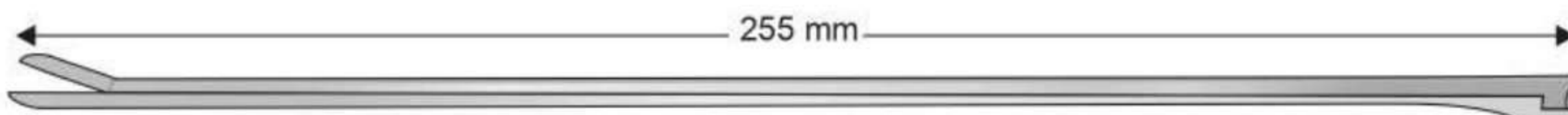

FF-91

Aufwärtsgebogen
Top curved
Curva verso l'alto
Curvos
Courbe vers le haut

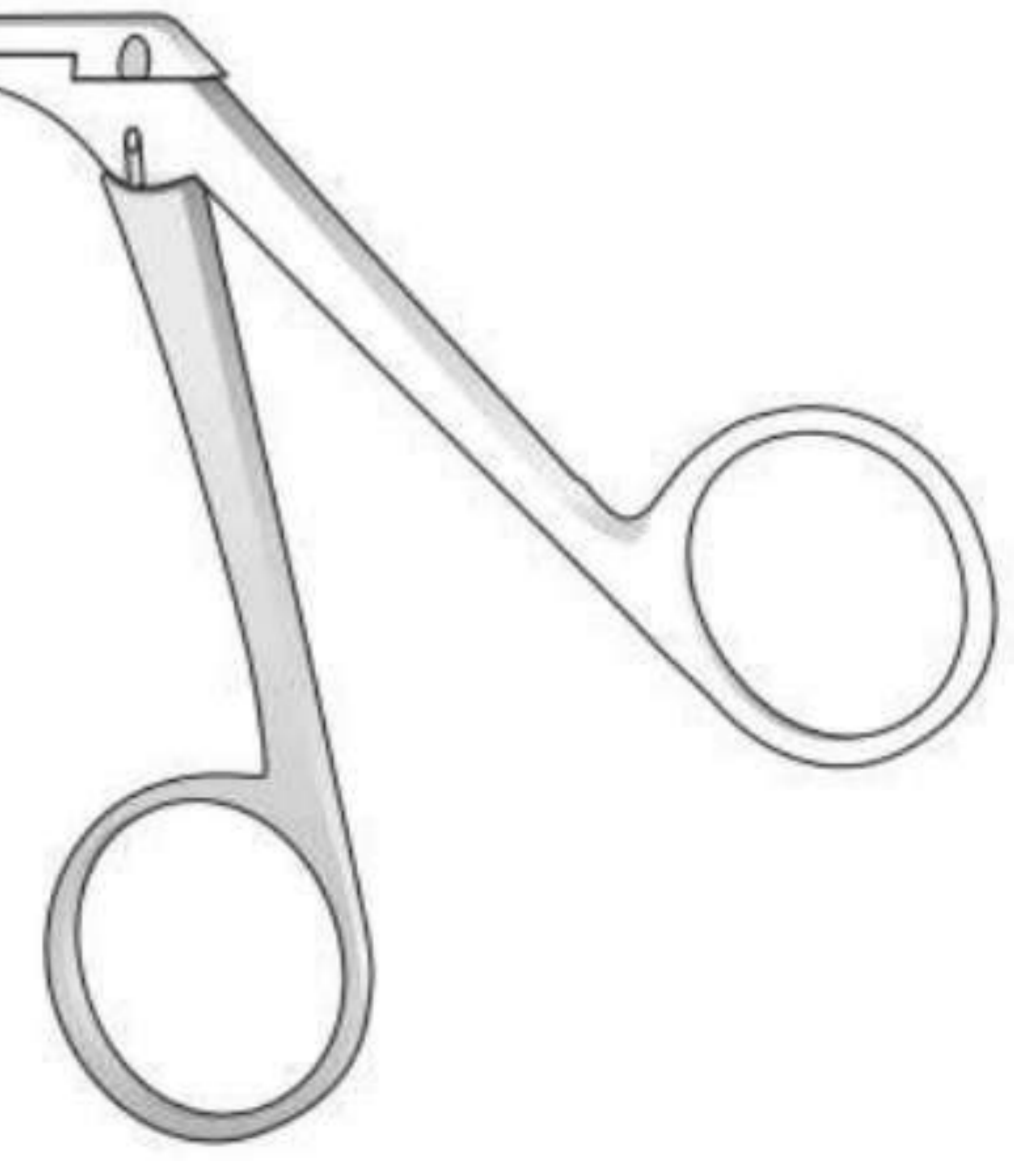
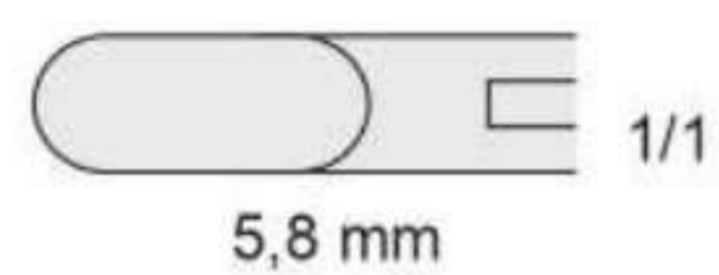
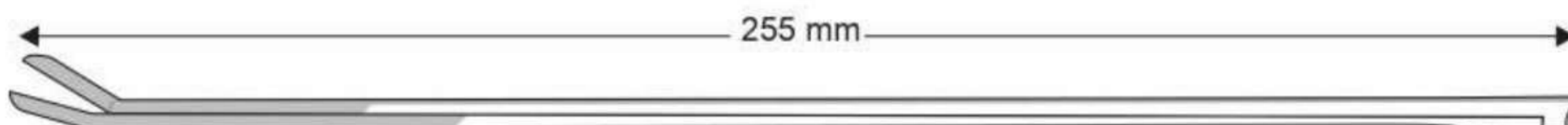

SYPERT
FF-92

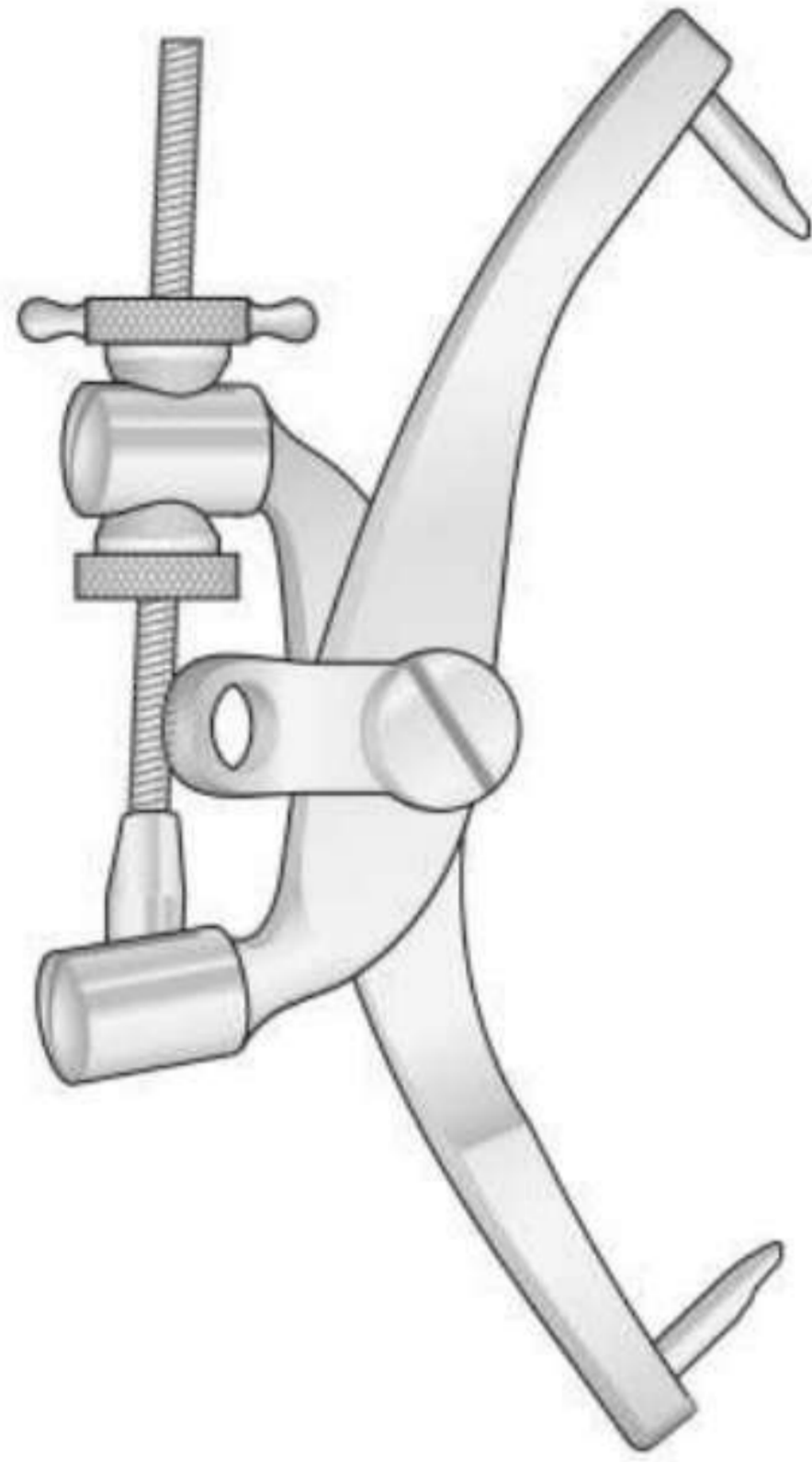

CRUTCHFIELD
FF-394

Drill points only
Vorbohrer dazu

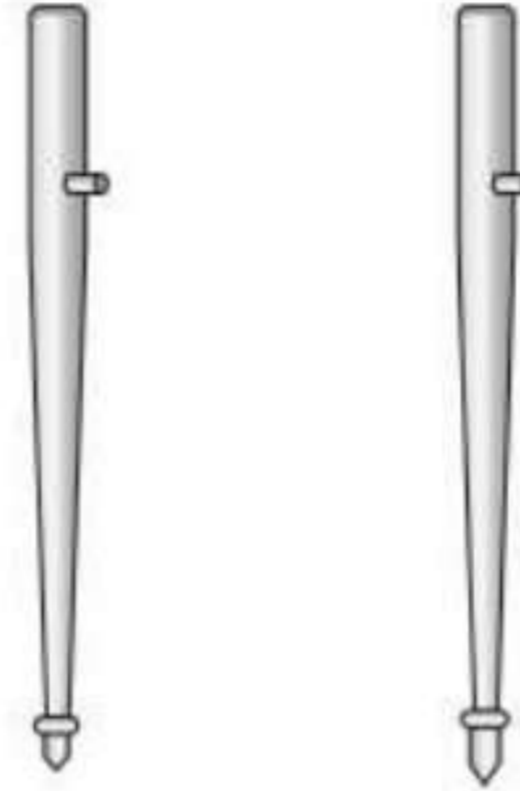

FF-395

FF-396

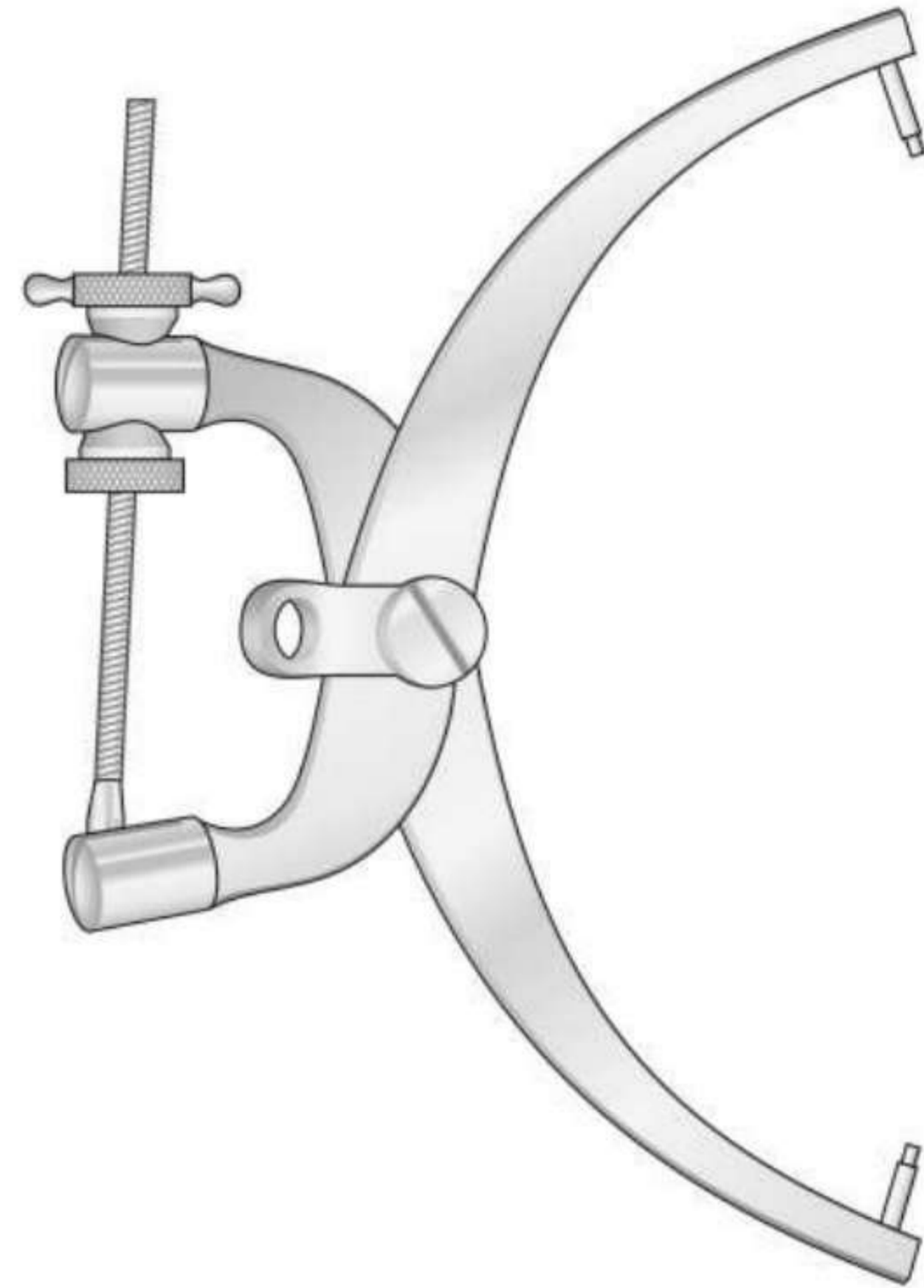

CRUTCHFIELD
FF-397



FF-398

Doppelschlüssel zu FF-398



FF-399

Messer

Knives

Coltelli

Cuchillos

Couteaux

Amputation
Amputazione



1/1

NK-31/NK-57



1/1

NK-50
150 mm



1/1

NK-51
155 mm



1/1

NK-31
158 mm



1/1

NK-52
160 mm



1/1

NK-53
170 mm



1/1

NK-35
175 mm



1/1

NK-54
150 mm



1/1

NK-55
155 mm



1/1

NK-33
158 mm



1/1

NK-56
160 mm



1/1

NK-57
170 mm



1/1

NK-37
175 mm

Organmesser

Post-mortem Knives

Coltello per autopsia

Cuchillos para autopsia

Couteaux à autopsie

mm: Schnittlänge
 Length of blades
 Lunghezza della lama
 Largo de hojas
 Longueur de la lame

Metallheft
 Metal handle
 Manico in metallo
 Mango metálico
 Manche métal

Holzheft
 Wooden handle
 Manico in legno
 Mango de madera
 Manche bois

Metallheft
 Metal handle
 Manico in metallo
 Mango metálico
 Manche métal

Metallheft
 Metal handle
 Manico in metallo
 Mango metálico
 Manche métal

Resektionsmesser
 Resection knives
 Coltello per resezione
 Cuchillos para resección
 Couteaux à résection

Organmesser
 Post mortem knives
 Coltello per autopsia
 Cuchillos para órganos
 Couteaux à autopsie

Organmesser
 Post mortem knives
 Coltello per autopsia
 Cuchillos para órganos
 Couteaux à autopsie

Hirnmesser
 Brain knives
 Coltello per cervello
 Cuchillos para cerebro
 Couteaux à cerveau



AN-10
55 mm

1/1



AN-11
55 mm

1/1



AN-12
110 mm



AN-13
170 mm



AN-14
195 mm



1/1



VIRCHOW AN-15
160 mm



VIRCHOW AN-16
200 mm



VIRCHOW AN-17
240 mm

LANGENBECK AN-10/AN-11
55 mm

Knochenfeilen

Bone Files

Lime per osso

Limas para huesos

Limes à os

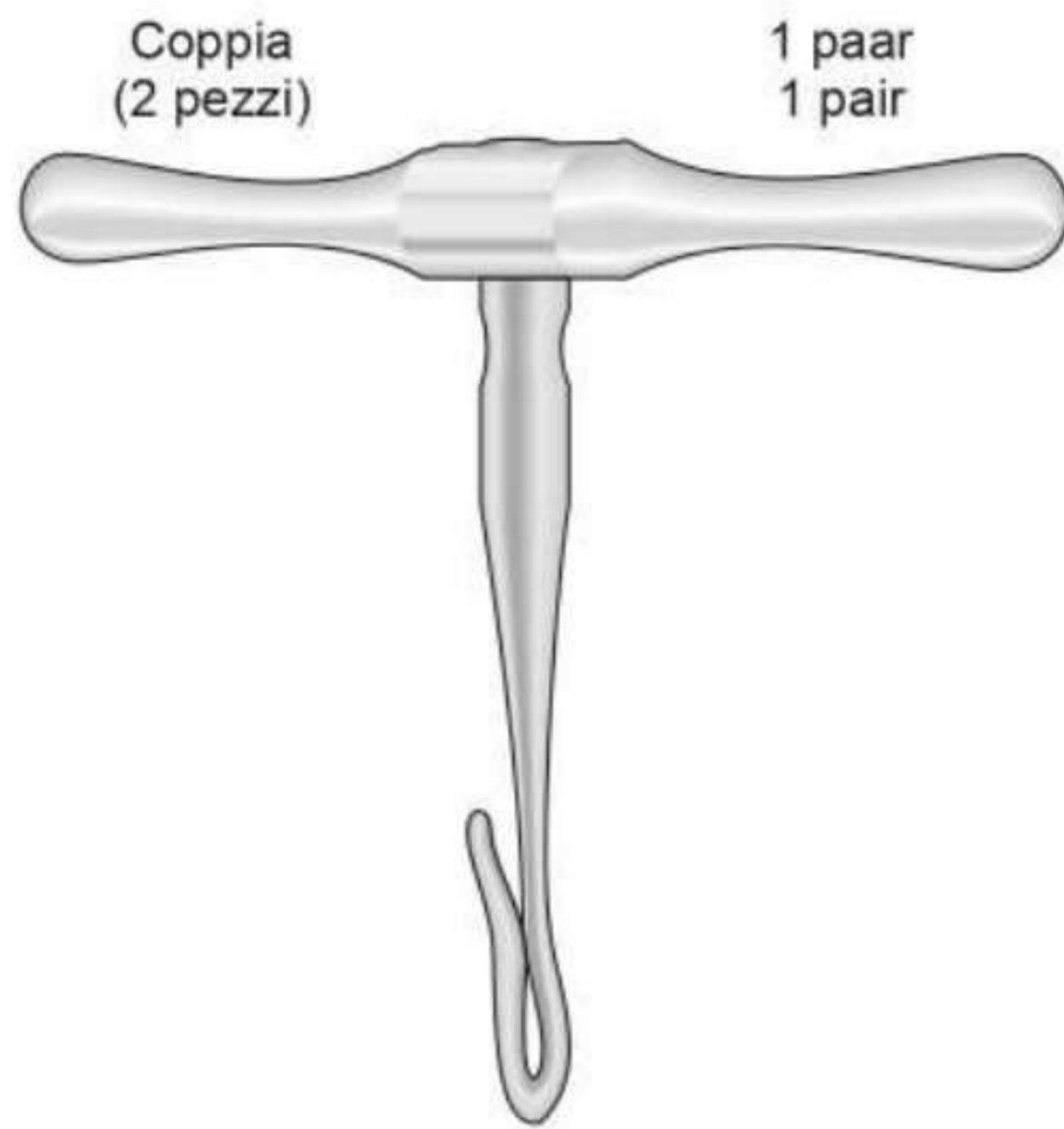

Coppia
(2 pezzi)

1 paar
1 pair

GIGLI
FK-11

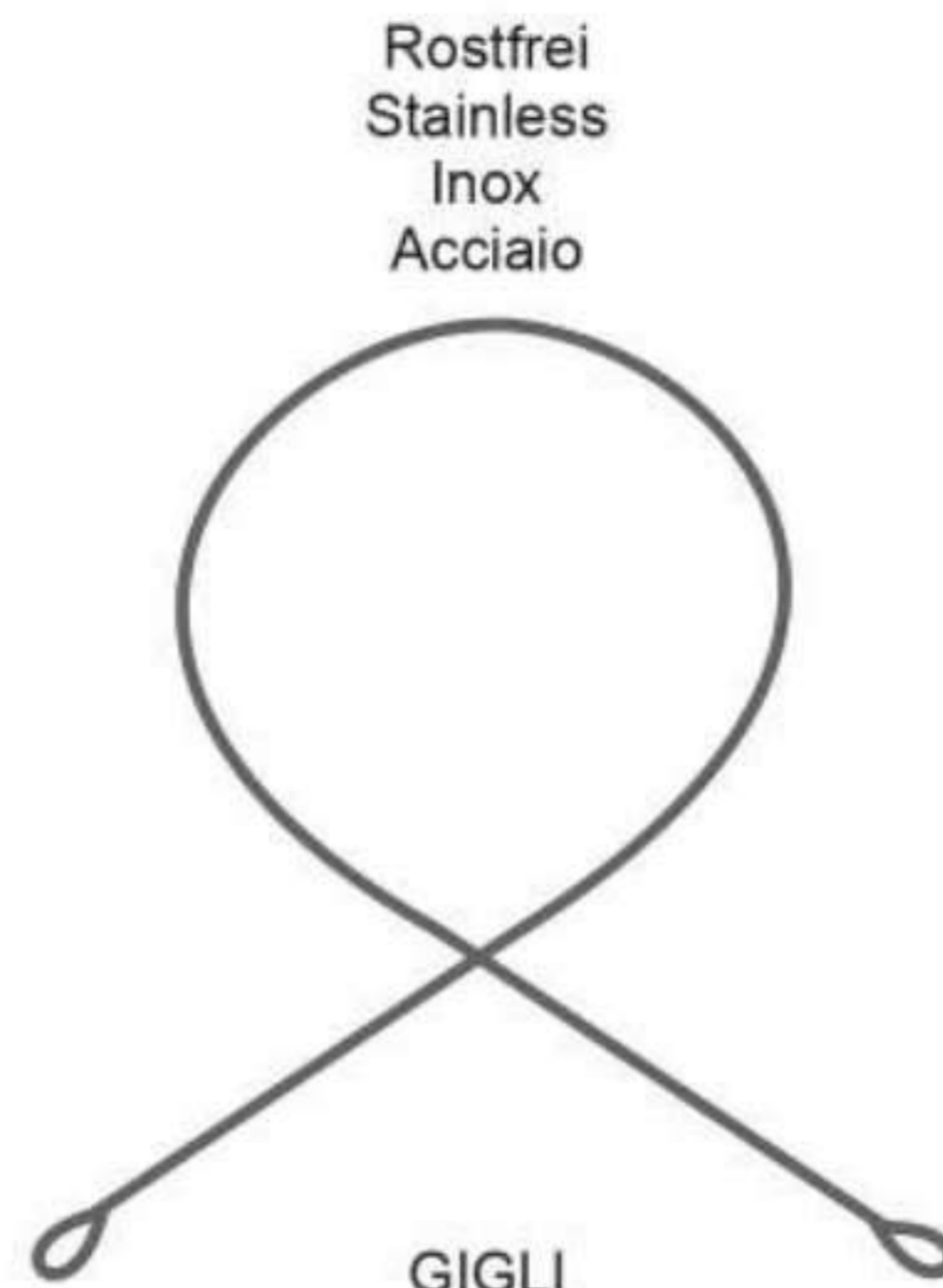

Rostfrei
Stainless
Inox
Acciaio

GIGLI
FK-13
300 mm
FK-14
500 mm

LS-300

Komplett mit 3 Sägen
Complete with 3 saws
Completa con 3 seghe
Completo con 3 sierras
Complet avec 3 scies

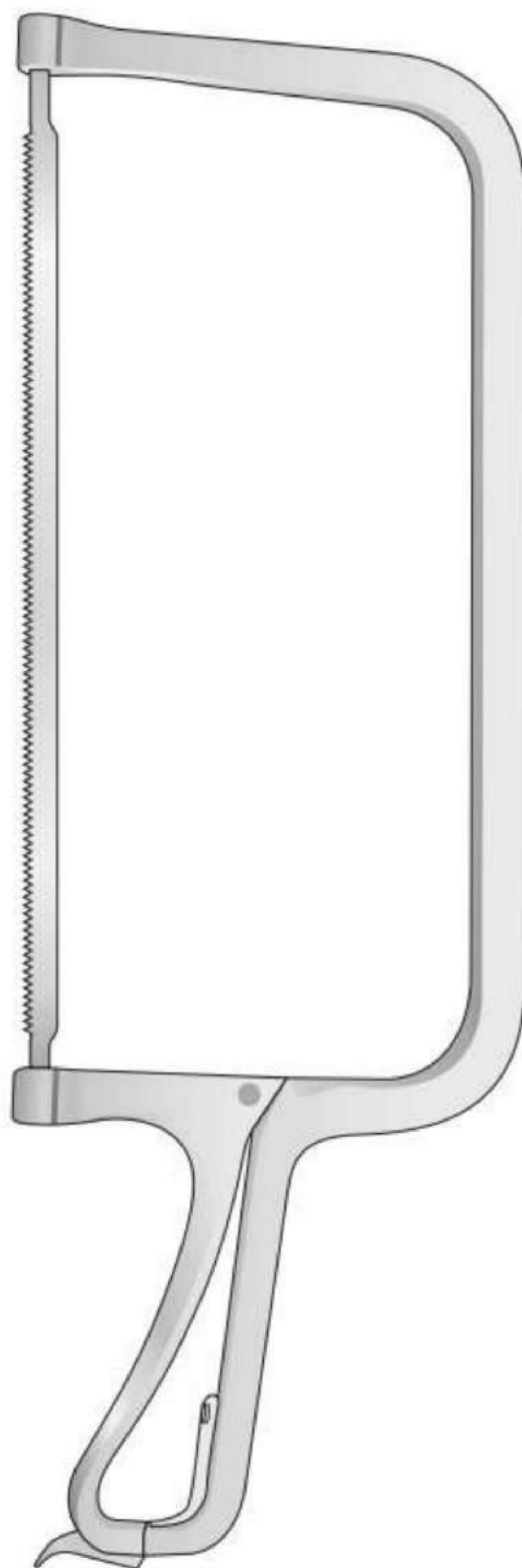

COLLIN
LS-300
390 mm

Fig.1

Fig.2

Fig.3



LS-301
280 mm



LS-302
280 mm



LS-303
280 mm



LINDEMANN
FK-243
200 mm

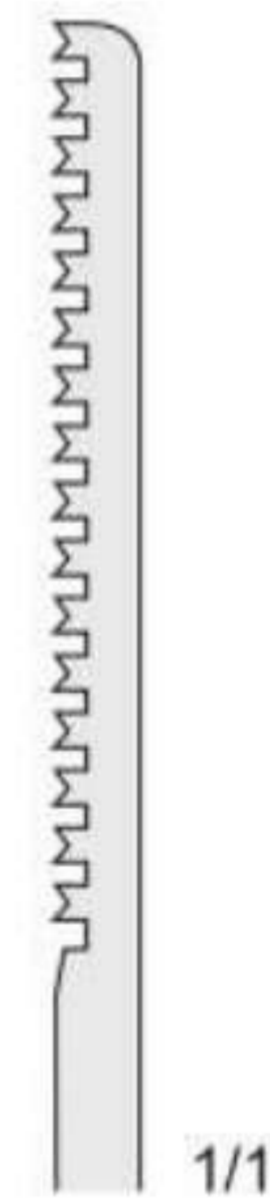

1/1



LANGENBECK
FK-244
235 mm

**Skalpellinge
und Skalpellgriffe**



LB-361
Conf. 10 pz.



LB-362
Conf. 10 pz.



LB-363
Conf. 1 pz.



LB-364
Conf. 10 pz.



LB-365
Conf. 10 pz.

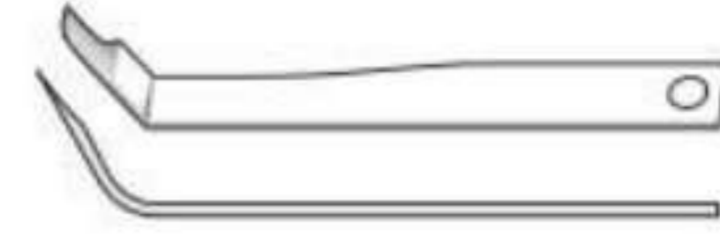

LB-366
Conf. 1 pz.



LB-367
Conf. 10 pz.



LB-368
Conf. 10 pz.



LB-369
Conf. 1 pz.



NK-1
100 mm



NK-2
150 mm



BB-46
135 mm



**LANDOLT
BB-38**
250 mm



**LANDOLT
BB-40**
210 mm



Tuchklemmen

Towel clamps

Fissateli

Pinzas de campo

Pince fixe-compresses

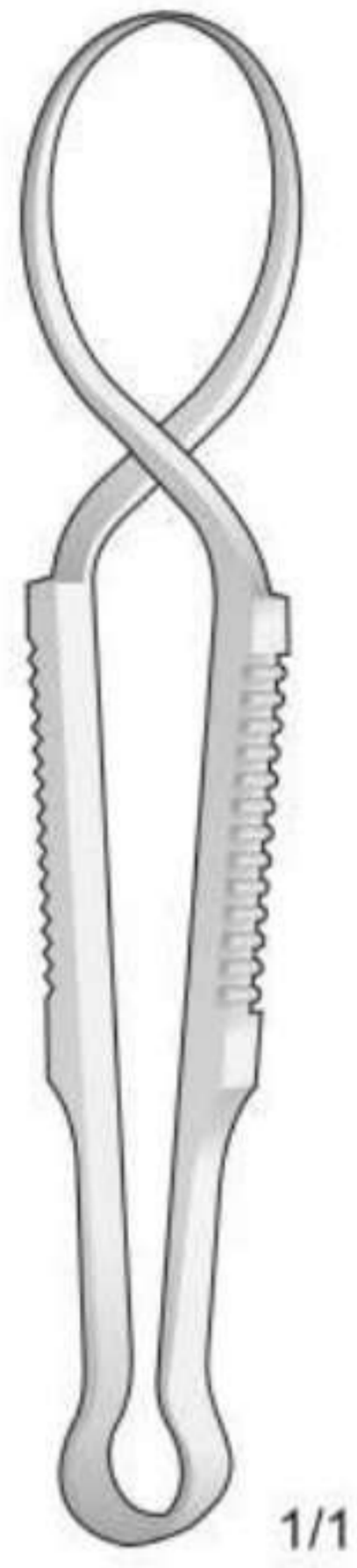

SCHAEDDEL
BF-38
85 mm

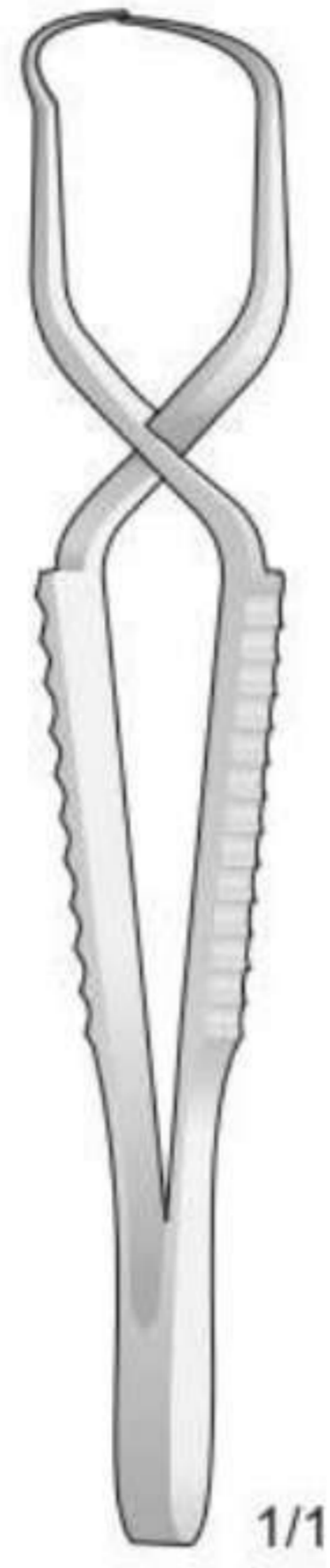

FAURE
BF-40
85 mm

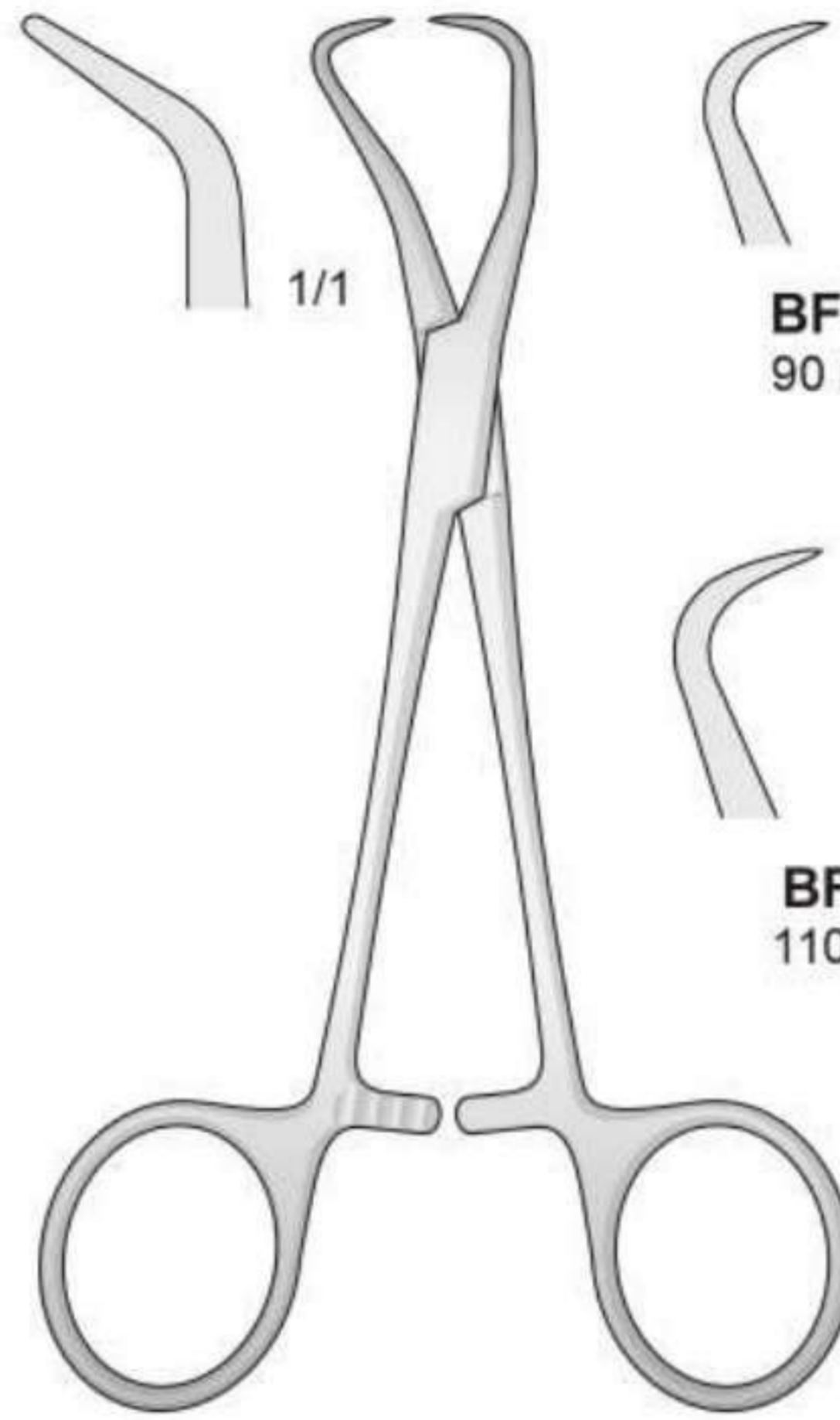

BACKHAUS
BF-41/BF-46

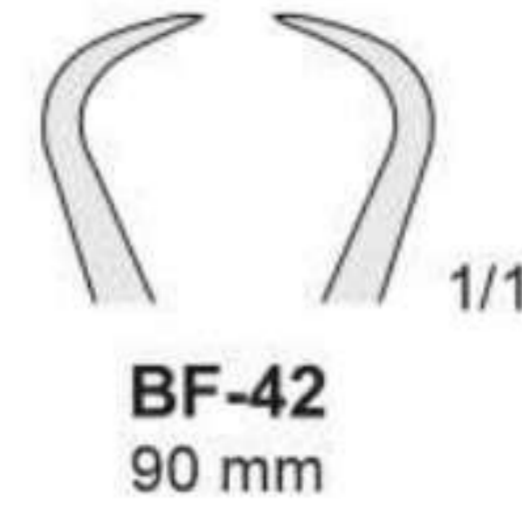

BF-42
90 mm

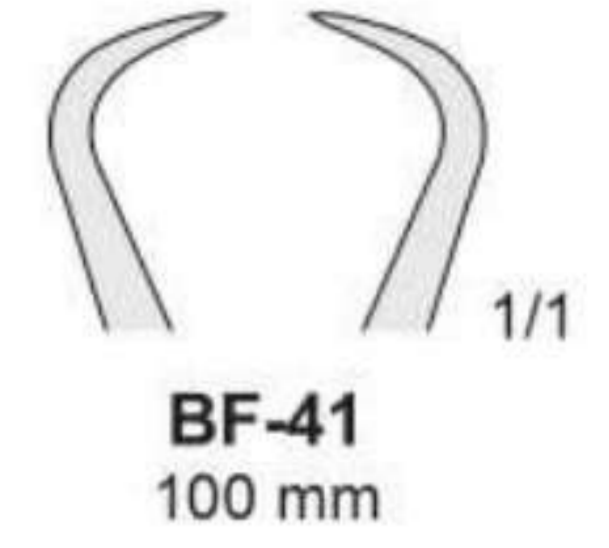

BF-41
100 mm

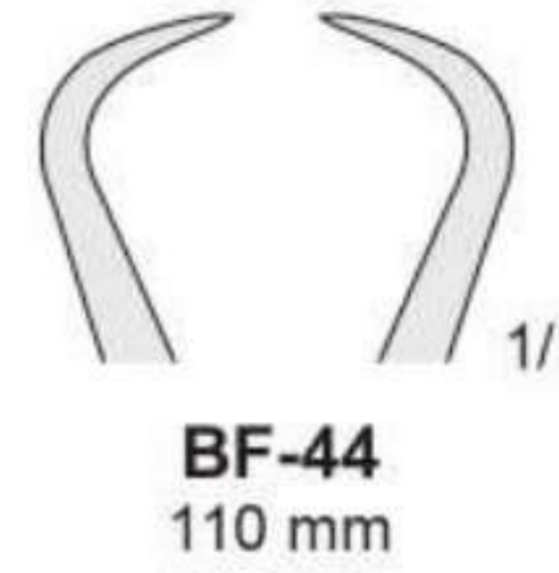

BF-44
110 mm

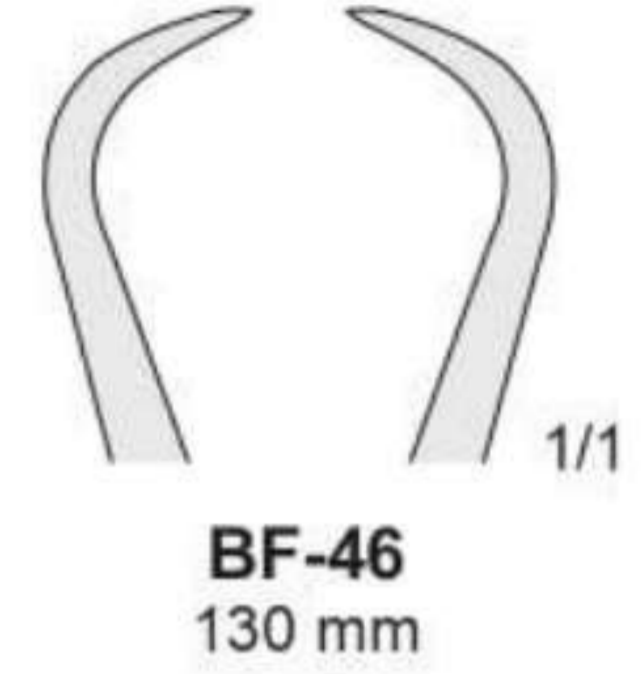

BF-46
130 mm

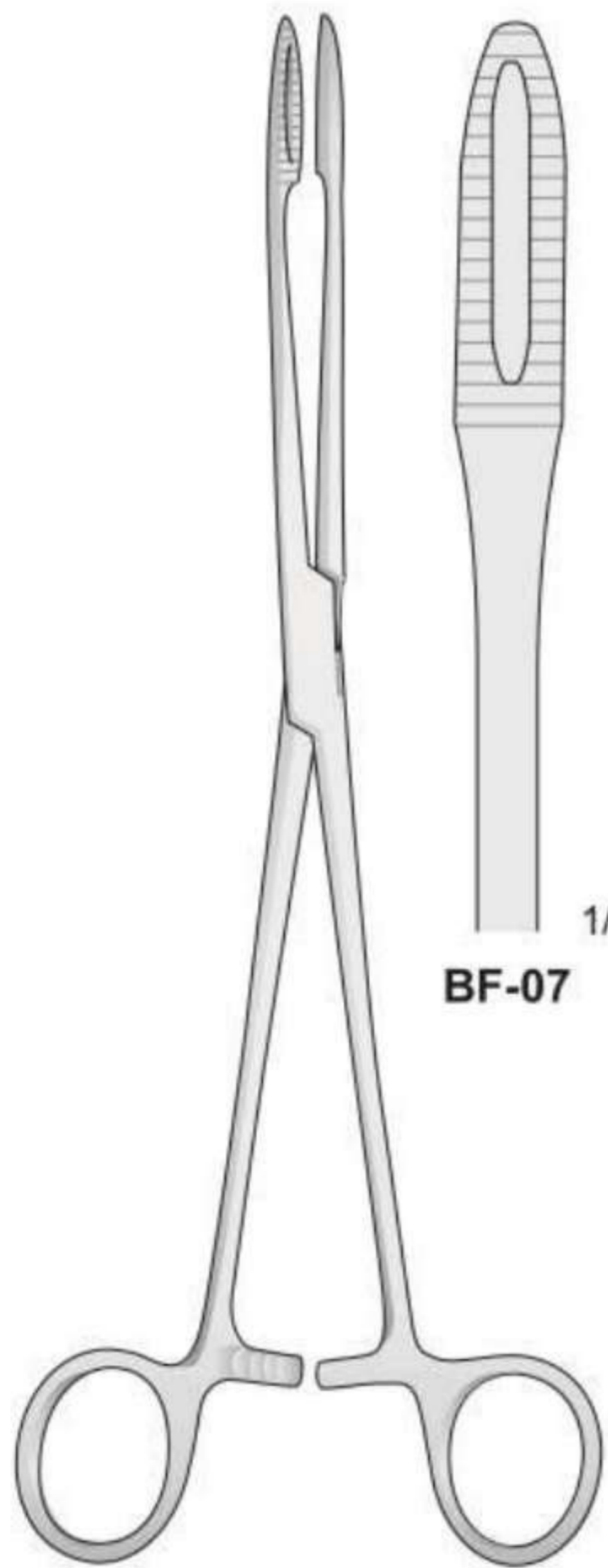

MAIER
BF-07/BF-08
265 mm

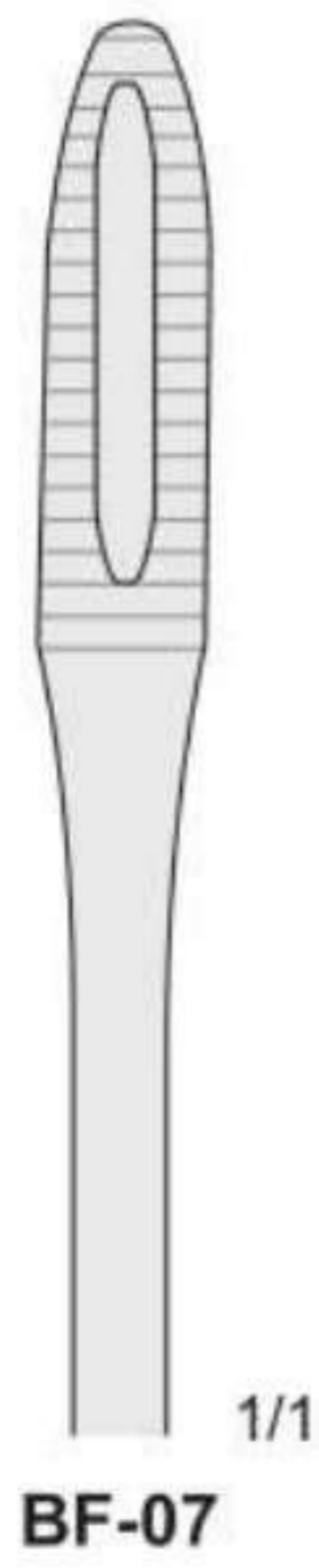

BF-07



BF-08

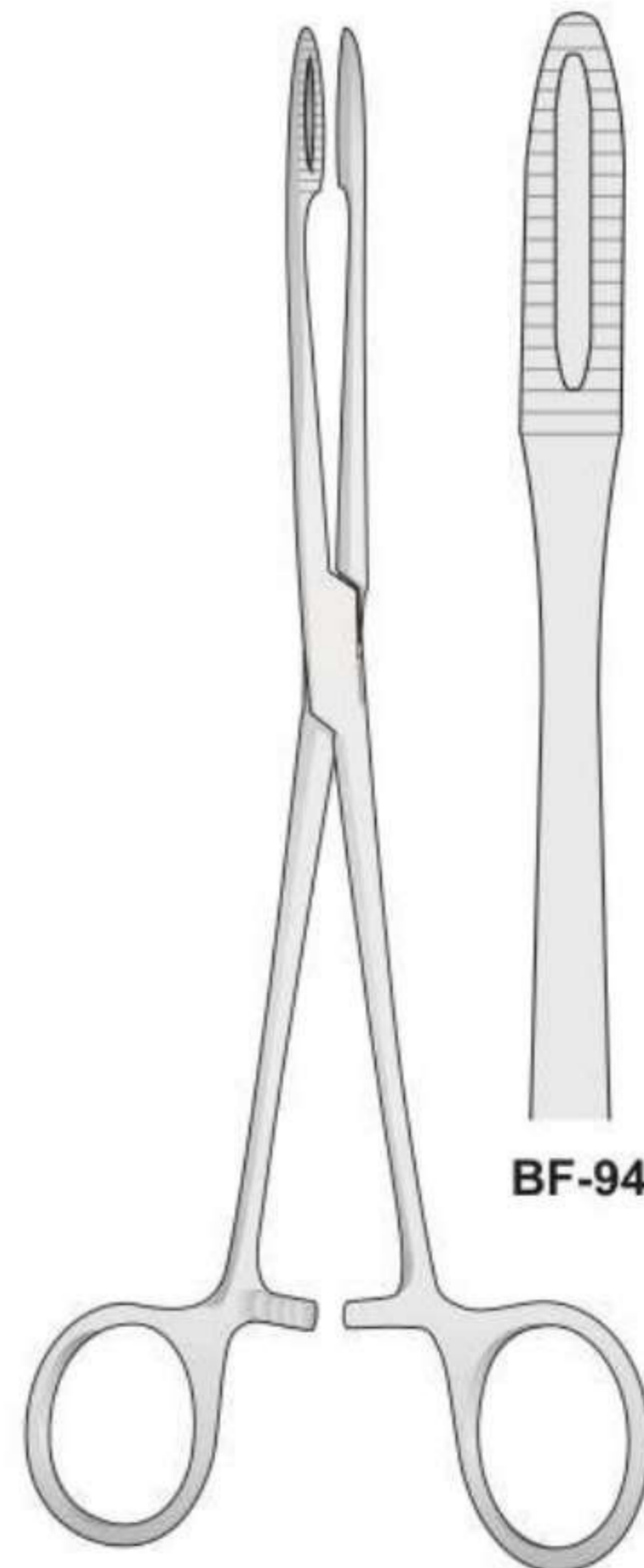

GROSS
BF-94/BF-95
200 mm

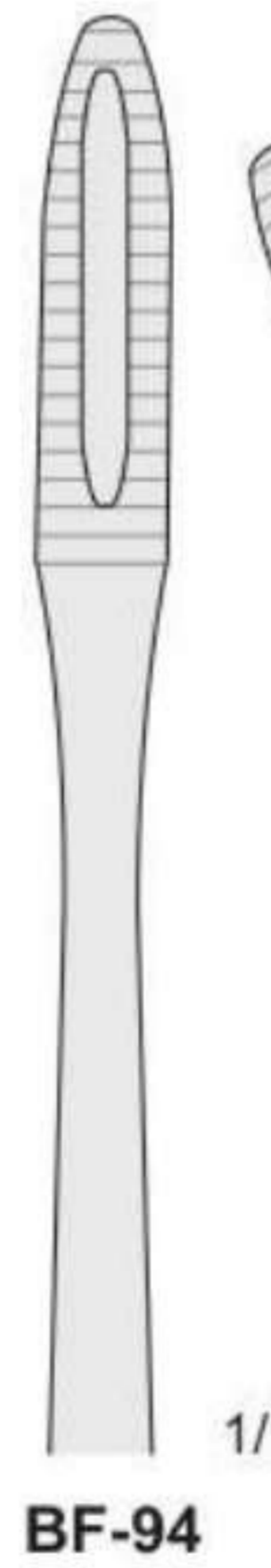

BF-94

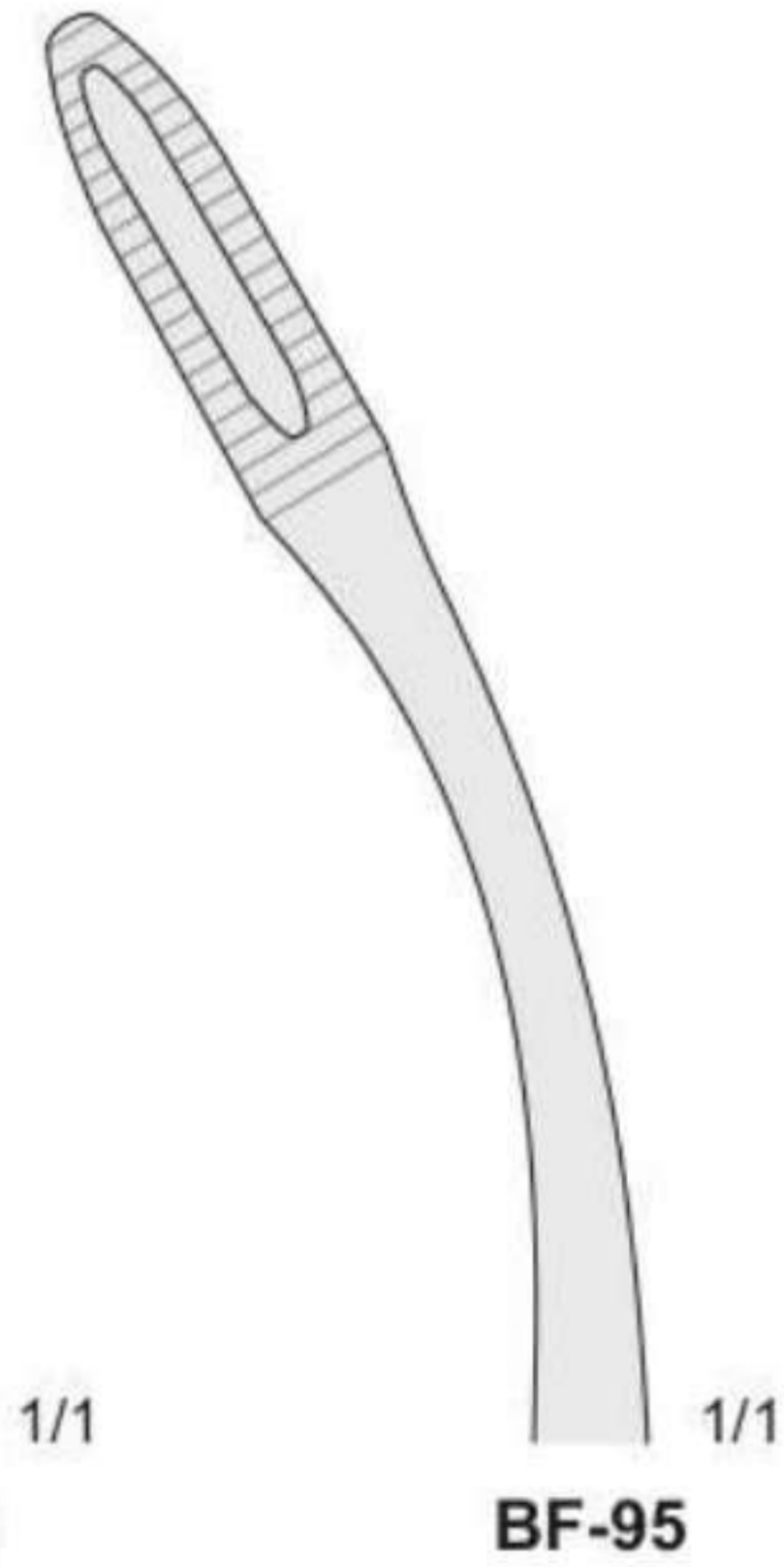

BF-95

Irisscheren

Iris scissors

Forbici per iridectomia

Tijeras para iridectomía

Ciseaux à iridectomie

"Ribbon type"

Mit großen Ringen
With large rings
Forbici ad anelli grandi
Con anillos especialmente grandes
avec larges anneaux

Irisscheren - Iris scissors
Forbici per iridectomia - Tijeras para iridectomía
Ciseaux à iridectomie

Blepharoplasty
Blefaroplastica

Spitz - Sharp
Acuta - Aguda
Pointu

Spitz - Sharp
Acuta - Aguda
Pointu

Stumpf - Blunt
Smussa - Romas
Mousse

Spitz - Sharp
Acuta - Aguda
Pointu

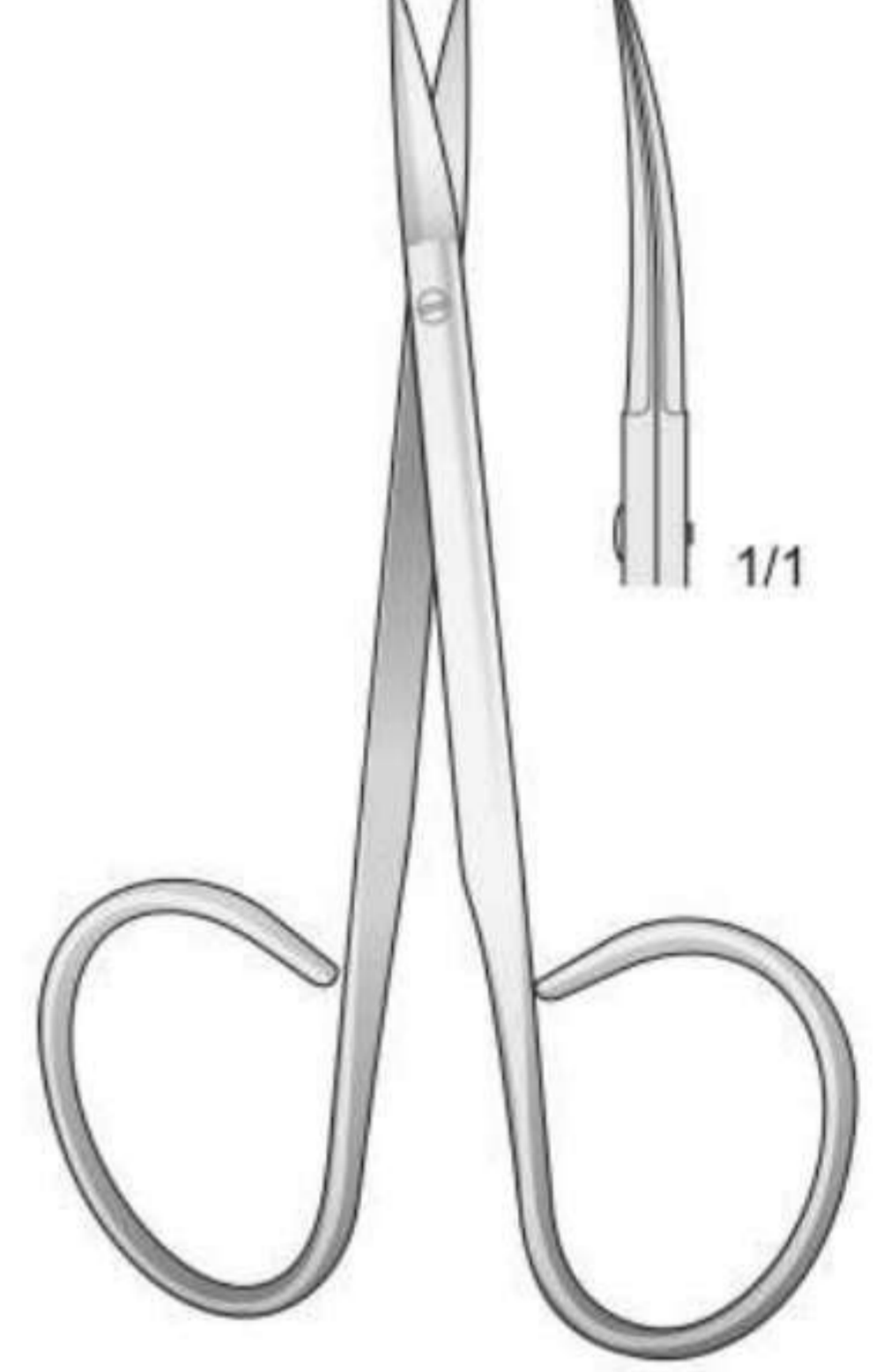
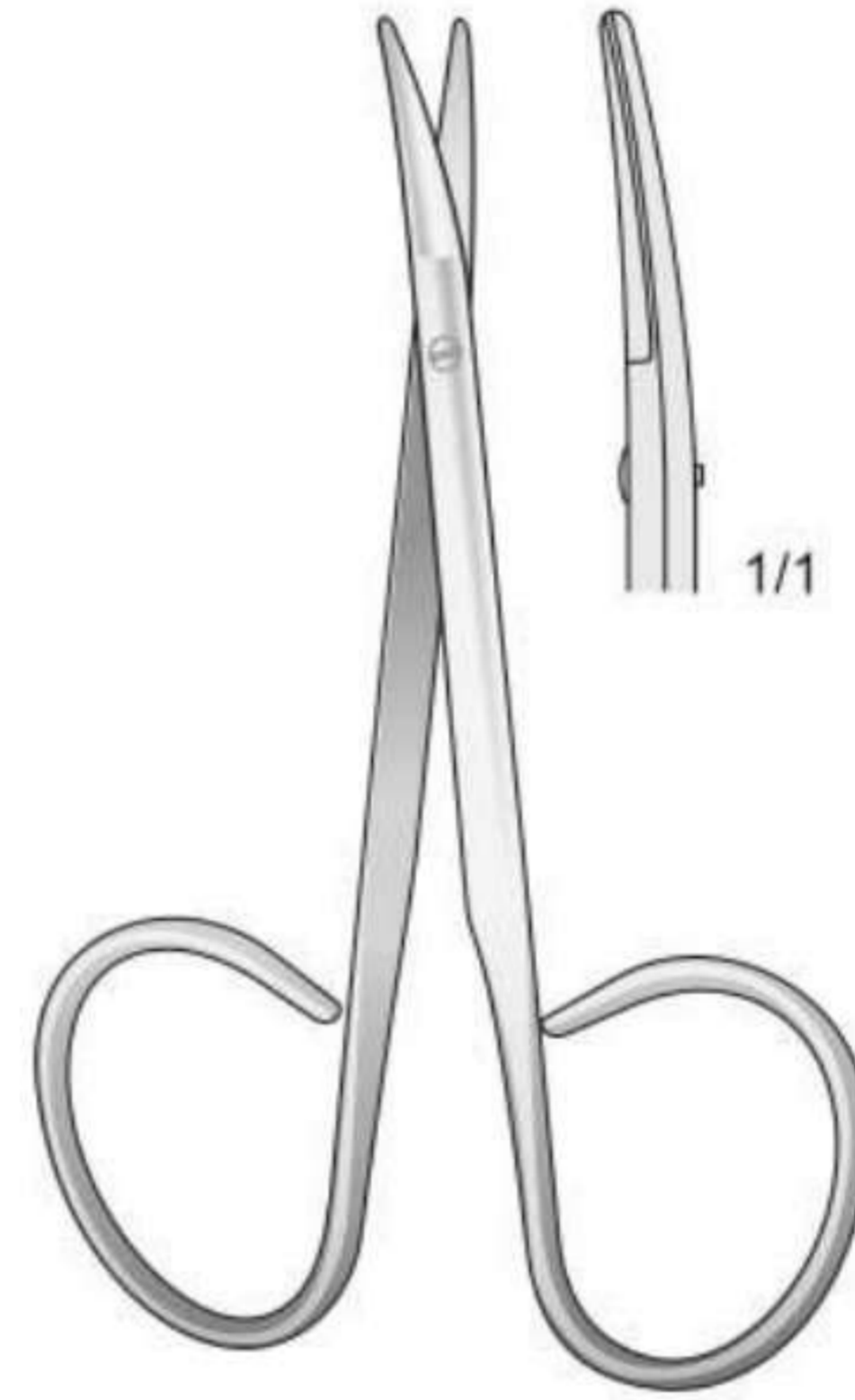
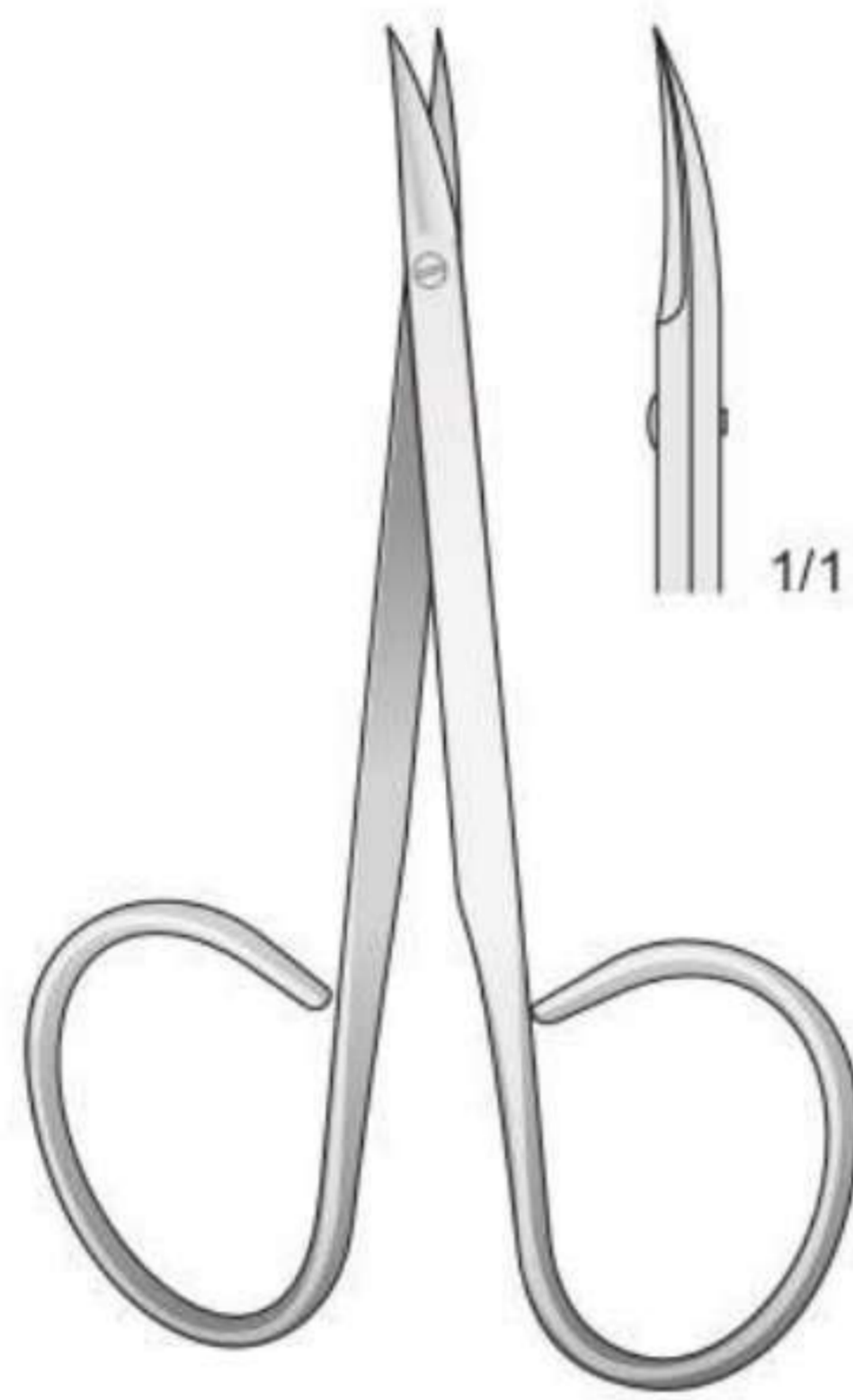
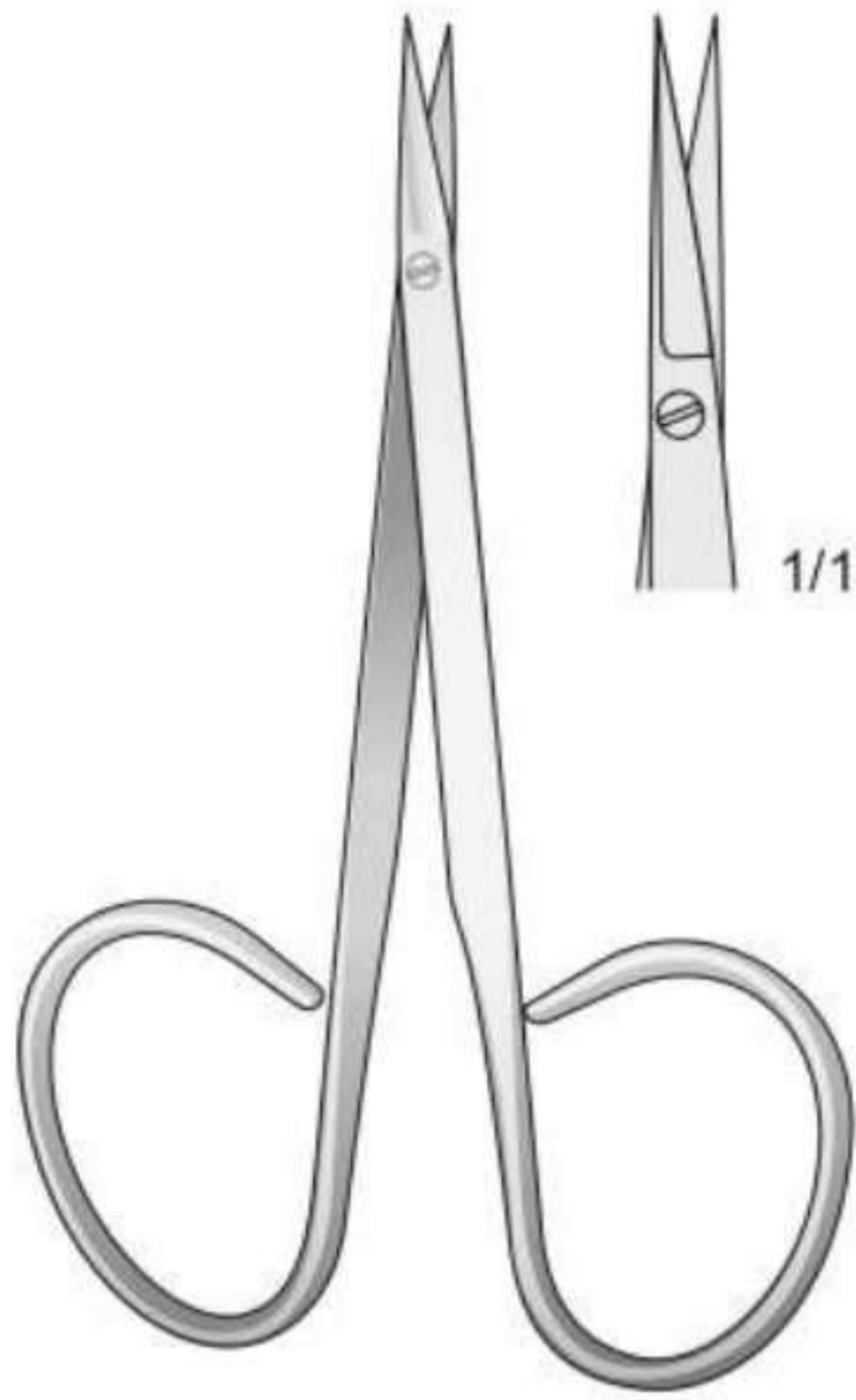

FG-200
95 mm

FG-201
95 mm

FG-202
95 mm

FG-203
105 mm

Strabimusscheren - Strabismus Scissors
Forbici da strabismo - Tijeras para estrabismo
Ciseaux à strabisme

Irisscheren - Iris scissors
Forbici per iridectomia - Tijeras para iridectomía
Ciseaux à iridectomie

Stumpf - Blunt
Smussa - Romas
Mousse

Stumpf - Blunt
Smussa - Romas
Mousse

Spitz - Sharp
Acuta - Aguda
Pointu

Spitz - Sharp
Acuta - Aguda
Pointu

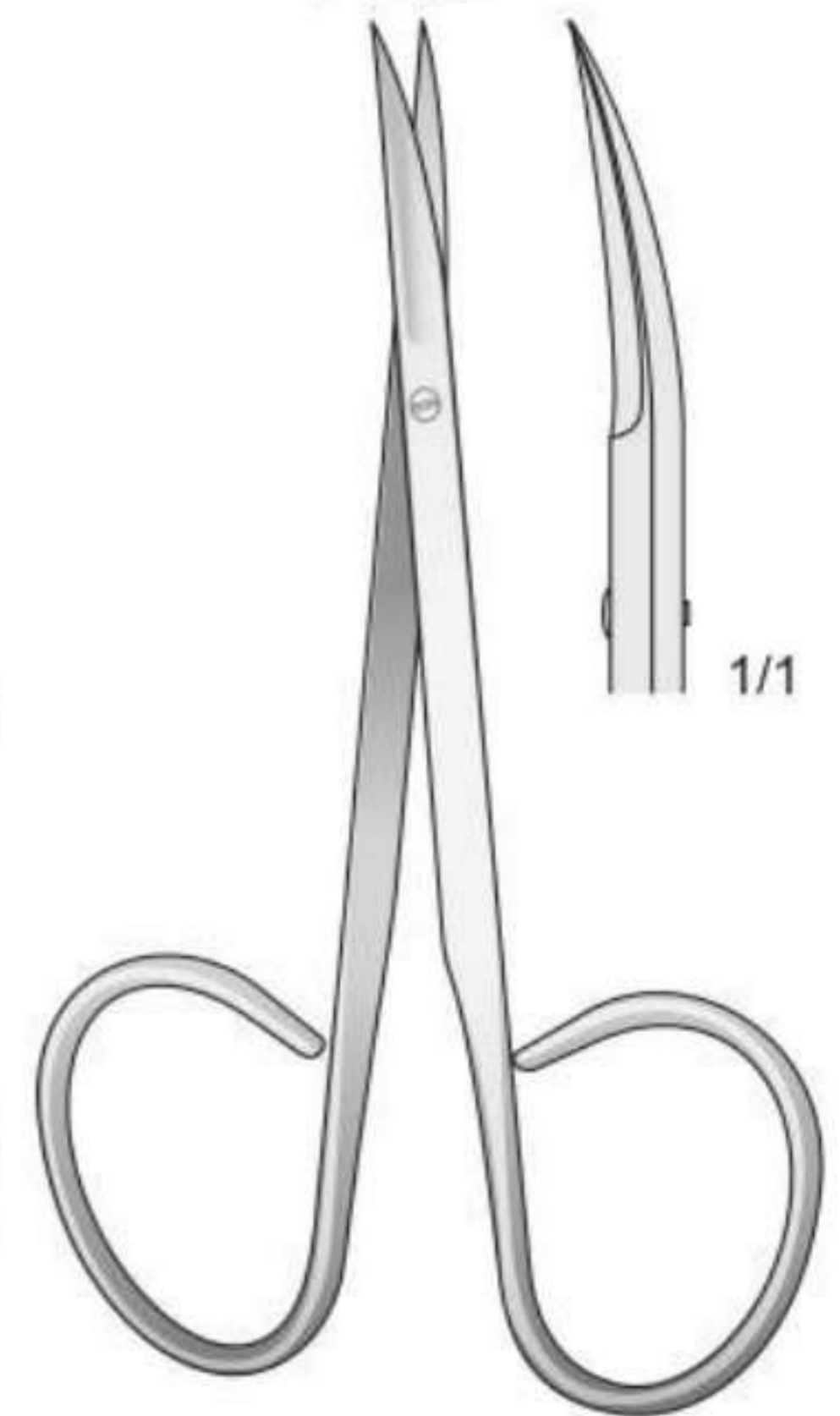
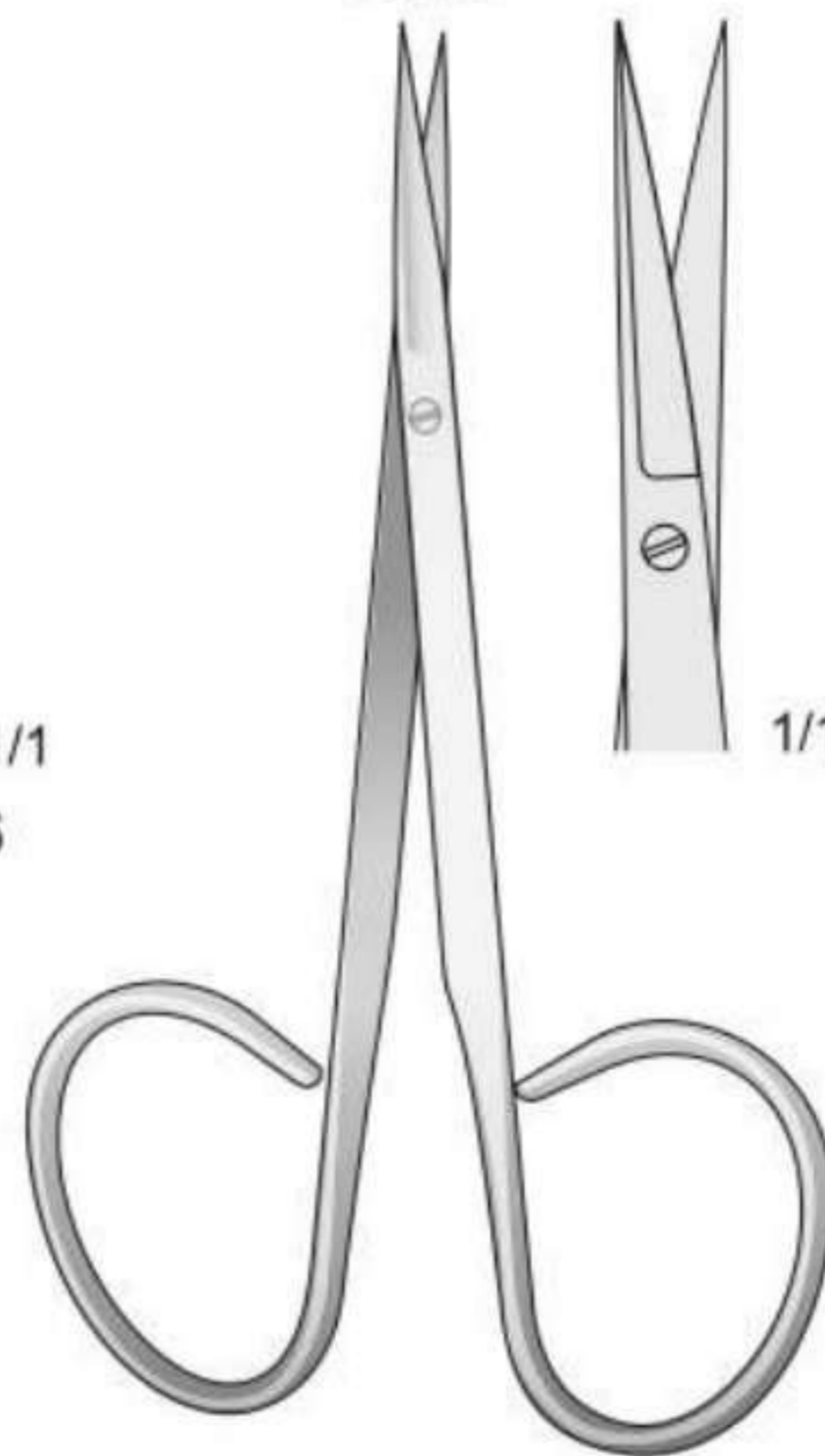
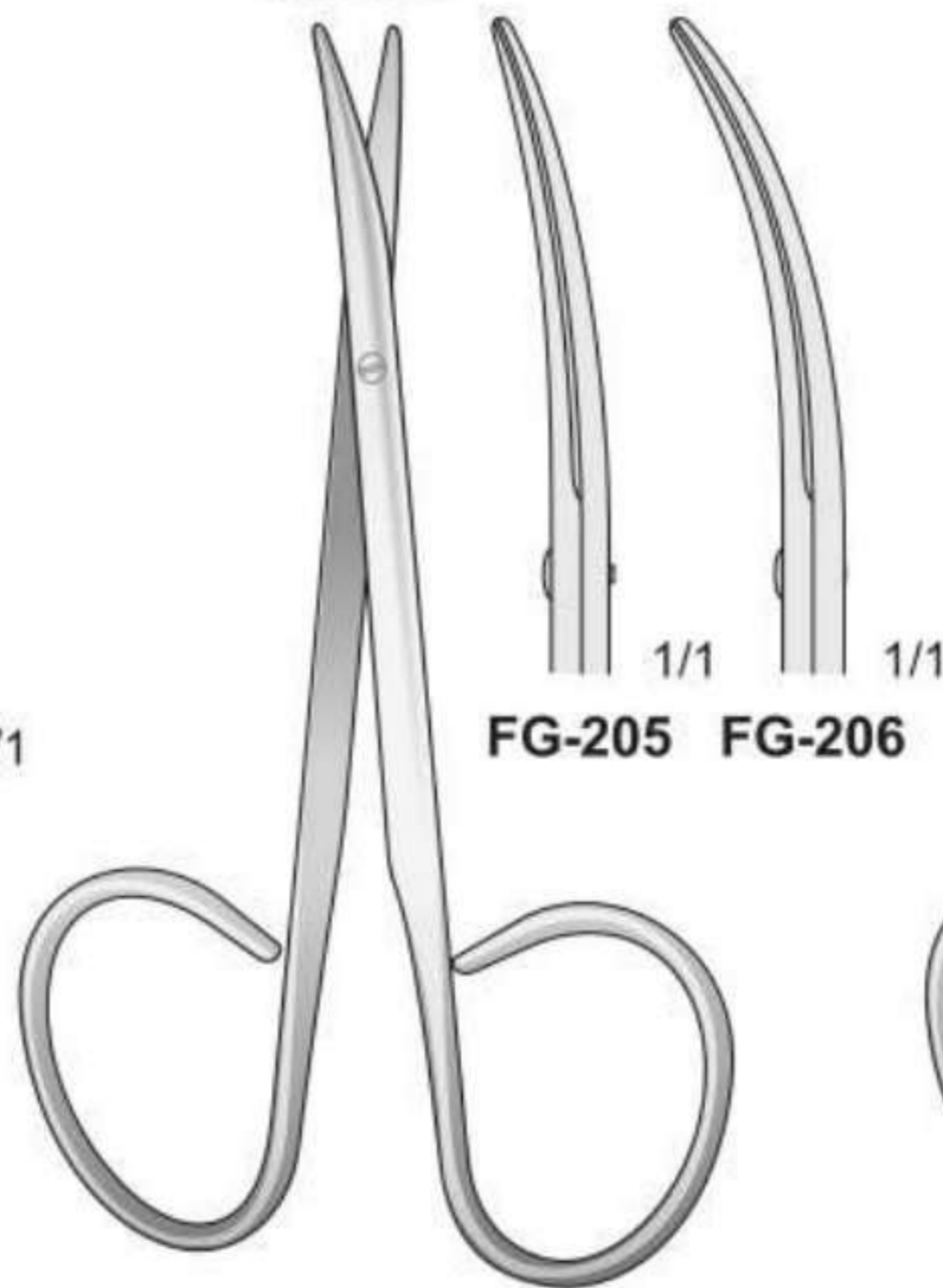
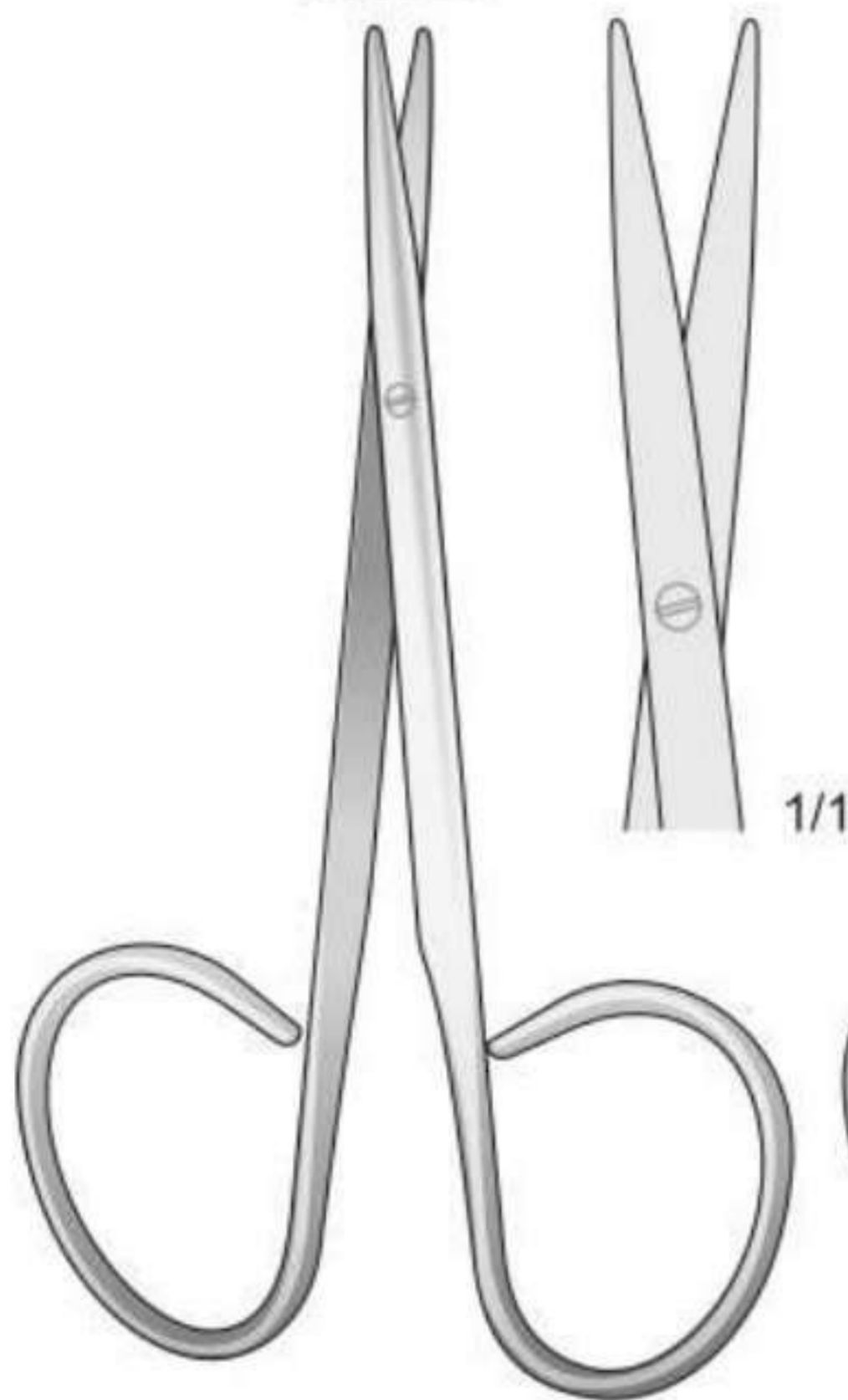

FG-204
100 mm

FG-205/FG-206
100 mm

FG-207
105 mm

FG-208
105 mm

Feine Scheren

Delicate scissors

Forbici delicate

Tijeras finas

Ciseaux fines

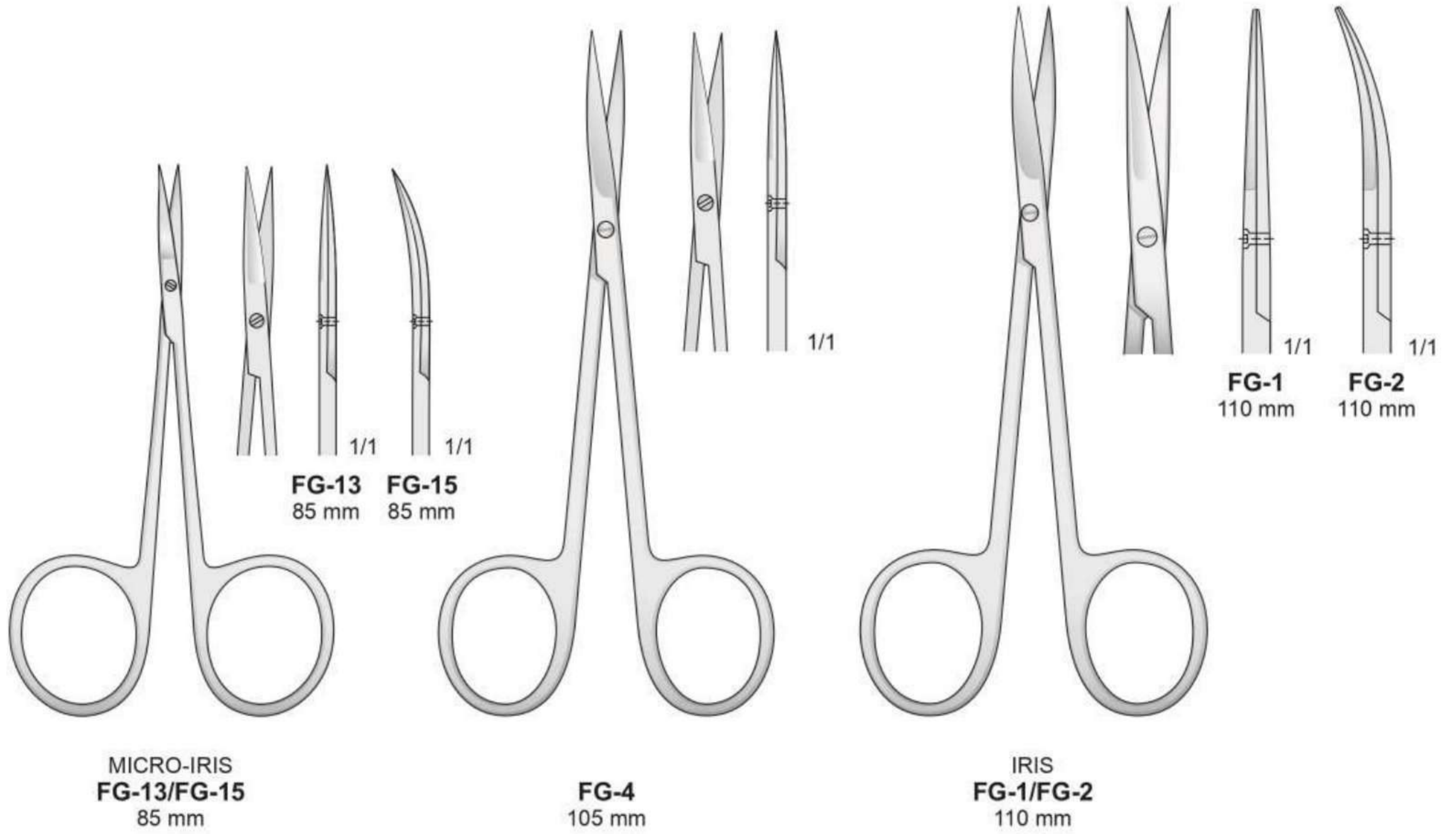

Spitz - Sharp
Acuta - Aguda
Pointu

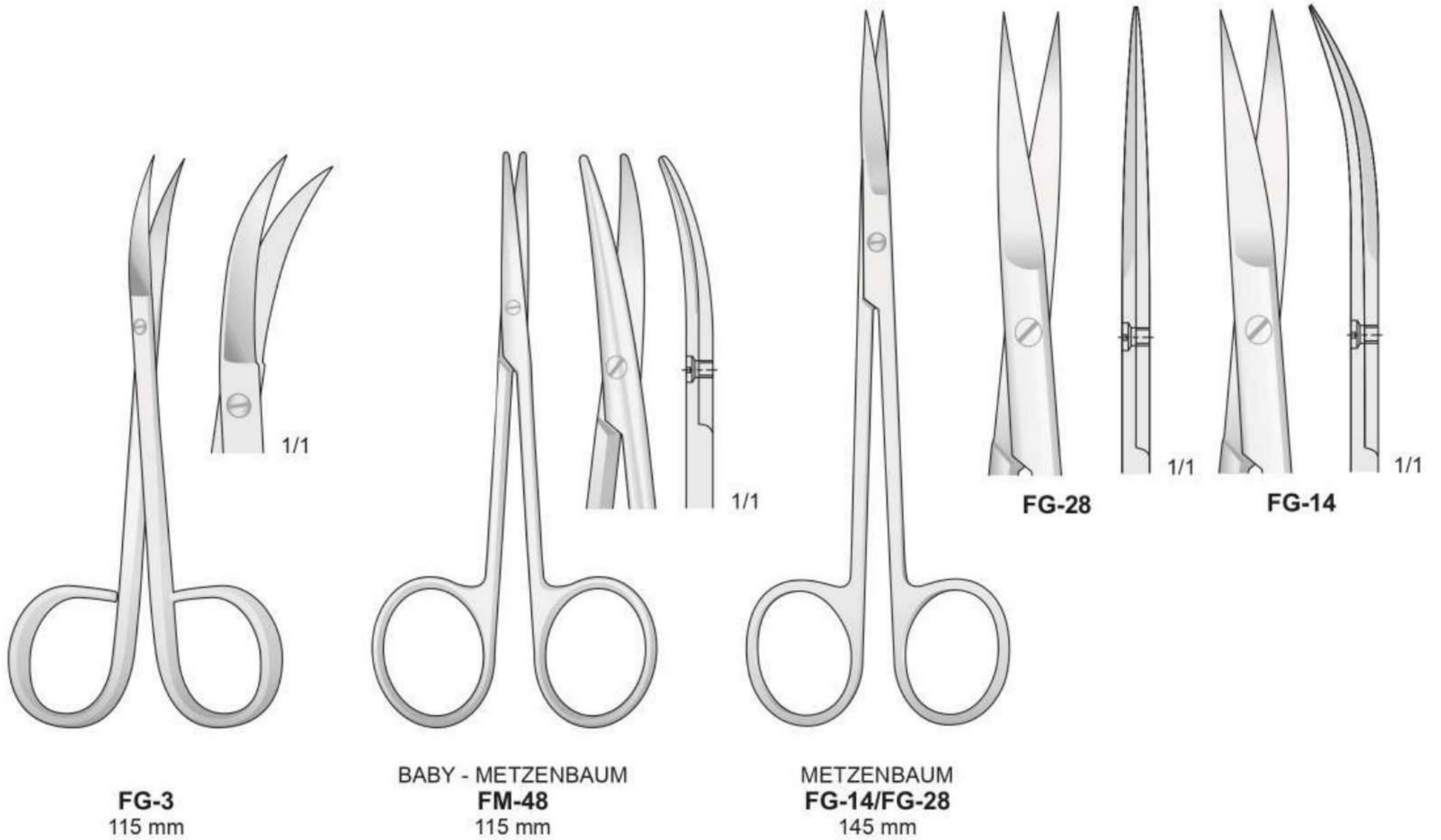

Feine Scheren

Delicate scissors

Forbici delicate

Tijeras finas

Ciseaux fines

Stumpf - Blunt - Smusse
Romas - Mousse

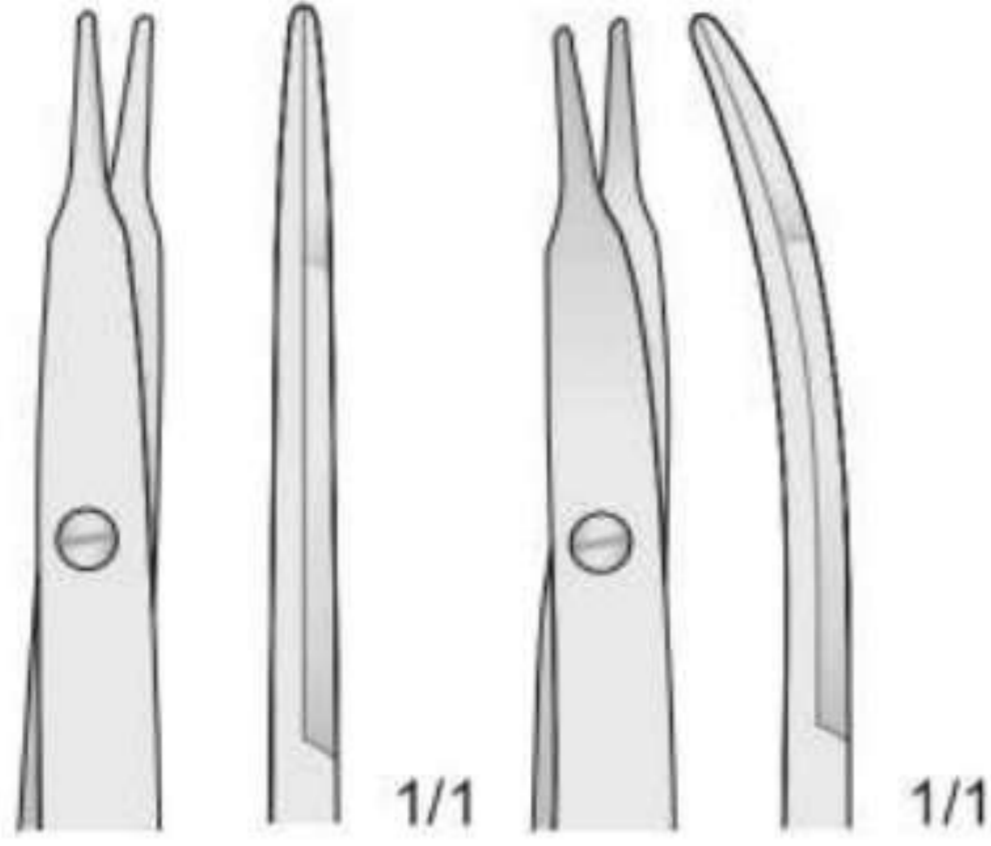

FG-50

FG-51

Spitz - Sharp - Acuta
Aguda - Pointu

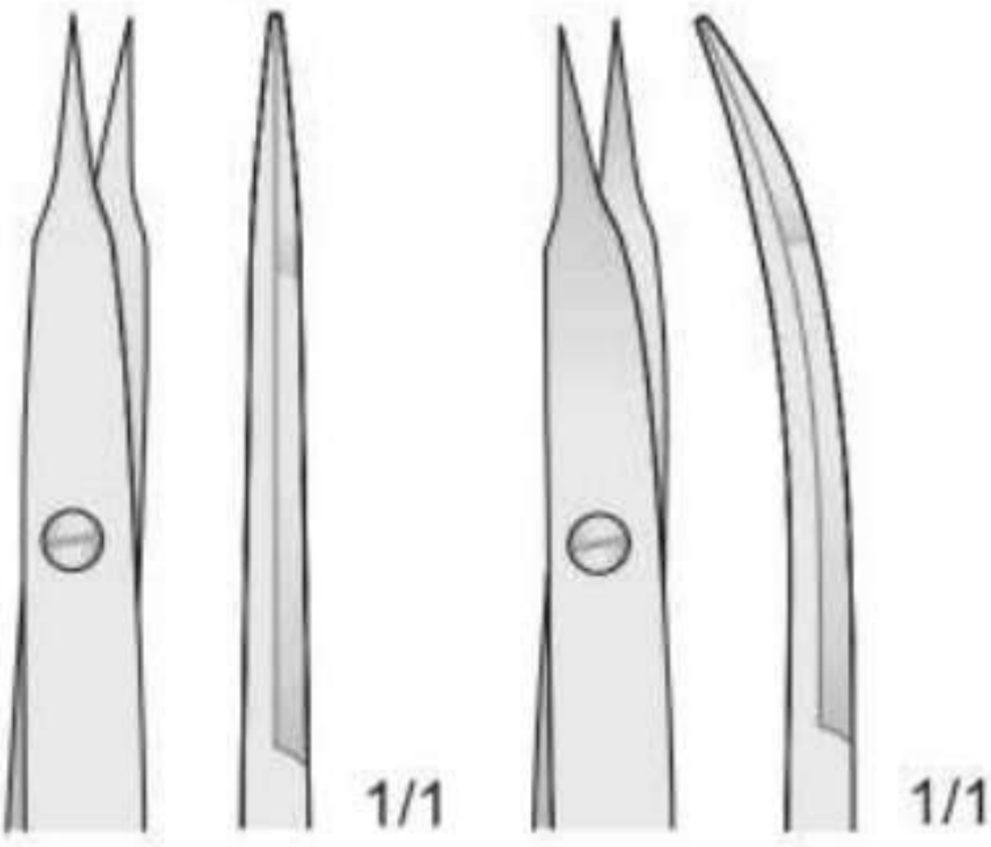

FG-52

FG-53

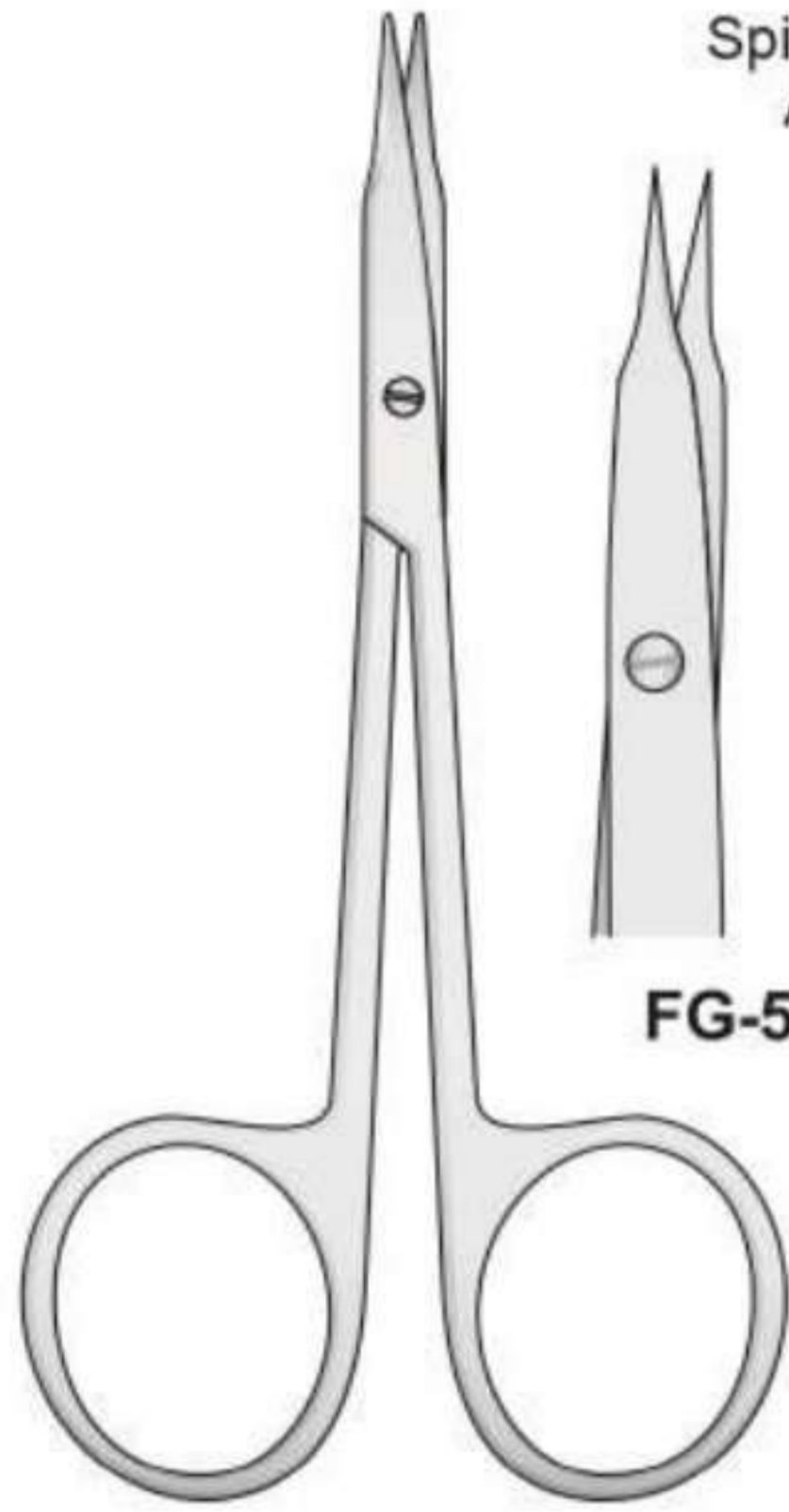

STEVENS
FG-50/FG-53
110 mm

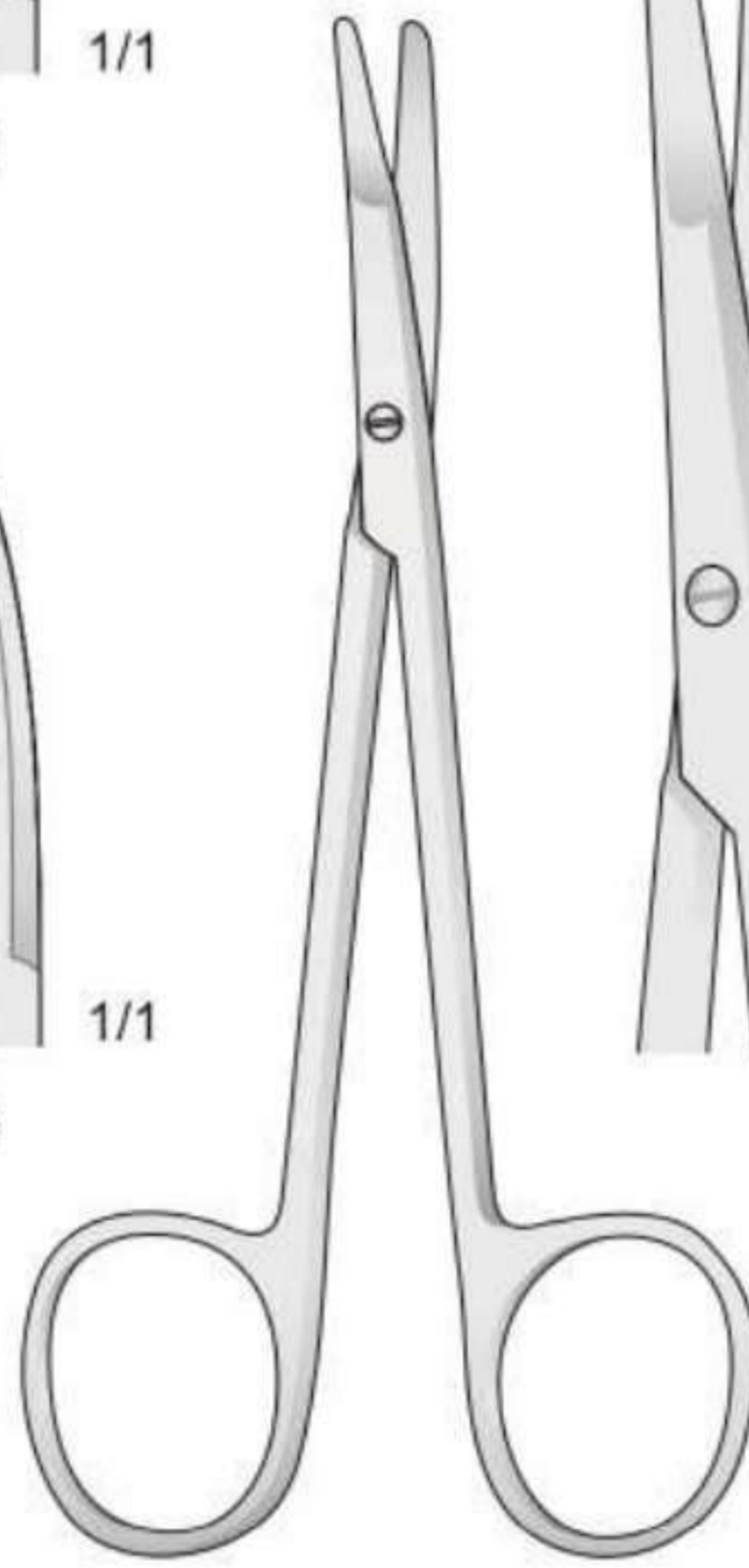

KILNER
FG-6C/FG-19R

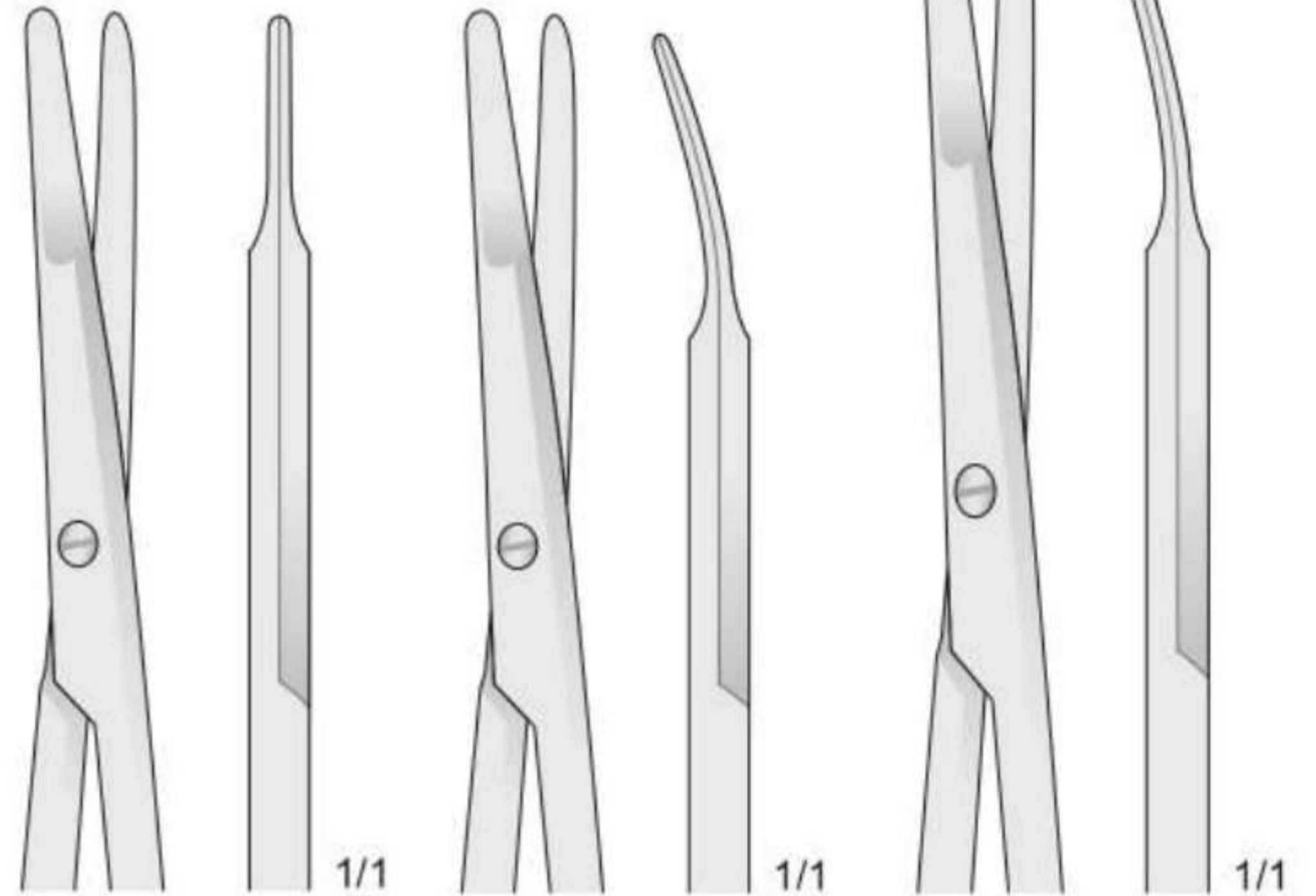

FG-19R
135 mm

FG-19C
135 mm

FG-6C
150 mm

Stumpf - Blunt - Smusse
Romas - Mousse

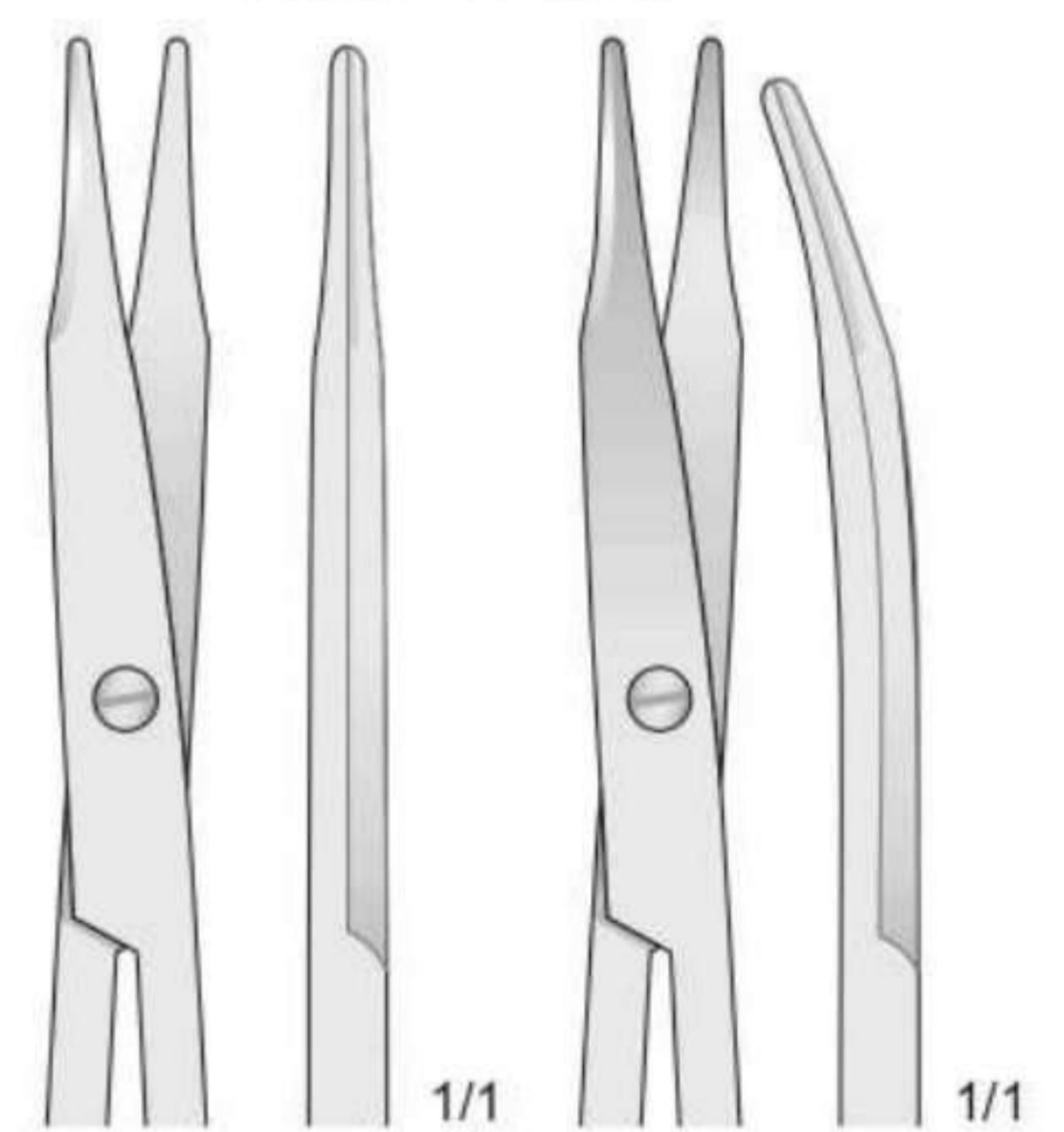

FG-54
150 mm

FG-55
150 mm

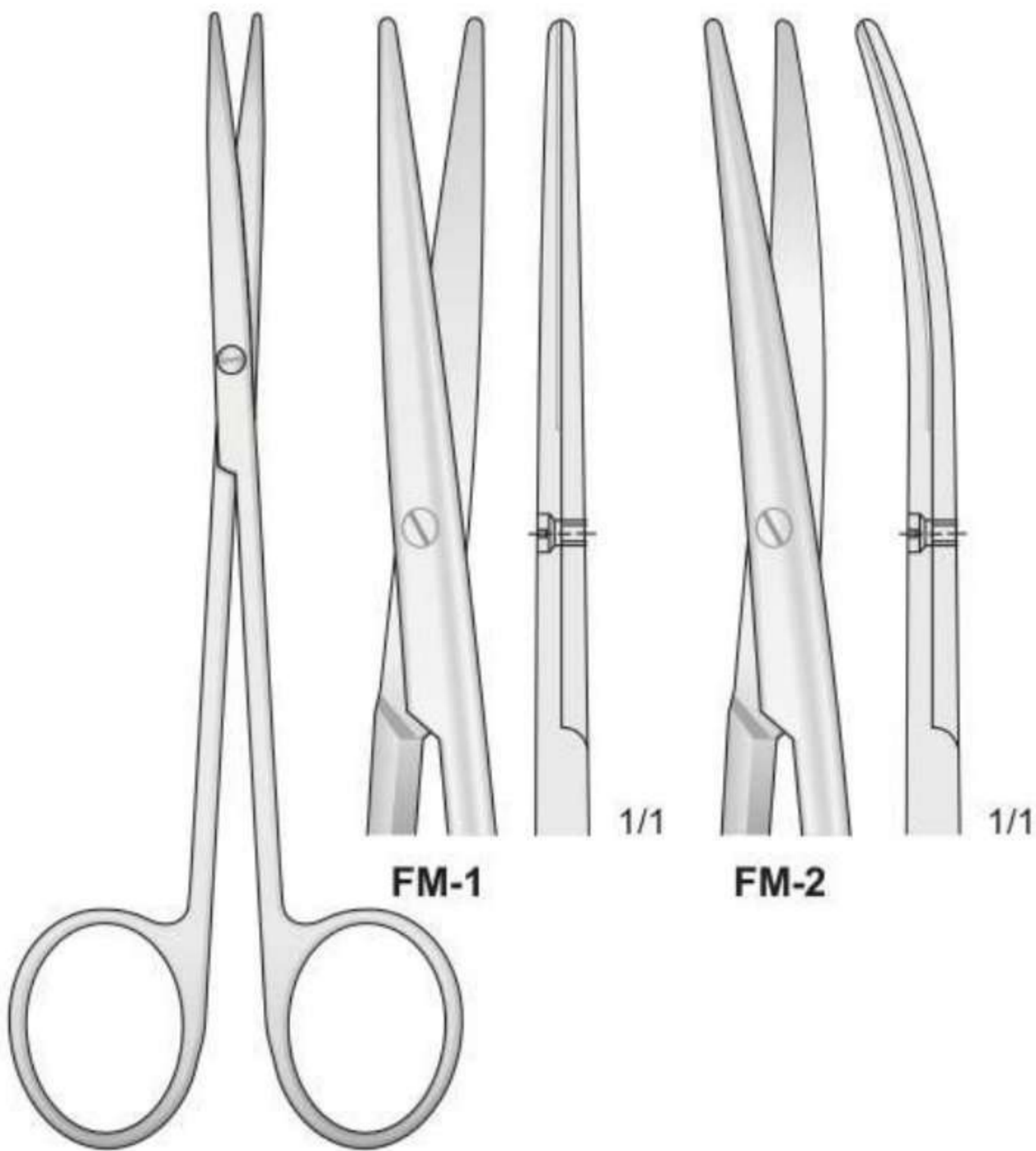

FM-1

FM-2

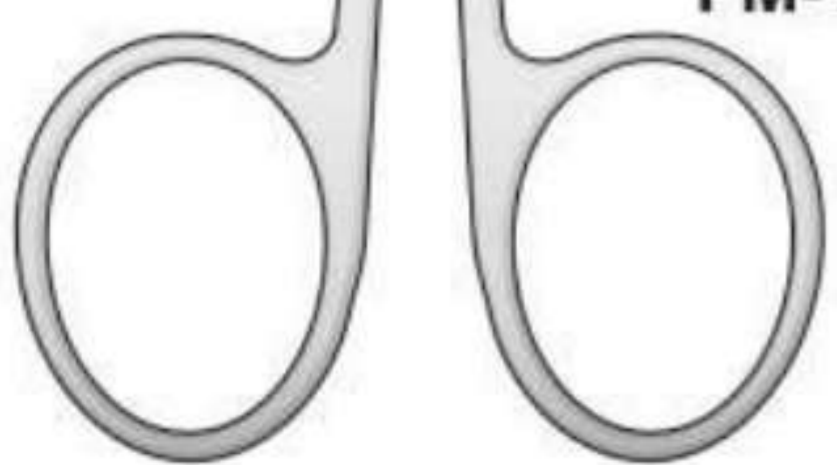

METZENBAUM
FM-1/FM-2
145 mm

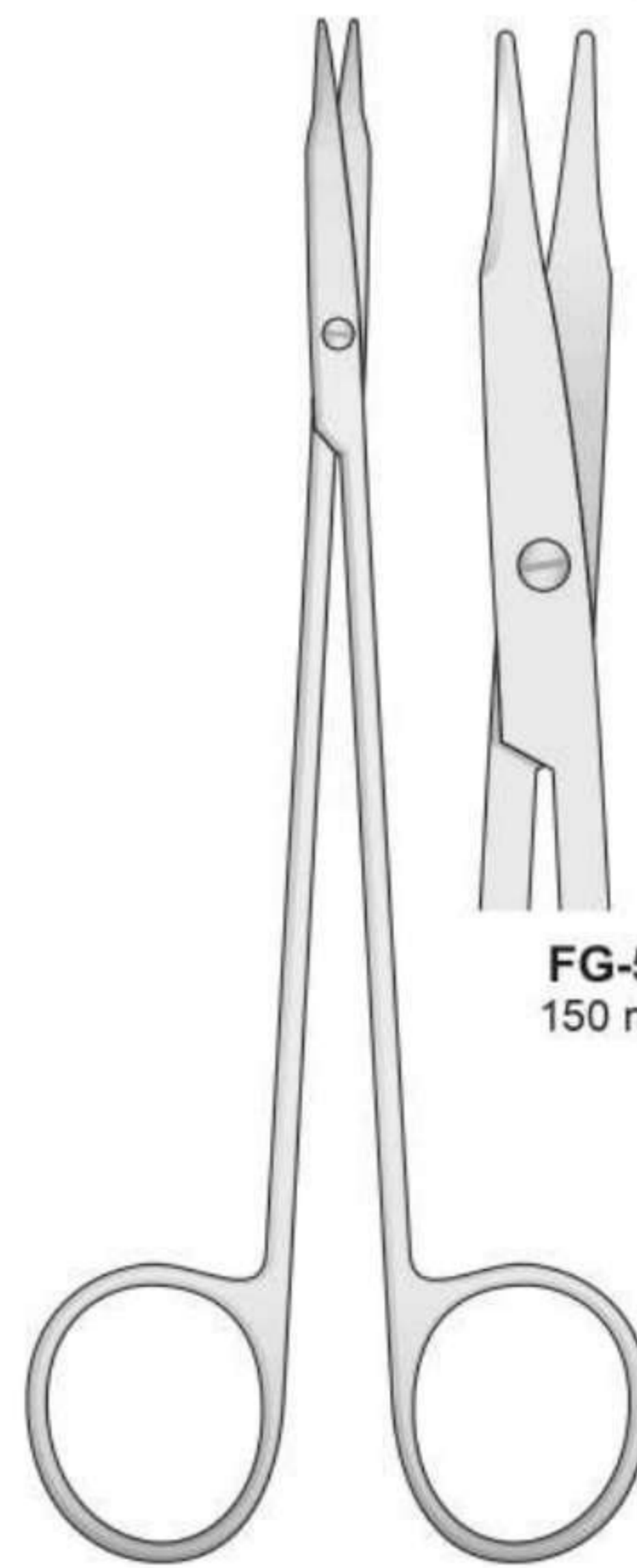

REYNOLDS
FG-54/FG-55

Mit Hartmetalleinsätzen - Tungsten-carbide scissors
Con punta al carburo di tungsteno - Tijeras de tungsteno
Avec plaquettes en carbure de tungstène

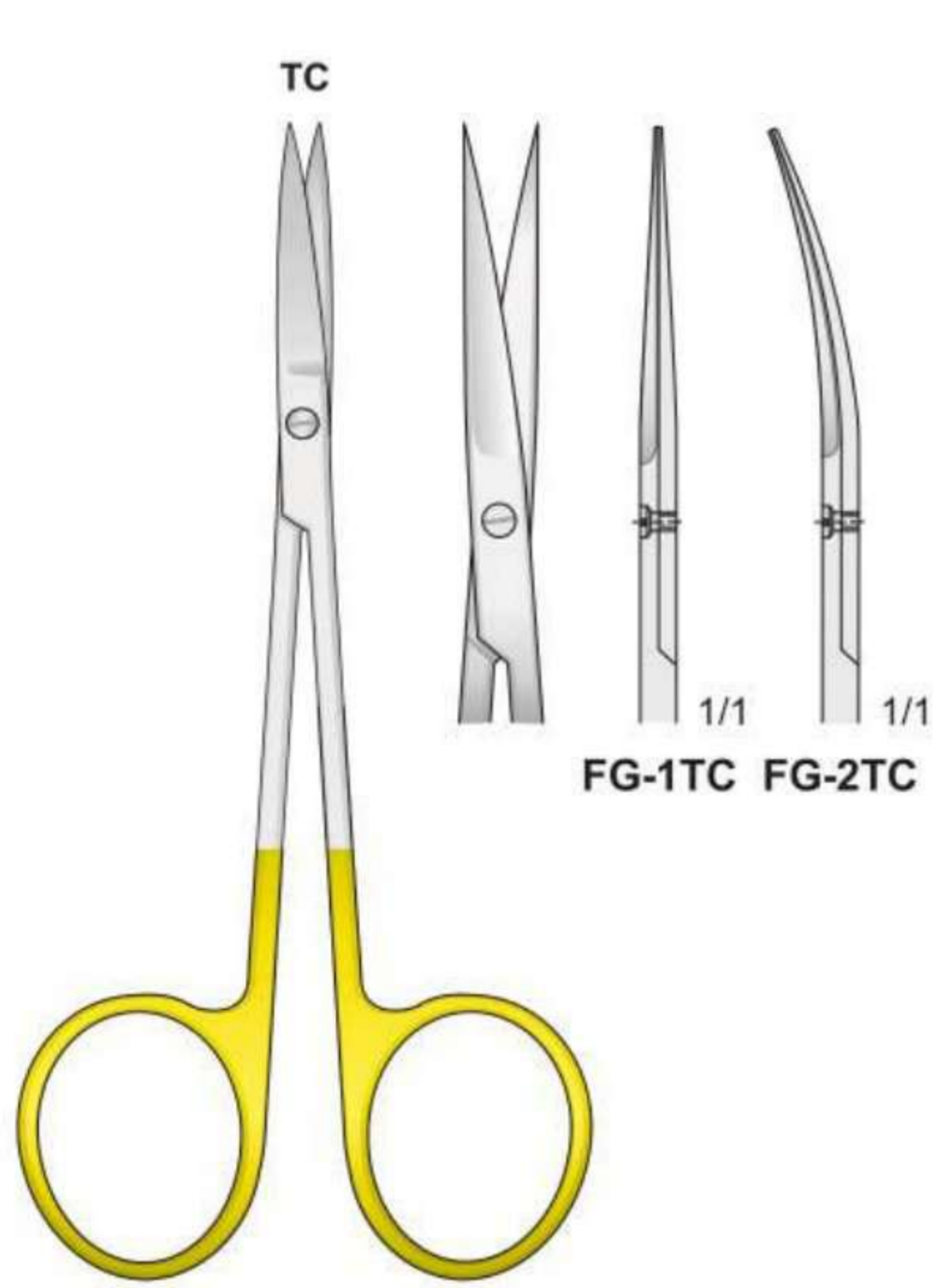

IRIS
FG1-TC/FG2-TC
115 mm

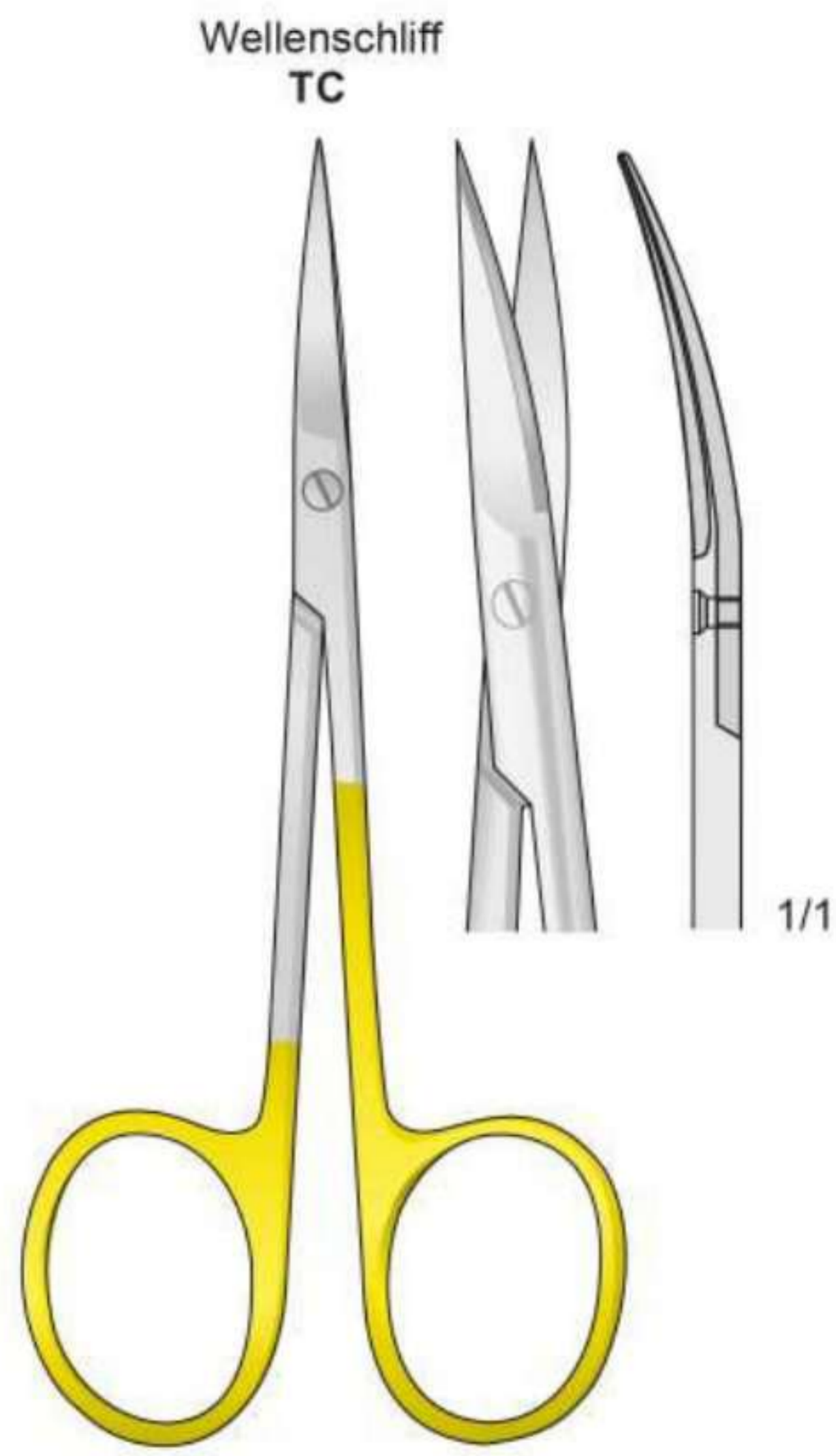

IRIS
FM-100
110 mm

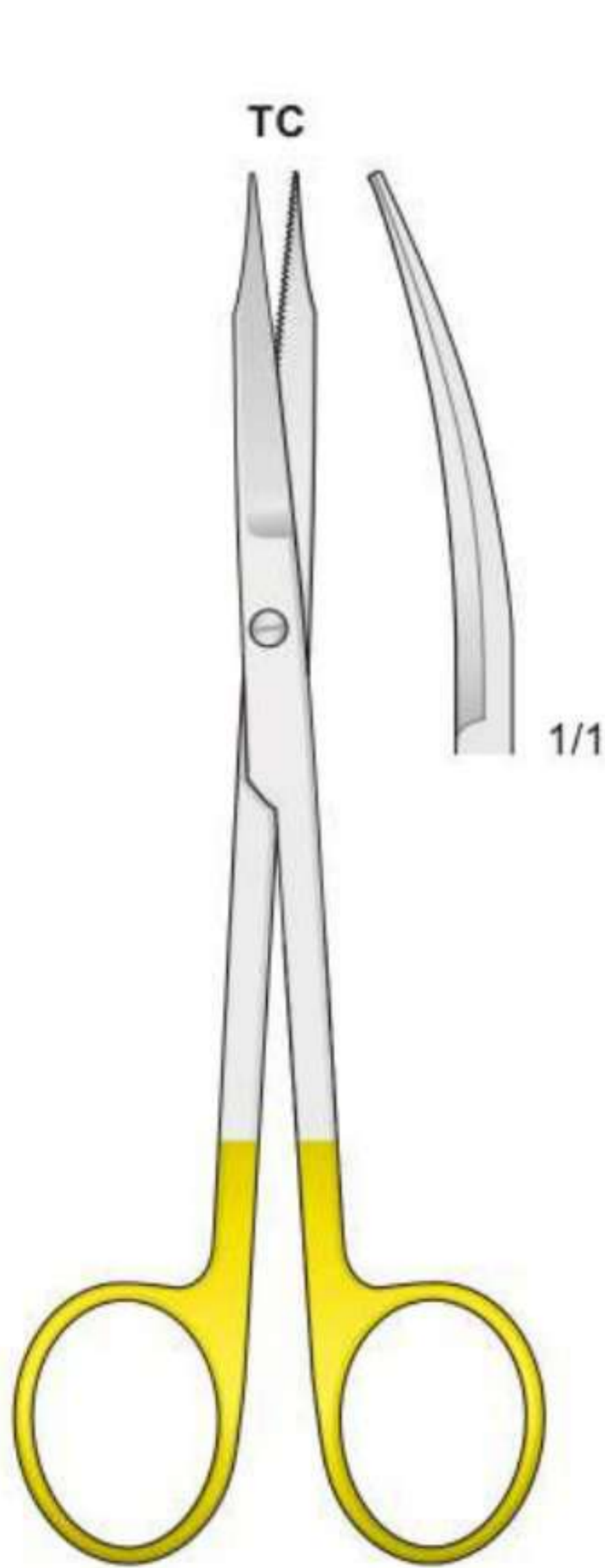

GOLDMAN-FOX
GFC-TC
135 mm

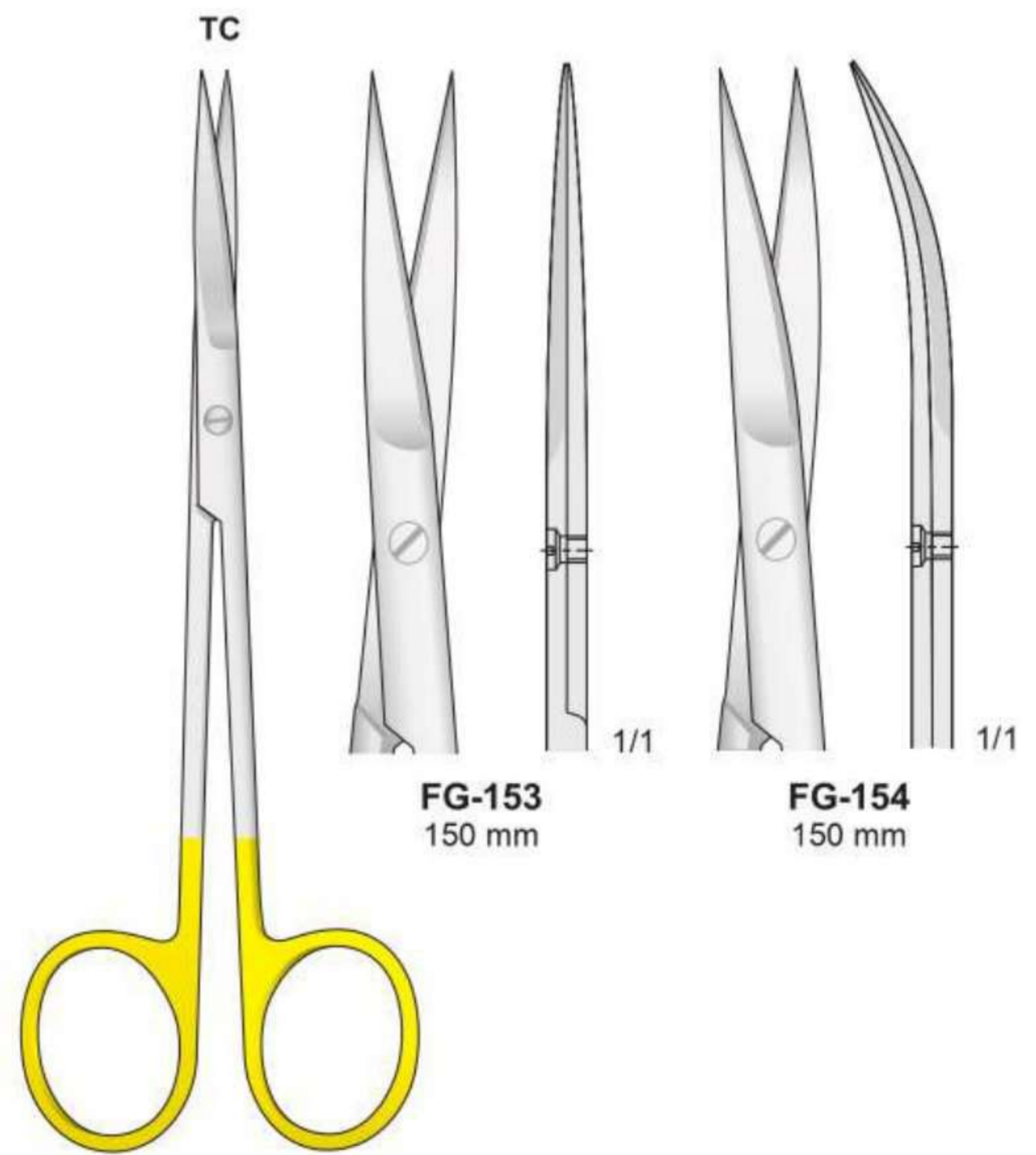

JOSEPH
FG-153/FG-154
150 mm

Mit Hartmetalleinsätzen - Tungsten-carbide scissors
Con punta al carburo di tungsteno - Tijeras de tungsteno
Avec plaquettes en carbure de tungstène

TC

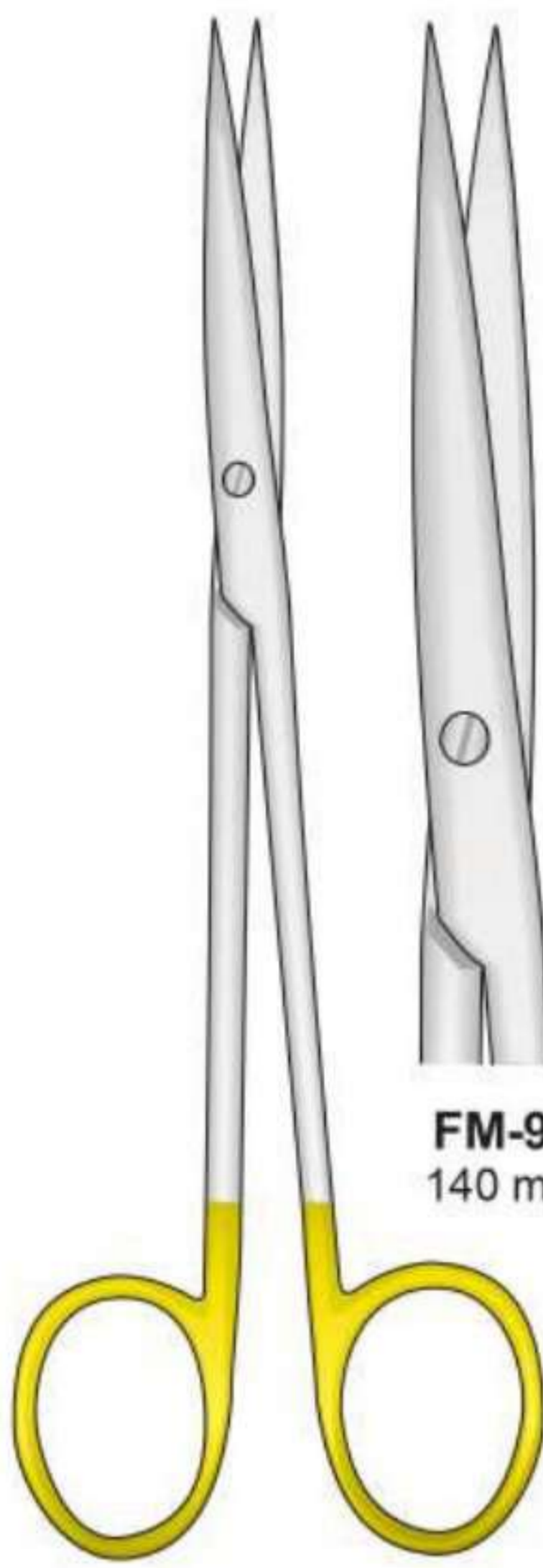

METZENBAUM-FINO
FM-96/FM-98

FM-96
140 mm

FM-98
140 mm

TC

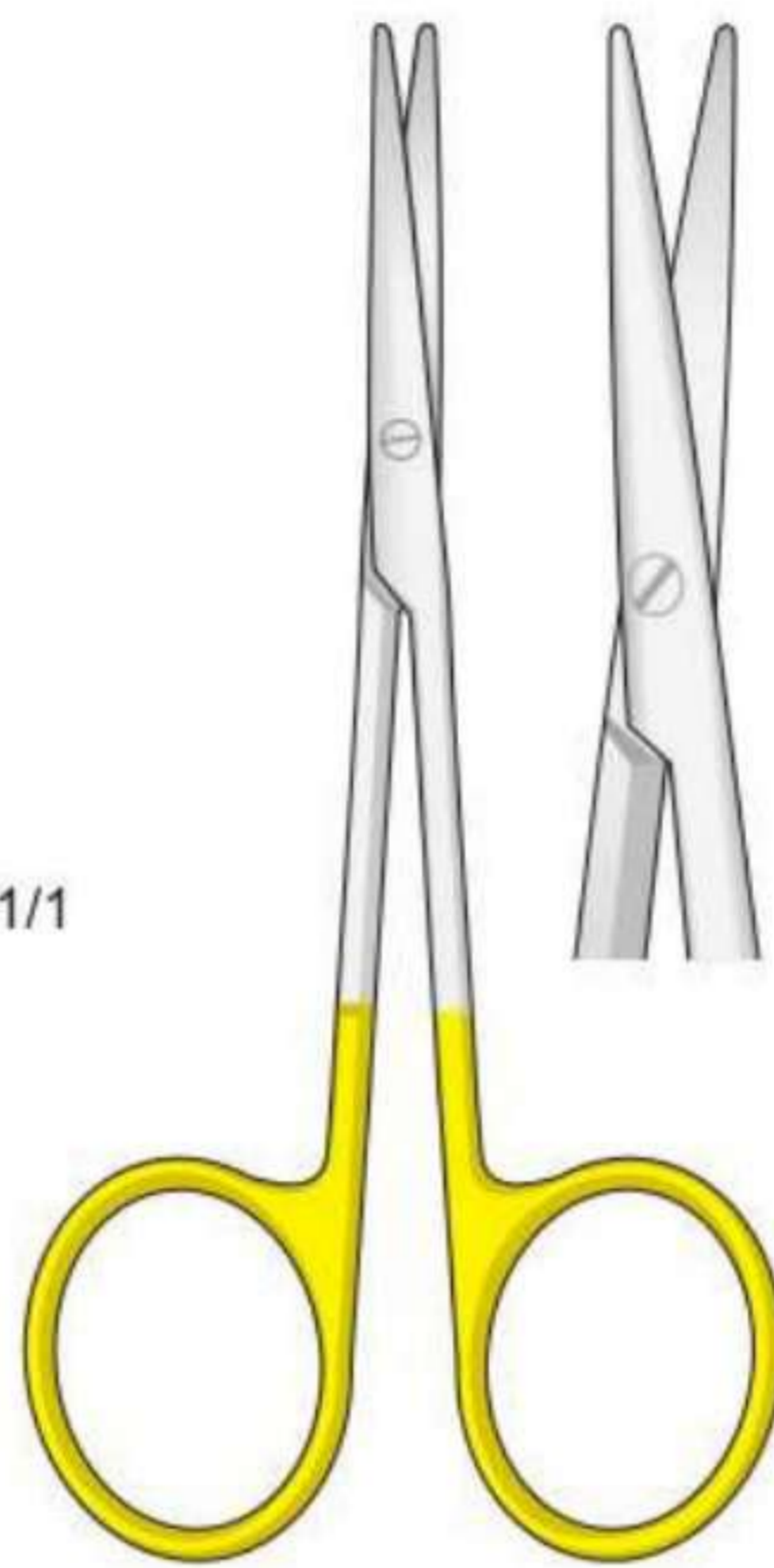

FM-118
115 mm

TC

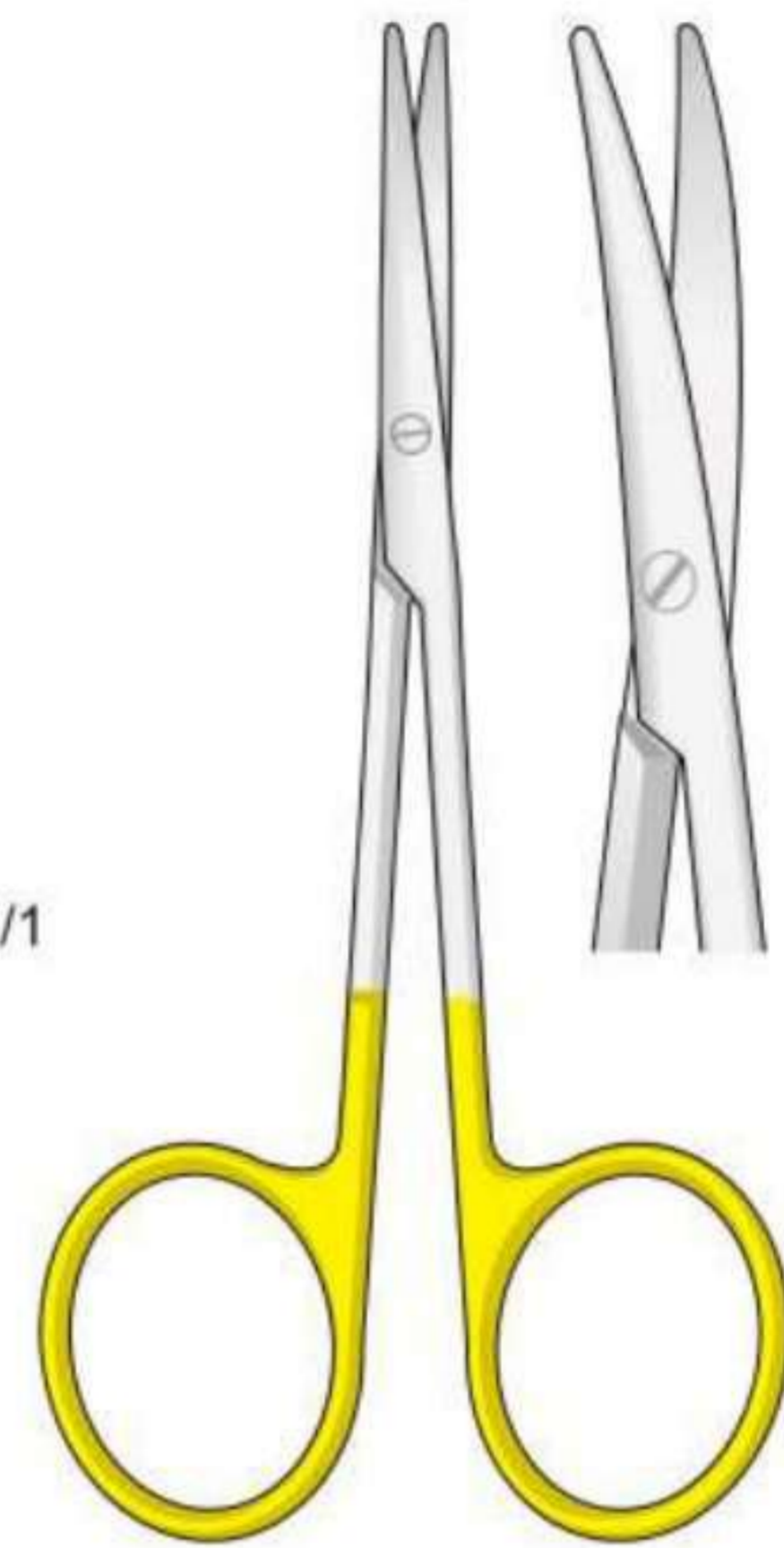

FM-119
115 mm

TC

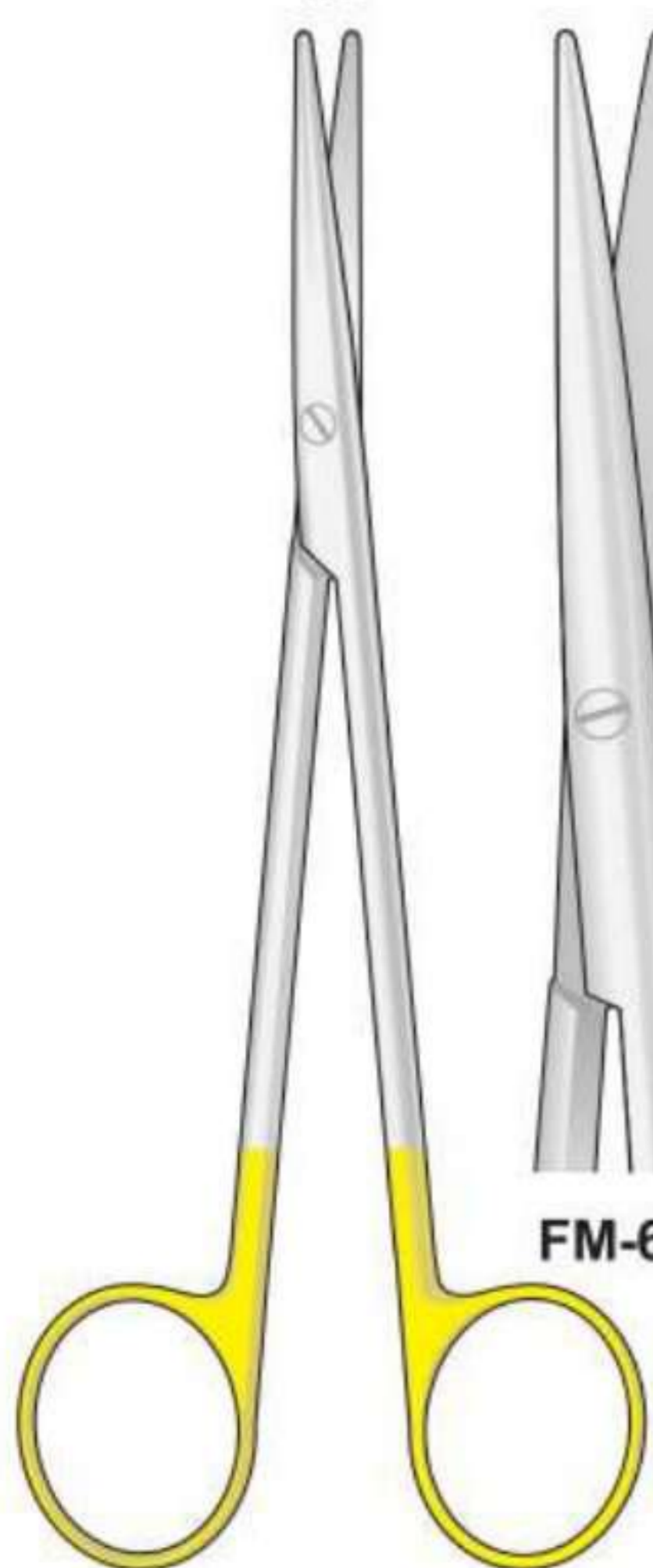

METZENBAUM
FM-66/FM-67
145 mm

FM-66

FM-67

TC

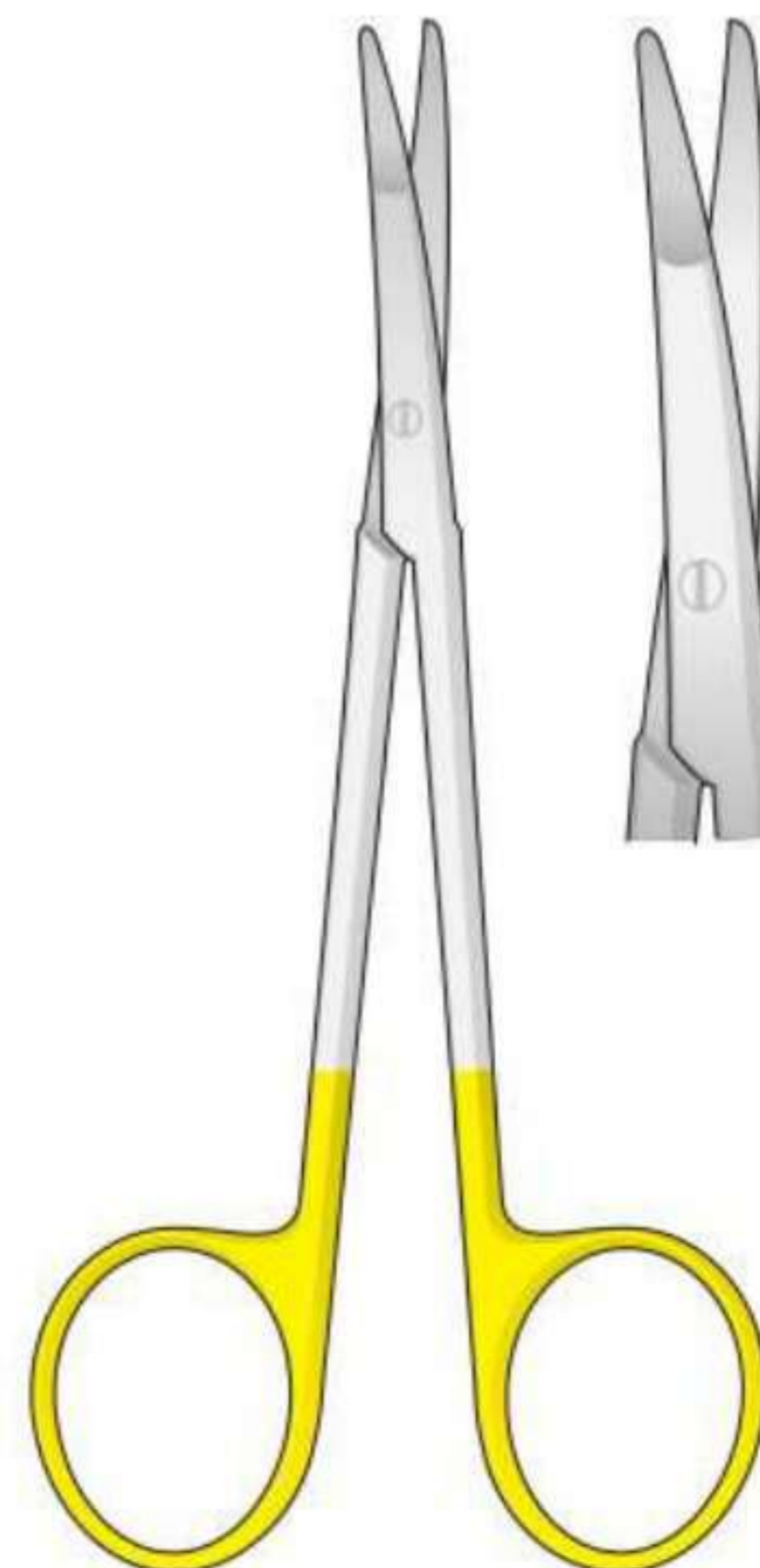

KILNER (RAGNELL)
FM-350
125 mm



FM-46
185 mm

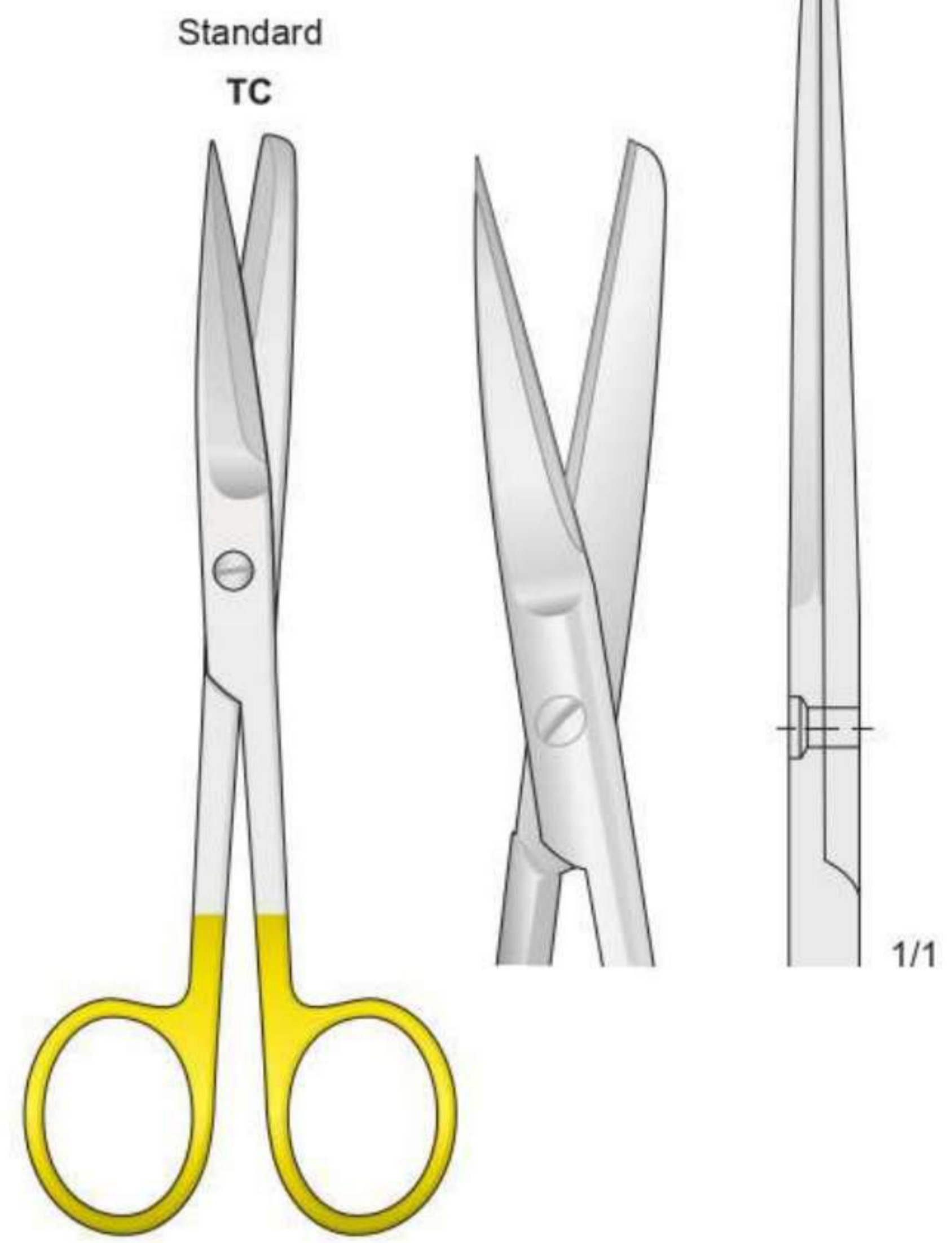

FM-51
145 mm

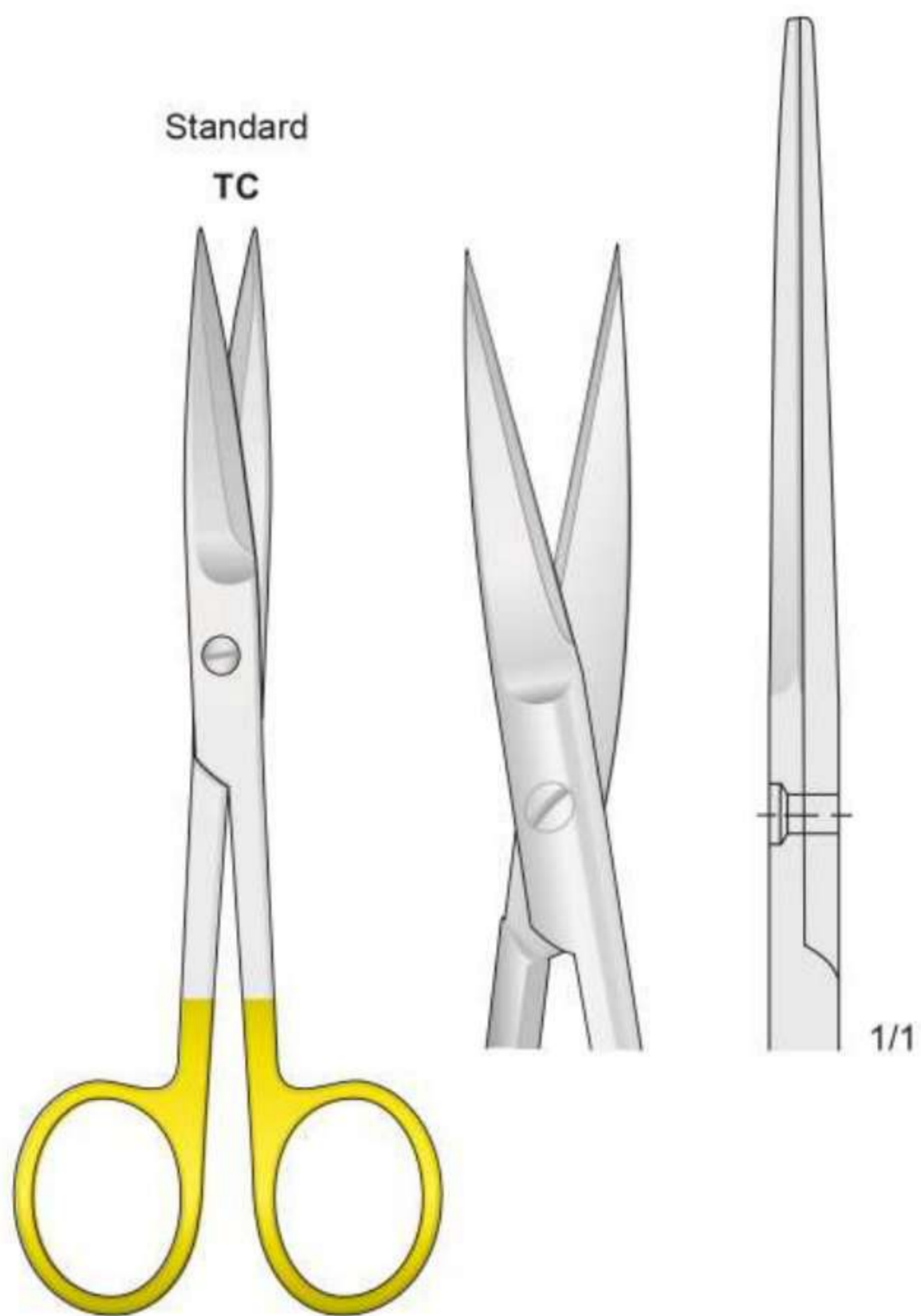

FM-59
145 mm

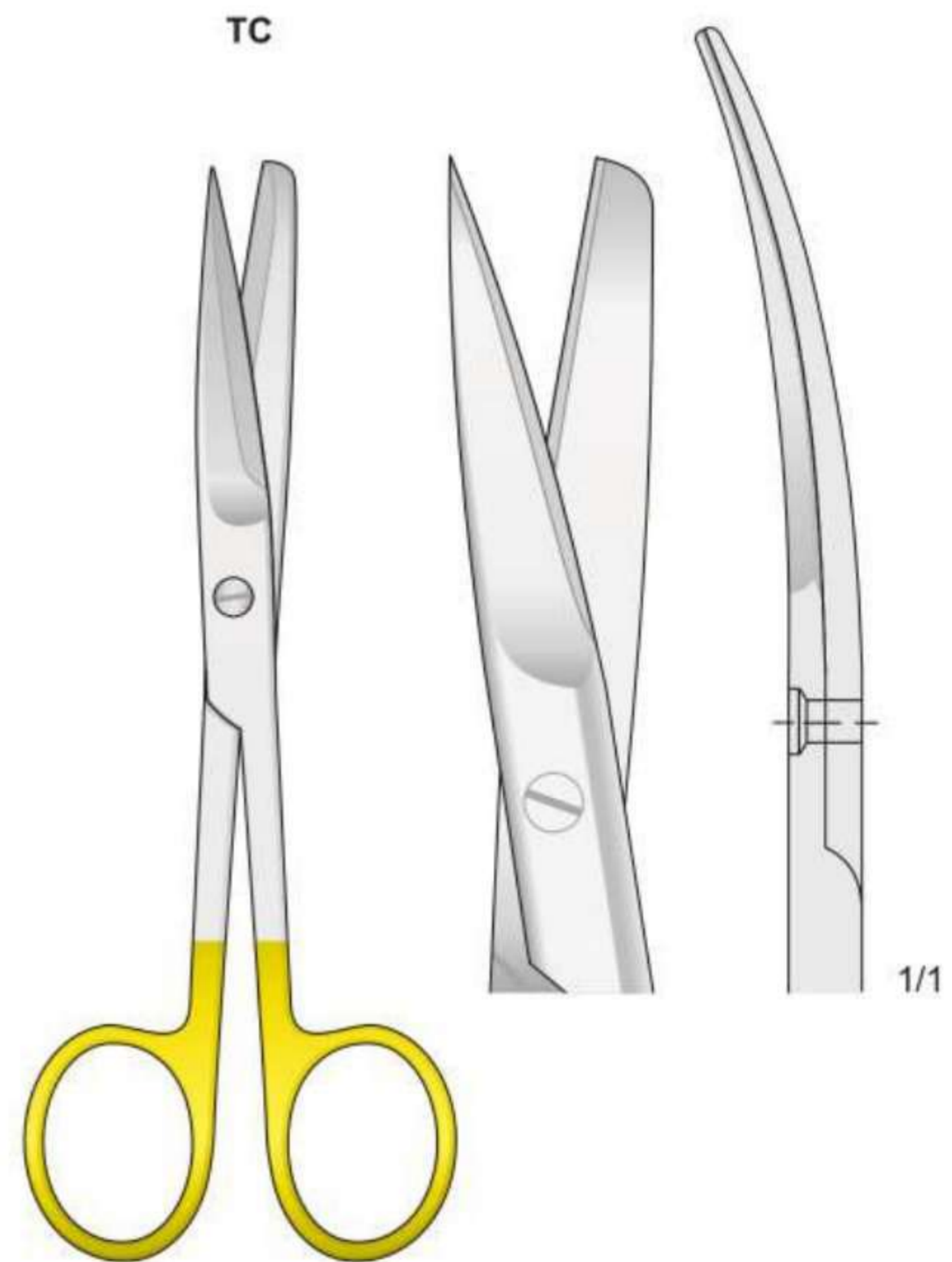

FM-149
145 mm

Chirurgische Pinzetten

Tissue Forceps

Pinzette chirurgiche

Pinzas quirúrgicas

Pinces à tissus

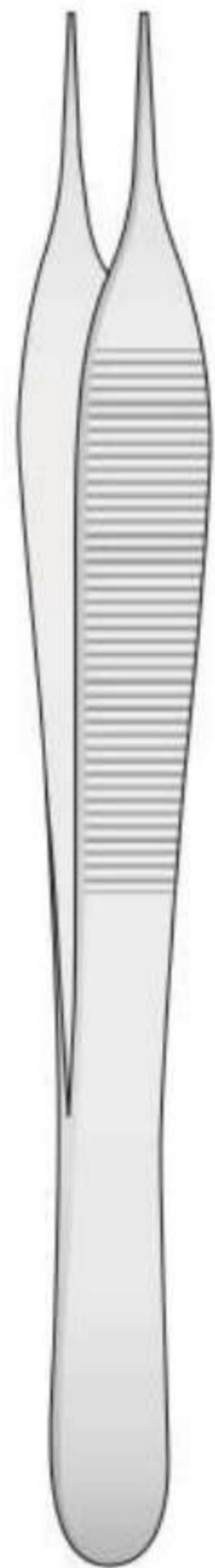

ADSON
BD-30/BD-73

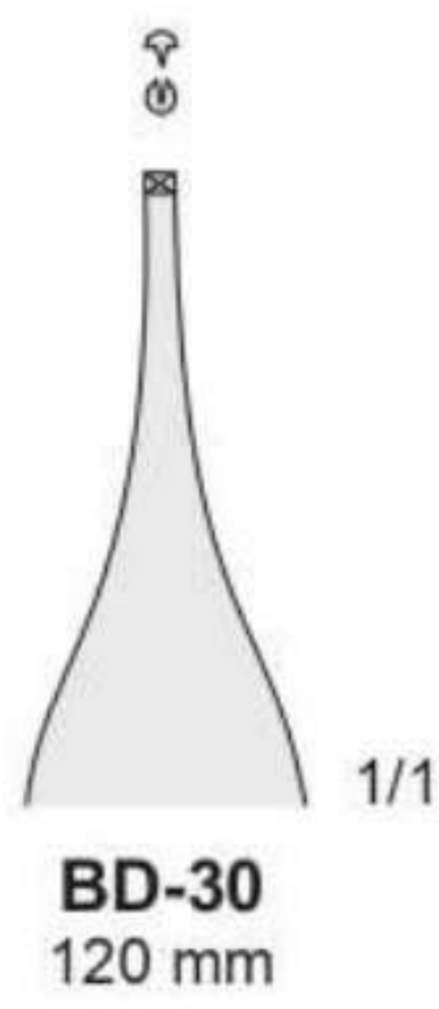

BD-30
120 mm

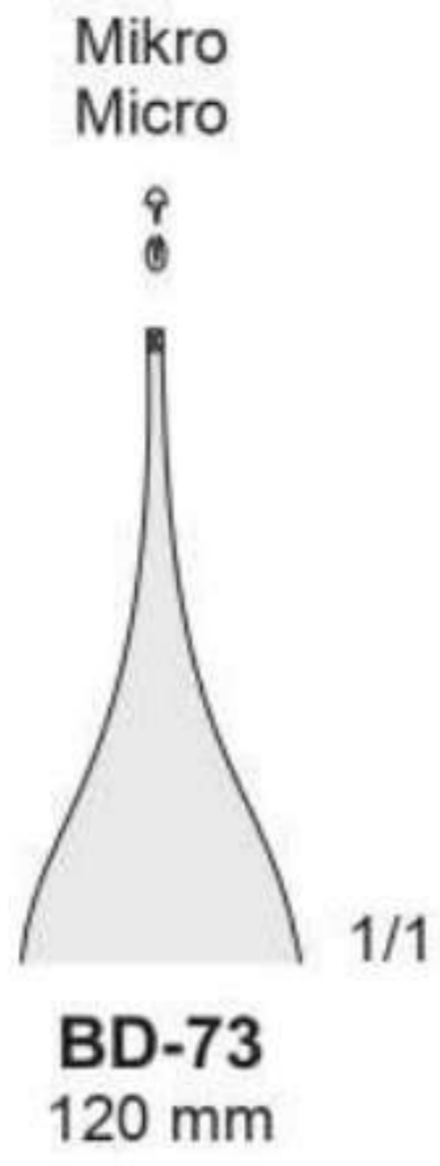

BD-73
120 mm

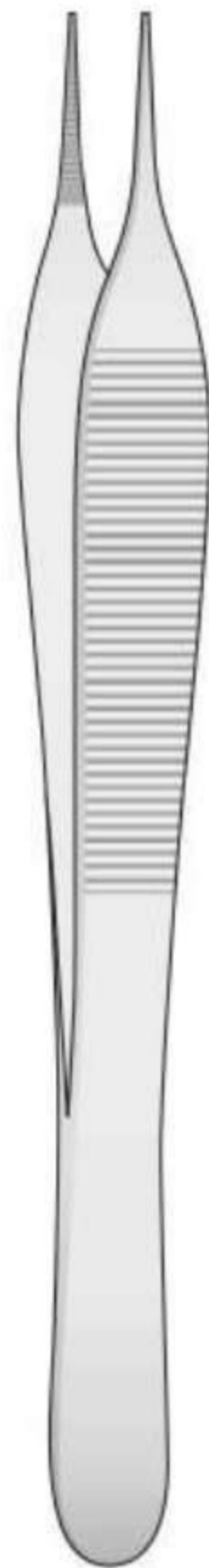

ADSON
BD-31/BD-71

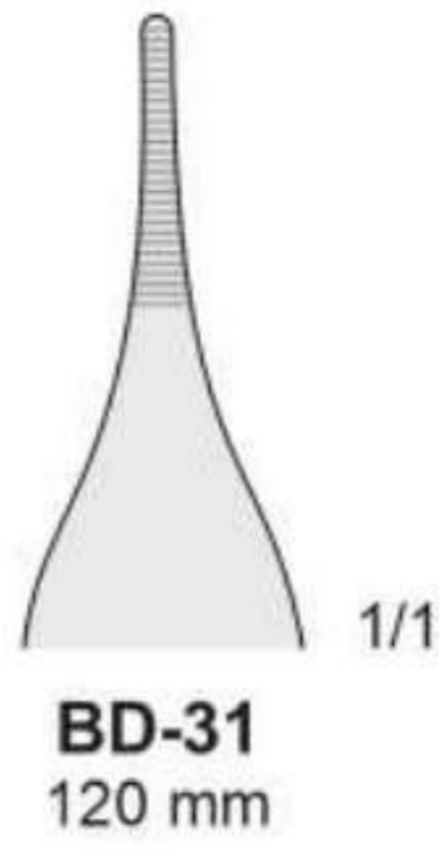

BD-31
120 mm

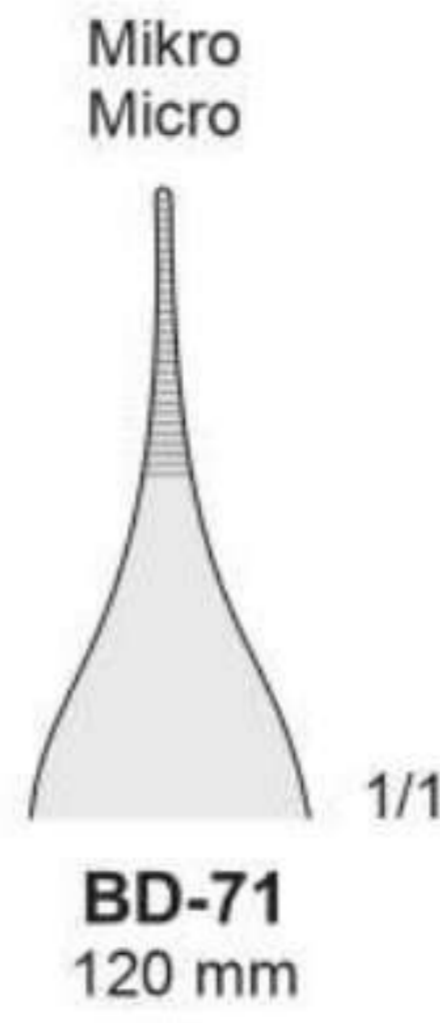

BD-71
120 mm



ADSON
BD-90
120 mm

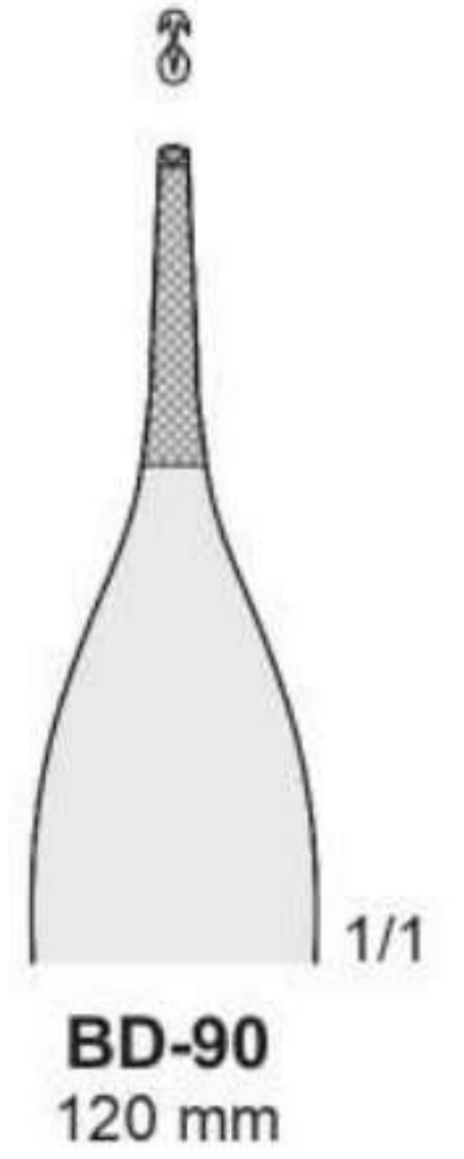

BD-90
120 mm

6 x 6 Zähne - 6 x 6 Teeths
6 x 6 Denti - 6 x 6 Dientes
6 x 6 Dents

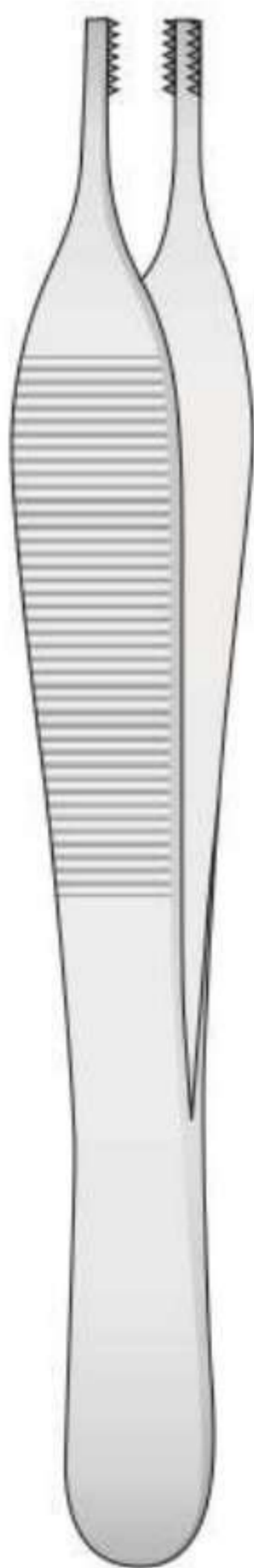

ADSON-BROWN
BD-92
120 mm

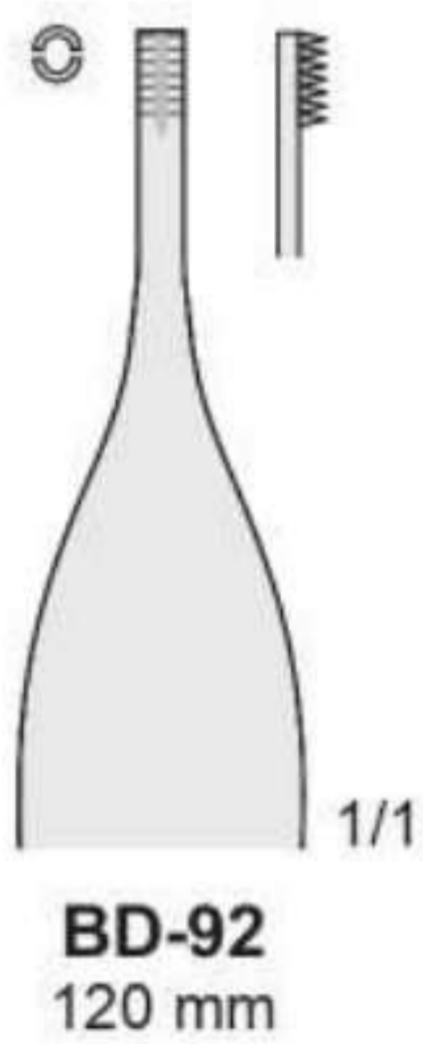

BD-92
120 mm

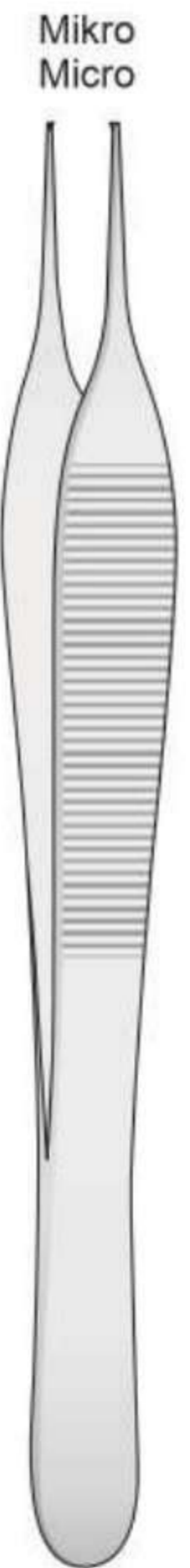

ADSON
BD-70/BD-178
150 mm

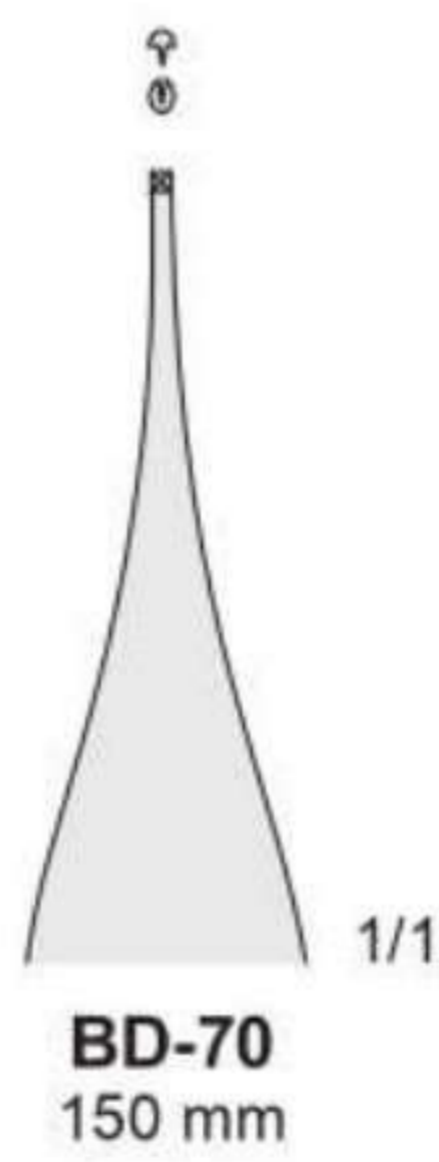

BD-70
150 mm

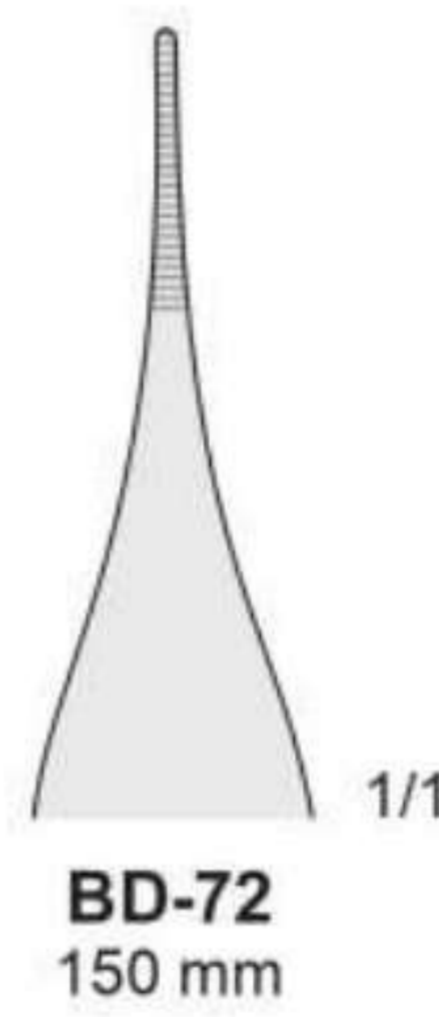

BD-72
150 mm

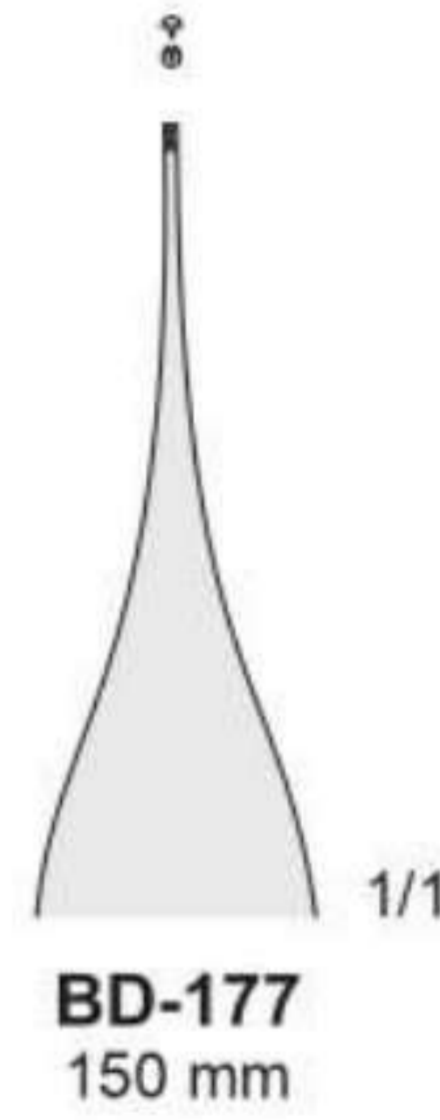

BD-177
150 mm

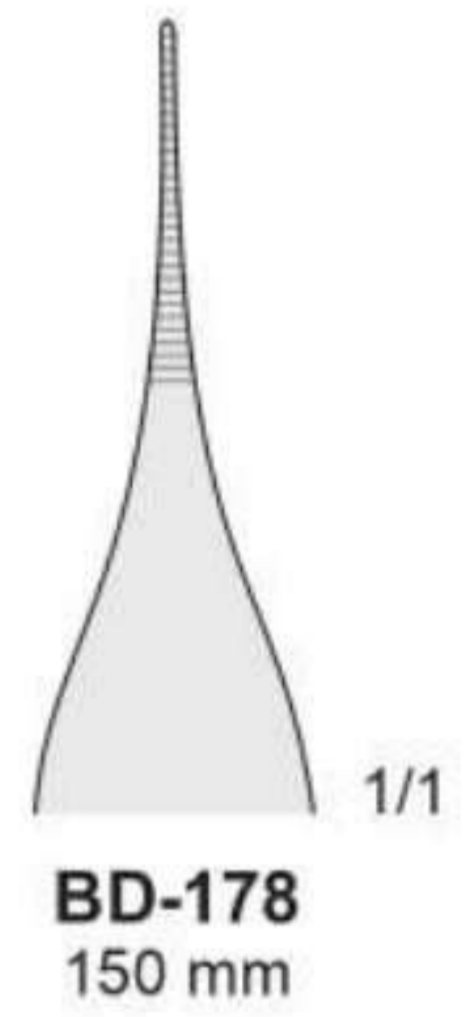

BD-178
150 mm

Mikro Pinzetten

Delicate Forceps

Micro pinzette

Micro pinzas

Micro pinces

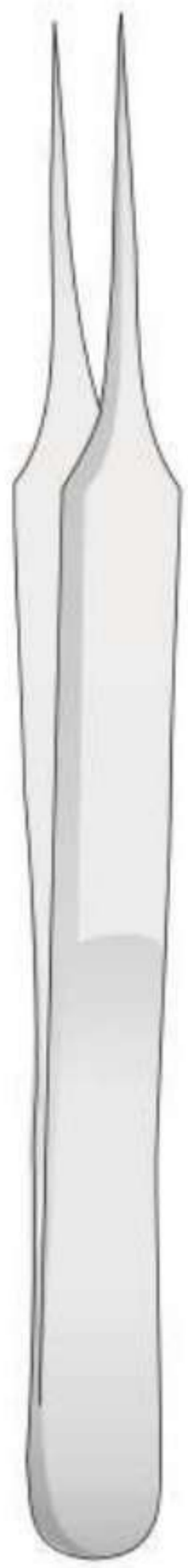

BD-60/BD-62
110 mm

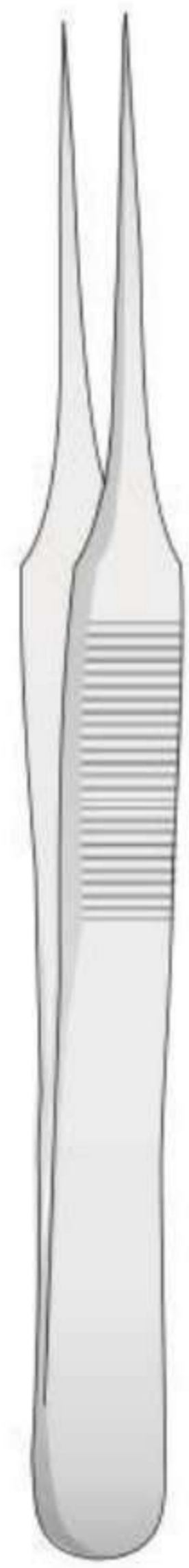
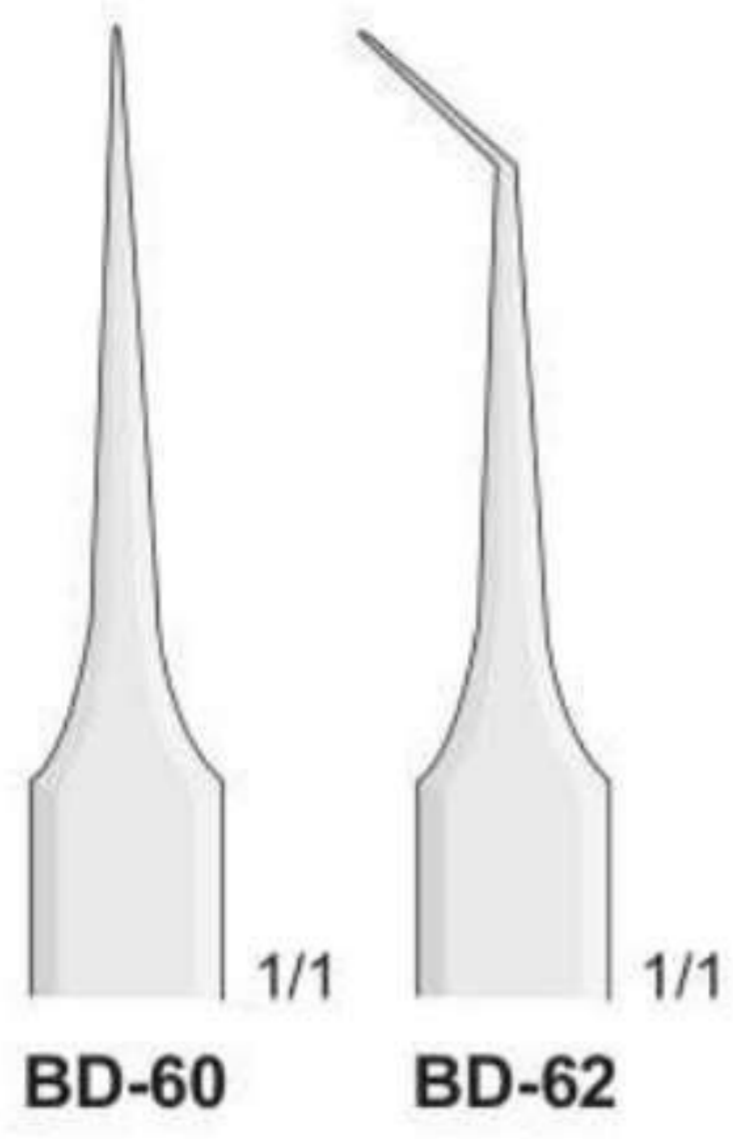

BD-64/BD-66
110 mm

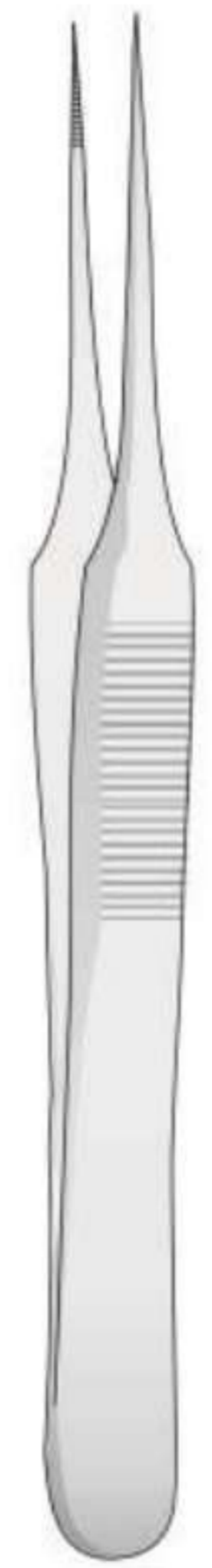
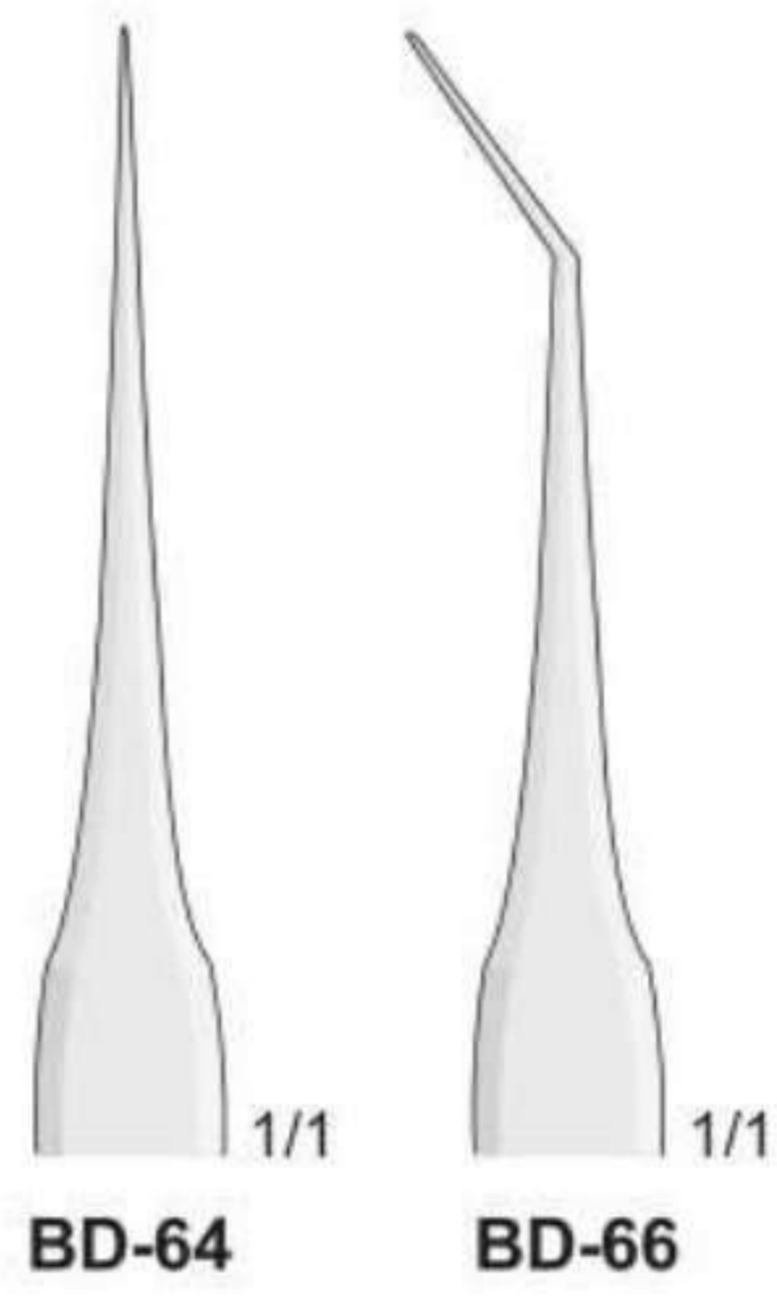

BD-68
90 mm

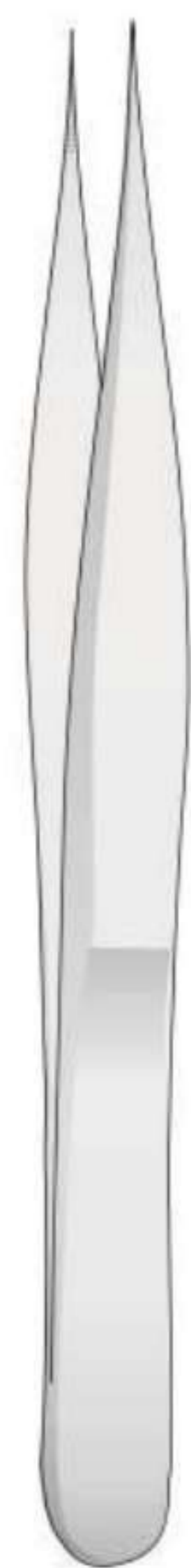
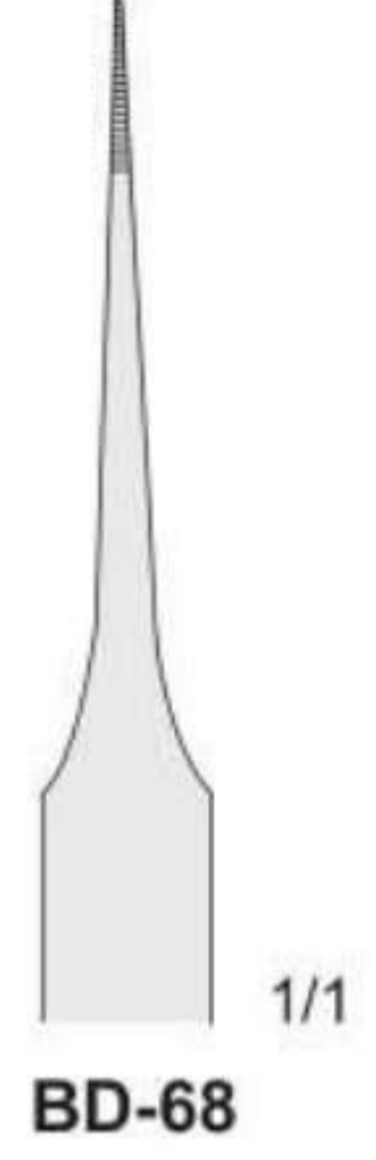

BD-200/BD-203

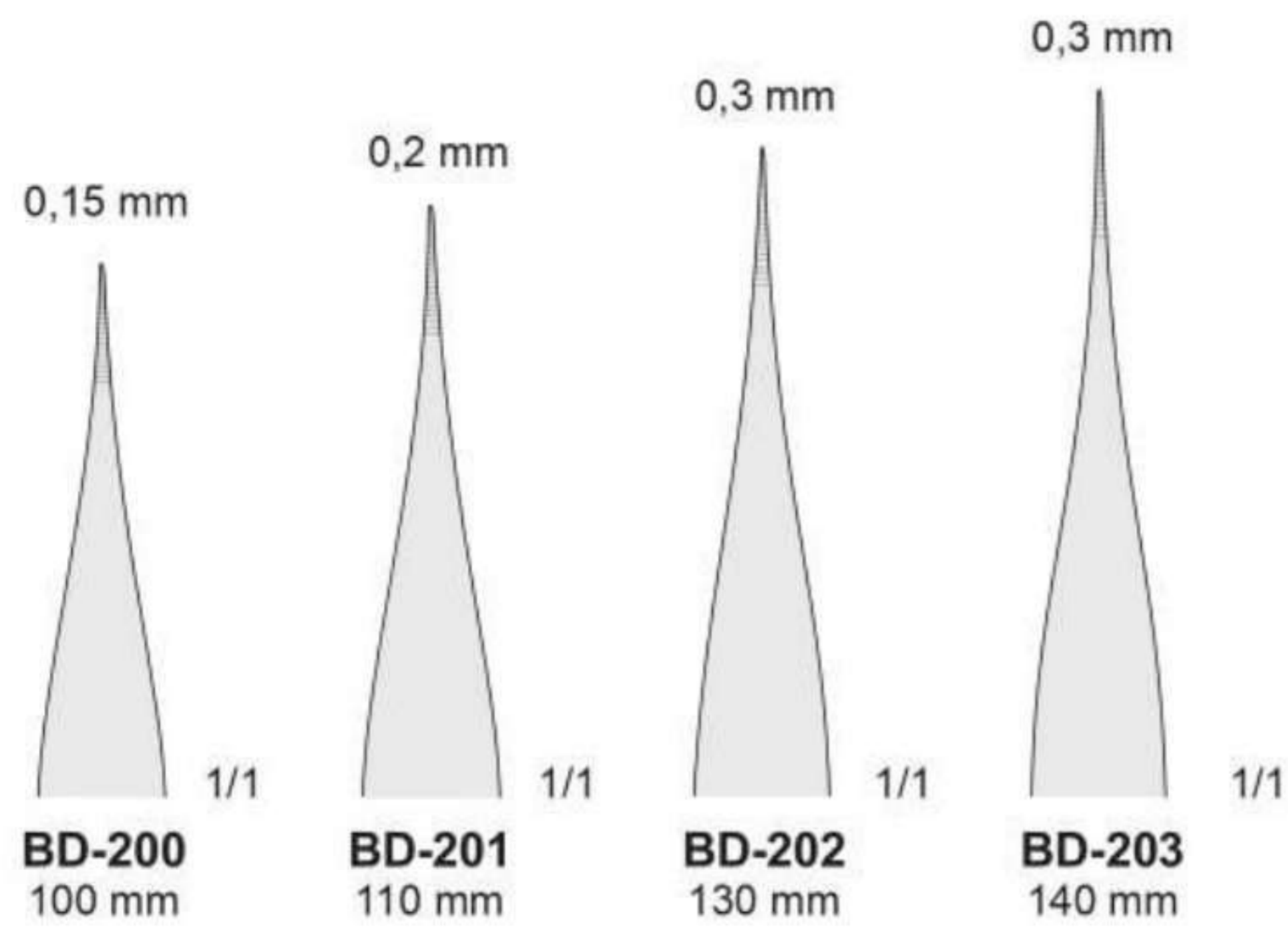

BD-205
115 mm



BD-206
115 mm

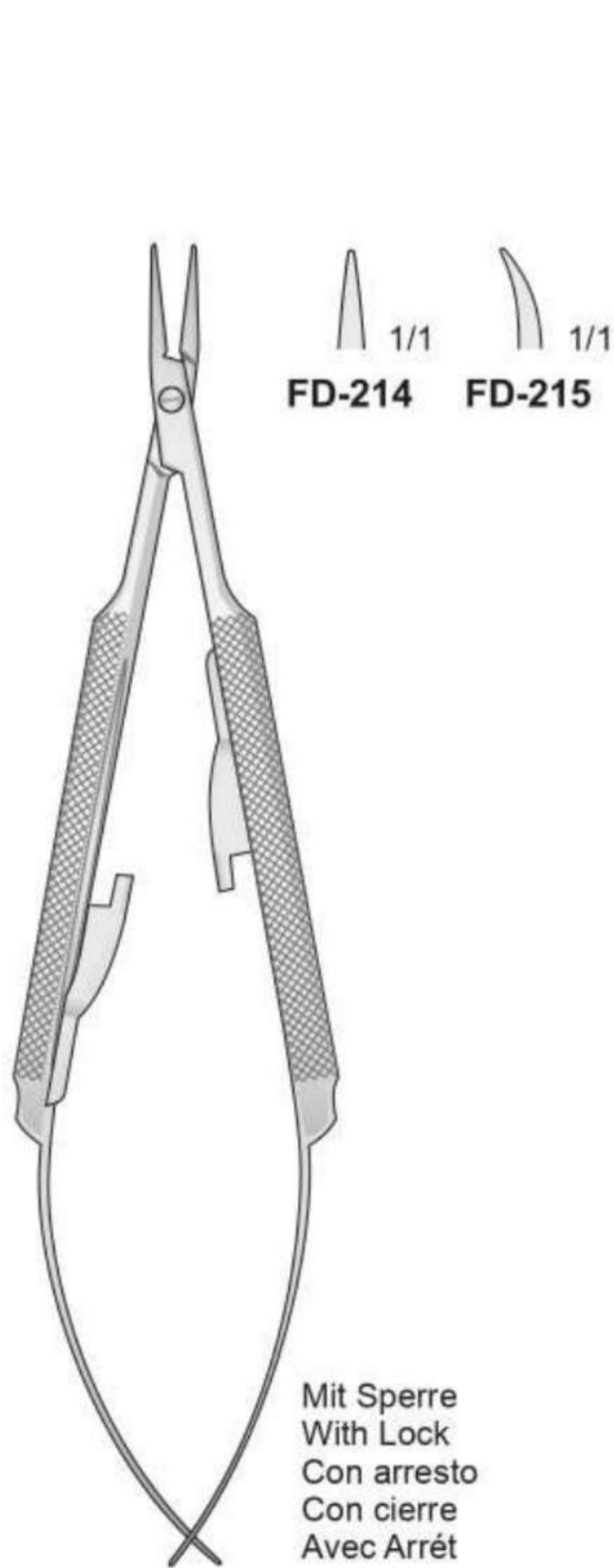

**BARRAQUER
FD-214/FD-215**
125 mm

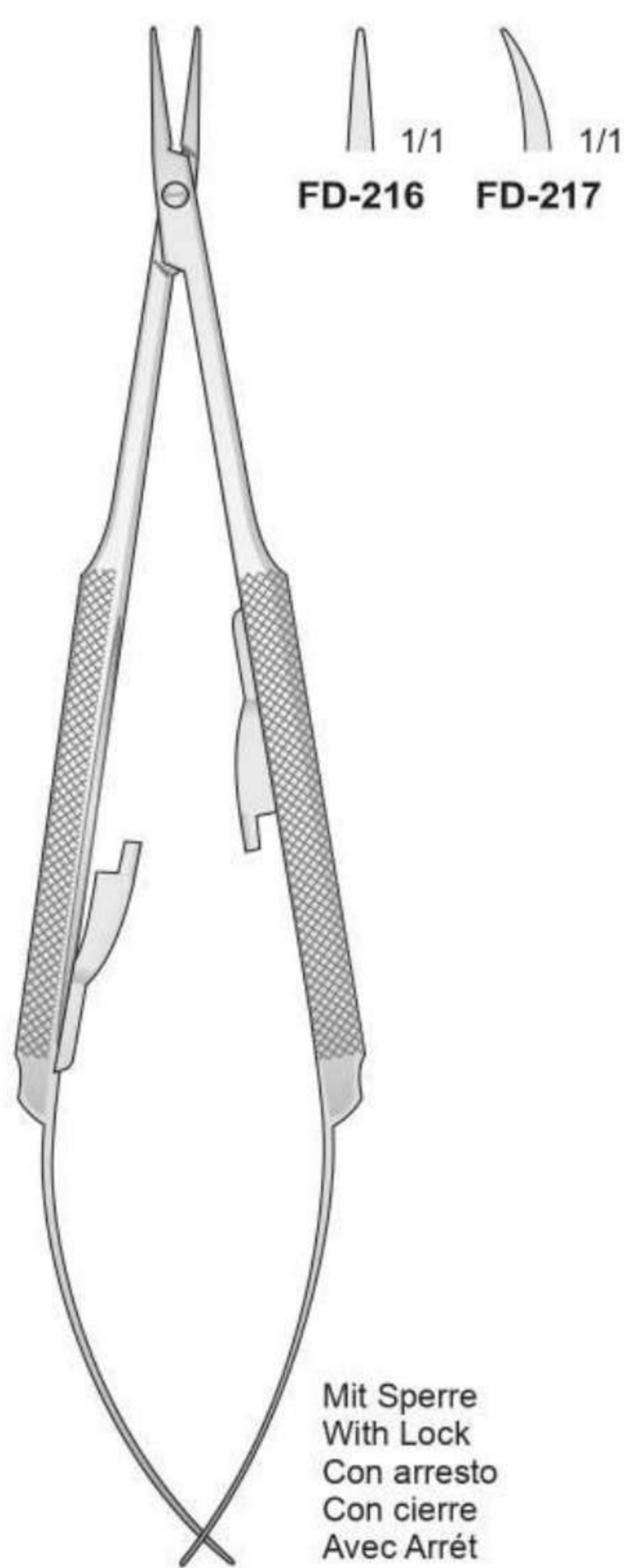

**BARRAQUER
FD-216/FD-217**
150 mm

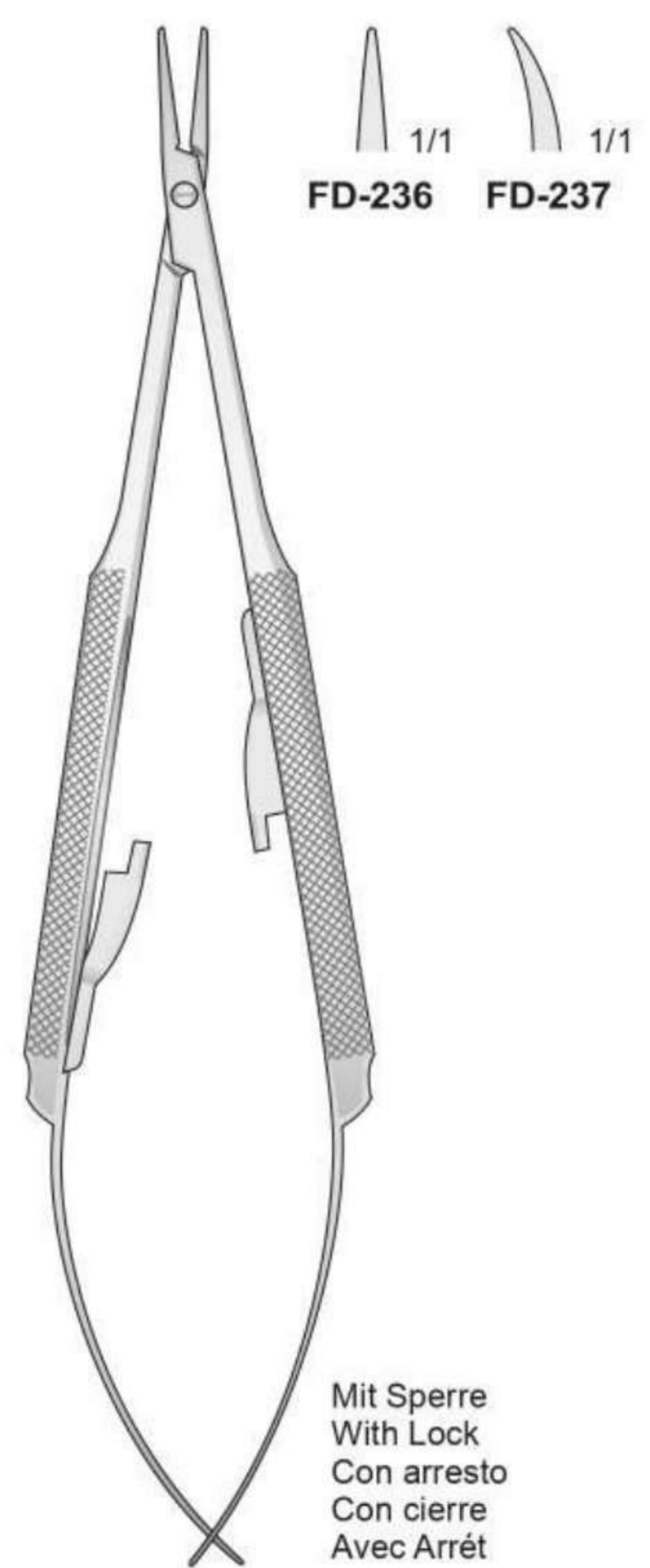

**BARRAQUER
FD-236/FD-237**
150 mm

Glattes Maul
Smooth jaws
Con morso liscio
Mandibula lisa
À mors lisses

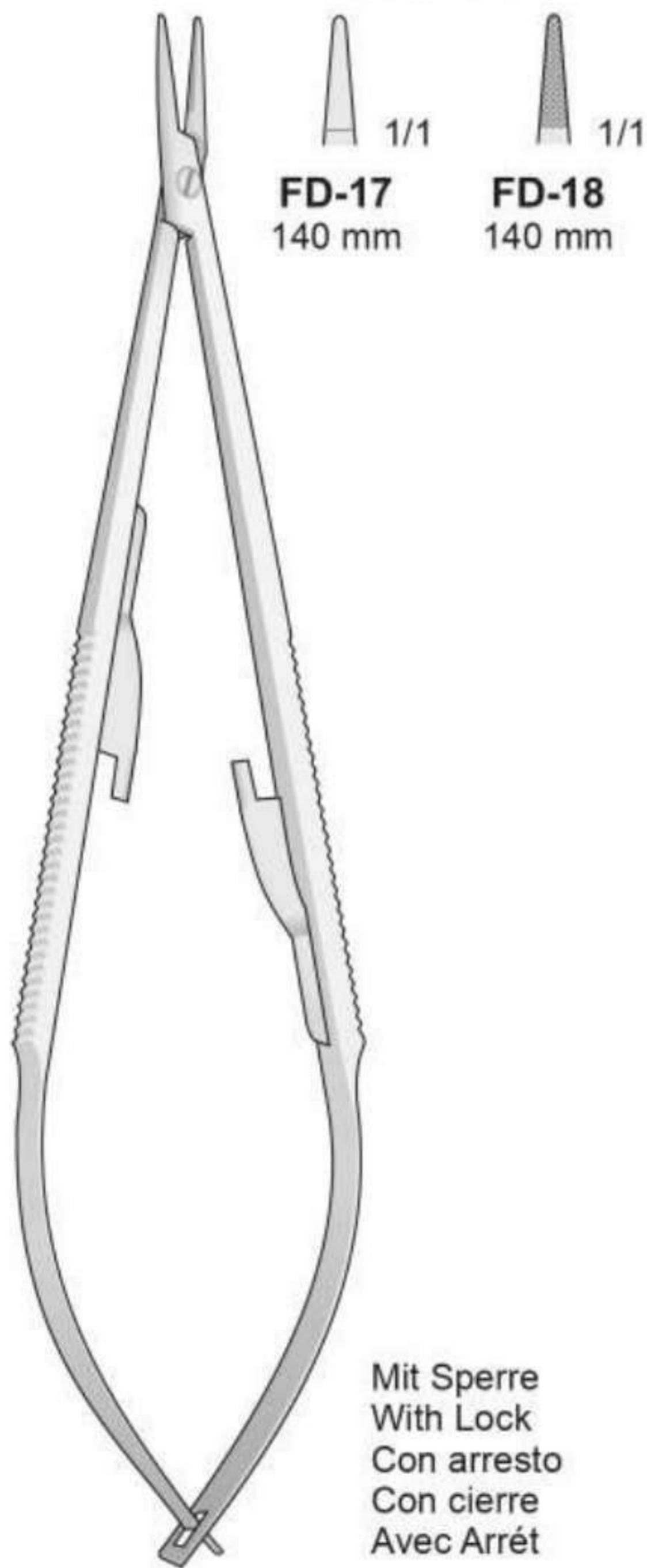

CASTROVIEJO
FD-17/FD-18
140 mm

TC

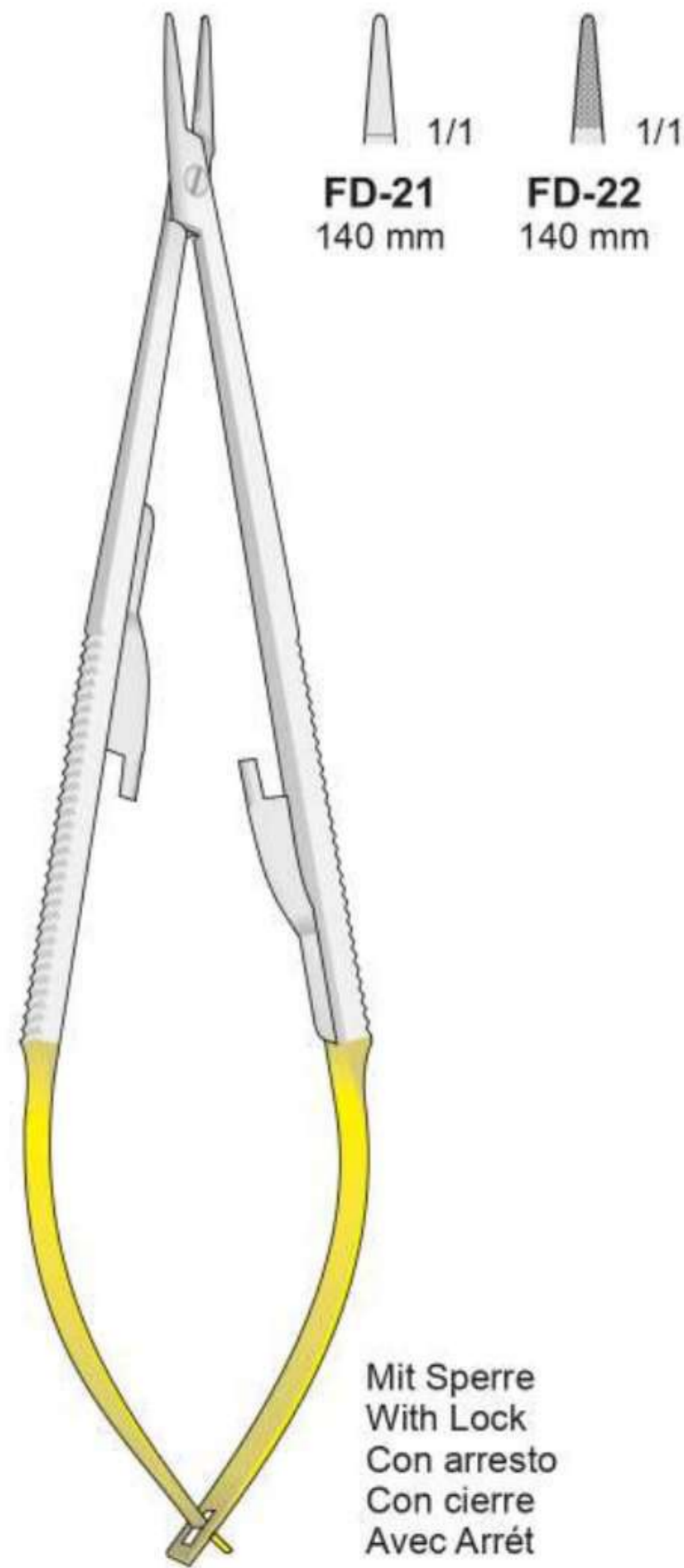

CASTROVIEJO
FD-21/FD-22
140 mm

TC

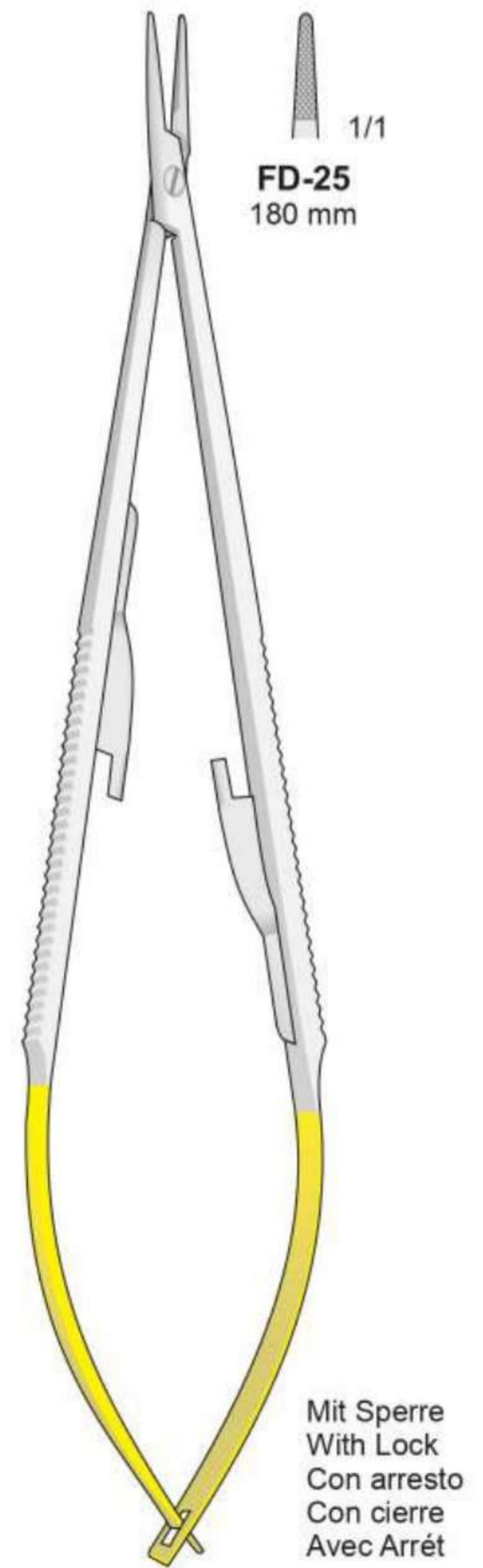

CASTROVIEJO
FD-25
180 mm

Nadelhalter

Needle Holders

Port'aghi

Porta-agujas

Porte-aiguilles

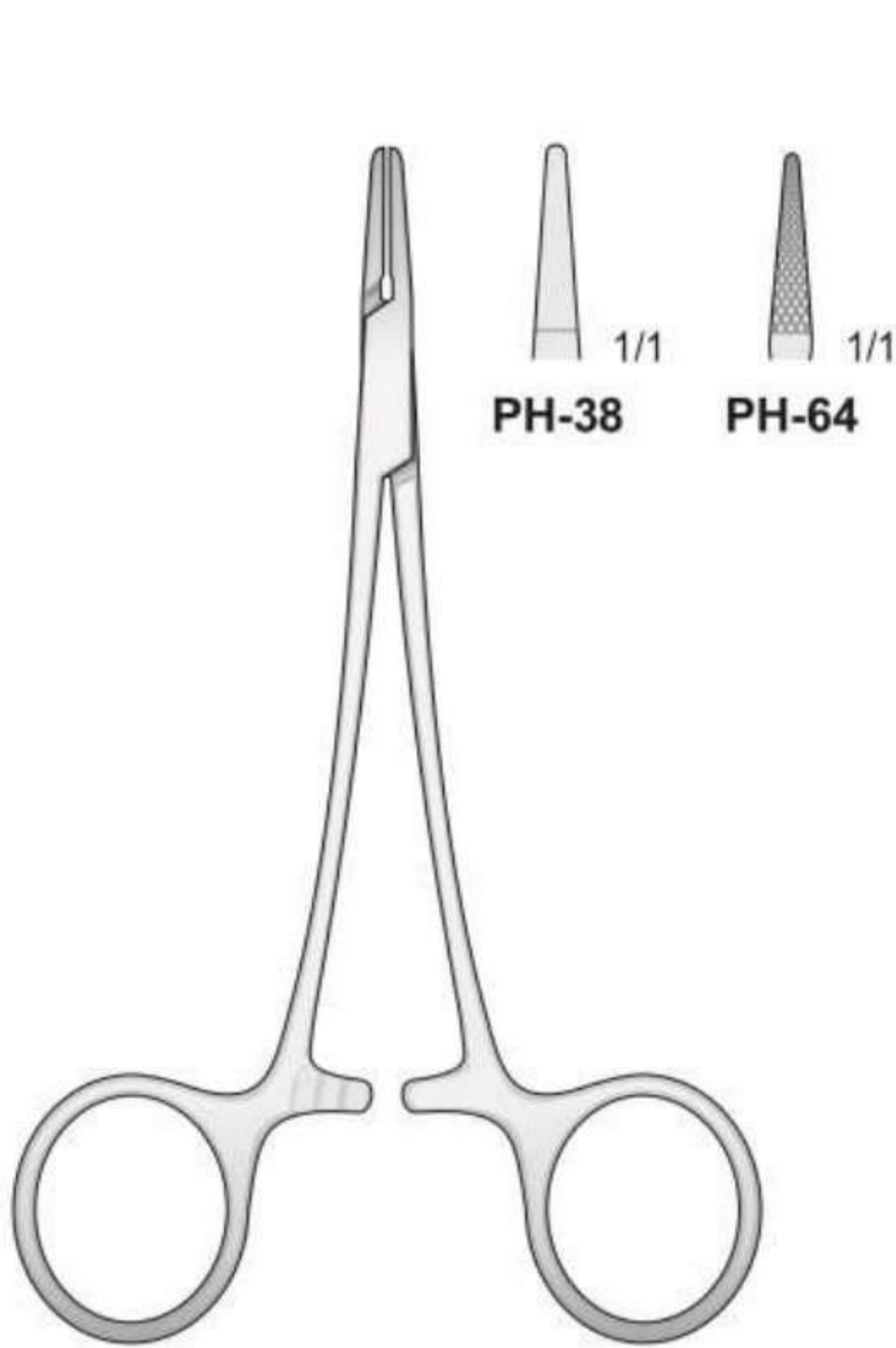

PH-38/PH-64
120 mm

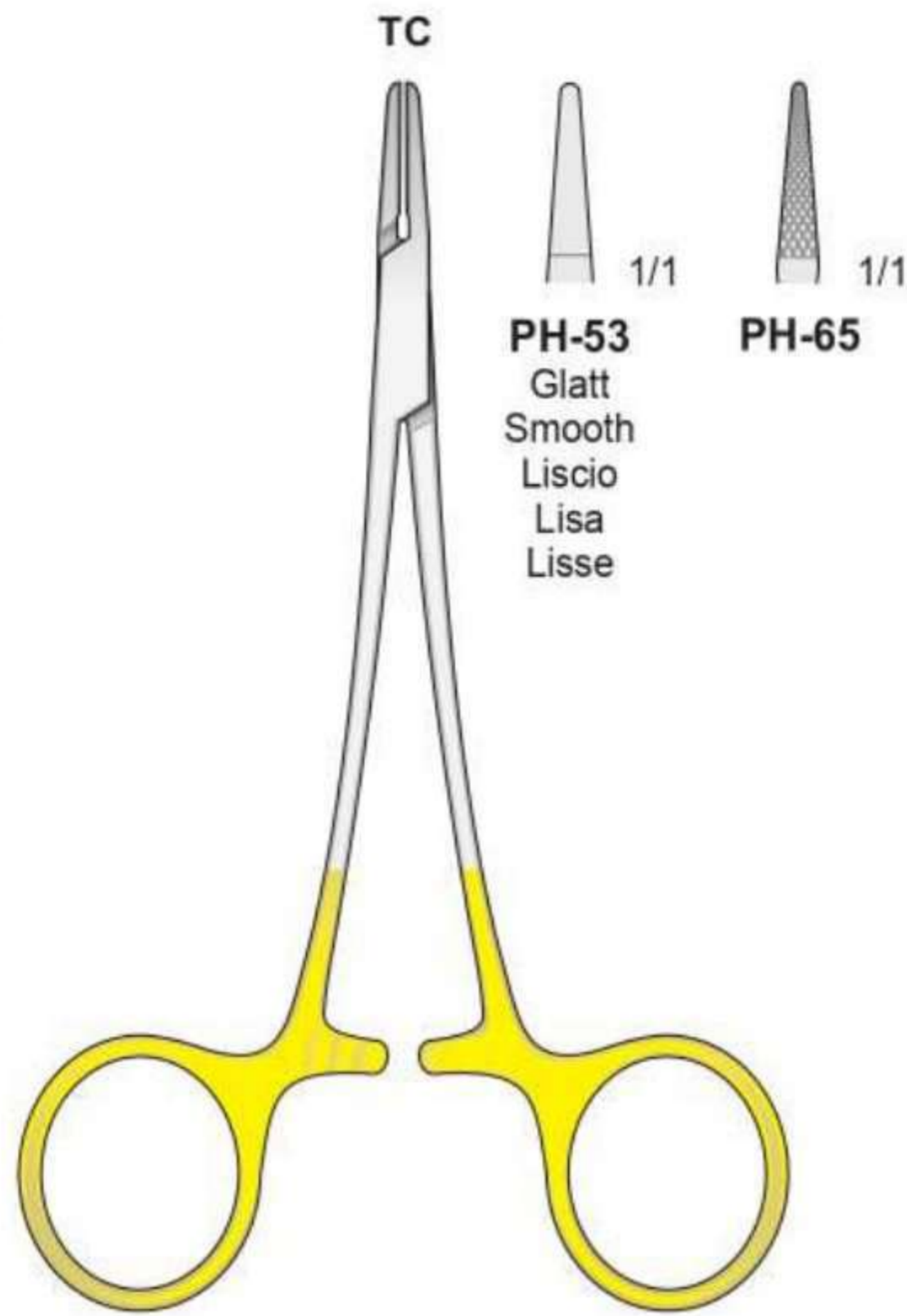

PH-53/PH-65
120 mm

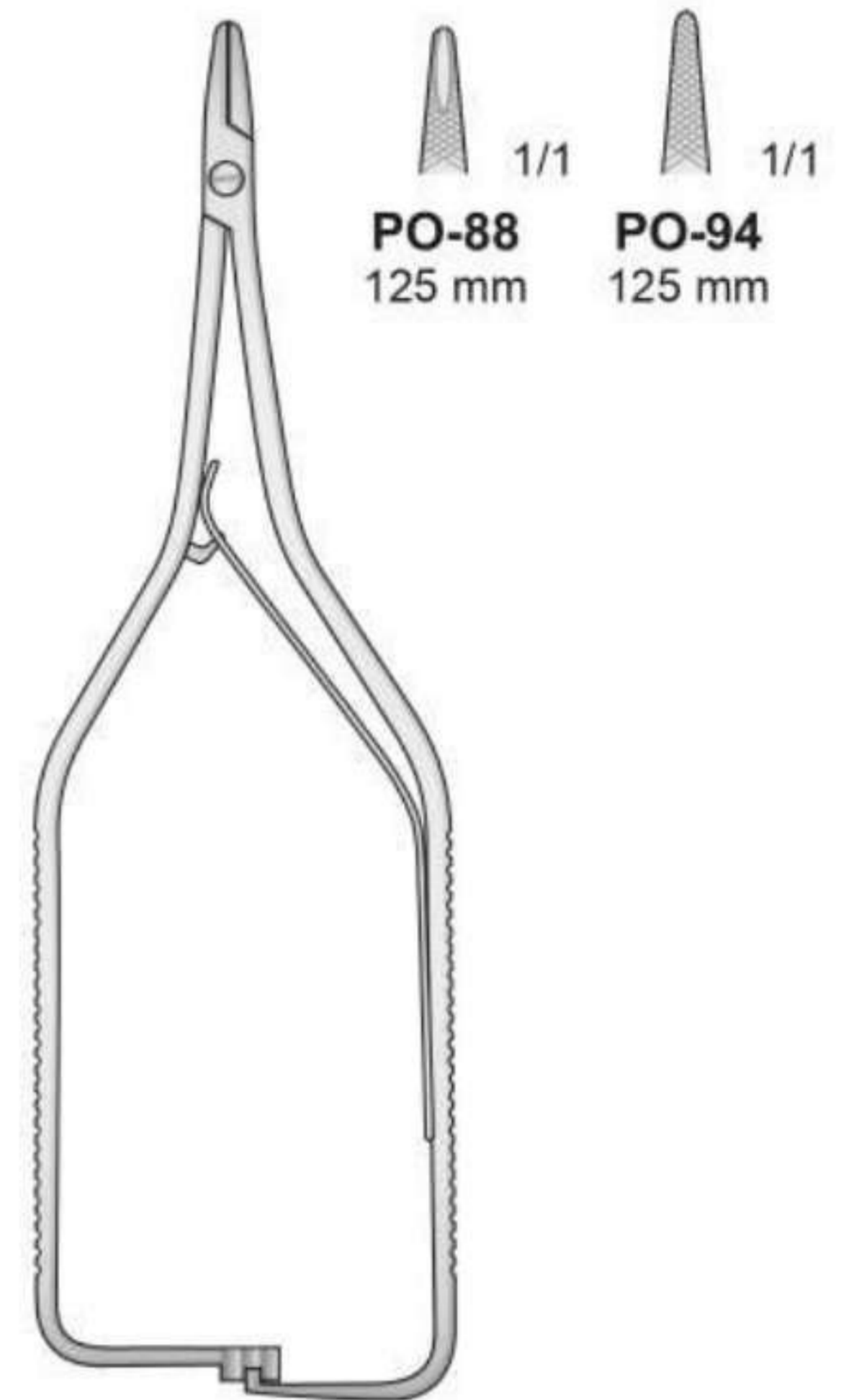

BOYNTON
PO-88/PO-94
125 mm

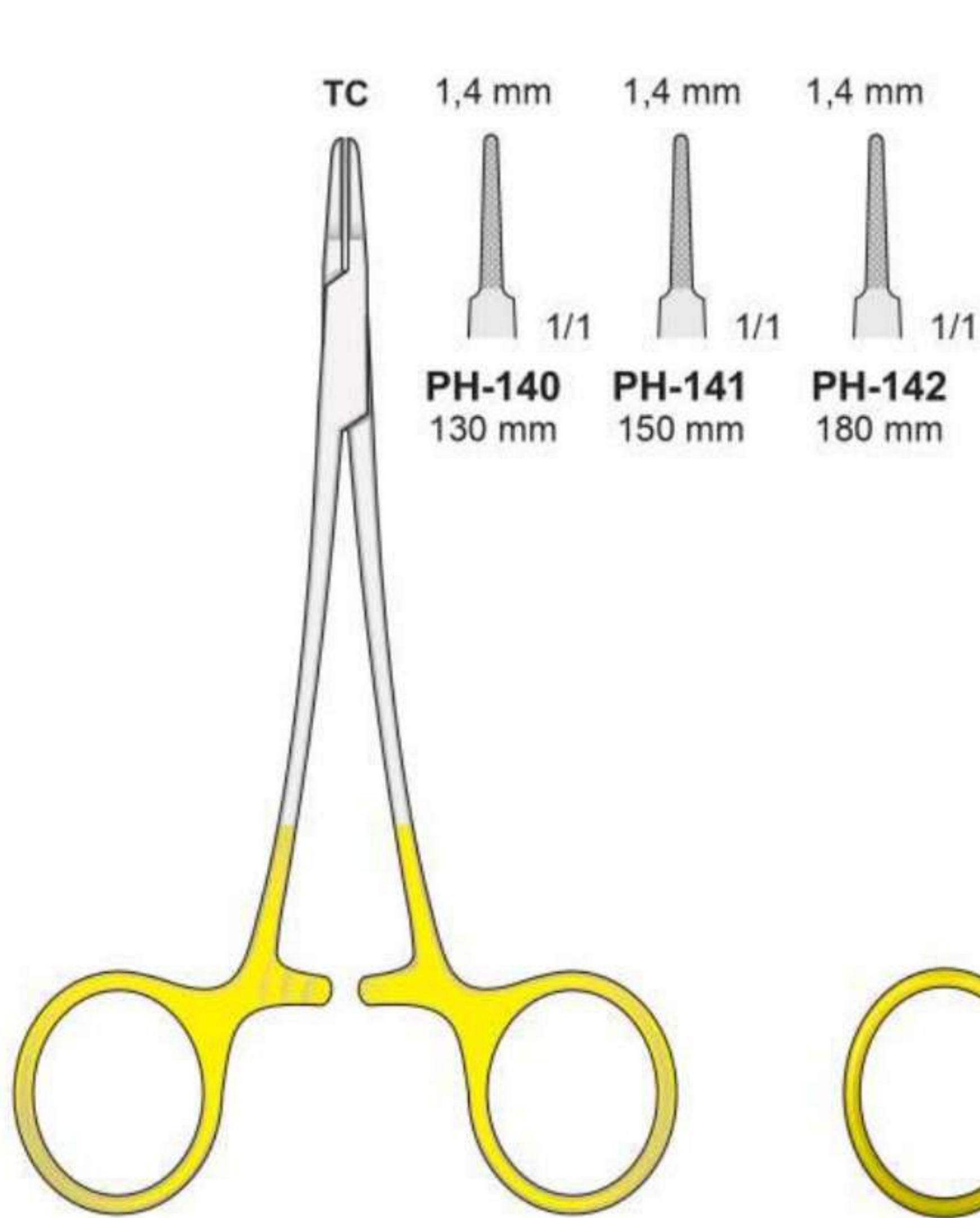

MICRO-RYDER
PH-140/PH-142

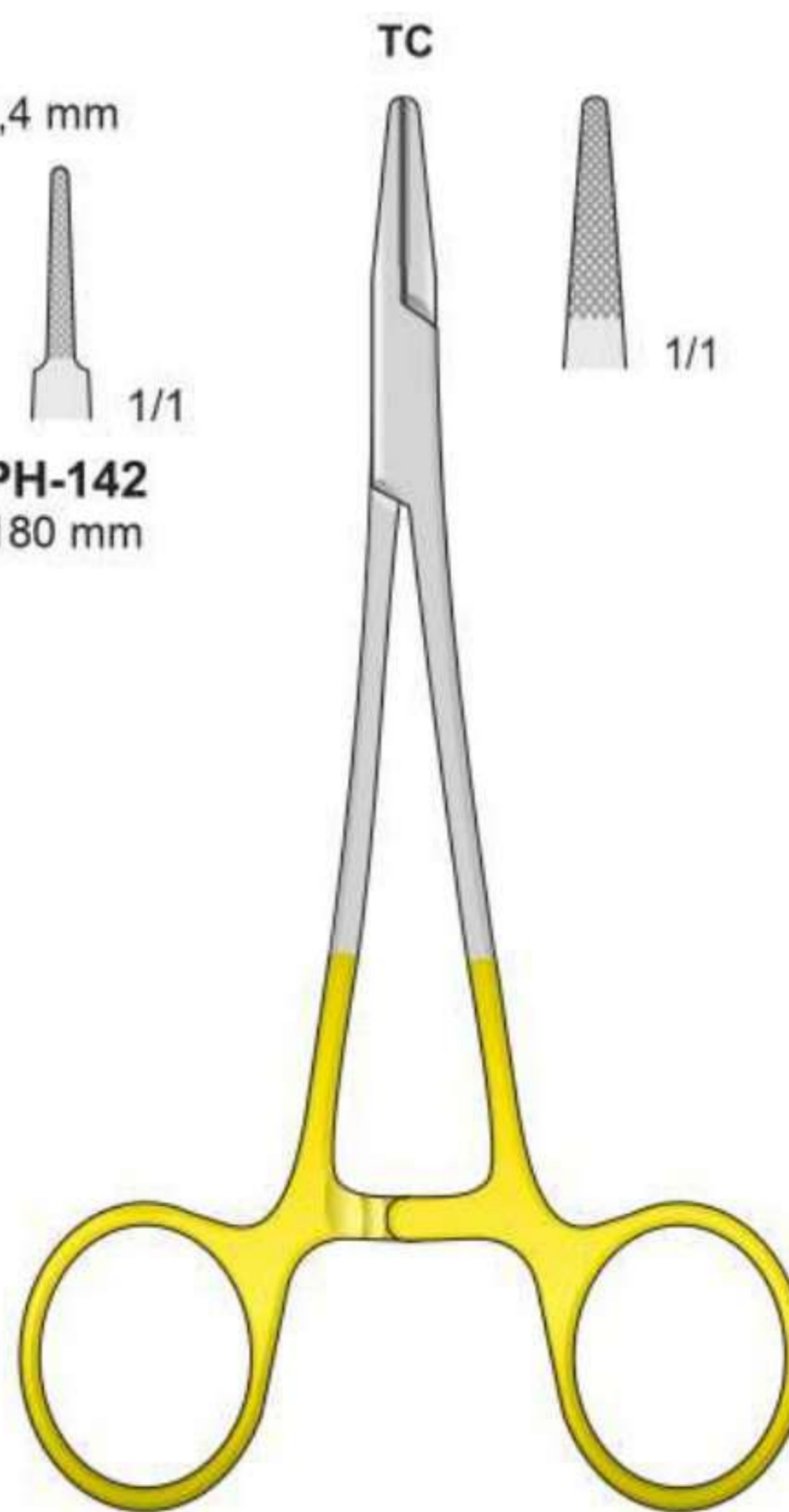

HALSEY
PH-73
130 mm

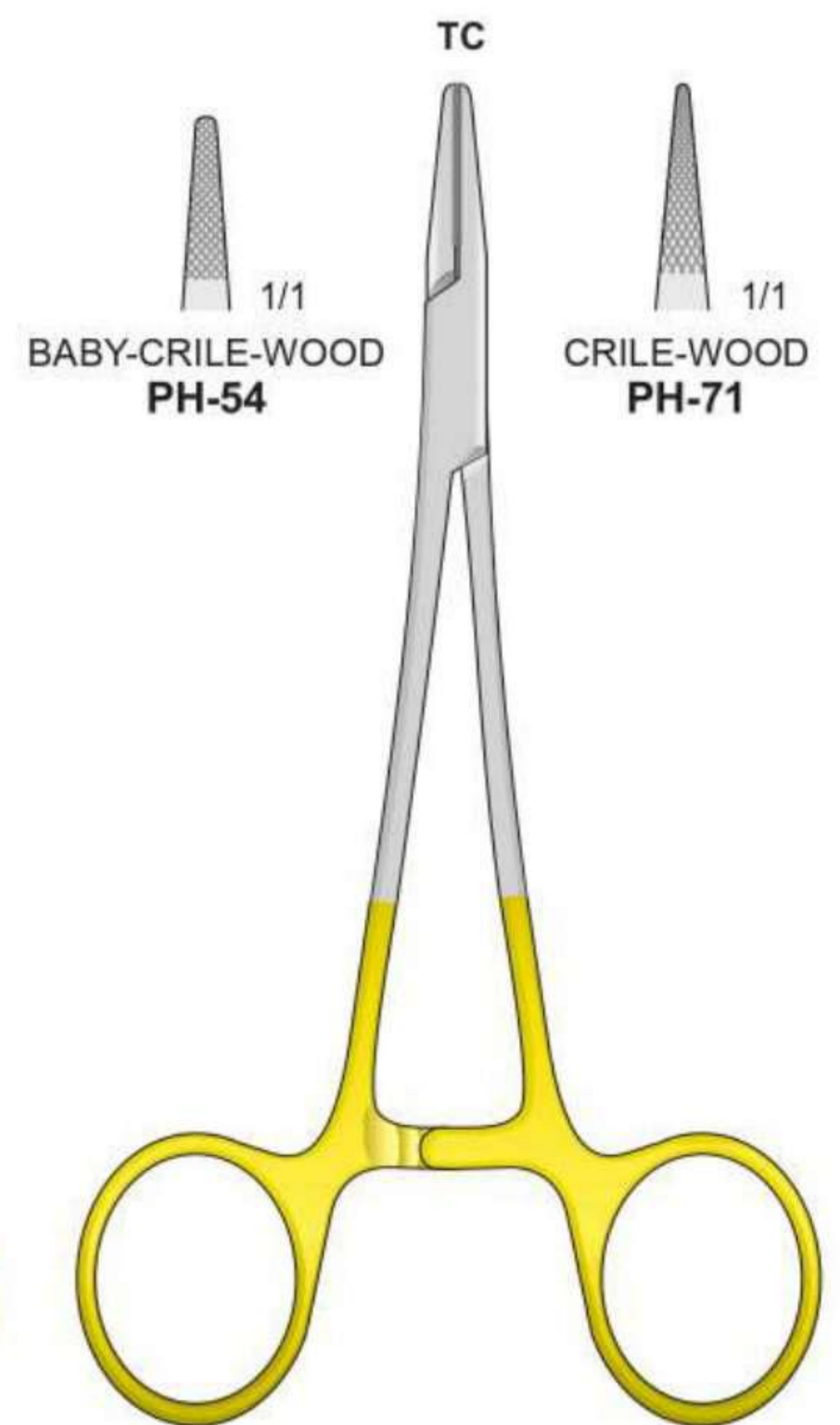

CRILE-WOOD
PH-54/PH-71
150 mm

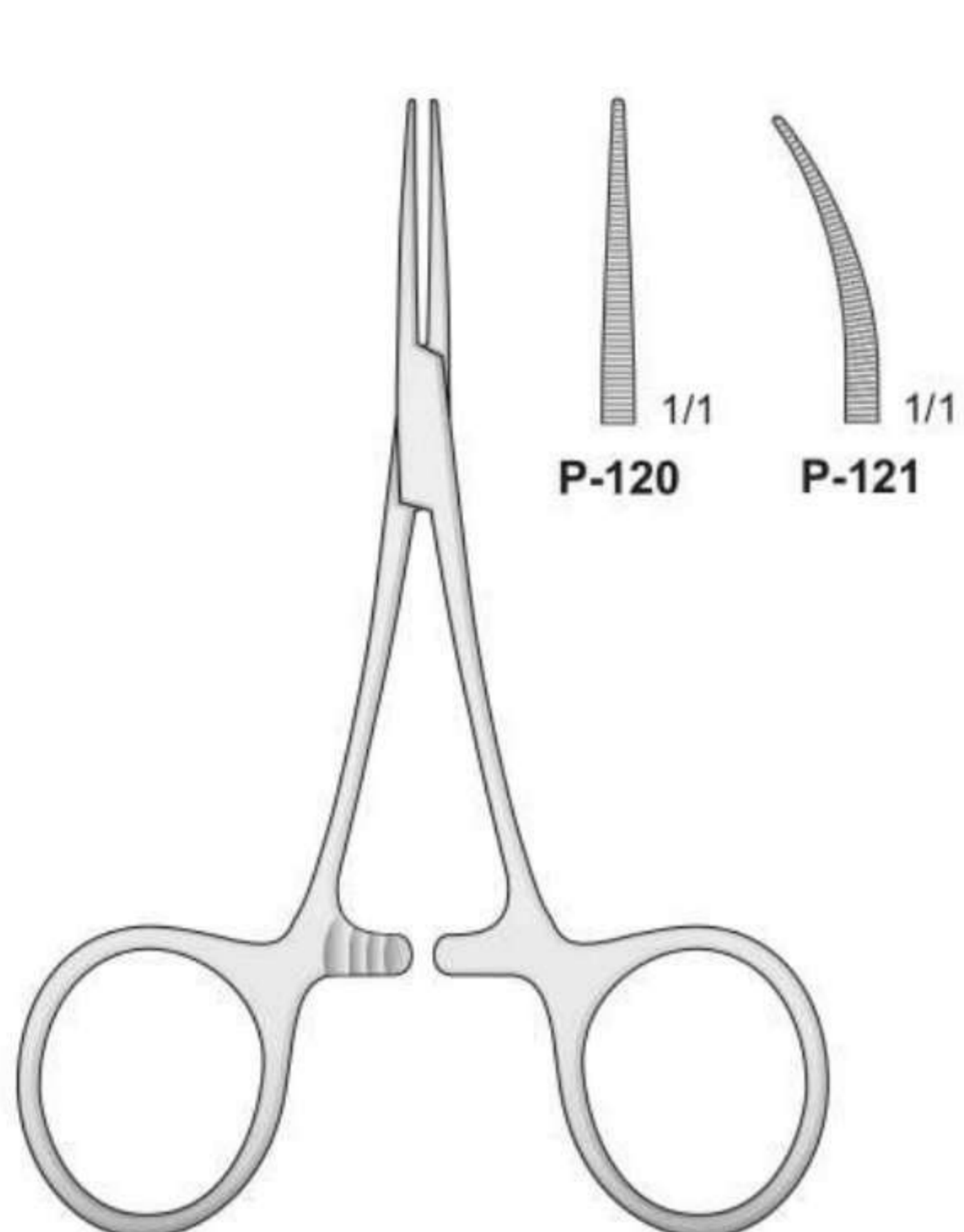

HARTMANN-BABY-MOSQUITO
P-120/P-121
 95 mm

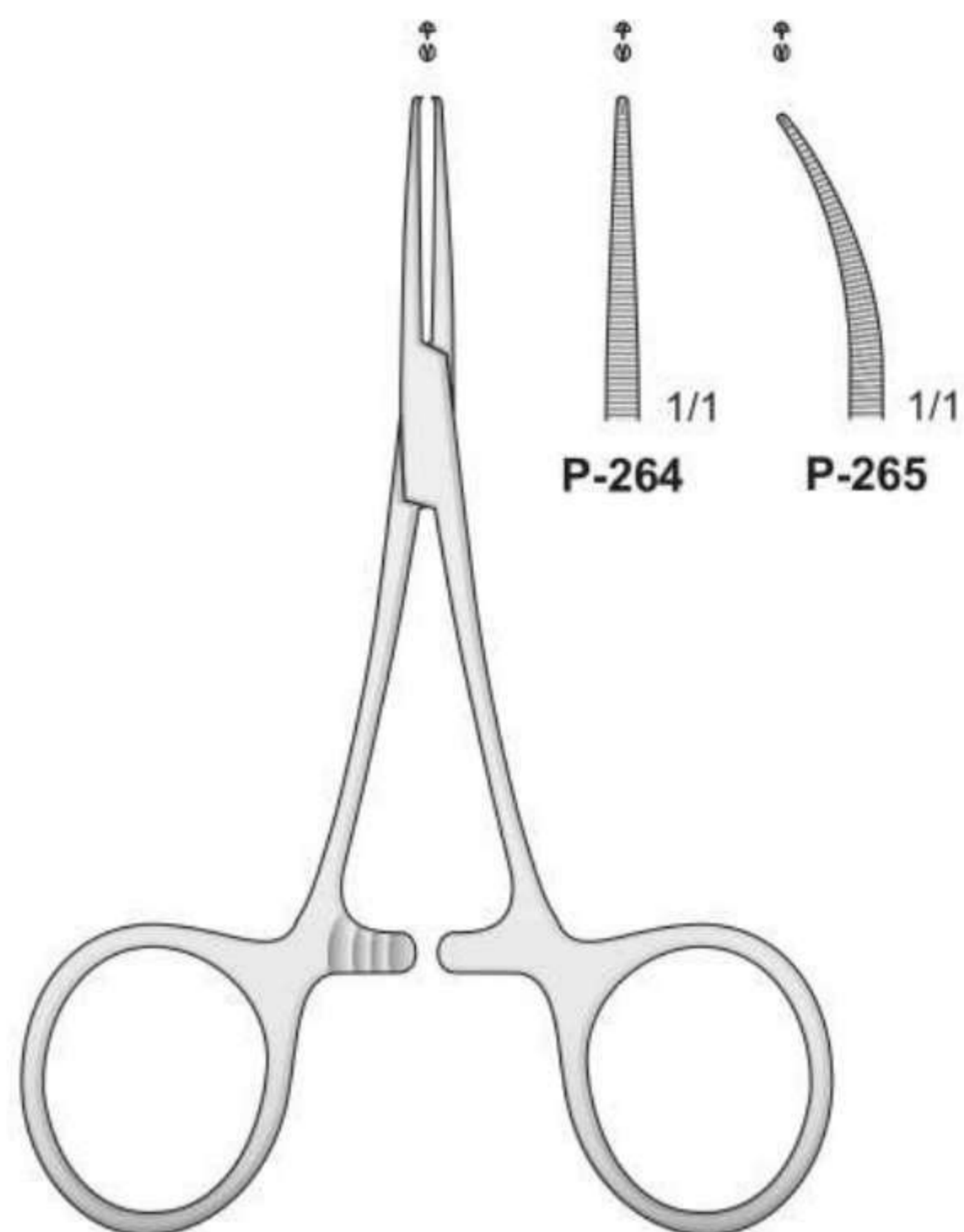

HARTMANN-BABY-MOSQUITO
P-264/P-265
 95 mm

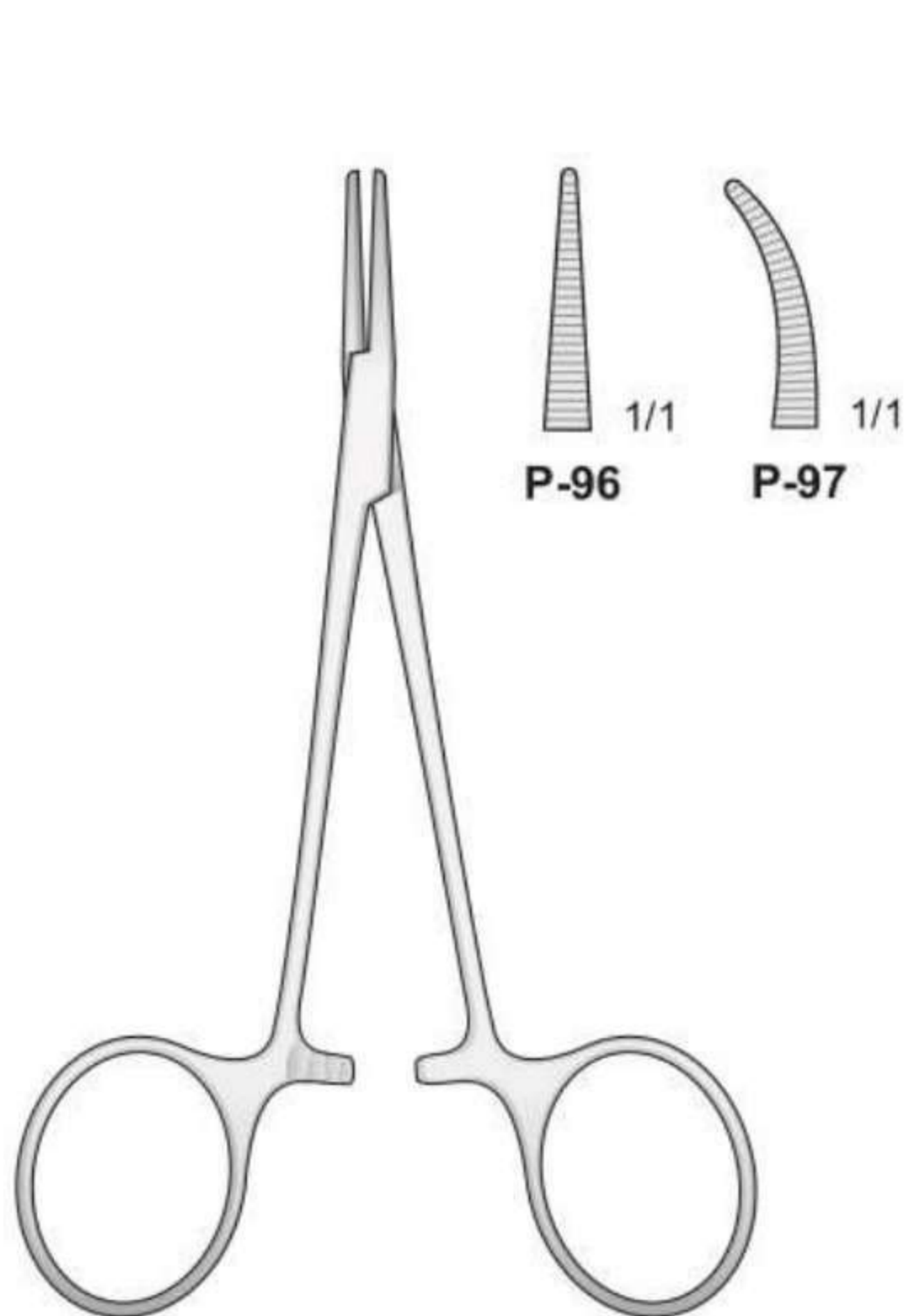

HALSTED-MOSQUITO
P-96/P-97
 120 mm

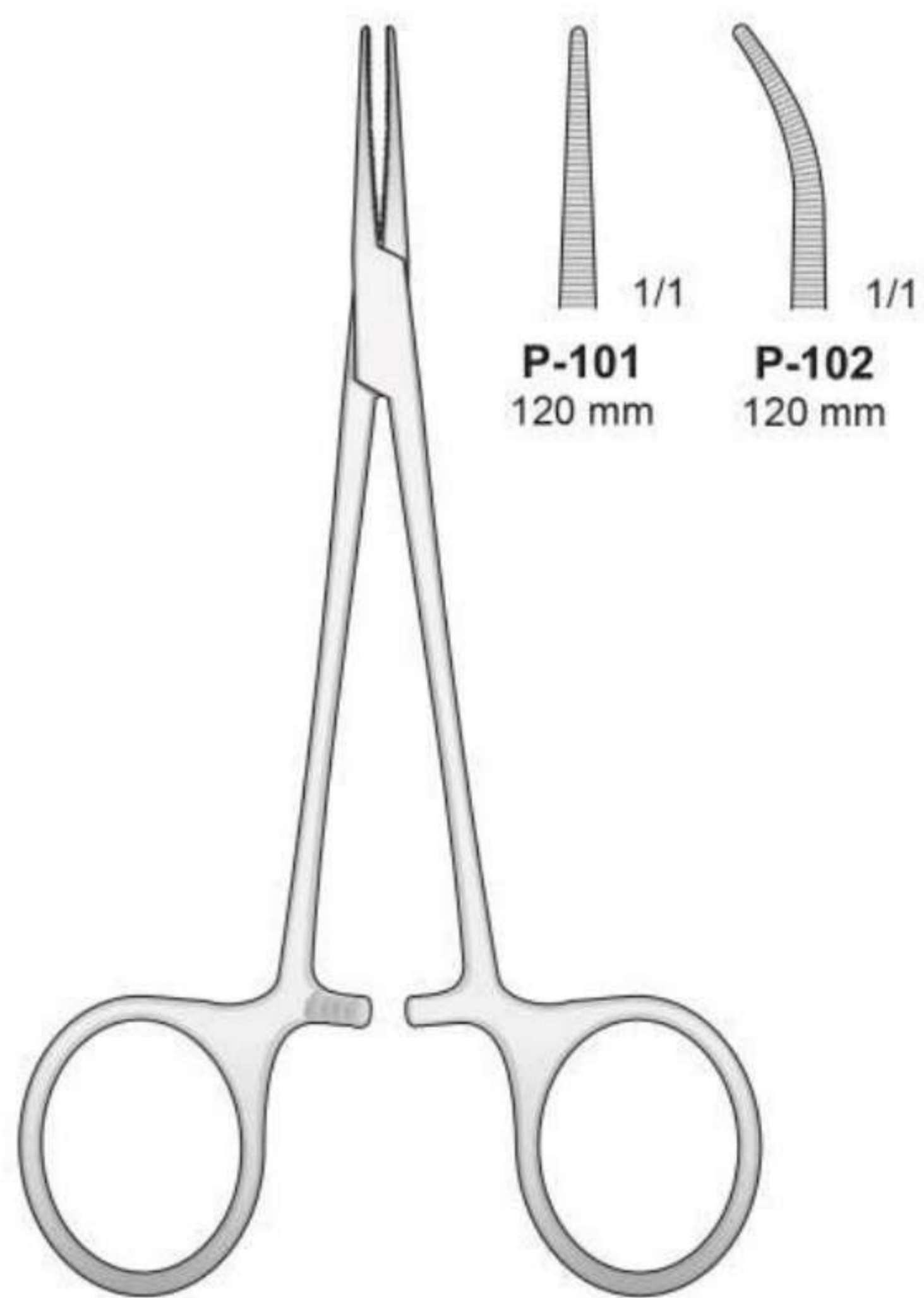

MICRO-HALSTED
P-101/P-102

4 x 5 Zähne
4 x 5 Teeth
4 x 5 Denti
4 x 5 Dientes
4 x 5 Dents

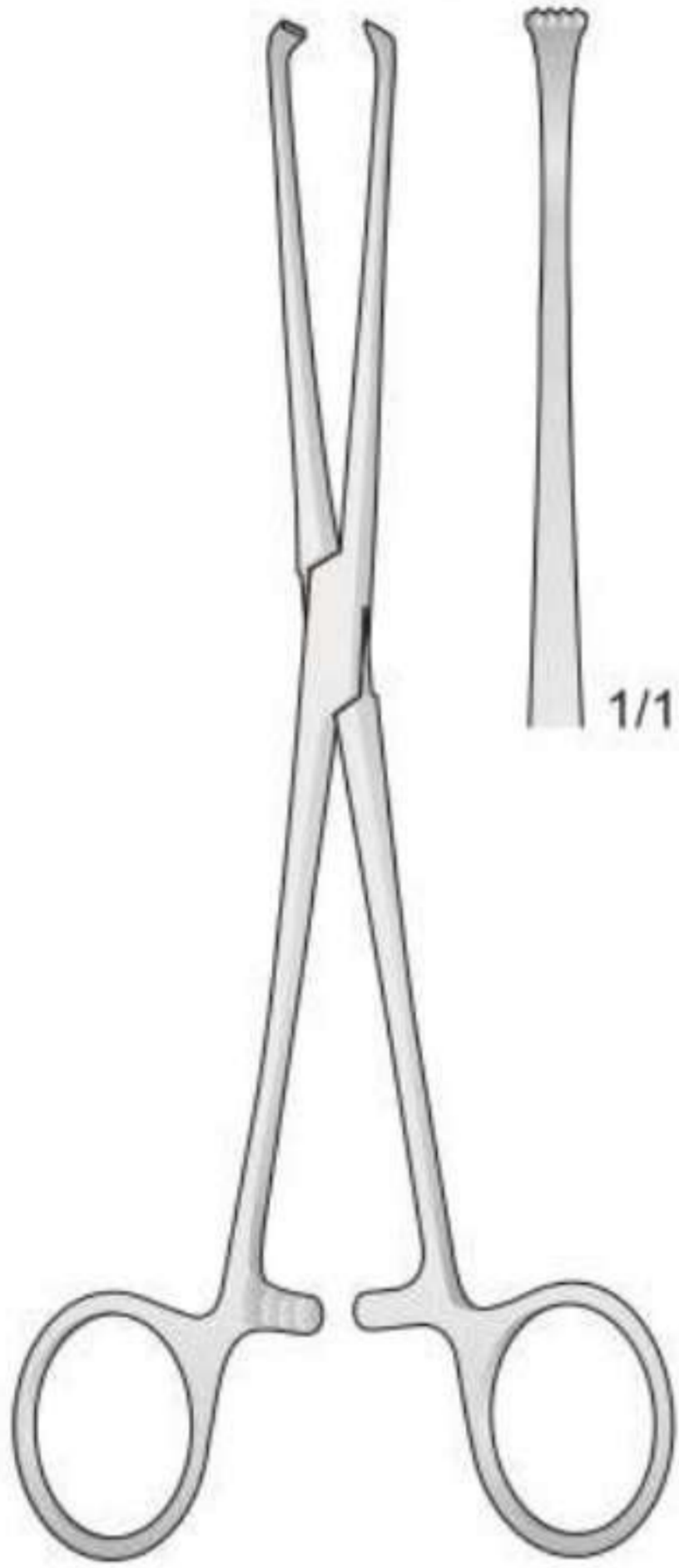

BABY-ALLIS
P-100
130 mm

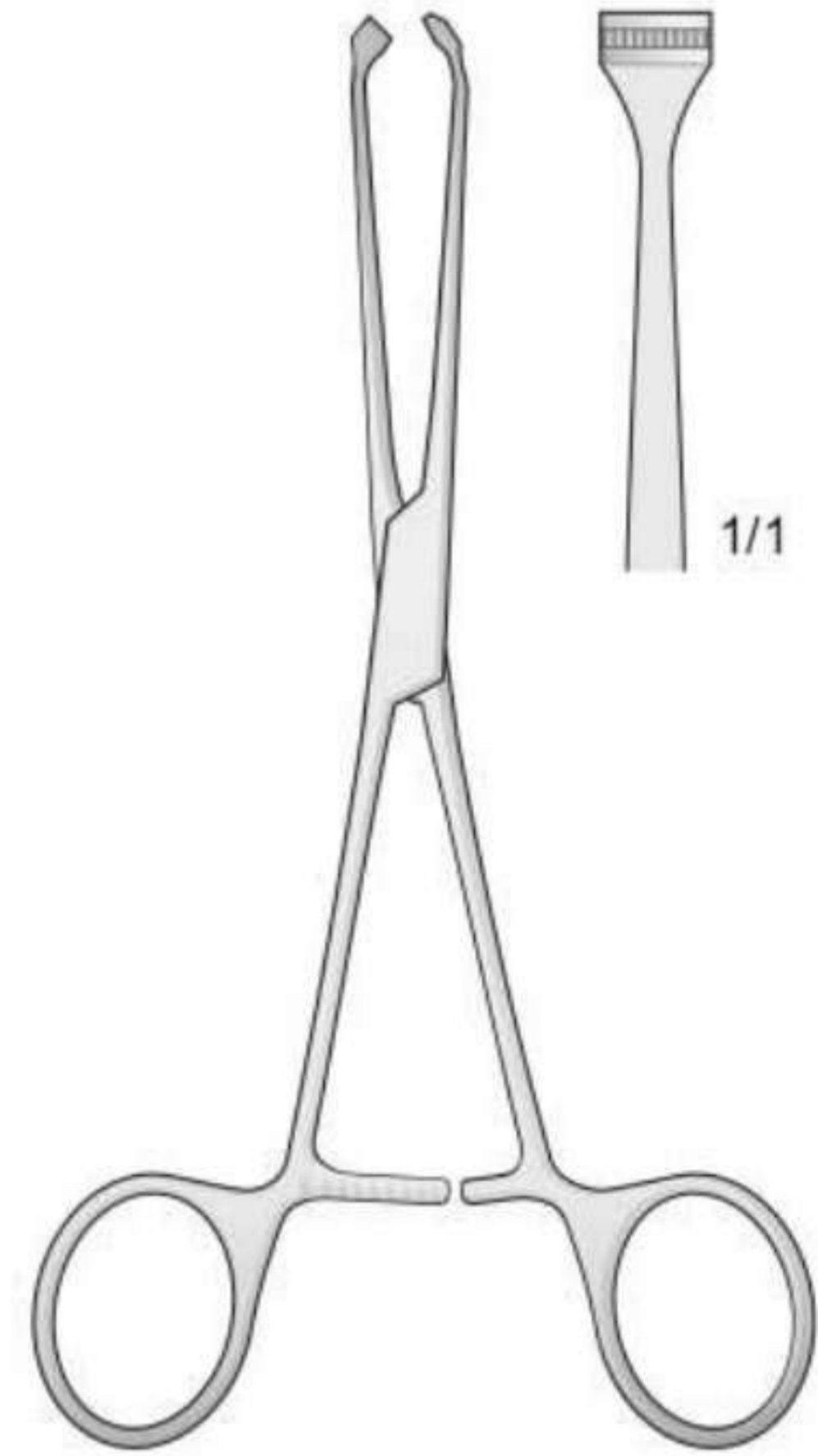

ALLIS
P-52
150 mm

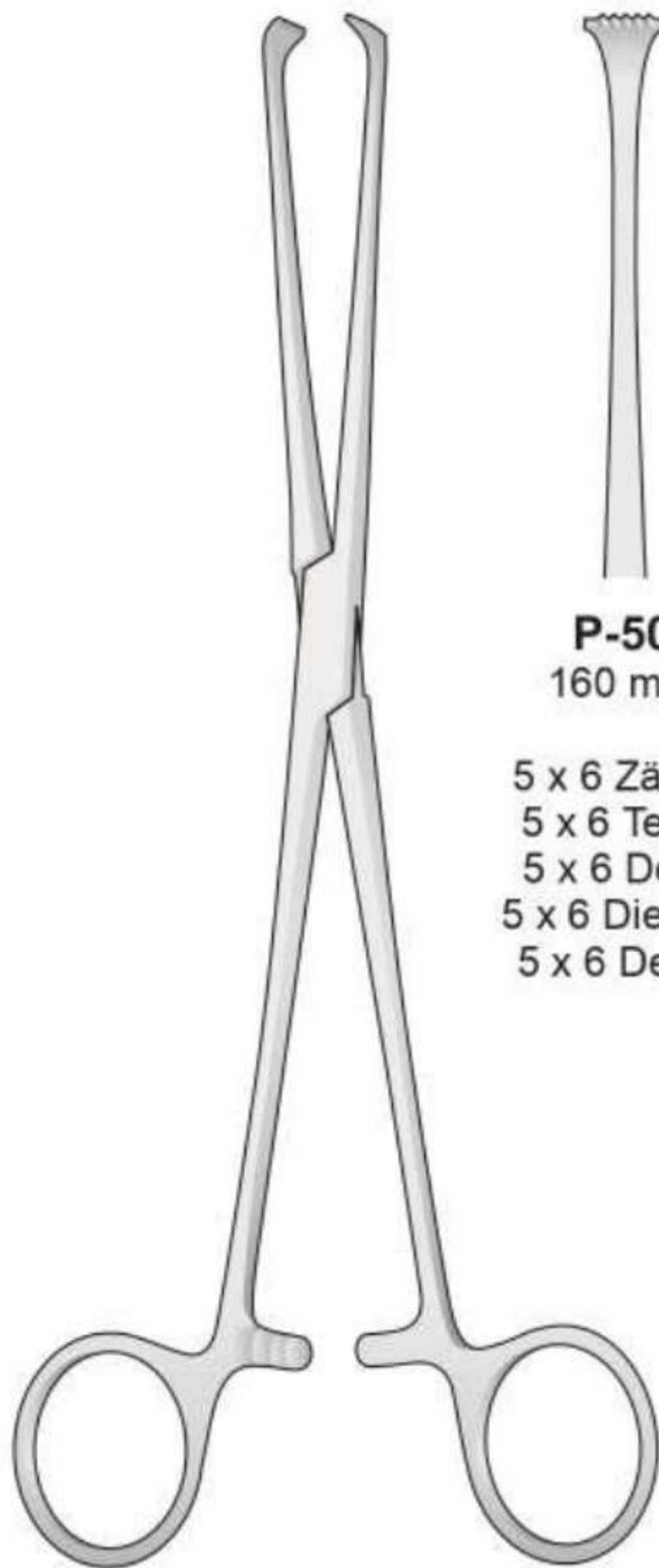

ALLIS
P-50/P-133

5 x 6 Zähne
5 x 6 Teeth
5 x 6 Denti
5 x 6 Dientes
5 x 6 Dents



P-50
160 mm

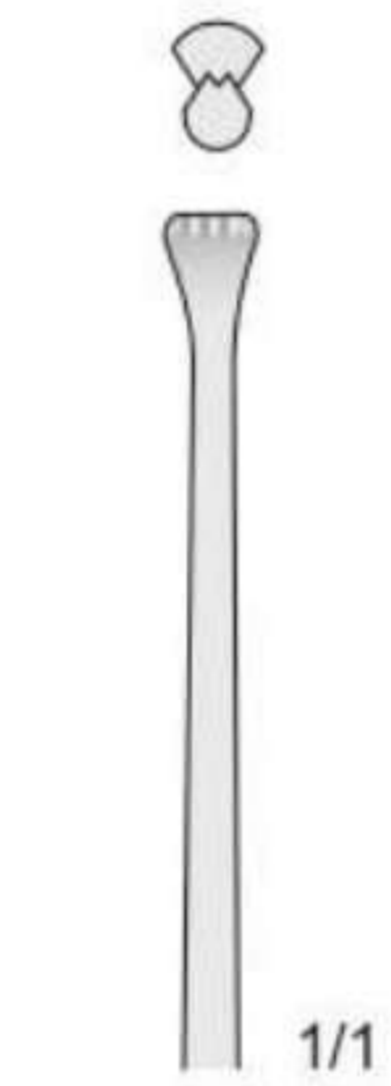

P-132
150 mm

2 x 3 Zähne
2 x 3 Teeth
2 x 3 Denti
2 x 3 Dientes
2 x 3 Dents

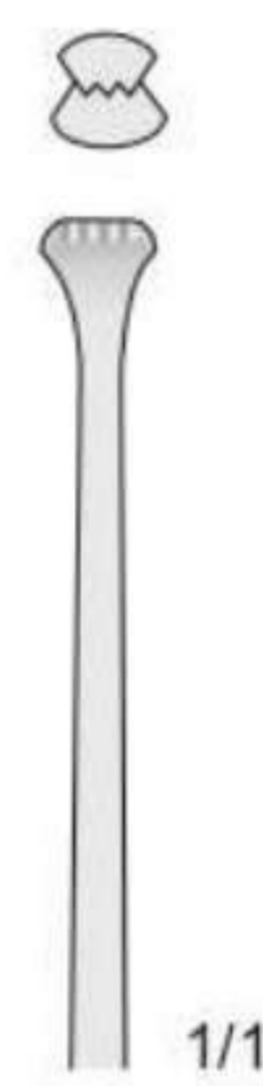

P-133
150 mm

3 x 4 Zähne
3 x 4 Teeth
3 x 4 Denti
3 x 4 Dientes
3 x 4 Dents

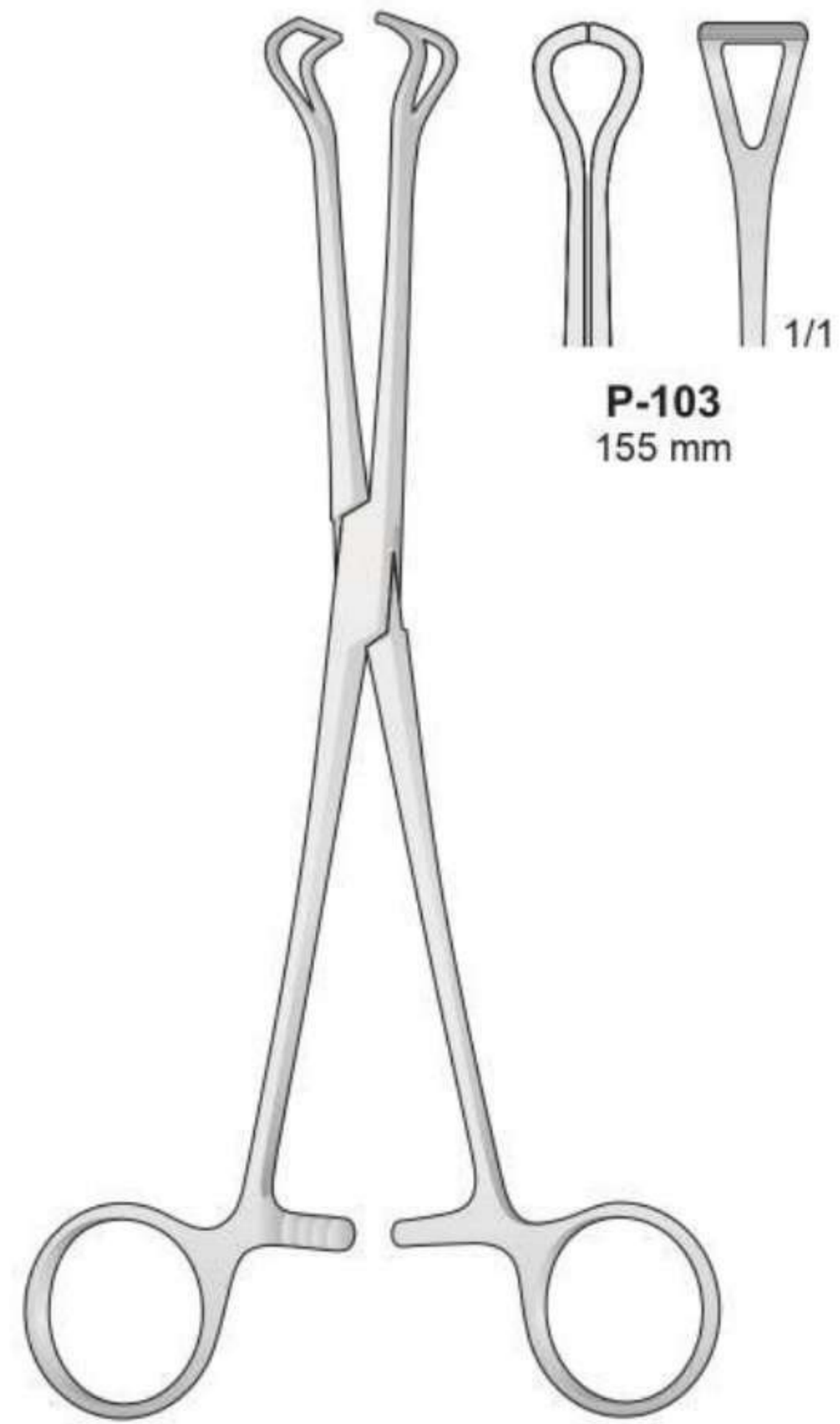

BABCOCK
P-103

P-103
155 mm

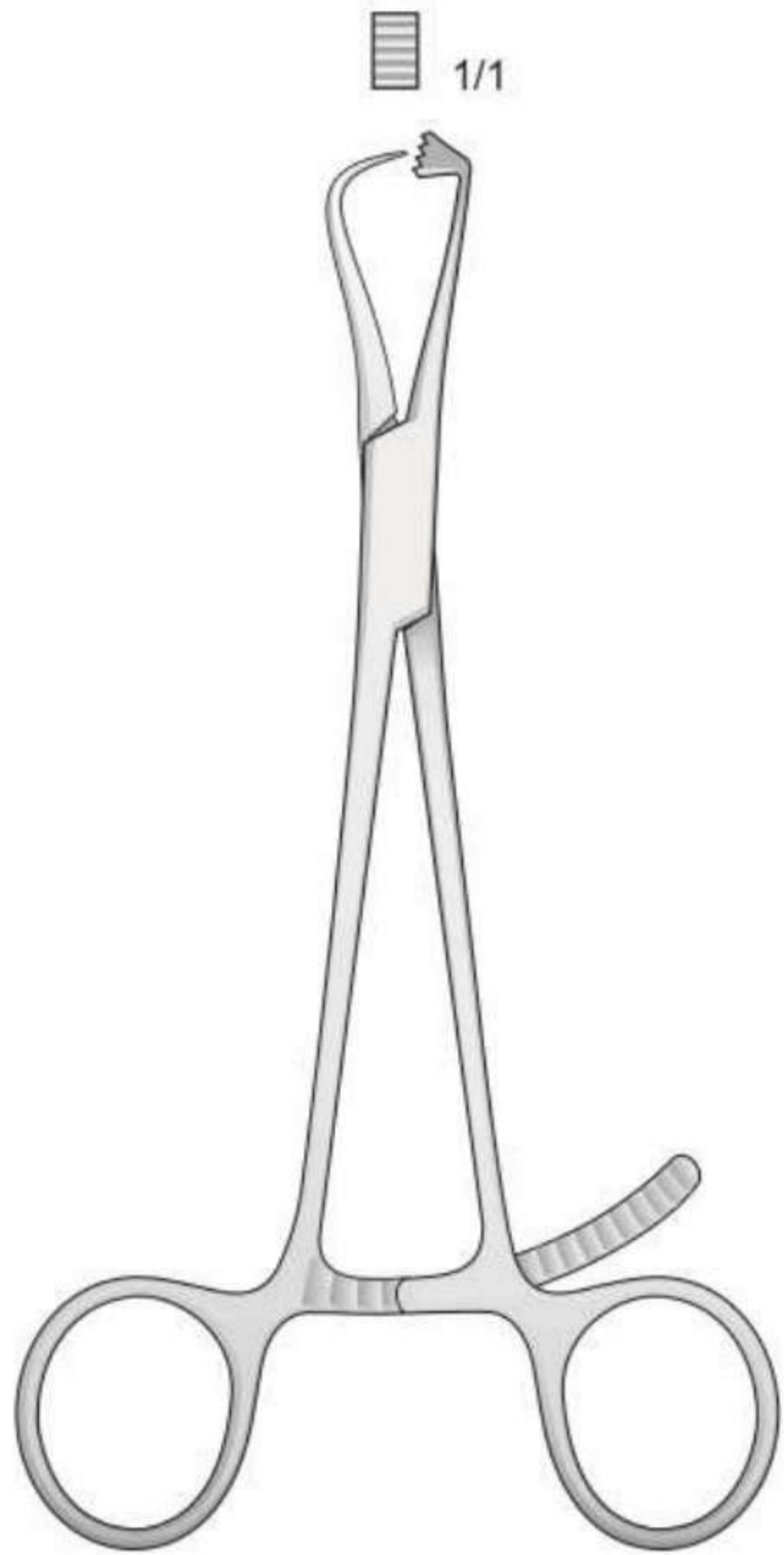

LS-78L
125 mm

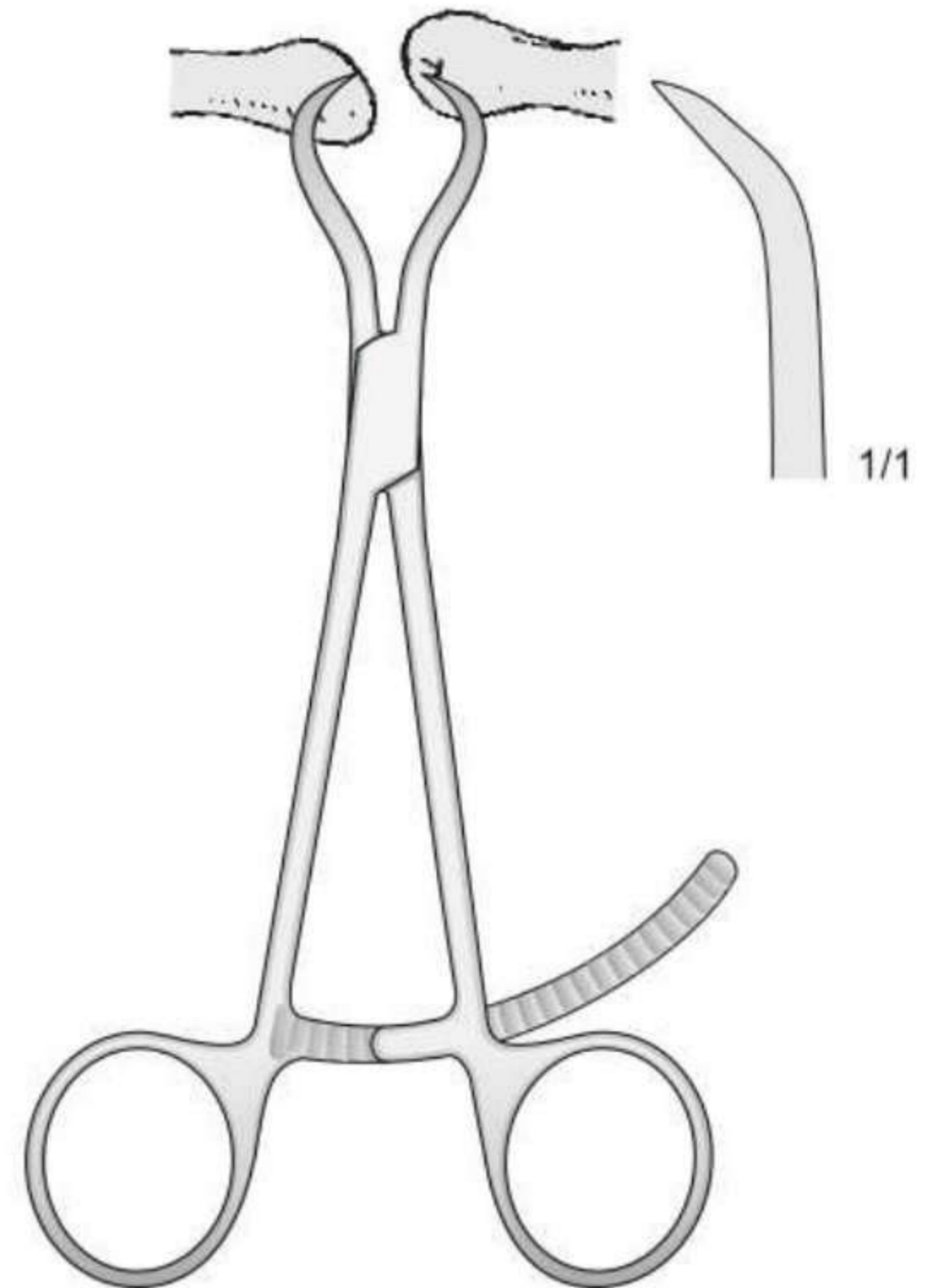

FO-66L
135 mm

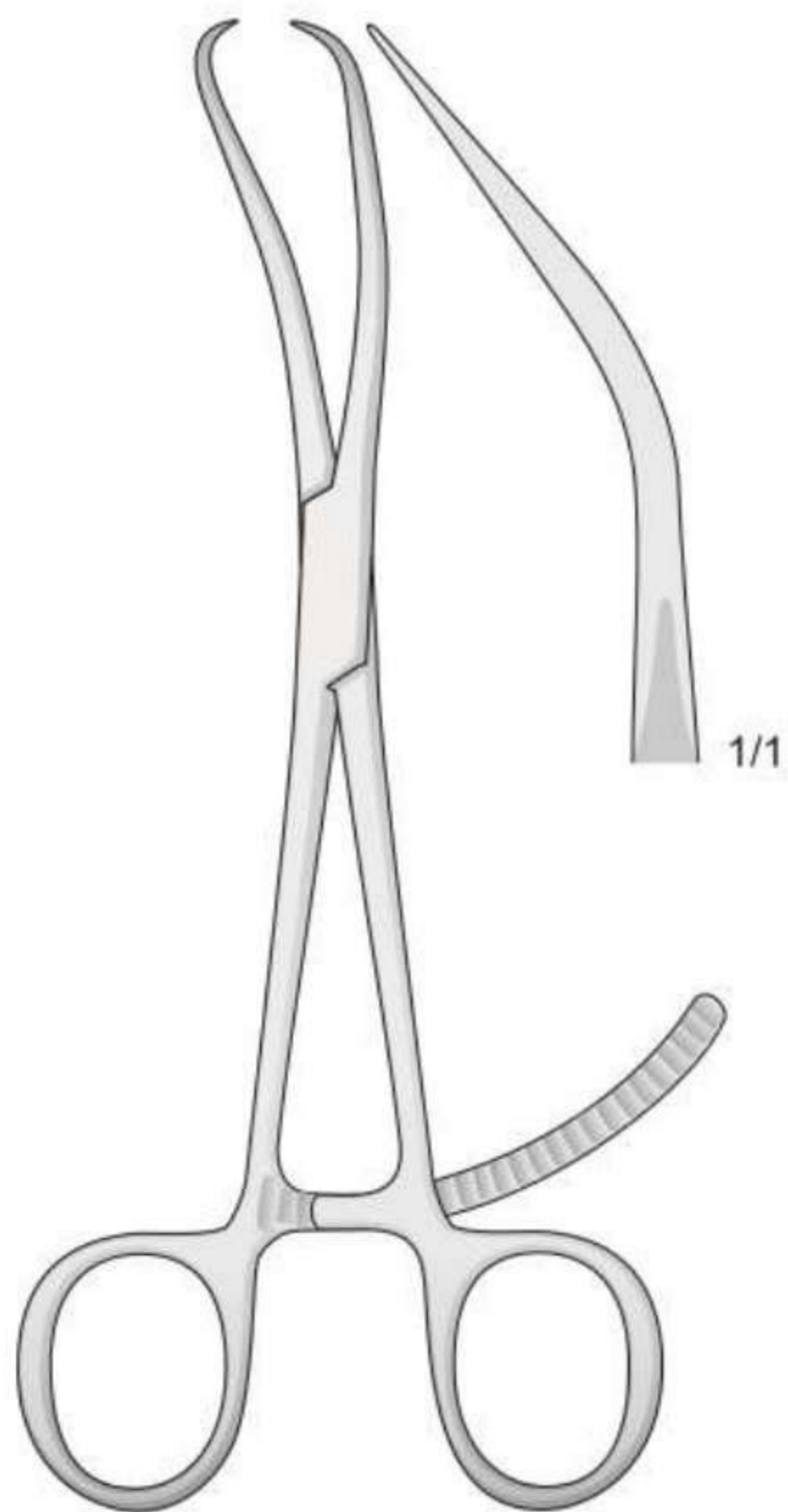

REILL
FO-64L
170 mm

Pinza con cremagliera
Forceps with ratchet fixation
Zange mit Zahnsperre
Davier à crémaillère

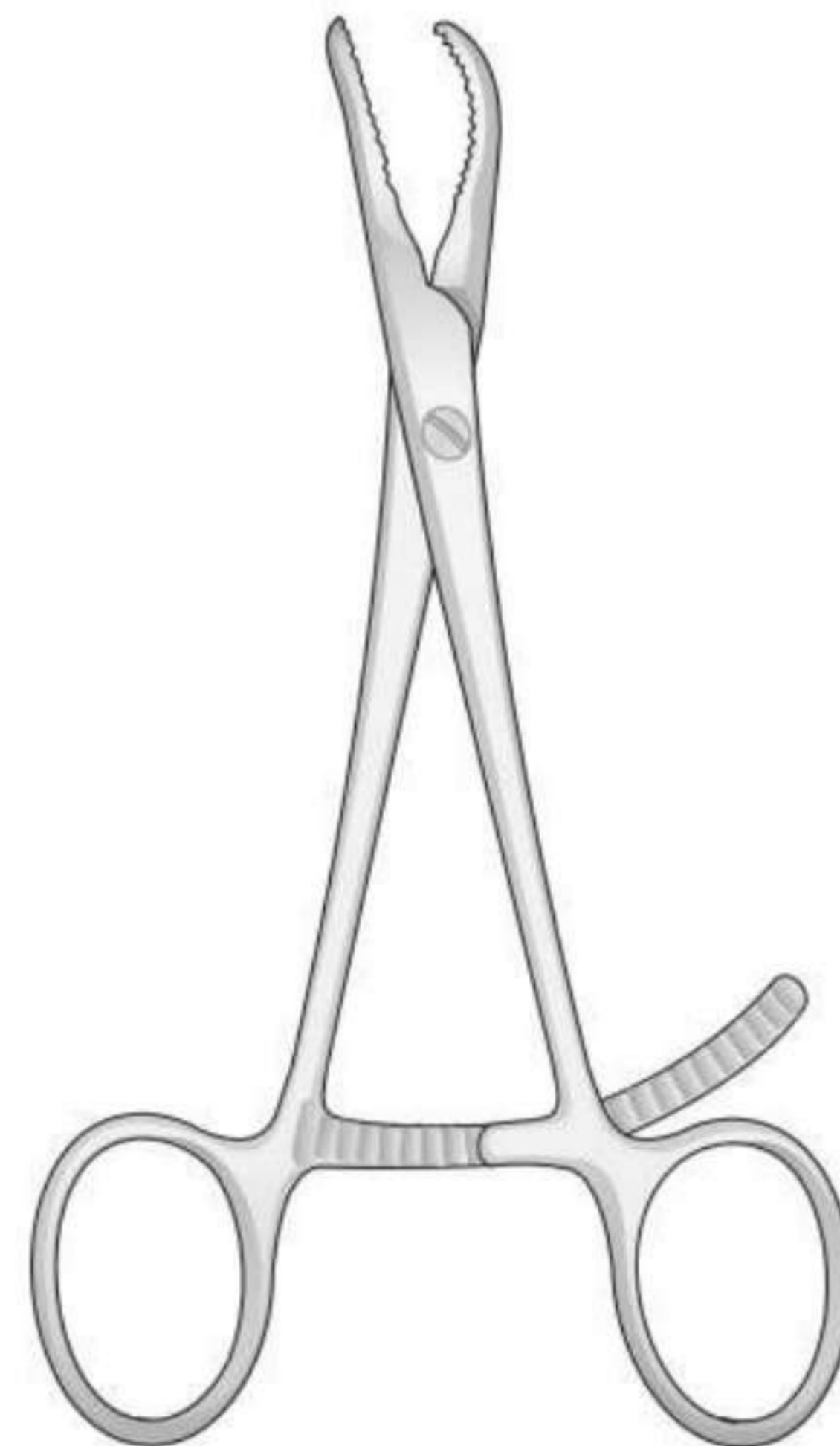

FO-47L
140 mm

Welcome to TRS Instruments a leading manufacturer of cutting-edge dental instruments dedicated to elevating oral healthcare standards worldwide. Our meticulously crafted instruments are designed to empower dental professionals with precision and innovation. From diagnostic tools enabling accurate assessments to surgical instruments facilitating complex procedures, our comprehensive range covers all aspects of modern dentistry. With a commitment to quality, our instruments are engineered from premium materials, ensuring durability and patient safety. At TRS Instruments, we take pride in contributing to the success of dental practices by providing reliable tools that meet the evolving demands of the industry. Discover excellence in dental instrumentation with TRS Instruments.



Info@trsstruments.com



+92-301-9643745



+92-523305268



1, Bhinder, Tasleem Pura, Sialkot Pakistan